

| | | | | | |
|---------|------|----|----|----------------|-----------------|
| 版次 0 | 变更摘要 | 日期 | 序号 | 品名 | 材质 |
| | | | ① | MX3.0双排直针WTB胶芯 | PA66 UL94V-0 黑色 |
| | | | ② | MX3.0双排直针WTB端子 | 铜合金/表面镀锡 |

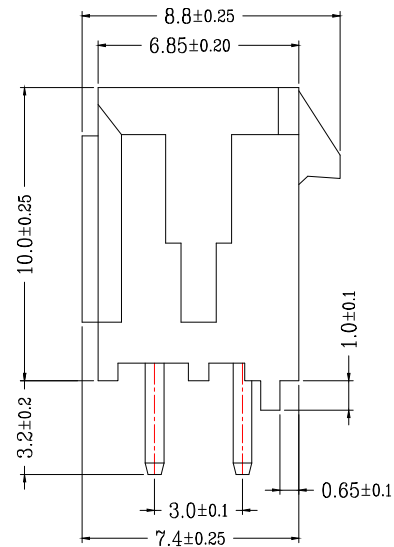

TYPE 1(无K脚)

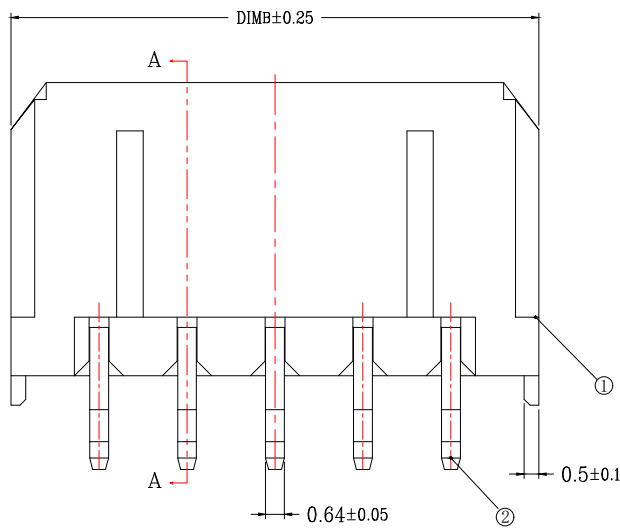
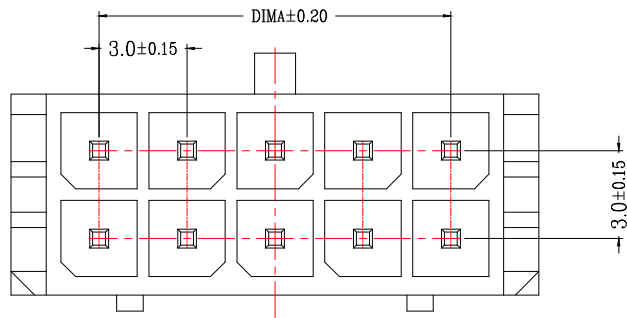
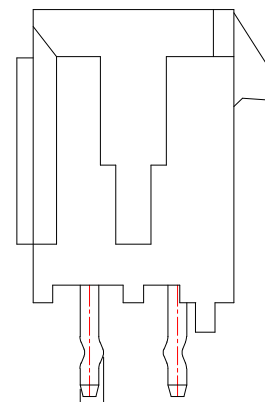

TYPE 2(打K脚)

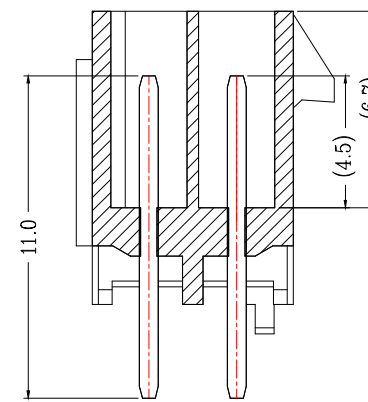
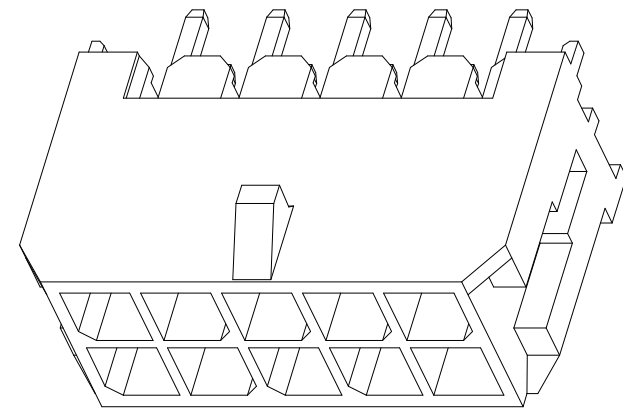

SECTION A-A

| CKT | A | B |
|------|------|-------|
| 2*1 | | 6.00 |
| 2*2 | 3.0 | 9.00 |
| 2*3 | 6.0 | 12.00 |
| 2*4 | 9.0 | 15.00 |
| 2*5 | 12.0 | 18.00 |
| 2*6 | 15.0 | 21.00 |
| 2*7 | 18.0 | 24.00 |
| 2*8 | 21.0 | 27.00 |
| 2*9 | 24.0 | 30.00 |
| 2*10 | 27.0 | 33.00 |
| 2*11 | 30.0 | 36.00 |
| 2*12 | 33.0 | 39.00 |

技术指标(Technical Index):

1. 温度范围(Temperature range): -25° C~+85° C.
2. 额定电压(Rated voltage): 600V, AC, DC.
3. 额定电流(Rated current): 5.0A AC, DC.
4. 接触电阻(Contact resistance): ≤20mΩ .
5. 耐压值(Withstanding voltage): 1500V AC/minute.
6. 绝缘电阻(Insulation resistance): ≥1000MΩ.

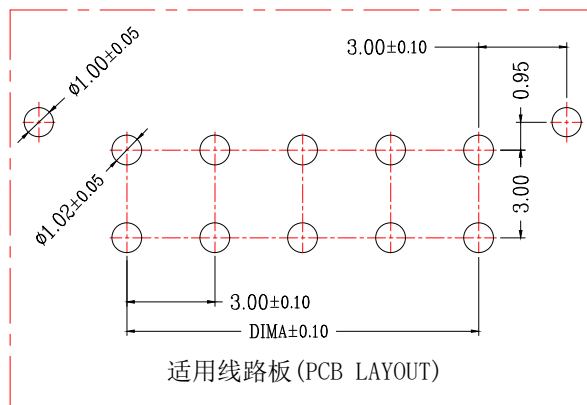

适用线路板(PCB LAYOUT)



一般公差(TOLERANCE)
 X: ±.50 XX: ±1.0
 .X: ±.20 .XXX: ±.05
 ANGLES: ±1°



| | | | |
|------------|-----------------|-----------|--------|
| 品名(TITLE) | MX3.0双排直针WTB | 制图(DR) | |
| 料号(DWG.NO) | BX-MX3.0-2-4PZZ | 校对(CHKD) | |
| 比例(SCALE) | 1:1 | 审核(APPD) | |
| 单位(UNITS) | mm | 张数(SHEET) | 1 OF 1 |
| | | SIZE | A4 |
| | | REV | A |