

SPECIFICATIONS

Current Rating: 3Amps
 Insulation Resistance: 1000MΩ Min
 Contact Resistance: 20mΩ Max
 Withstanding Voltage: AC 1000V
 Operation Temperature: -40° to +105°
 Contact Material: Brass
 Insulator Material: Polyester (UL 94V-0)
 Contact plating: Gold Flash
 Standard: PA6T
 Max. Processing Temp: 240° C for 30-60 seconds
 (260° C for 10 seconds)

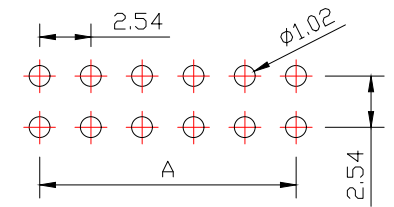

RECOMMEND P. C. B LAYOUT
 PCB TOLERANCE: ±0.05 (TOP VIEW)

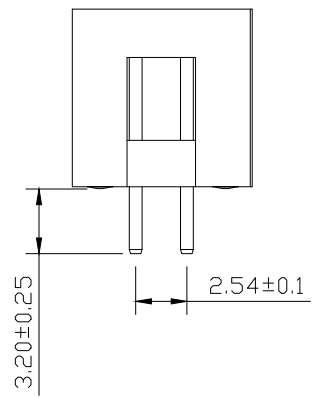
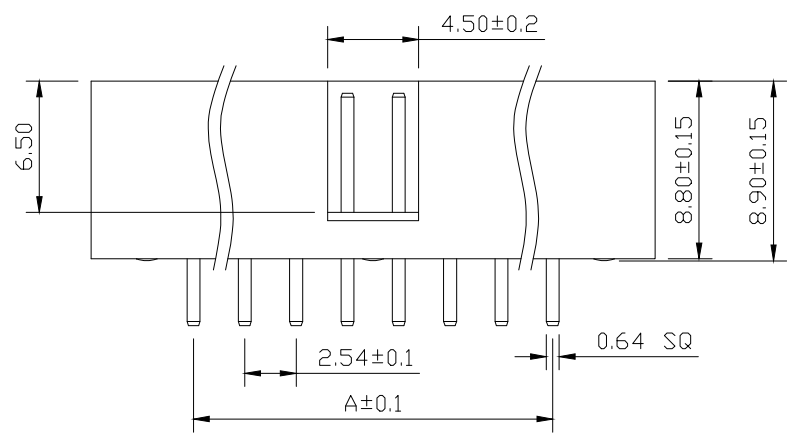
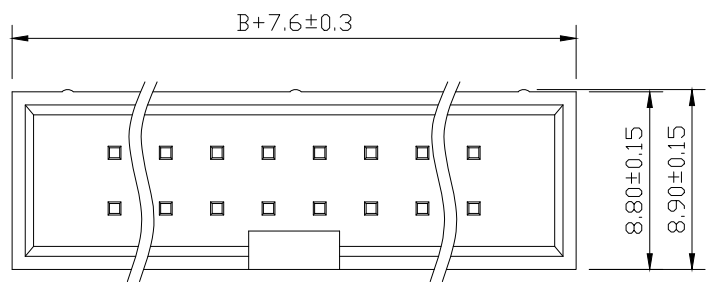

No. of	DIM. A	DIM. B	No. of	DIM. A	DIM. B	No. of	DIM. A	DIM. B
6	5.08	7.62	20	22.86	25.40	36	43.18	45.72
8	7.62	10.16	24	27.94	30.48	40	48.26	50.80
10	10.16	12.70	26	30.48	33.02	44	53.34	55.88
12	12.70	15.24	28	33.02	35.56	50	60.96	63.50
14	15.24	17.78	30	35.56	38.10	60	73.66	76.20
16	17.78	20.32	32	38.10	40.64	64	78.74	81.28
18	20.32	22.86	34	40.64	43.18			

UNLESS OTHERWISE SPECIFIED TOLERANCE
 X : ±0.30 X° : ±5°
 X.X : ±0.25 X.X° : ±1°
 X.XX : ±0.20 X.XX° : ±0.5°

DRAWN NAME: 2.54DC3-NPin H8.9 180度 PC3.2 L11.5 6T
 SIZE A4 SCALE N:1 PROUCT NO. BX-1DC2.54-2-5PZZ
 REV A UNIT mm PROJECT PAGE 1/1

CHECKED: / / CHECKED: / / APPROVED: / /

THESE DRAWINGS AND SPECIFICATIONS ARE THE PROPERTY OF SHENZHEN YIXINYING TECHNOLOGY CO., LTD AND SHALL NOT BE REPRODUCED, COPIED OR USED IN ANY MANNER WITHOUT THE PRIOR WRITTEN CONSENT OF SHENAHEN YIXINYING TECHNOLOGY CO., LTD