

标记 MARK.	更改内容 MODIFICATION	日期 DATE	修改 DRAW	核准 APPROVE

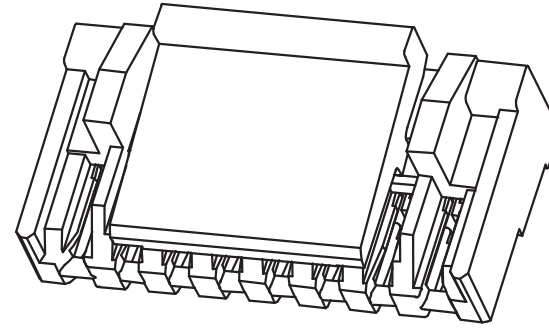
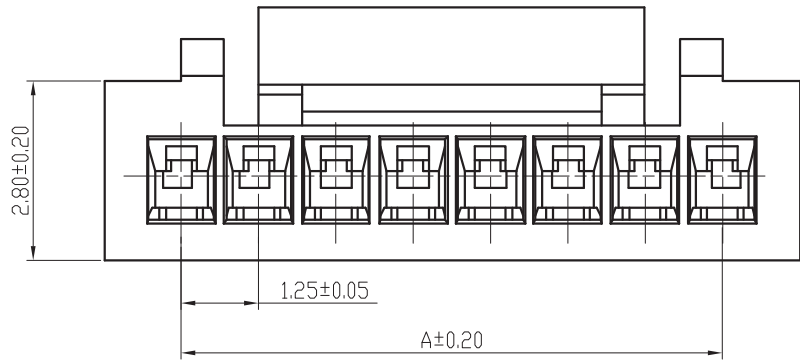

技术要求Specification:

- 1、材质Material: PA66 UL94V-0;
- 2、额定电流 Current rating:1.0A AC,DC
- 3、额定电压 Voltage rating: 50V AC,DC
- 4、温度范围 Temperature range:-25℃to+85℃
- 5、接触电阻 Contact resistance:≤30mΩ
- 6、绝缘电阻 Insulation resistance:≥100MΩ
- 7、耐压 Withstand voltage:500V AC/minute
- 8、塑件表面平整光洁, 无明显的毛刺、气泡、变形、浇口拉伤、缺料等不良现象。

Plastic surface smooth and clean, no obvious burrs, bubbles, distortion, gate strain, lack of material and other undesirable phenomena.

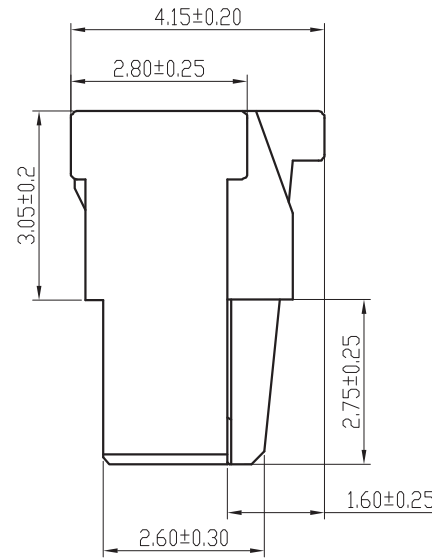
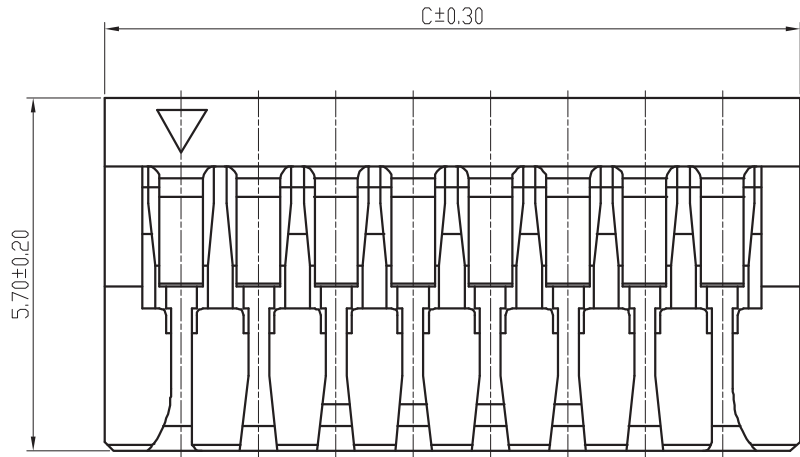

线数	型号	尺寸			
		A	B	C	D
2	SH12512-2Y	1.25	2.00	3.75	---
3	SH12512-3Y	2.50	3.20	5.00	---
4	SH12512-4Y	3.75	4.30	6.25	---
5	SH12512-5Y	5.00	4.30	7.50	6.25
6	SH12512-6Y	6.25	6.25	8.75	8.75
7	SH12512-7Y	7.50	6.25	10.00	8.75
8	SH12512-8Y	8.75	6.25	11.25	8.75
9	SH12512-9Y	10.00	6.25	12.50	8.75
10	SH12512-10Y	11.25	8.30	13.75	10.70
	SH12512-11Y	12.50	8.30	15.00	10.70
	SH12512-12Y	13.75	8.30	16.25	10.70
	SH12512-13Y	15.00	8.30	17.50	10.70
	SH12512-14Y	16.25	8.30	18.75	10.70
	SH12512-15Y	17.50	8.30	20.00	10.70
	SH12512-16Y	18.75	8.30	21.25	---

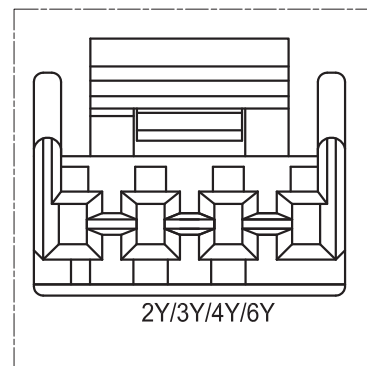
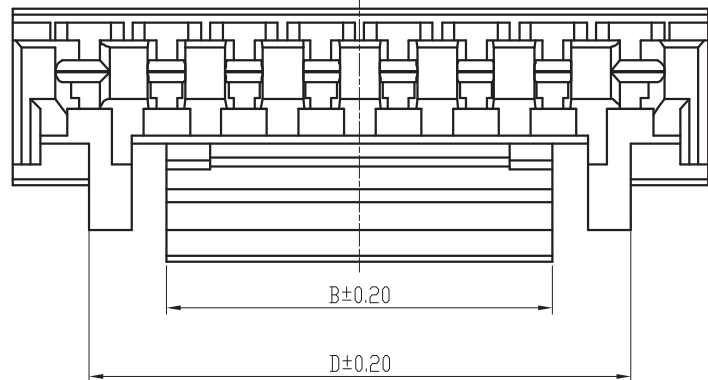

OTHERWISE SPECIFIED		☞: Inspection Item					
.X±0.30	X.° ±1°	☉:Cp/Cpk and SPC Control Item					
.XX±0.20	.X° ±	材料 MATERIAL	PA66	名称 TITLE	GH1.25胶壳-2Pin		
.XXX±0.10	.XX° ±	料厚 THICK		编号 DWG NO.	BX-GH1.25-2PJK	单位 UNIT	m m
制图 DRAWIN		料宽 WIDE		比例 SCALE	1:1	版本 R E V.	A
审核 CHECKED	Zhou qi	日期 DATE		角法 PROJ.			规格书
批准 APPROVE							