

REV.	DESCRIPTION	DATE
A/0	新版发行	2023/05/09

技术要求:

- 1、塑件材料: PA66 (UL-94V-0)
- 2、接触件: 黄铜镀锡
- 3、接触电阻: $\leq 20m\Omega$
- 4、绝缘电阻: $\geq 1000M\Omega$
- 5、额定电压: 250V AC DC
- 6、额定电流: 3.0A AC DC
- 7、耐压: 能承受1000V AC/Minute
- 8、工作温度: $-25^{\circ} \sim +105^{\circ}$
- 9、可焊性试验: 浸锡面积 $\geq 95\%$ 温度 235^{+5}_{-0} , 时间 2.5 ± 0.5 秒
- 10、铅和镉等六大有害物质含量要符合环保要求

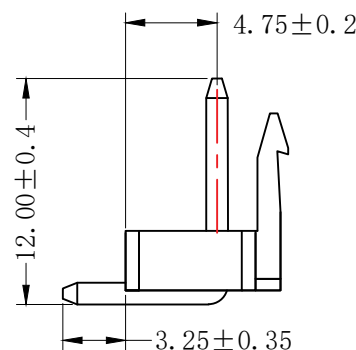
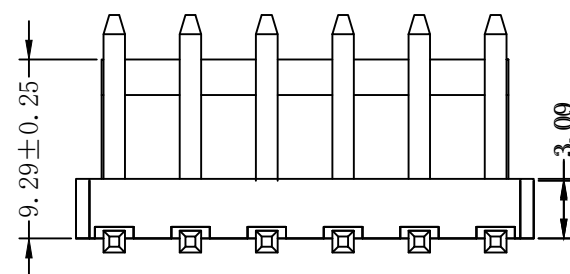
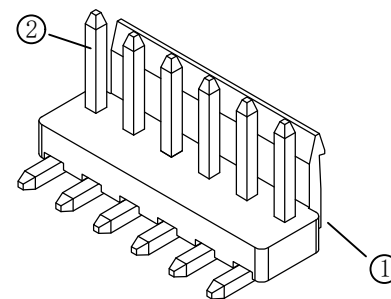
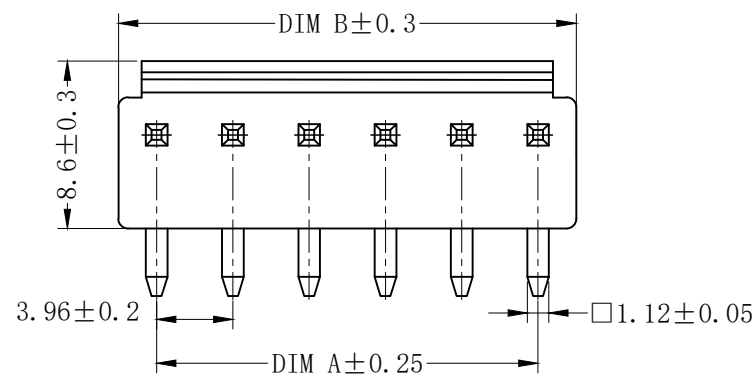

Circuits	Dimensions (mm)	
	A	B
02	3.96	7.92
03	7.92	11.88
04	11.88	15.84
05	15.84	19.80
06	19.80	23.76
07	23.76	27.72
08	27.72	31.68
09	31.68	35.64
10	35.64	39.60
11	39.60	43.56
12	43.56	47.52
13	47.52	51.48
...
20	75.24	79.20

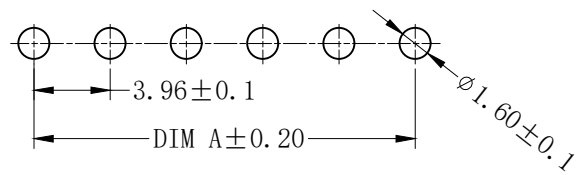

SUGGESTED PCB LAYOUT
(COMPONENT SIDE)

序号	名称	材料	数量	附注
2	端子 Contact	黄铜	n x 1	电镀层: 整个表面镀锡 30u"MIN, 厚度 80u"MIN.
1	基板 Wafer	PA66 (UL94V-0)	1	白色

GENERAL TOLERANCES			DRAWN BY	Bossie (博锡)
0.X	±0.25	X.° ±3°	CHK. BY	
0.XX	±0.12		APRV. BY	
0.XXX	±0.05	X.X° ±0.5°	DRAWING NO.	SHEET
UNIT	SIZE	SCALE	1 OF 1	PROD. NAME VH 3.96 弯针 2 P
MM	A4	1:1	TITLE	PART NO. BX-VH3.96-2PWZ

借用登记
旧底图总号
底图总号
签字
日期