

Features

- Low power loss
- Ultra-fast recovery time for high efficiency
- Glass passivated chip junction
- Low leakage current
- High forward surge capability
- Meets MSL level 1, per J-STD-020,LF maximum peak of 260 °C

Typical Application

For use in high frequency rectification and freewheeling application in switching mode converters and inverters for consumer ,computer and telecommunication.

Mechanical Data

- Package: DO-214AC (SMA)
Molding compound meets UL 94 V-0 flammability rating,RoHS-compliant
- Terminals: Tin plated leads, solderable per J-STD-002 and JESD22-B102
- Polarity: Color band denotes cathode end

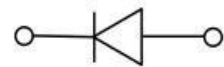

Maximum Ratings (Ta=25°C Unless otherwise specified)

PARAMETER	Symbol	Unit	Conditions	MUR120SA
Repetitive Peak Reverse Voltage	V_{RRM}	V		200
Average Forward Current	$I_{F(AV)}$	A	Ta=25°C	1.0
Surge(Non-repetitive)Forward Current	I_{FSM}	A	Ta=25°C 60Hz Half-sine wave,1 cycle, Ta=25°C	30
Storage Temperature	T_{stg}	°C		-55 ~ +150
Junction Temperature	T_j	°C		-55 ~ +150

Electrical Characteristics (Ta=25°C Unless otherwise specified)

PARAMETER	Symbol	Unit	Condition	MUR120SA	
Peak Forward Voltage	V_{FM}	V	IF=1.0A	0.9	
Peak Reverse Current	I_{RRM1}	μA	$V_{RM}=V_{RRM}$	Ta=25°C	5.0
	I_{RRM2}			Ta=125°C	300
Reverse Recovery time	T_{rr}	ns	IF =0.5A R =1A RR =0.25A	25	
Thermal Resistance(Typical)	$R_{θJ-L}$	°C/W	Between junction and ambient	24	
Typical junction capacitance	C_j	pF	Measured at 1MHZ and Applied Reverse Voltage of 4.0 V.D.C	25	
Non repetitive reverse avalanche energy	ER	mJ	I(BR)R = 0.7 A, inductive load	10	

Characteristics (Typical)

FIG1: Forward Current Derating Curve

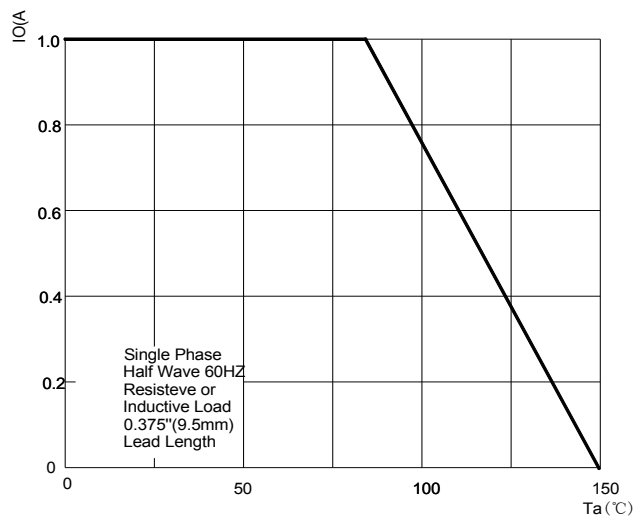

FIG2: Surge Forward Current Capability

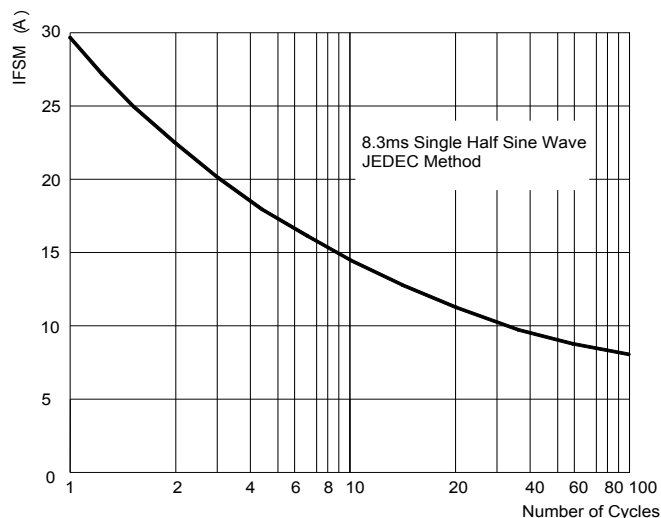

FIG3: Instantaneous Forward Voltage

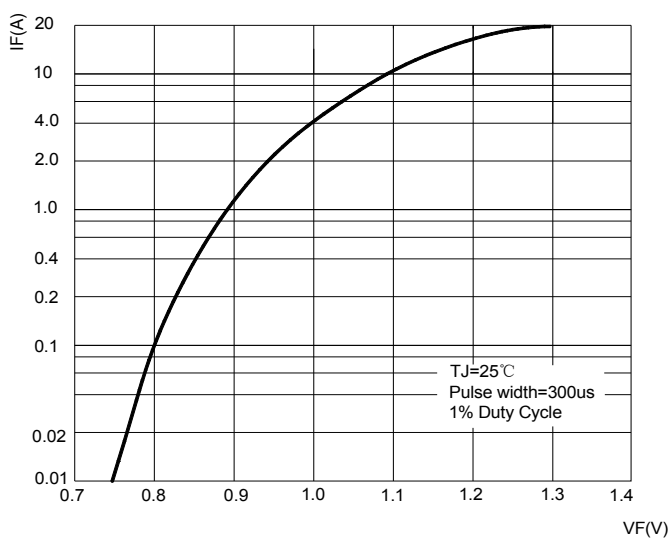

FIG4: Typical Reverse Characteristics

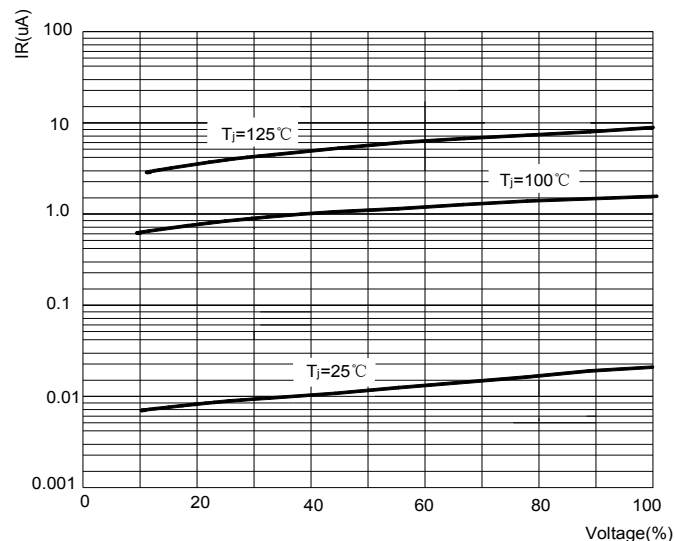
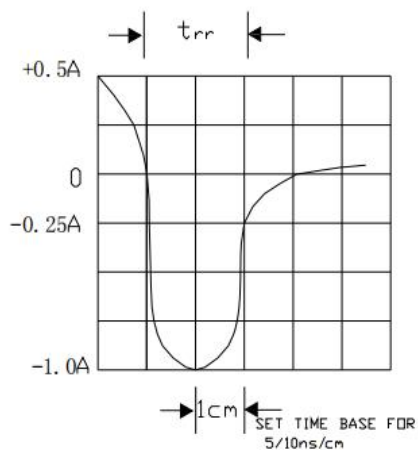
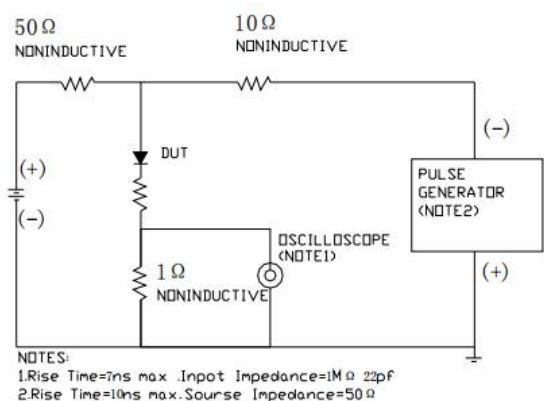

FIG5: Diagram of circuit and Testing wave form of reverse recovery time



Ordering Information (Example)

PREFERED	PACKAGE CODE	MINIMUM PACKAGE(pcs)	INNER BOX QUANTITY(pcs)	OUTER CARTON QUANTITY(pcs)	DELIVERY MODE
MUR120SA	DO-214AC(SMA)	5000	10000	80000	13" reel
MUR120SA	DO-214AC(SMA)	7500	15000	120000	13" reel

Outline Dimensions

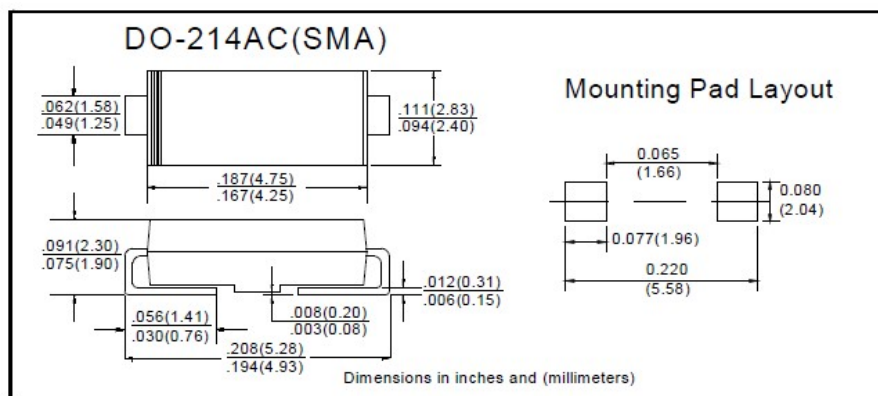

IMPORTANT NOTICE AND DISCLAIMER

AM RESERVES THE RIGHT TO MAKE CHANGES TO ALL PRODUCT, PRODUCT SPECIFICATIONS AND DATA WITHOUT NOTICE TO IMPROVE RELIABILITY, FUNCTION OR DESIGN OR OTHERWISE. CUSTOMERS SHOULD OBTAIN AND CONFIRM THE LATEST PRODUCT INFORMATION AND SPECIFICATIONS BEFORE FINAL DESIGN PURCHASE OR USE.

AM disclaim any and all liability for any errors, inaccuracies or incompleteness contained in any datasheet or in any other disclosure relating to any product.

All information are provided as-is, even it has qualified by the AEC-Q101 which satisfy industrial application requirement, except as expressly stated in this data sheet is applied for automotive grade, AM make no warranties, representation or guarantee, whether express, implied or statutory, including, without limitation, regarding any merchantability, satisfactory quality, or fitness for a particular purpose with respect to AM.

Am does not assume any liability or compensation for any application assistance or customer product design, and make no warranty or accept any liability with products, which are purchased or used for any unintended or unauthorized application.

Except as expressly indicated in writing, AM products are not designed for use in medical, life-saving, or lifesustaining applications or for any other application in which the failure of the AM product could result in personal injury or death. Customers using or selling AM products not expressly indicated for use in such applications do so at their own risk. Please contact authorized AM personnel to obtain written terms and conditions regarding products designed for such applications.

No license, express or implied, by estoppel or otherwise, to any intellectual property rights is granted by this document or by any conduct of AM. Product names and markings noted herein may be trademarks of their respective owners.