

SS12F THRU SS120F

VOLTAGE RANGE 20 to 200 Volts
CURRENT 1.0 Ampere

Features

SMAF



- The plastic package carries Underwriters Laboratory Flammability Classification 94V-0
- For surface mounted applications
- Metal silicon junction, majority carrier conduction
- Low power loss, high efficiency
- Built-in strain relief, ideal for automated placement
- High forward surge current capability
- High temperature soldering guaranteed: 260 C/10 seconds at terminals



Mechanical Data

- Case: Transfer molded plastic
- Epoxy: UL 94V-0 rate flame retardant
- Lead :Solder plated, solderable per MIL-STD-750 method 2026
- Polarity: Color band denotes cathode end
- Weight: 0.00095ounce, 0.028grams

Maximum Ratings and Electrical Characteristics

- Ratings at 25°C ambient temperature unless otherwise specified
- Single phase, half wave, 60Hz, resistive or inductive load
- For capacitive load derate current by 20%

TYPE NUMBER	SYMBOL S	SS 12F	SS 14F	SS 15F	SS 16F	SS 18F	SS 110F	SS 115F	SS 120F	UNIT	
Maximum Repetitive Peak Reverse Voltage	V _{RRM}	20	40	50	60	80	100	150	200	Volts	
Maximum RMS Voltage	V _{RMS}	14	28	35	42	56	70	105	140	Volts	
Maximum DC Blocking Voltage	V _{DC}	20	40	50	60	80	100	150	200	Volts	
Maximum Average Forward Rectified Current at T _L see figure 1 T _L = 100°C	I _(AV)	1.0								Amps	
Peak Forward Surge Current 8.3ms single half sine-wave superimposed on rated load (JEDEC method)	I _{FSM}	30								Amps	
Maximum Instantaneous Forward Voltage @ 1.0A(Note1)	V _F	0.55	0.70	0.85	0.90					Volts	
Maximum DC Reverse Current at rated DC Blocking Voltage per element	T _A = 25°C	0.1							0.01	mA	
	T _A = 100°C	20.0				10.0		2.0			
Typical Thermal Resistance (Note 2)	R _{θJA}	80								°C/W	
	R _{θJL}	32									
Diode junction capacitance (Note 3)	C _J	260	150							pF	
Operating Junction Temperature	T _J	(-55 to +150)							(-65 to +175)		°C
Storage Temperature Range	T _{STG}	(-55 to +150)									°C

Notes:

1. Pulse test: 300µs pulse width, 1% duty cycle.
2. Unit mounted on P.C.B. with 0.20"×0.20"(5.00mm×5.00mm) copper pads.
3. f=1MHz and applied 4V DC reverse voltage.

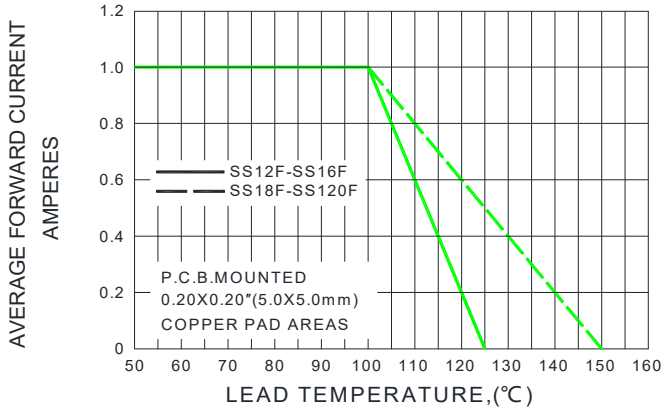
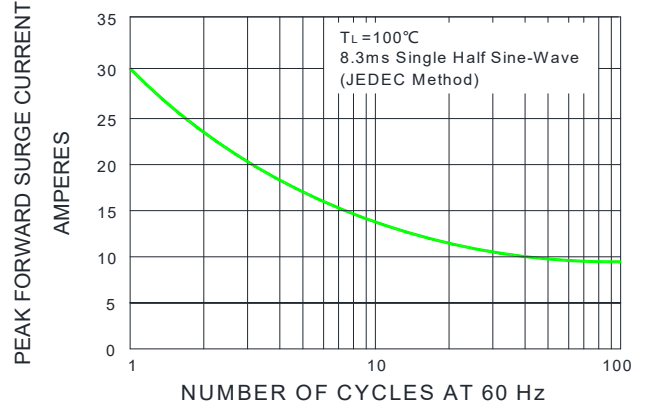
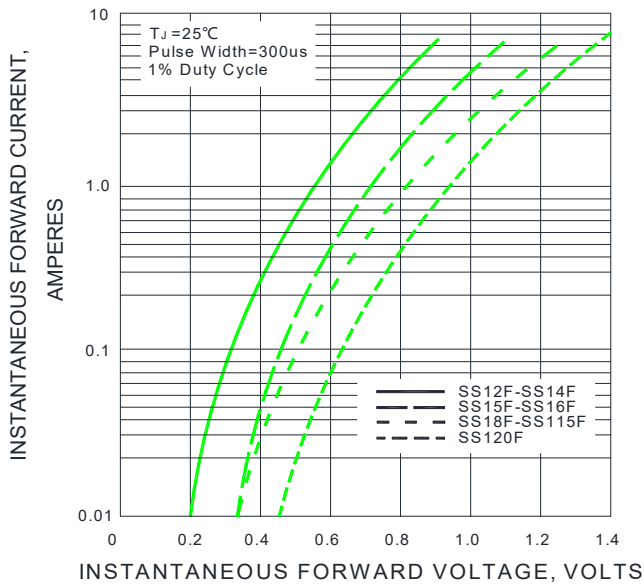
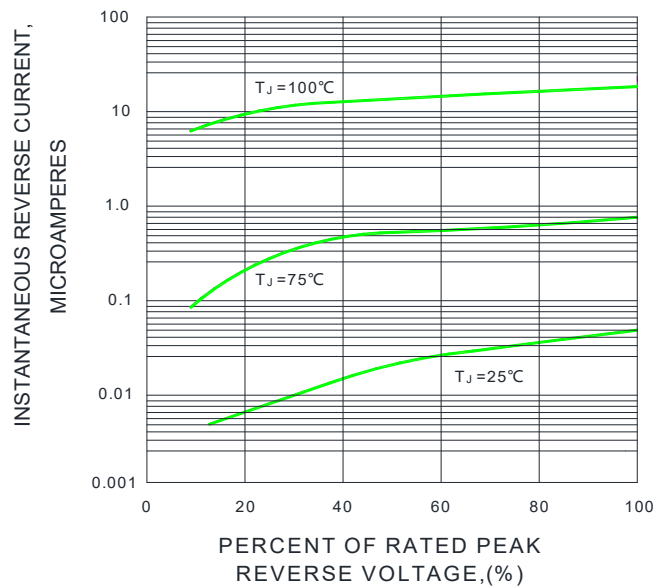
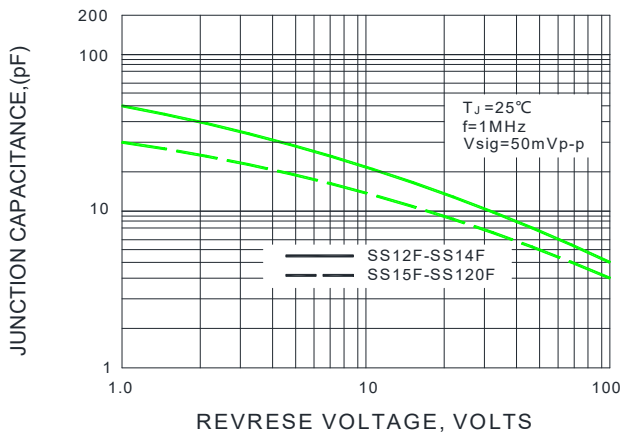
SS12F THRU SS120F
VOLTAGE RANGE 20 to 200 Volts
CURRENT 1.0 Ampere
Ratings and Characteristic Curves (TA=25°C unless otherwise noted)
FIG.1-FORWARD CURRENT DERATING CURVE

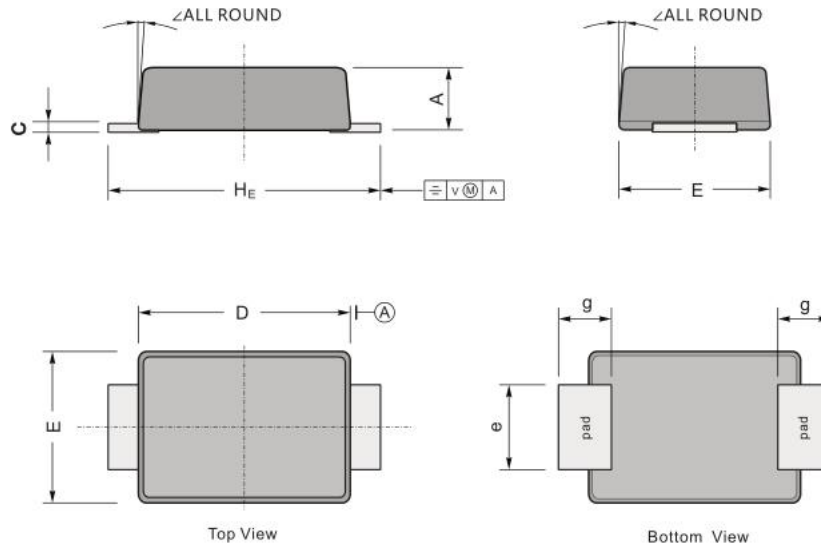
FIG.2-MAXIMUM NON-REPETITIVE PEAK FORWARD SURGE CURRENT

FIG.3-TYPICAL INSTANTANEOUS FORWARD CHARACTERISTICS

FIG.4-TYPICAL REVERSE CHARACTERISTICS

FIG.5-TYPICAL JUNCTION CAPACITANCE

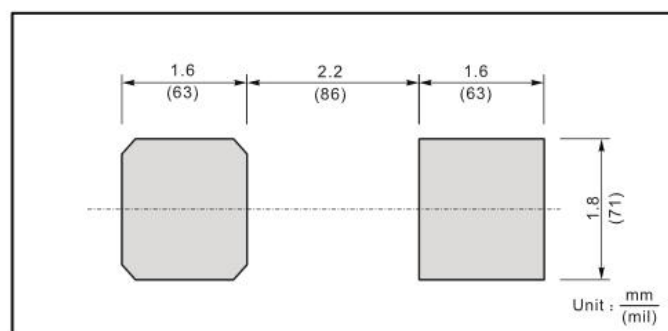
Package Outline Dimensions in inches (millimeters)

UNIT		A	C	D	E	e	g	H _E	∠
mm	max	1.10	0.20	3.70	2.70	1.60	1.20	4.90	5-7°
	min	0.90	0.12	3.30	2.40	1.30	0.80	4.40	
mil	max	43	7.90	146	106	63	47	193	
	min	35	4.70	130	94	51	31	173	

The Recommended Mounting Pad Size
Marking

Type number	Marking code
SS12F	SS12F
SS14F	SS14F
SS15F	SS15F
SS16F	SS16F
SS18F	SS18F
SS110F	SS110F
SS115F	SS115F
SS120F	SS120F

The recommended mounting pad size

Packing Requirments

- PS black anti-static carrier tape packing

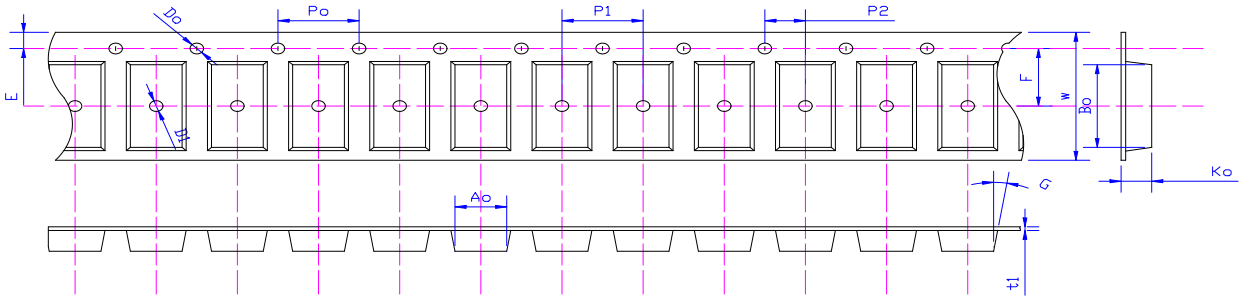

Specifications	A_o	B_o	K_o	P_o	W	t_1
SMAFL	2.83 ± 0.10	4.90 ± 0.10	1.45 ± 0.10	4.00 ± 0.1	12.0 ± 0.05	0.23 ± 0.02

- 13" antistatic plastic reel

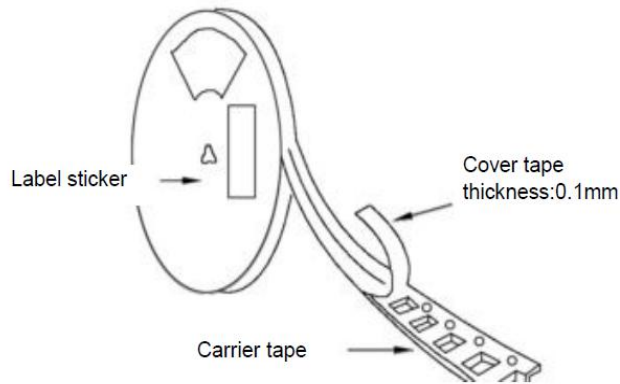

DEVICE TYPE	13" Reel			
	Q'TY/REEL(pcs)	REEL/BOX	BOX/CARTOON	Q'TY/CARTON(pcs)
SMAFL	10000	2	8	160000

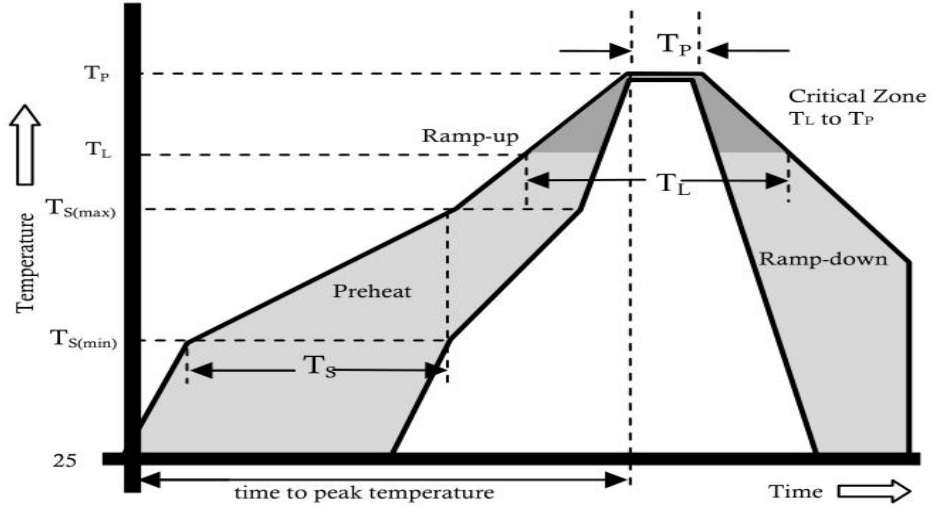
Reflow Profile

Reflow Condition		Pb-Free Assembly
Pre Heat	Temperature Min.	+150°C
	Temperature Max.	+200°C
	Time(Min to Max)	60-180 secs.
Average ramp up rate(Liquidus Temp(T_L) to peak)		3°C/sec. Max.
$T_{S(max)}$ to T_L - Ramp-up Rate		3°C/sec. Max.
Reflow	Temperature (T_L)(Liquidus)	+217°C
	Temperature (T_L)	60-150 secs.
Peak Temp (T_P)		+(260±0/-5) °C
Time within 5°C of actual Peak Temp (T_P)		25 secs.
Ramp-down Rate		6°C/sec. Max.
Time 25°C to peak Temp (T_P)		8 min. Max.
Do not exceed		+260°C