

**SEE PAGE 2 FOR DETAILS

WIRING SCHEMATIC

1	2
PIN	PIN
1 = BROWN	1 = RED
2 = WHITE	2 = GREEN
3 = BLUE	3 = BLACK
4 = BLACK	4 = WHITE
5 = GREY	5 = GREY

FPM12A05IYYDF0Y
 INCHES ————
 01 = WIRING SCHEMATIC 1
 02 = WIRING SCHEMATIC 2
 LENGTH
 EX: 06 = 6 INCHES
 12 = 12 INCHES

NOTE: PACKAGED 10 PER BAG

RoHS COMPLIANT

UNITS IN INCHES [MM] DO NOT SCALE FROM DRAWING



THESE DRAWINGS AND SPECIFICATIONS ARE THE PROPERTY OF NorComp AND SHALL NOT BE REPRODUCED, COPIED OR USED AS THE BASIS FOR THE MANUFACTURE OR SALE OF APPARATUS WITHOUT WRITTEN PERMISSION.

DRAWN:
G. BROWN
 DATE:
 01/23/2019

NorComp

SCALE: NTS	SHEET 1	OF 2	REV 4
DWG NO.		FPM12A05IYYDF0Y	

DESCRIPTION: M12 5 POSITION STAINLESS STEEL FEMALE PIGTAIL

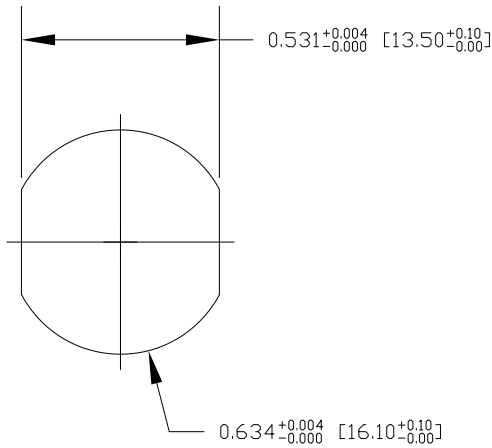

RECOMMENDED PANEL CUT-OUT

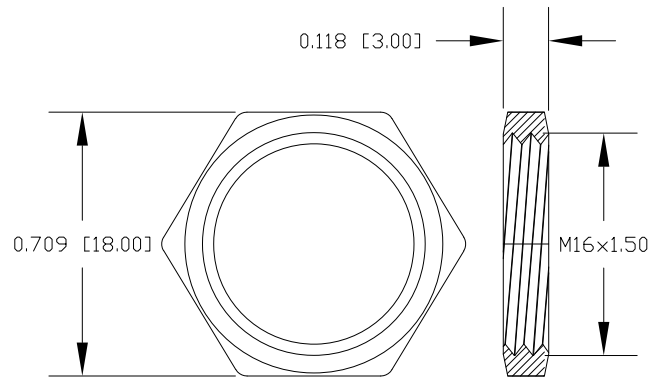

NUT

NOTE:

MATERIAL	
HOUSING:	PBT UL94V-0, BLACK
CONTACT:	BRASS
NUT:	STAINLESS STEEL 316
SHELL:	STAINLESS STEEL 316
O-RING:	EPDM, BLACK
FINISH	
CONTACT:	GOLD PLATED 10μ" Min.
UNDER PLATE:	NICKEL
ELECTRICAL	
RATED CURRENT:	4A
RATED VOLTAGE:	60V
INSULATION RESISTANCE:	100MΩ MIN
CONTACT RESISTANCE:	10mΩ MAX
WATER PROOF:	IP67/68
ENVIRONMENT	
OPERATION TEMPERATURE:	-40°C ~ +85°C

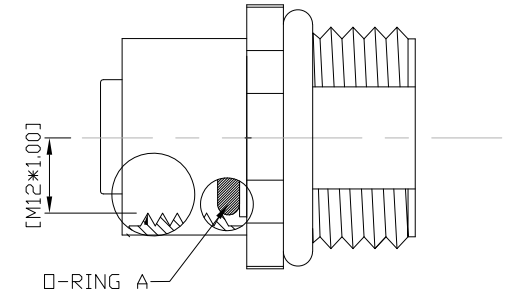
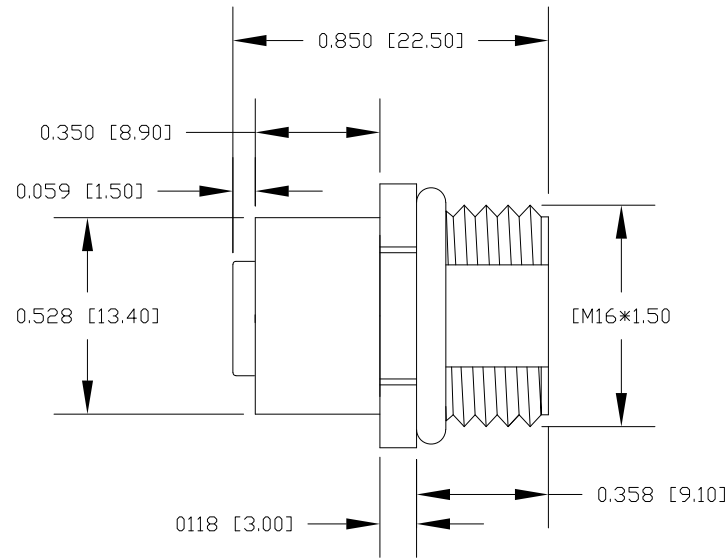
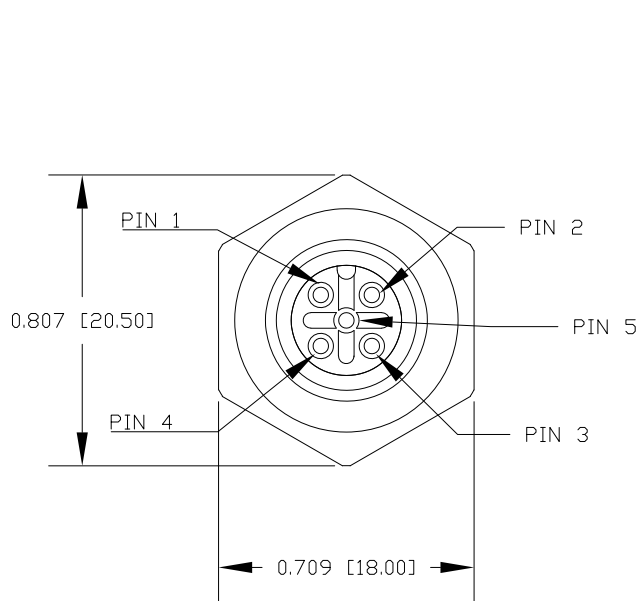

RoHS COMPLIANT

UNITS IN INCHES [MM] DO NOT SCALE FROM DRAWING



THESE DRAWINGS AND SPECIFICATIONS ARE THE PROPERTY OF NorComp AND SHALL NOT BE REPRODUCED, COPIED OR USED AS THE BASIS FOR THE MANUFACTURE OR SALE OF APPARATUS WITHOUT WRITTEN PERMISSION.

DRAWN:
G. BROWN
DATE:
01/23/2019

NorComp

SCALE: NTS	SHEET 2	OF 2	REV 4
DWG NO.		FPM12A05IYYDF0Y	