

**■ Features**

- Molding Inductor.
- High reliability.
- High current, low DCR, high efficiency.
- Very low acoustic noise and very low leakage flux noise.
- Operating temperature:  $-55^{\circ}\text{C} \sim +125^{\circ}\text{C}$  (Including self-temperature rise) .

**■ Applications**

- General Electronic.
- Video Device, TV, TFT.
- Power Module for PC.
- NB/Lap Top Computer.
- Server, VGA Card/Module.
- DC/DC converter.

**■ Product Identification**



(1) : Type

(2) : Dimensions

(3) : Inductance value

(4) : Inductance Tolerance : N= $\pm 30\%$ , M= $\pm 20\%$

**■ Shapes and Dimensions (Unit: mm)**

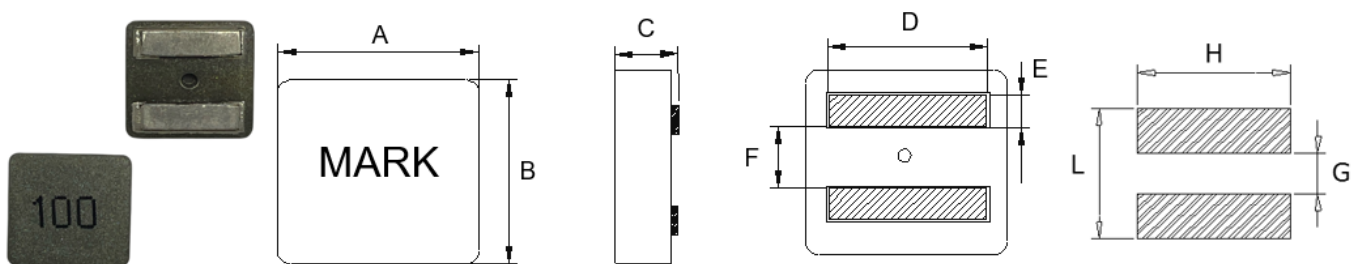

TYPE	A	B	C	D	E	F	G Ref.	H Ref.	L Ref.
YSPIT1510A	16.5 $\pm$ 0.3	15.5 $\pm$ 0.3	9.7 $\pm$ 0.3	13.2 $\pm$ 0.5	3.2 $\pm$ 0.3	7.0 $\pm$ 0.3	6.0	15.0	15.0

### ■ YSPIT1510A Series

Part Number	Inductance (uH) @100KHz/0.1V	DCR Max. (mΩ)	Saturation Current (A)		Heat Rating Current Typ.(A)	
			Max.	Typ.	20°C rise	40°C rise
YSPIT1510A-4R7M	4.7±20%	3.8	39.0	43.0	22.0	30.0
YSPIT1510A-5R6M	5.6±20%	4.2	34.0	38.0	21.0	28.0
YSPIT1510A-6R8M	6.8±20%	4.6	31.0	36.0	20.0	26.0
YSPIT1510A-8R2M	8.2±20%	7.2	28.0	32.0	19.0	25.0
YSPIT1510A-100M	10±20%	8.6	26.0	29.0	18.0	24.0
YSPIT1510A-150M	15±20%	11.5	18.0	20.0	14.0	18.0
YSPIT1510A-220M	22±20%	15.8	16.0	18.0	10.5	14.2
YSPIT1510A-330M	33±20%	20.0	14.0	16.7	8.6	12.3

- ※ The saturation current value is the DC current value having inductance decrease down to 30%.(at 25°C)
- ※ The temperature rise current value is the DC current value having temperature increase up to 40°C. (at 25°C)
- ※ The rated current is the DC current value that satisfies both of current value saturation current value and temperature rise current value.

## ■ Mechanical Reliability

Item	Specification and Requirement	Test Method
Solderability	1. No case deformation or change in visual 2. New solder coverage More than 95%	1. Preheat : 155°C±5°C , 60S±2S 2. Tin: lead-free. 3. Temperature: 240°C±5°C , flux 3.0S±0.5S.
Mechanical shock	1. No case deformation or change in visual 2. $\Delta L/L_0 \leq \pm 10\%$	1. Acceleration : 100G 2. Pulse time: : 6ms 3. 3 times in each positive and negative direction of 3 mutual perpendicular directions
Mechanical vibration	1. No case deformation or change in visual 2. $\Delta L/L_0 \leq \pm 10\%$	1. Reflow: 2times 2. Frequency: 10HZ ~ 50HZ ~ 10HZ, 20 Min/Cycles 3. Amplitude: 1.52 mm±10% 4. Directions: X,Y,Z 5. Time: 12 cycle / direction

## ■ Endurance Reliability

Item	Specification and Requirement	Test Method
Thermal Shock	Inductance change: Within $\pm 10\%$ Without distinct damage in visual	1. First -55°C for 30 minutes, last 125°C for 30 minutes as 1 cycle. Go through 1000 cycles. 2. Max transfer time is 3 minutes. 3. Measured at room temperature after placing for 24±2 hours
Biased Humidity	Inductance change: Within $\pm 10\%$ Without distinct damage in visual	1. Reflow 2 times, 2. 85°C±3°C, 85%±3%RH, 1000 hours 3. Measured at room temperature after placing for 24±2 hours
Low temperature storage	Inductance change: Within $\pm 10\%$ Without distinct damage in visual	1. Temperature : -55 ± 2°C 2. Time : 1000 hours 3. Measured at room temperature after placing for 24±2 hours
High temperature storage	Inductance change: Within $\pm 10\%$ Without distinct damage in visual	1. Temperature : +125 ± 2°C 2. Time : 1000 hours 3. Measured at room temperature after placing for 24±2 hours

**Recommended Soldering Technologies**

**Re-flowing Profile**

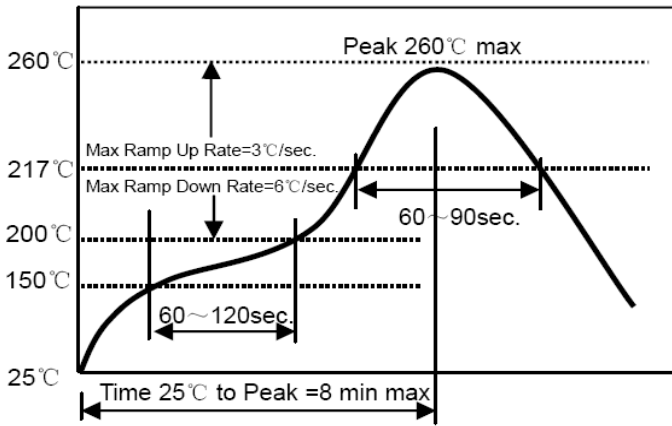

Preheat condition: 150 ~200°C/60~120sec.  
 Allowed time above 217°C: 60~90sec.  
 Peak temp: 260°C  
 Max time at Peak temp: 10 sec.  
 Solder paste: Sn/3.0Ag/0.5Cu  
 Allowed Reflow time: 2x max

**Iron Soldering Profile**

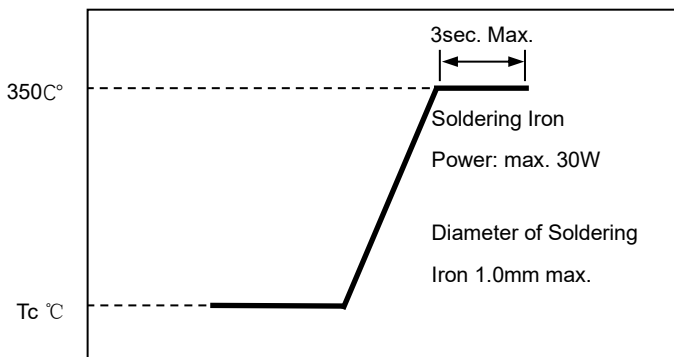

Iron soldering power: Max. 30W  
 Pre-heating: 150°C/60sec.  
 Soldering Tip temperature: 350°C Max.  
 Soldering time: 3sec. Max.  
 Solder paste: Sn/3.0Ag/0.5Cu  
 Max.1 times for iron soldering

**■ Taping Dimensions(Unit:mm)**

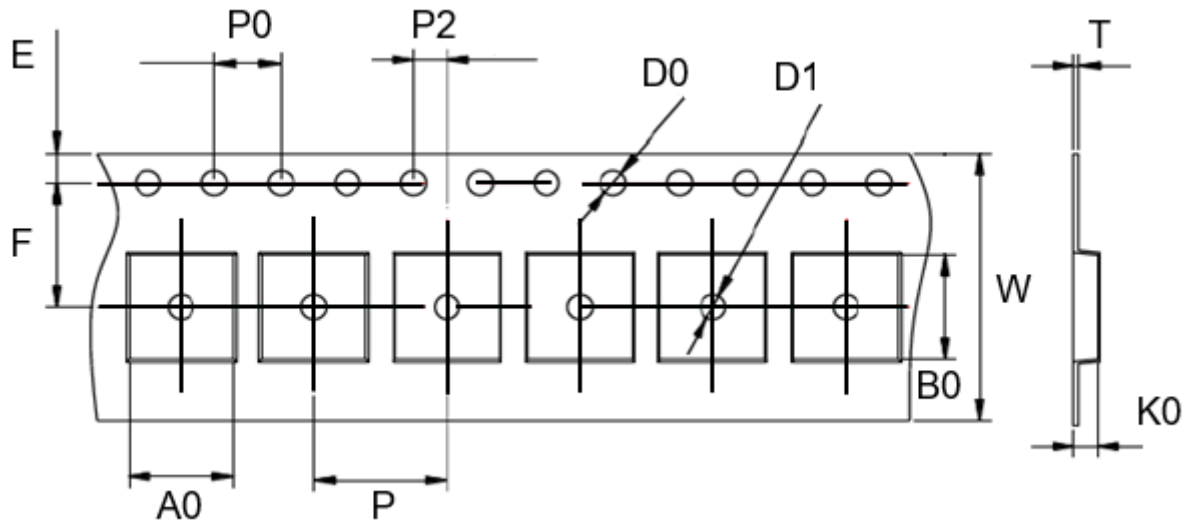

TYPE	W	P	P0	P2	D0	D1	T	A0	B0	K0	E	F	MPQ
YSPIT1510A	32.0 ±0.3	24.0 ±0.1	4.0 ±0.1	2.0 ±0.1	1.5 ±0.1	1.5 ±0.1	0.5 ±0.05	17.0 ±0.1	16.0 ±0.1	10.5 ±0.1	1.75 ±0.1	14.2 ±0.1	150

**■ Reel Dimensions(Unit:mm)**

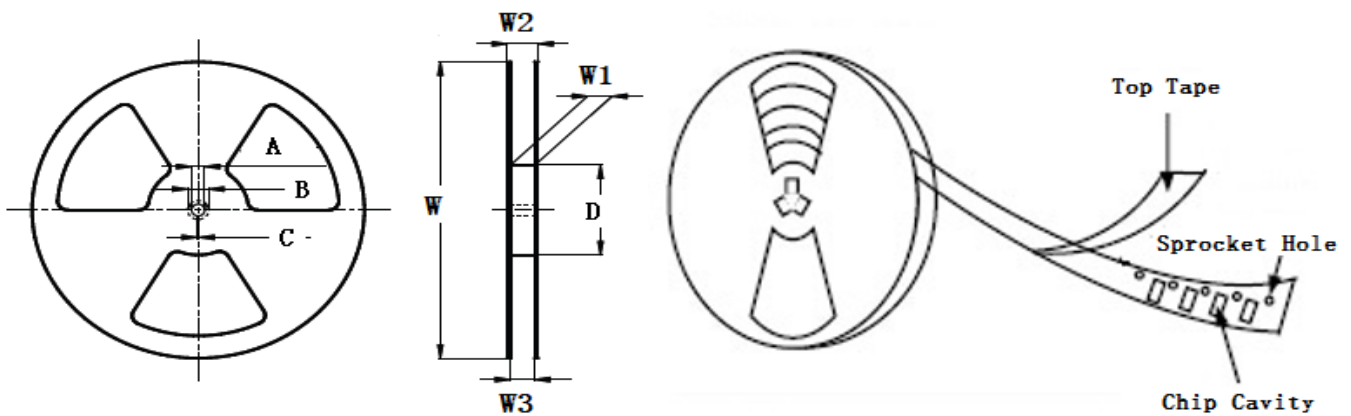

TYPE	W	W1	W2	W3	A	B	C	D
YSPIT1510A	330±2.0	32.4±2.0	38.4MAX	31.9 Min	13.0±0.5	21.0±0.8	2.0±0.5	97±0.5

**Direction of rolling**

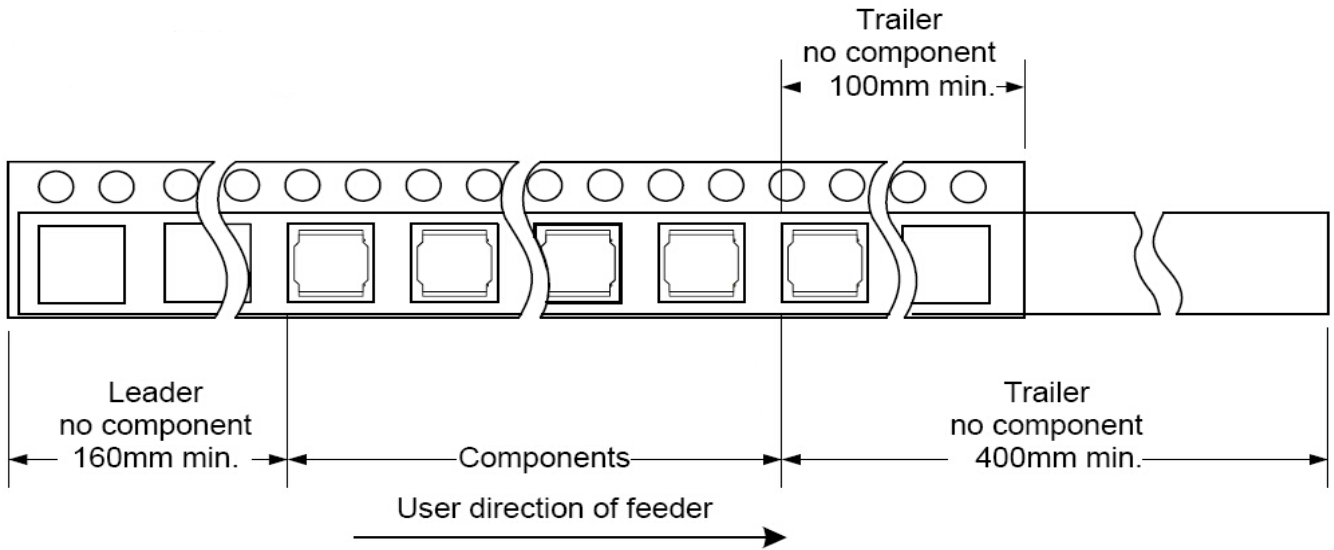

**Cover tape peel off condition**

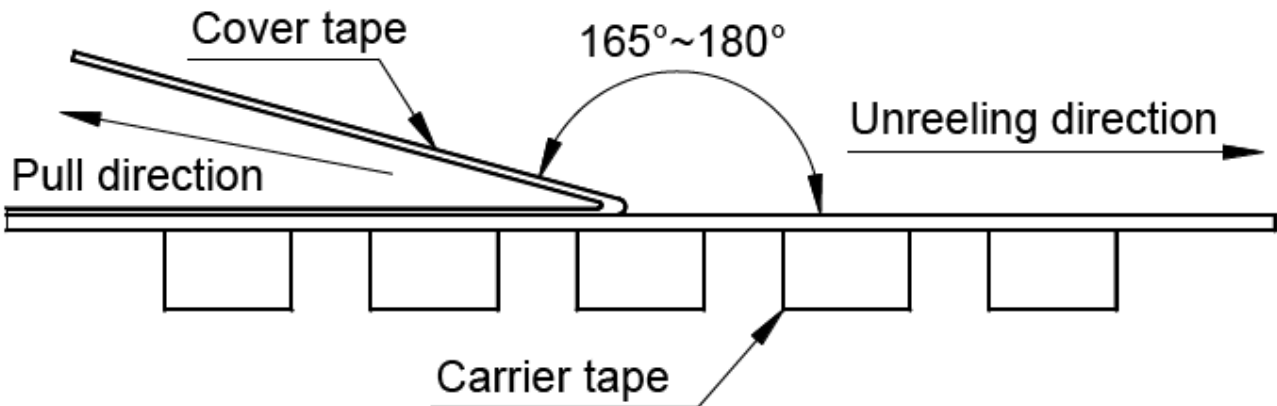

Cover tape peel force shall be 0.1N to 1.3N.

Reference peel speed 300±10mm/min.