

SAC-5P-M12MS/ 2,0-PUR/M12FS BK - Sensor/actuator cable



1544235

<https://www.phoenixcontact.com/us/products/1544235>

Please be informed that the data shown in this PDF document is generated from our online catalog. Please find the complete data in the user documentation. Our general terms of use for downloads are valid.



Sensor/actuator cable, 5-position, Plug straight M12, coding: A, on Socket straight M12, coding: A, cable length: 2 m

Commercial data

Item number	1544235
Packing unit	1 pc
Minimum order quantity	50 pc
Note	Made to order (non-returnable)
Sales key	BF03
Product key	BF1CDA
GTIN	4046356111829
Weight per piece (including packing)	92.3 g
Weight per piece (excluding packing)	92.3 g
Customs tariff number	85444290
Country of origin	PL

SAC-5P-M12MS/ 2,0-PUR/M12FS BK - Sensor/actuator cable



1544235

<https://www.phoenixcontact.com/us/products/1544235>

Technical data

Product properties

Product type	Sensor/actuator cable
Number of positions	5
No. of cable outlets	1
Shielded	no
Coding	A

Insulation characteristics

Overvoltage category	II
Degree of pollution	3

Material specifications

Flammability rating according to UL 94	HB
Seal material	NBR
Material of grip body	TPU, hardly inflammable, self-extinguishing
Contact material	CuSn
Contact surface material	Ni/Au
Contact carrier material	TPU GF
Material for screw connection	Zinc die-cast, nickel-plated

Electrical properties

Contact resistance	$\leq 5 \text{ m}\Omega$
Insulation resistance	$\geq 100 \text{ M}\Omega$
Nominal voltage U_N	48 V AC
	60 V DC
Nominal current I_N	4 A

Mechanical properties

Mechanical data

Insertion/withdrawal cycles	≥ 100
-----------------------------	------------

Signaling

Status display	No
Status display present	No

Connector

Connection 1

Type	Plug straight M12
Number of positions	5
Coding type	A
Number of positions	5

SAC-5P-M12MS/ 2,0-PUR/M12FS BK - Sensor/actuator cable



1544235

<https://www.phoenixcontact.com/us/products/1544235>

Connection 2

Type	Socket straight M12
Number of positions	5
Coding type	A
Number of positions	5

Cable/line

Cable length	2 m
--------------	-----

PUR halogen-free black [PUR]

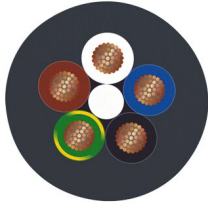
Dimensional drawing	
Cable weight	33 kg/km
UL AWM Style	20549
Number of positions	5
Shielded	no
Cable type	PUR halogen-free black [PUR]
Conductor structure signal line	42x 0.10 mm
AWG signal line	22
Conductor cross section	5x 0.34 mm ² (Signal line)
Wire diameter incl. insulation	1.27 mm 0.05 mm (Signal line)
External cable diameter	4.55 mm ±0.15 mm
Outer sheath, material	PUR
External sheath, color	black-gray RAL 7021
Conductor material	Bare Cu litz wires
Material wire insulation	PP
Single wire, color	brown, white, blue, black, green-yellow
Thickness, insulation	approx. 0.5 mm
Max. conductor resistance	max. 58 Ω/km (at 20 °C)
Insulation resistance	≥ 16 GΩ*km (at 20 °C)
Nominal voltage, cable	300 V
Test voltage	3000 V
Smallest bending radius, fixed installation	23 mm
Smallest bending radius, movable installation	46 mm
Max. bending cycles	4000000
Halogen-free	in accordance with DIN VDE 0472 part 815
Flame resistance	in accordance with UL 758/1581 FT2 DIN EN 60332-2-2 (20 s)

SAC-5P-M12MS/ 2,0-PUR/M12FS BK - Sensor/actuator cable



1544235

<https://www.phoenixcontact.com/us/products/1544235>

Resistance to oil	in accordance with DIN EN 60811-2-1
Other resistance	Highly resistant to acids, alkaline solutions and solvents
	hydrolysis and microbe resistant
	Resistant to salt water
	partly UV-resistant in accordance with DIN EN ISO 4892-2-A
Special properties	Flexible cable conduit capable
	Silicone-free
	Free of substances which would hinder coating with paint or varnish
	flexible
Ambient temperature (operation)	-40 °C ... 80 °C (cable, fixed installation)
	-25 °C ... 80 °C (Cable, flexible installation)

Environmental and real-life conditions

Ambient conditions

Degree of protection	IP65
	IP67
	IP68
Ambient temperature (operation)	-25 °C ... 90 °C (Plug / socket)
	-25 °C ... 80 °C (cable, fixed installation)
	-5 °C ... 80 °C (Cable, flexible installation)

SAC-5P-M12MS/ 2,0-PUR/M12FS BK - Sensor/actuator cable



1544235

<https://www.phoenixcontact.com/us/products/1544235>

Drawings

Schematic diagram

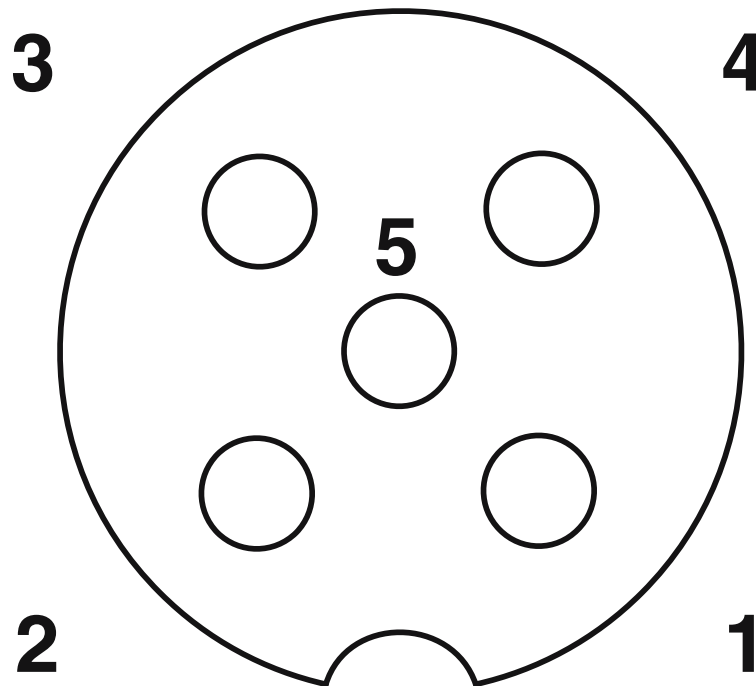

Pin assignment M12 socket, 5-pos., A-coded, socket side view

Schematic diagram

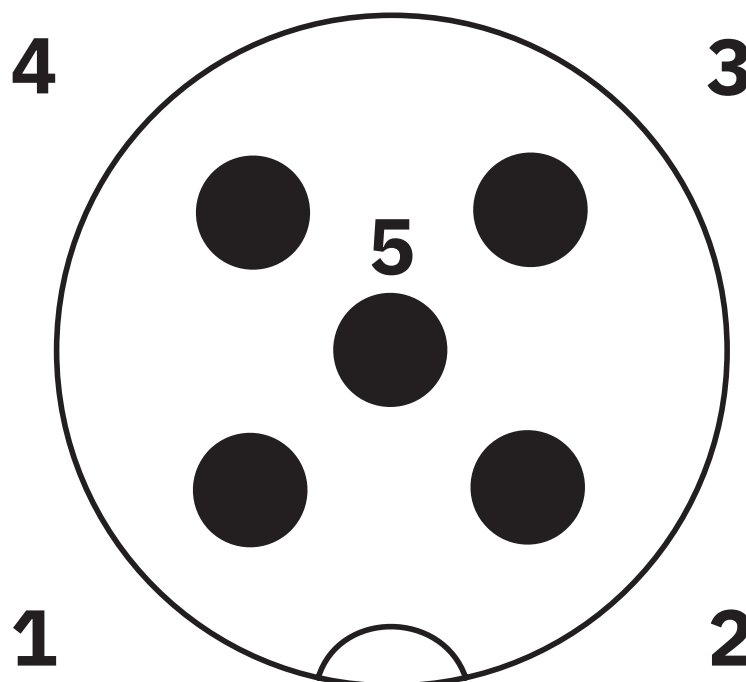

Pin assignment M12 male connector, 5-pos., A-coded, male side

SAC-5P-M12MS/ 2,0-PUR/M12FS BK - Sensor/actuator cable



1544235

<https://www.phoenixcontact.com/us/products/1544235>

Dimensional drawing

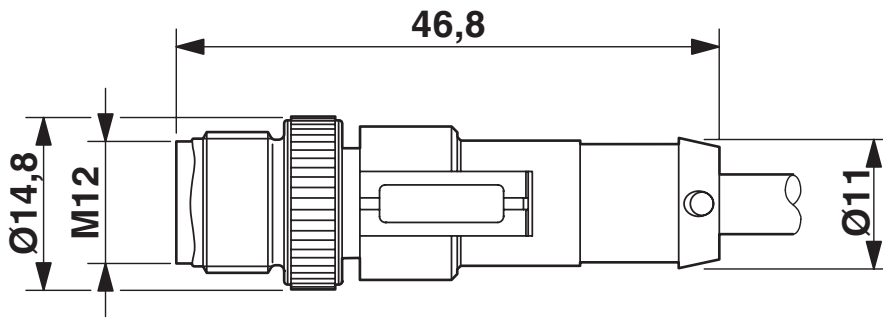

Plug, M12 x 1, straight, shielded

Dimensional drawing

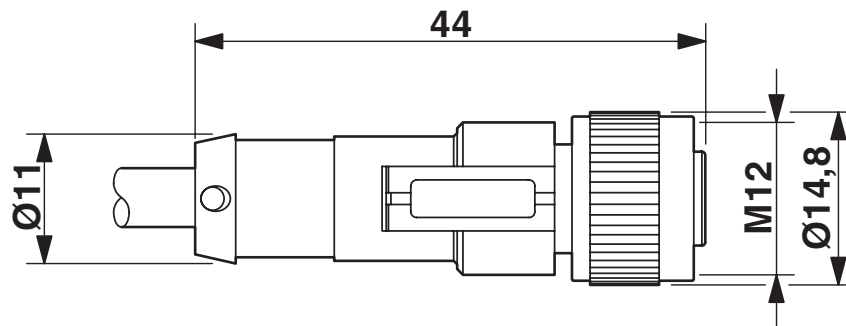

M12 x 1 socket, straight

SAC-5P-M12MS/ 2,0-PUR/M12FS BK - Sensor/actuator cable





1544235

<https://www.phoenixcontact.com/us/products/1544235>

Approvals

To download certificates, visit the product detail page: <https://www.phoenixcontact.com/us/products/1544235>

 UL Listed Approval ID: FILE E 221474				
	Nominal voltage U_N	Nominal current I_N	Cross section AWG	Cross section mm^2
	125 V	4 A	-	-

 cUL Listed Approval ID: FILE E 221474				
	Nominal voltage U_N	Nominal current I_N	Cross section AWG	Cross section mm^2
	125 V	4 A	-	-

 EAC-RoHS Approval ID: RU D-DE.HB35.B.00387	
---	--

cULus Listed

SAC-5P-M12MS/ 2,0-PUR/M12FS BK - Sensor/actuator cable



1544235

<https://www.phoenixcontact.com/us/products/1544235>

Classifications

ECLASS

ECLASS-11.0	27060311
ECLASS-12.0	27060311
ECLASS-13.0	27060311

ETIM

ETIM 8.0	EC001855
----------	----------

UNSPSC

UNSPSC 21.0	26121600
-------------	----------

SAC-5P-M12MS/ 2,0-PUR/M12FS BK - Sensor/actuator cable



1544235

<https://www.phoenixcontact.com/us/products/1544235>

Environmental product compliance

China RoHS	Environmentally friendly use period: unlimited = EFUP-e
	No hazardous substances above threshold values

Phoenix Contact 2023 © - all rights reserved
<https://www.phoenixcontact.com>

Phoenix Contact USA
586 Fulling Mill Road
Middletown, PA 17057, United States
(+717) 944-1300
info@phoenixcon.com