

### DESCRIPTION

The LM2904DR consists of two independent high gain, internally frequency compensated operational amplifier. It can be operated from a single power supply and also split power supplies.

### FEATURES

- \*Internally frequency compensated for unity gain.
- \*Wide power supply range 3V - 32V.
- \*Input common-mode voltage range include ground.
- \*Large DC voltage gain.

### APPLICATIONS

- \*General purpose amplifier.
- \*Transducer amplifier.

### PIN CONFIGURATIONS

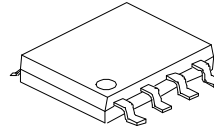

SOP-8

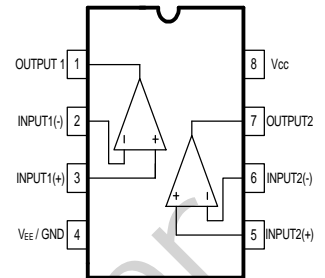

### BLOCK DIAGRAM

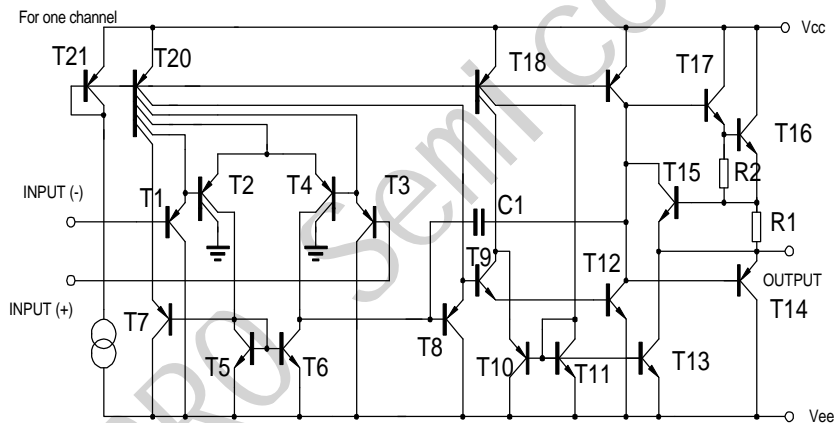

### ABSOLUTE MAXIMUM RATINGS

PARAMETER	SYMBOL	VALUE	UNIT
Supply Voltage	Vcc	+16 or 32	V
Differential Input Voltage	VI(DIFF)	32	V
Input Voltage	VI	-0.3 ~ +32	V
Output Short to Ground		Continuous	
Operating Temperature Range	TOPR	0 ~ +70	°C
Storage Temperature Range	TSTG	-65 ~ +150	°C

**ELECTRICAL CHARACTERISTICS** ( $V_{CC}=5.0V, V_{EE}=GND, T_A=25^{\circ}C$ , unless otherwise specified) ©

PARAMETER	SYMBOL	TEST CONDITION	MIN	TYP	MAX	UNIT
Input Offset Voltage	VIO	$V_{CM}=0V$ to $V_{CC}-1.5V$ $V_{O(P)}=1.4V, R_S=0\Omega$		2.9	7.0	mV
Input Offset Current	IIO			5	50	nA
Input Bias Current	IBIAS			45	250	nA
Input Common Mode Voltage	VI(R)	$V_{CC}=30V$	0		$V_{CC}-1.5$	V
Power Supply Current	ICC	$R_L=\infty, V_{CC}=30V$		0.8	2.0	mA
		$R_L=\infty$ , Full Temperature Range		0.5	1.2	mA
Large Signal Voltage Gain	GV	$V_{CC}=15V, R_L \geq 2K\Omega$ $V_{O(P)}=1V$ to $11V$	25	100		V/mV
Output Voltage Swing	VO(H)	$V_{CC}=30V, R_L=2K\Omega$	26			V
		$V_{CC}=30V, R_L=10K\Omega$	27	28		V
	VO(L)	$V_{CC}=5V, R_L \geq 10K\Omega$		5	20	mV
Common Mode Rejection Ratio	CMRR		65	80		dB
Power Supply Rejection Ratio	PSRR		65	100		dB
Channel Separation	CS	$f=1KHZ$ to $20KHZ$		120		dB
Short Circuit Current to Ground	ISC			40	60	mA
Output Current	ISOURCE	$V_I(+)=1V, V_I(-)=0V$ $V_{CC}=15V, V_{O(P)}=2V$	20	30		mA
	ISINK	$V_I(+)=0V, V_I(-)=1V$ $V_{CC}=15V, V_{O(P)}=2V$	10	15		mA
		$V_I(+)=0V, V_I(-)=1V$ $V_{CC}=15V, V_{O(P)}=200mV$	12	100		mA
Differential Input Voltage	VI(DIFF)				$V_{CC}$	V

TYPICAL PERFORMANCE CHARACTERISTICS

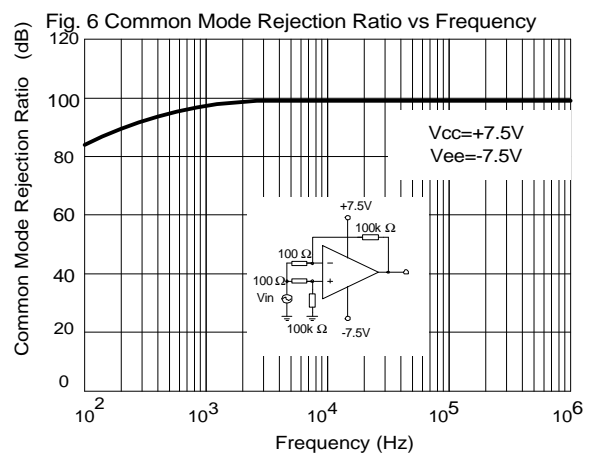
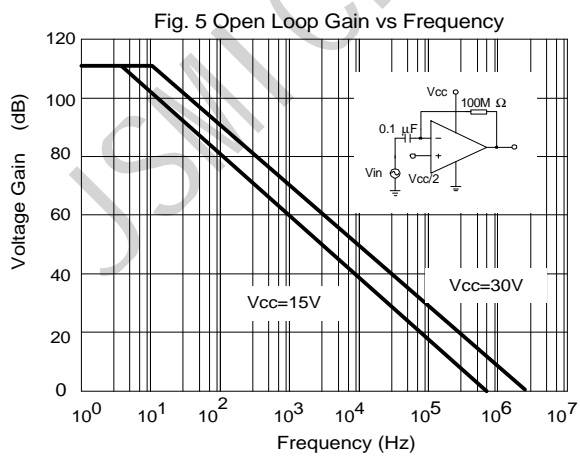
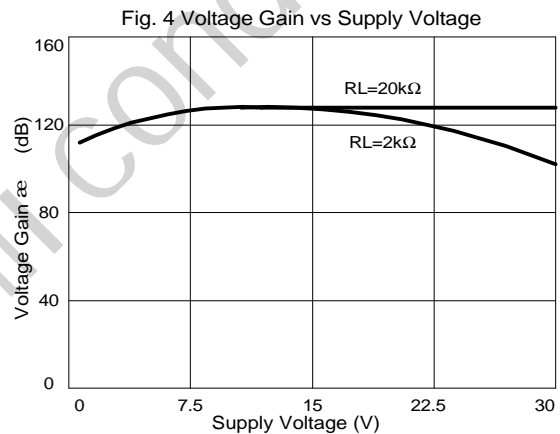
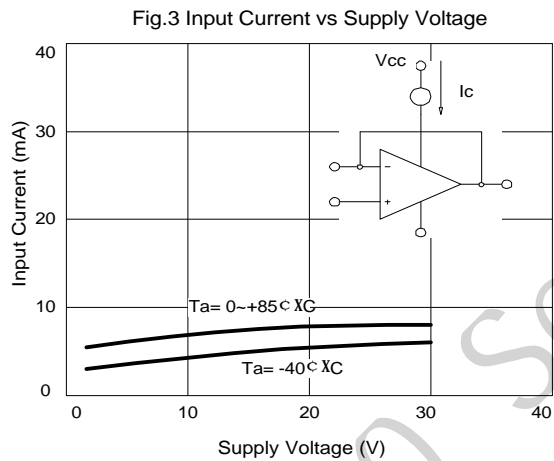
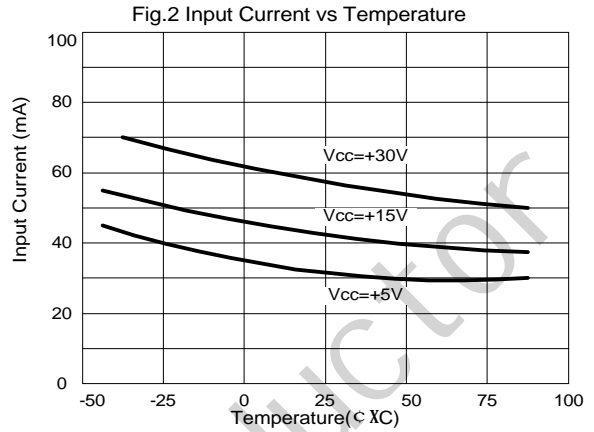
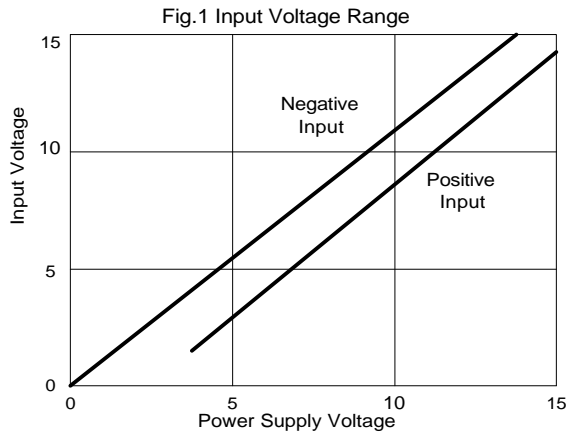

Fig. 7 Voltage Follower Pulse Response

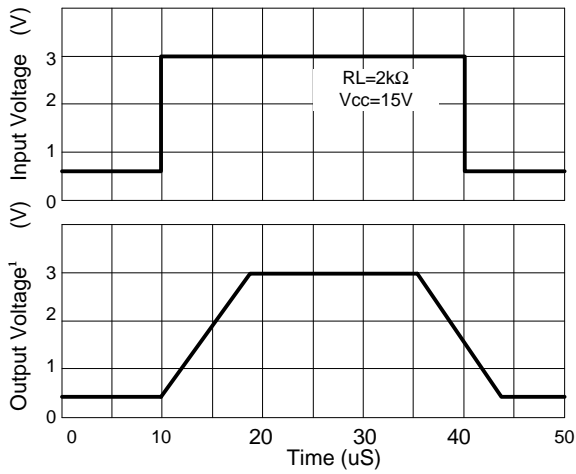

Fig. 8 Voltage Follower Response (Small Signal)

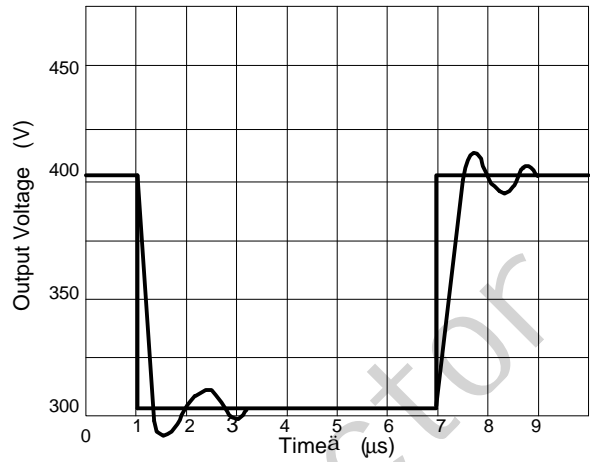

Fig. 9 Gain vs Large Signal Frequency

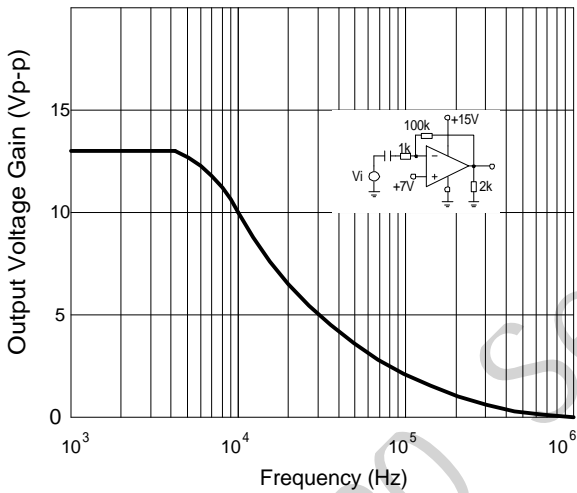

Fig. 10 Output Current Sinking vs Output Voltage

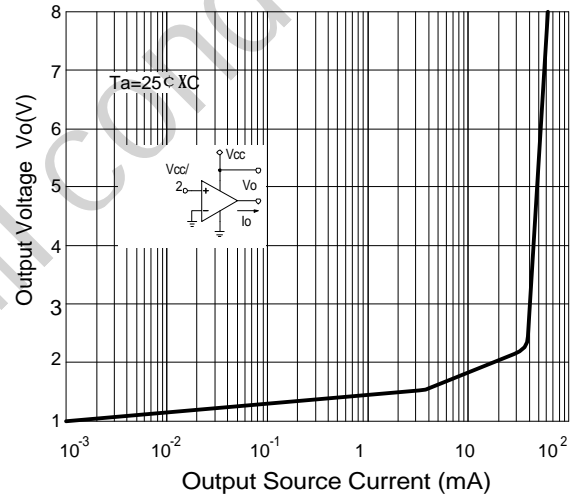

Fig. 11 Output Sink Current vs Output Voltage

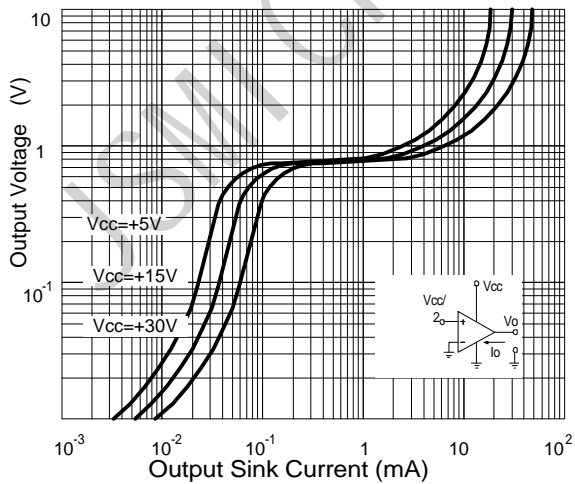
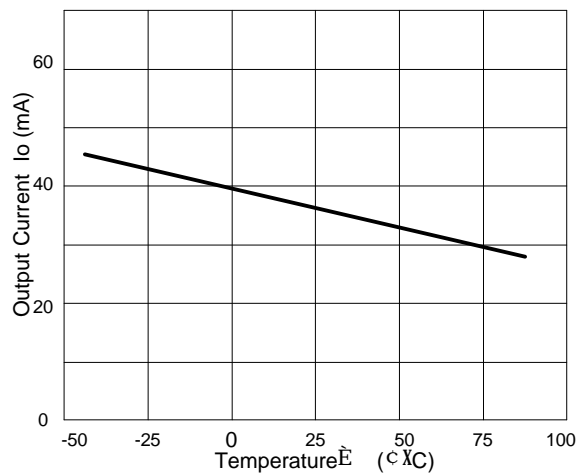

Fig. 12 Current Limiting vs Temperature



**外形尺寸图 / Package Dimensions**

SOP-8

Dimensions in mm

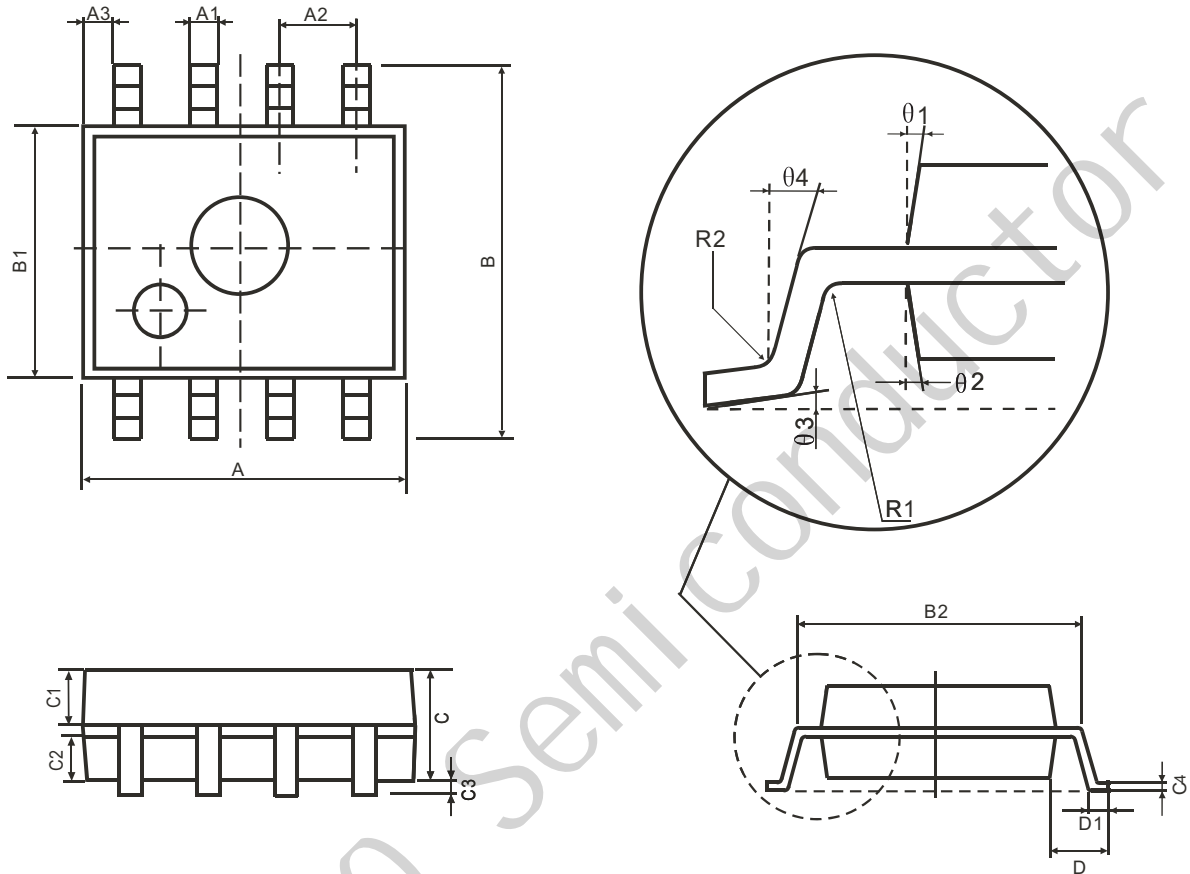

符号	尺寸(mm)		符号	尺寸(mm)	
	最小值	最大值		最小值	最大值
A	4.95	5.15	C3	0.05	0.20
A1	0.37	0.47	C4	0.20(典型值)	
A2	1.27(典型值)		D	1.05(典型值)	
A3	0.41(典型值)		D1	0.40	0.60
B	5.80	6.20	R1	0.07(典型值)	
B1	3.80	4.00	R2	0.07(典型值)	
B2	5.0(典型值)		theta1	17°(典型值)	
C	1.30	1.50	theta2	13°(典型值)	
C1	0.55	0.65	theta3	4°(典型值)	
C2	0.55	0.65	theta4	12°(典型值)	