

REV.	ECN NO.	DESCRIPTION	DRAW	CHECK	APPD.	DATE
A0	ECN130722023	新发行	xiaoch	—	—	13-07-22

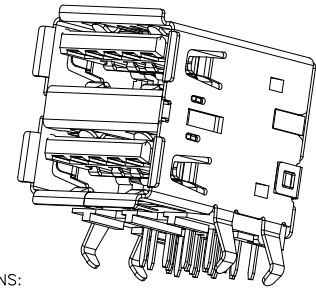

SPECIFICATIONS:
 Contact current Rating:
 1.8 Amperes for pin1&pin4.
 0.25 Amperes other contacts
 Dielectric Withstanding Voltage:AC 100V(RMS)
 Insulation resistance:100Megohms Minimum.
 Contact Resistance:
 30mΩ Max for pin1&pin4
 50mΩMax for other contacts
 Mechanical Characteristics:
 Mating Force:35 Newtons.Maximum
 Unmating Force:10 Newtons.Minimum.
MATERIAL: 8N Min After Durability
 Housing: PBT+30%GF 94V-0 COLOR:BLUE
 Contact: copper alloy(T=0.25mm)
 Shell: Brass
PLATING:
 Contact: Au Plated on contact area
 Tin Plated on solder area
 Nickel underplating over all
 Shell: Nickel Plated
 operating Temperature:--55i±to+85i±

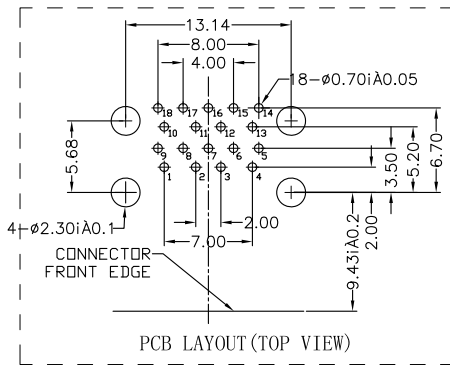
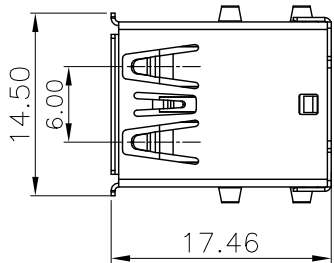
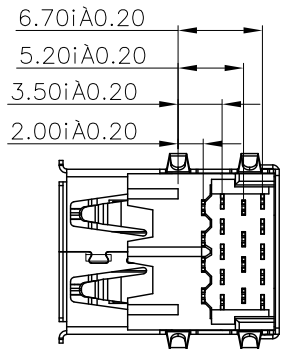
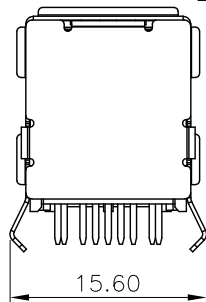
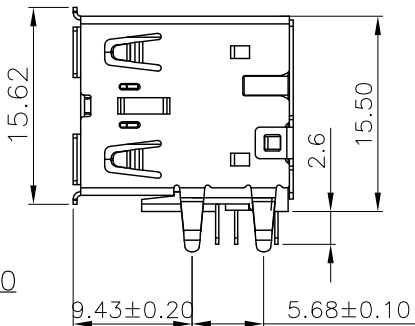
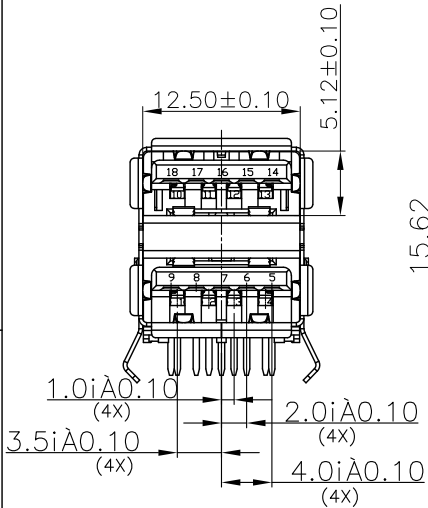

Pin Number	Signal Name	Pin Number	Signal Name
1/10	VBUS	5/14	SSRX-
2/11	D-	6/15	SSRX+
3/12	D+	7/16	GND
4/13	GND	8/17	SSTX-
Shell	Shield	9/18	SSTX+

HJ-Tech 东莞市皇捷通讯科技有限公司
 手机: 15015262131 手机: 13714786106

UNLESS OTHERWISE SPECIFIED TOLERANCES	APPROVAL	日期	品名	USB 3.0 AF双层90° DIP
	制图 xiaoch	2011.08.22	规格	
	审核 liuxiaobo	2011.08.24	料号	
	核准 stanly	2011.08.26	2LS00S0026	
	文件位置			
	ANGLE OF PROJECTION			字张 工程图号: 版本:
	DIMENSIONS			A4 DWG-USBAF-0003 A2
(METRIC)	(MM)	比例 1 : 1 状态码 A 页数 1 OF 1		