

General Description

The AGM15T05LL combines advanced trench MOSFET technology with a low resistance package to provide extremely low $R_{DS(ON)}$.

This device is ideal for load switch and battery protection applications.

Features

- Advance high cell density Trench technology
- Low $R_{DS(ON)}$ to minimize conductive loss
- Low Gate Charge for fast switching
- Low Thermal resistance
- 100% Avalanche tested
- 100% DVDS tested

Application

- MB/VGA Vcore
- SMPS 2nd Synchronous Rectifier
- POL application
- BLDC Motor driver

Product Summary

BVDSS	RDSON	ID
150V	5.0mΩ	180A

TOLL-8L Pin Configuration

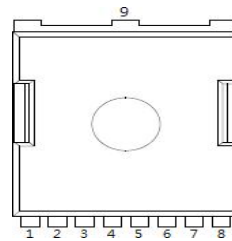

Pin	Description
1	Gate(G)
2,3,4,5,6,7,8	Source(S)
9	Drain(D)

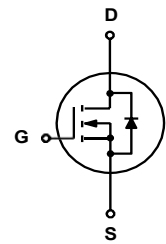

Package Marking and Ordering Information

Device Marking	Device	Device Package	Reel Size	Tape width	Quantity
AGM15T05LL	AGM15T05LL	TOLL-8L	330mm	25mm	2000

Table 1. Absolute Maximum Ratings (TC=25°C)

Symbol	Parameter	Value	Unit
VDS	Drain-Source Voltage (VGS=0V)	150	V
VGS	Gate-Source Voltage (VDS=0V)	±20	V
ID	Drain Current-Continuous(Tc=25°C) (Note 1)	180	A
	Drain Current-Continuous(Tc=100°C)	108	A
IDM (pluse)	Drain Current-Continuous@ Current-Pulsed (Note 2)	720	A
PD	Maximum Power Dissipation(Tc=25°C)	250	w
	Maximum Power Dissipation(Tc=100°C)	100	w
EAS	Avalanche energy (Note 3)	150	mJ
TJ,TSTG	Operating Junction and Storage Temperature Range	-55 To 150	°C

Table 2. Thermal Characteristic

Symbol	Parameter	Typ	Max	Unit
RθJA	Thermal Resistance Junction-ambient (Steady State) ¹	---	60	°C/W
RθJC	Thermal Resistance Junction-Case ¹	---	0.5	°C/W

Table 3. Electrical Characteristics (T_J=25°C unless otherwise noted)

Symbol	Parameter	Conditions	Min	Typ	Max	Unit
On/Off States						
BVDSS	Drain-Source Breakdown Voltage	VGS=0V ID=250μA	150	--	--	V
IDSS	Zero Gate Voltage Drain Current	VDS=150V,VGS=0V	--	--	1	μA
IGSS	Gate-Body Leakage Current	VGS=±20V,VDS=0V	--	--	±100	nA
VGS(th)	Gate Threshold Voltage	VDS=VGS,ID=250μA	2.0	2.8	4.0	V
gFS	Forward Transconductance	VDS=5V,ID=20A	--	18	--	S
RDS(on)	Drain-Source On-State Resistance	VGS=10V, ID=20A	--	5.0	6.0	mΩ
Dynamic Characteristics						
Ciss	Input Capacitance	VDS=75V,VGS=0V, F=1MHZ	--	5025	--	pF
Coss	Output Capacitance		--	410	--	pF
Crss	Reverse Transfer Capacitance		--	10	--	pF
Rg	Gate resistance	VGS=0V, VDS=0V,f=1.0MHz	--	--	--	Ω
Switching Times						
td(on)	Turn-on Delay Time	VGS=10V,VDS=75V, ID=80A,RGEN=6Ω	--	25	--	nS
tr	Turn-on Rise Time		--	31	--	nS
td(off)	Turn-Off Delay Time		--	60	--	nS
tf	Turn-Off Fall Time		--	20	--	nS
Qg	Total Gate Charge	VGS=10V, VDS=75V, ID=80A	--	19	--	nC
Qgs	Gate-Source Charge		--	11	--	nC
Qgd	Gate-Drain Charge		--	12	--	nC
Source-Drain Diode Characteristics						
ISD	Source-Drain Current(Body Diode)		--	--	180	A
VSD	Forward on Voltage	VGS=0V,IS=10A	--	--	1.2	V
trr	Reverse Recovery Time	IF=10A , di/dt=100A/μs , TJ=25°C	--	45	--	ns
Qrr	Reverse Recovery Charge		--	12	--	nc

Notes 1.The maximum current rating is package limited.

Notes 2.Repetitive Rating: Pulse width limited by maximum junction temperature

Notes 3.EAS condition: T_J=25°C

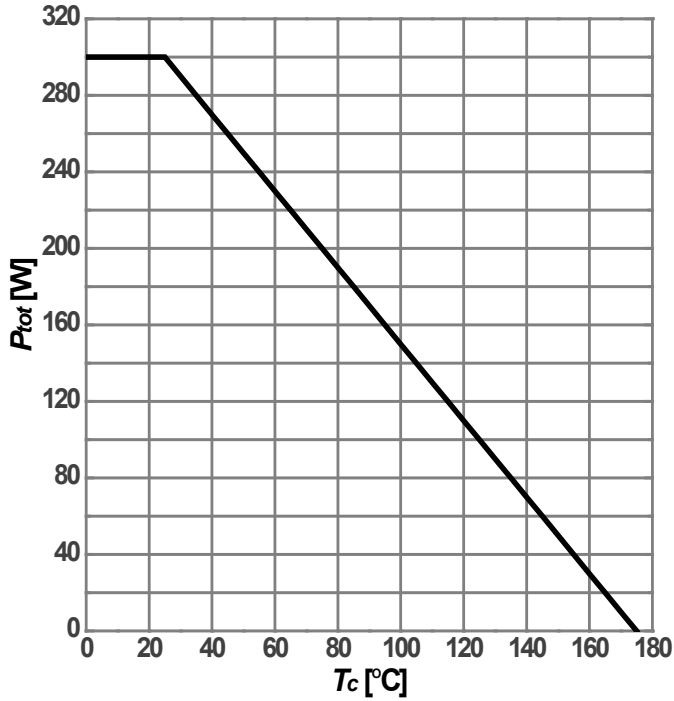
Diagram 1: Power dissipation

$$P_{tot} = f(T_c)$$

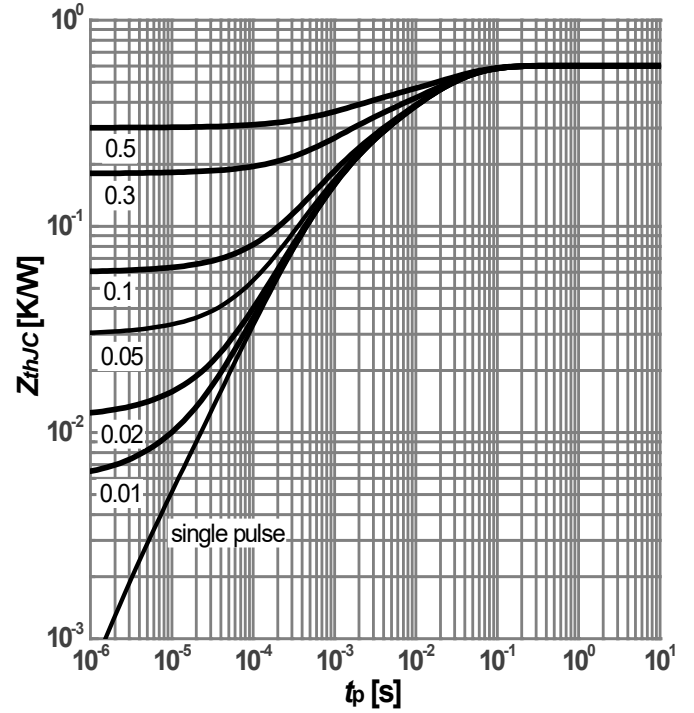
Diagram 2: Max. transient thermal impedance

$$Z_{thJC} = f(t_p); \text{ parameter: } D = t_p/T$$

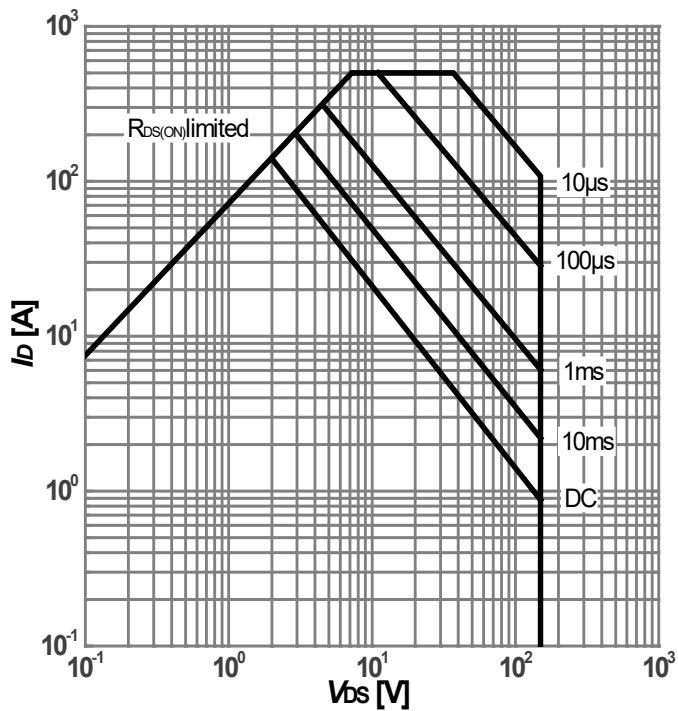
Diagram 3: Safe operating area

$$I_D = f(V_{GS}); T_j = 25^{\circ}C; D = 0; \text{ parameter: } t_p$$

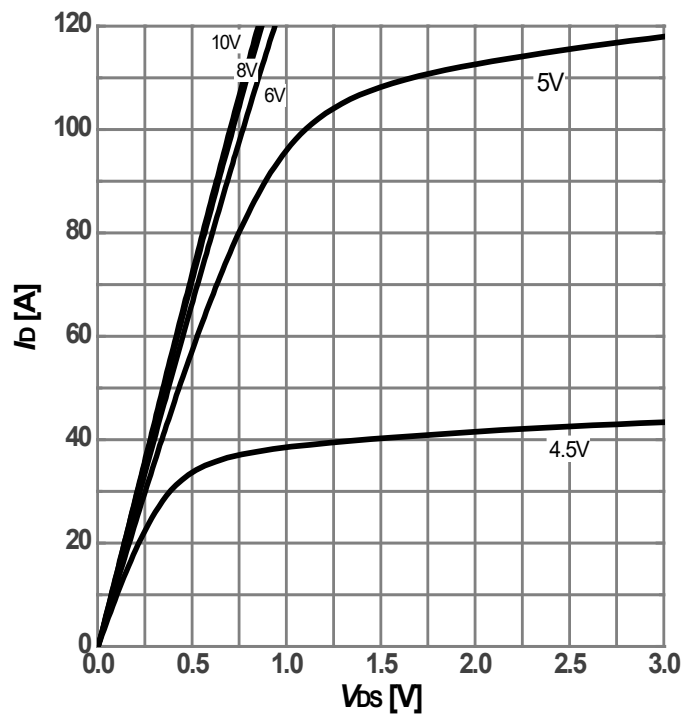
Diagram 4: Typ. output characteristics

$$I_D = f(V_{DS}); T_j = 25^{\circ}C; \text{ parameter: } V_{GS}$$

Diagram 5: Typ. transfer characteristics

 $I_D=f(V_{GS}); V_{DS}=5V; \text{parameter: } T_j$
Diagram 6: Gate threshold voltage vs. Junction temperature

 $V_{th}=f(T_j); I_D=250\mu\text{A}$
Diagram 7: On-state resistance vs. Drain current

 $R_{DS(on)}=f(I_D); T_j=25^\circ\text{C}; \text{parameter: } V_{GS}$
Diagram 8: On-state resistance vs. Junction temperature

 $R_{DS(on)}=f(T_j); I_D=20A; V_{GS}=10V$

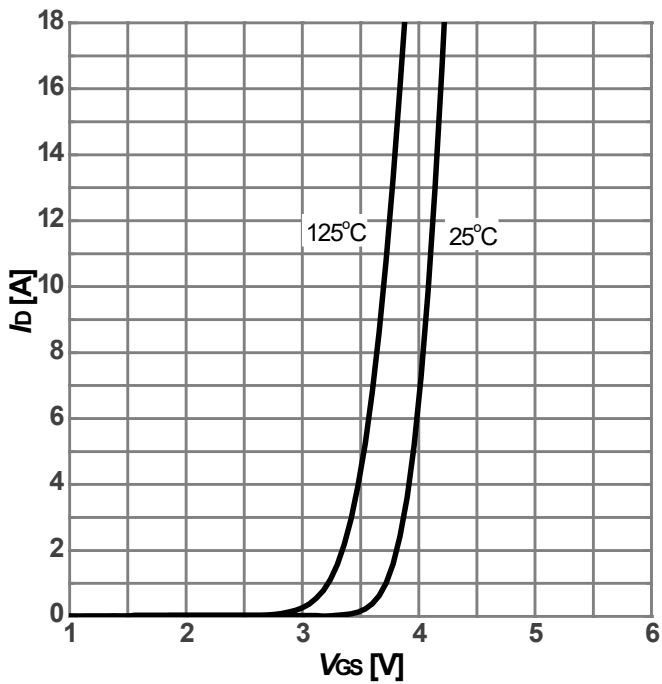
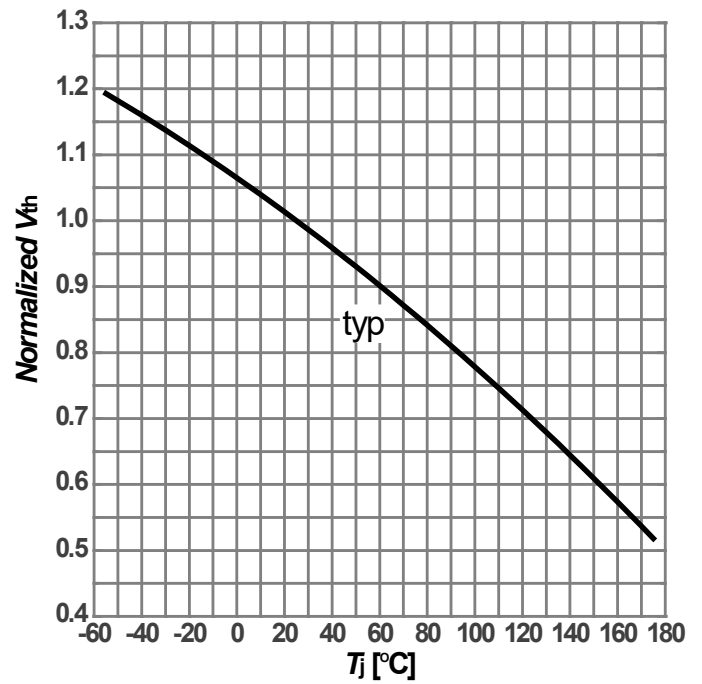
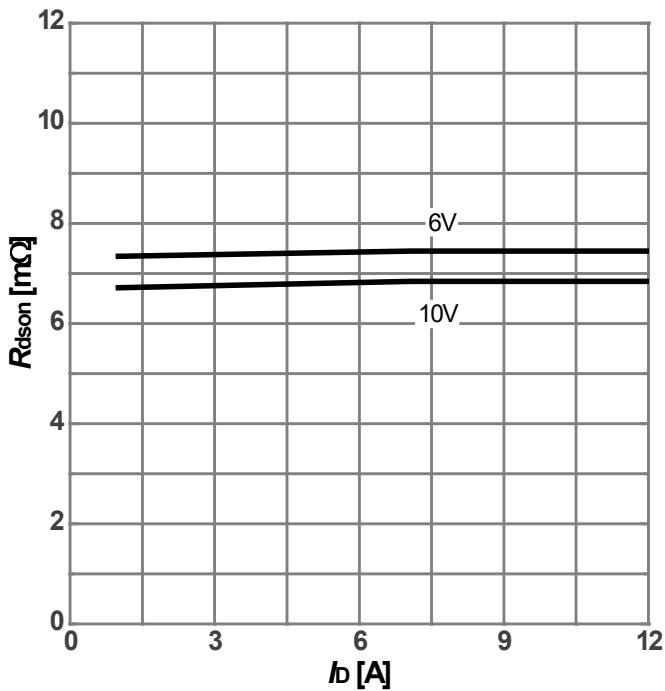
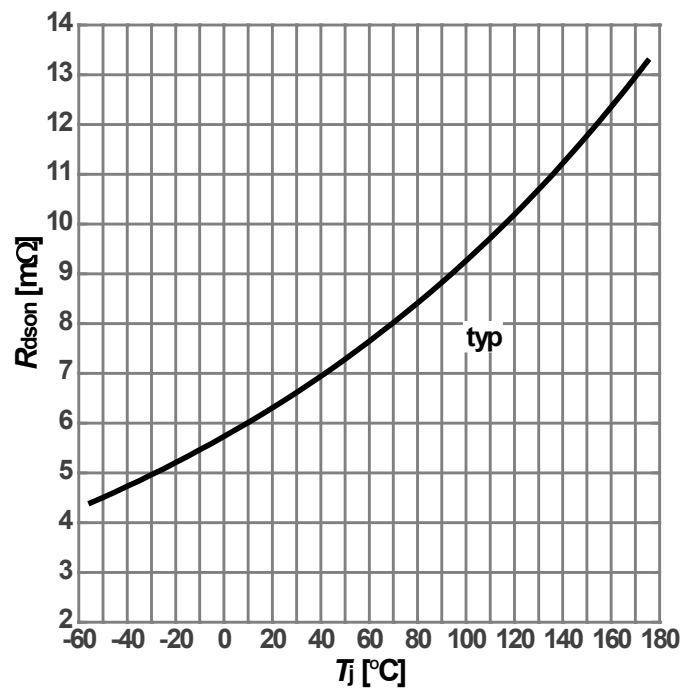
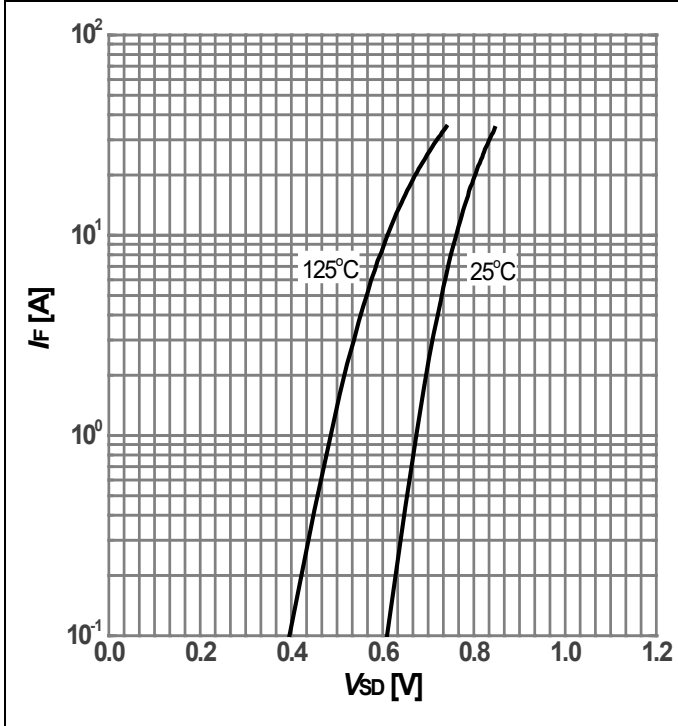
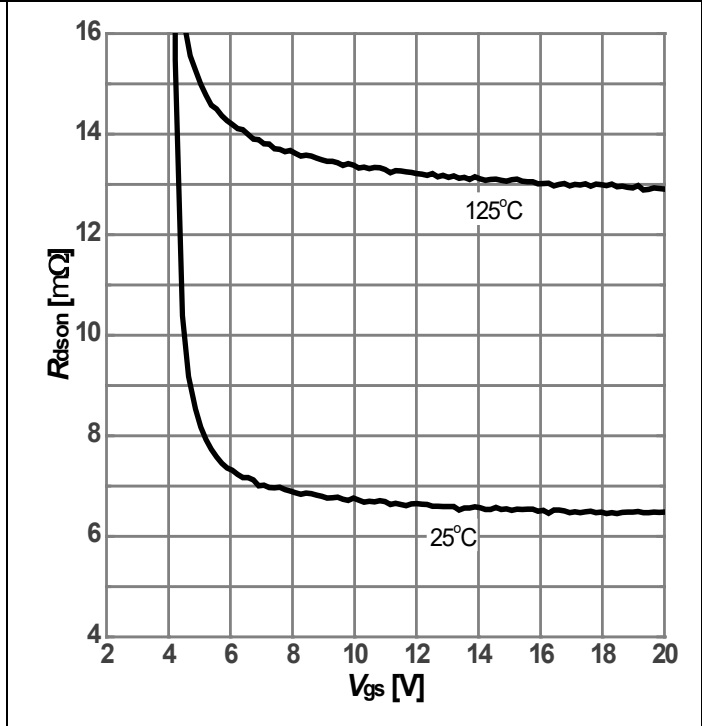
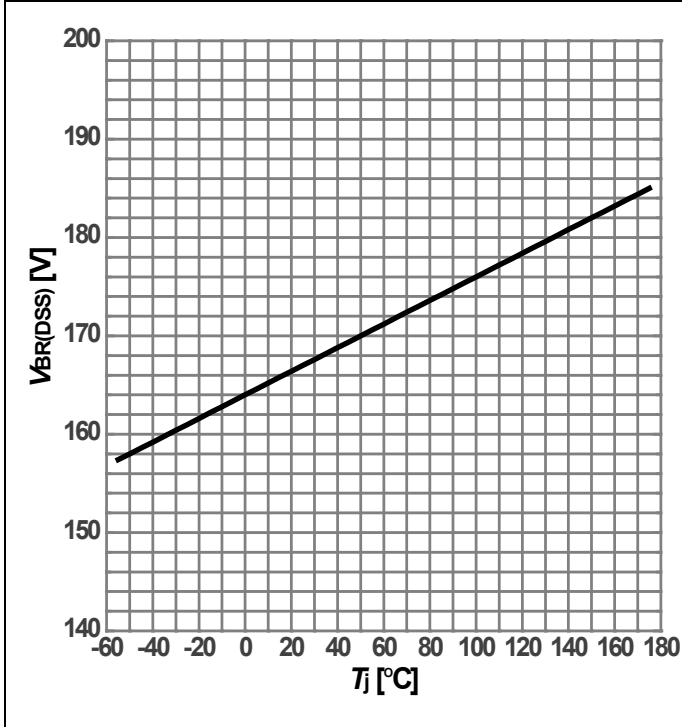
Diagram 9: Forward characteristics of reverse diode

$$I_F = f(V_{SD}); \text{ parameter: } T_j$$

Diagram 10: On-state resistance vs. V_{GS} characteristics

$$R_{DS(on)} = f(V_{GS}); I_D = 20A; \text{ parameter: } T_j$$

Diagram 11: Breakdown Voltage Variation vs. Temperature

$$V_{BR(DSS)} = f(T_j); I_D = 250\mu A$$

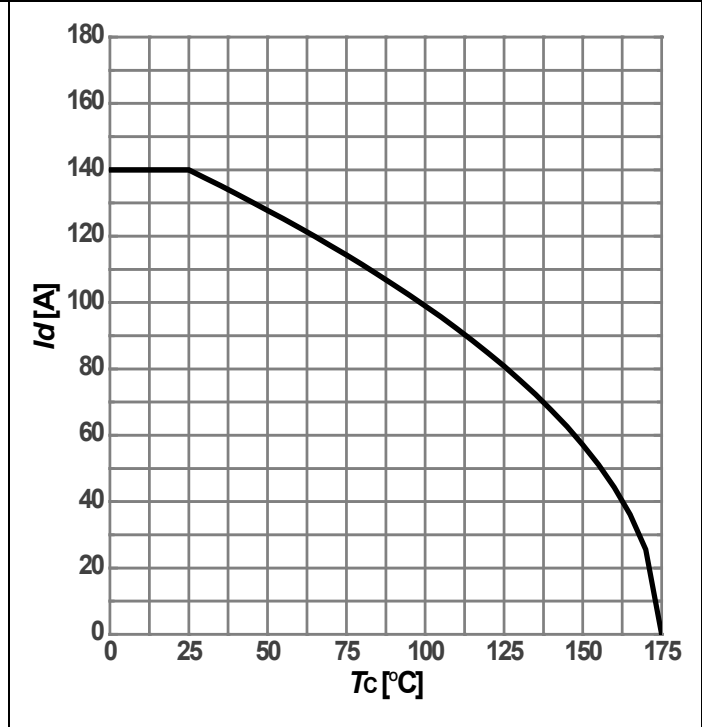
Diagram 12: Maximum Drain Current

$$I_D = f(T_c); V_{GS} = 10V$$

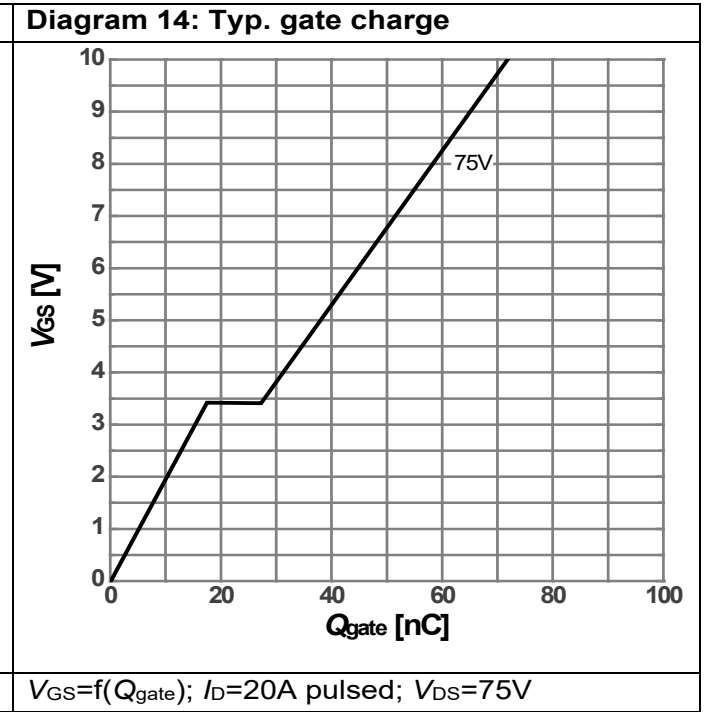
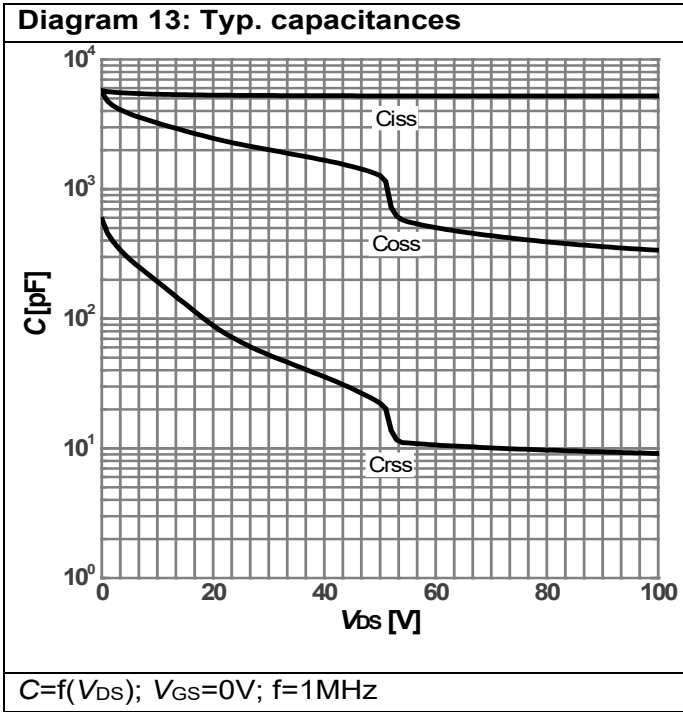

Table 7. Diode characteristics

Test circuit for diode characteristics	Diode recovery waveform

Table 8. Switching times

Switching times test circuit for inductive load	Switching times waveform

Table 9. Unclamped inductive load

Unclamped inductive load test circuit	Unclamped inductive waveform

TOLL-8L Package

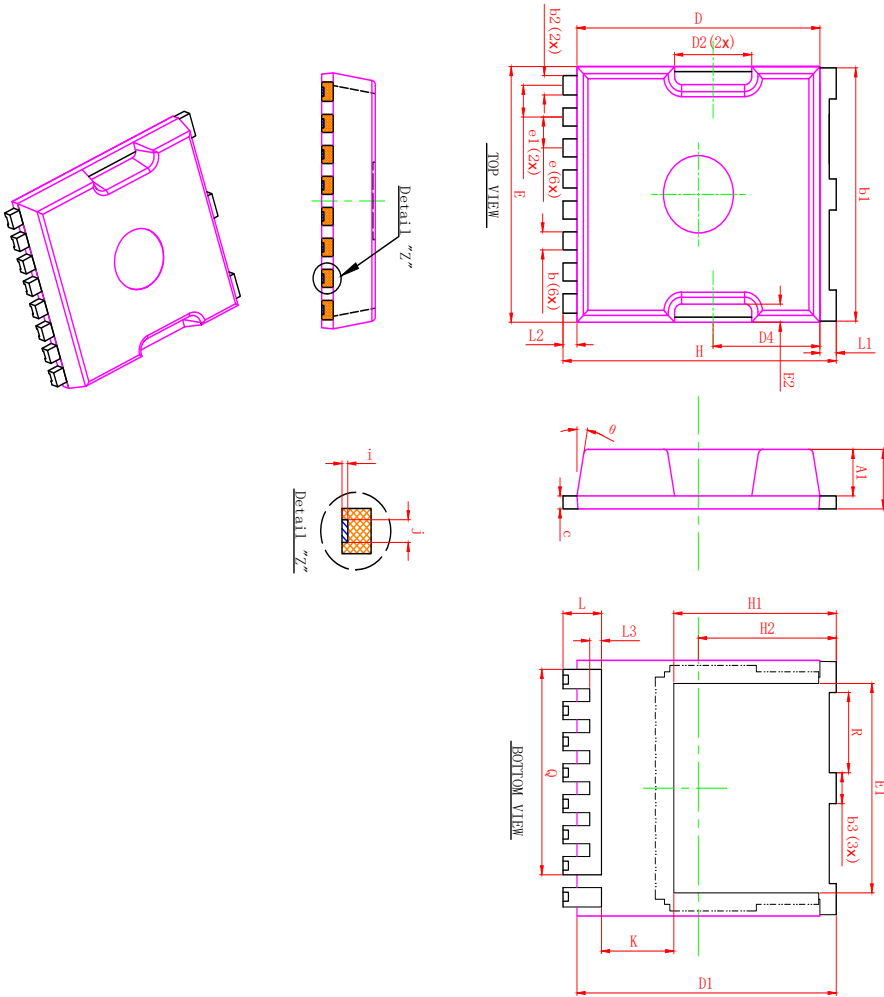

SYMBOL	MILLIMETER		
	MIN.	NOM.	MAX.
A	2.200	2.300	2.400
A1	1.700	1.800	1.900
b	0.600	0.700	0.800
b1	9.700	9.800	9.900
b2	0.650	0.750	0.850
b3	1.100	1.200	1.300
c	0.400	0.500	0.600
D	10.300	10.400	10.500
D1	11.000	11.100	11.200
D2	3.200	3.300	3.400
D4	4.470	4.570	4.670
E	9.800	9.900	10.000
E1	8.000	8.100	8.200
E2	0.500	0.600	0.700
e	1.200 BSC		
e1	1.225 BSC		
H	11.600	11.700	11.800
H1	6.950 BSC		
H2	5.900 BSC		
i	0.100 REF.		
j	0.350 REF.		
K	3.100 REF.		
L	1.550	1.650	1.750
L1	0.600	0.700	0.800
L2	0.500	0.600	0.700
L3	0.400	0.500	0.600
Q	7.950 REF.		
R	3.000	3.100	3.200
θ	10° REF.		

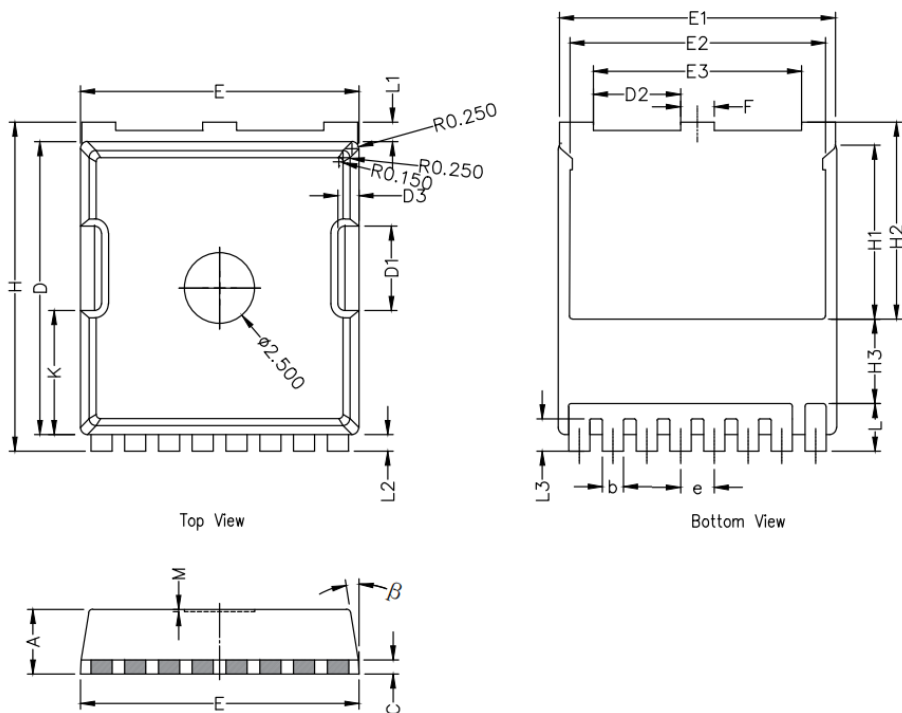

Symbols	Millimeters		
	MIN.	NOM.	MAX.
A	2.20	2.30	2.40
b	0.65	0.75	0.85
C	0.508 REF.		
D	10.25	10.40	10.55
D1	2.85	3.00	3.15
D2	2.95	3.10	3.25
D3	0.75 REF.		
E	9.75	9.90	10.05
E1	9.65	9.80	9.95
E2	8.95	9.10	9.25
E3	7.25	7.40	7.55
e	1.20 BSC		
F	1.05	1.20	1.35
H	11.55	11.70	11.85
H1	6.03	6.18	6.33
H2	6.85	7.00	7.15
H3	3.00 BSC		
L	1.55	1.70	1.85
L1	0.55	0.70	0.85
L2	0.45	0.60	0.75
L3	1.00	1.15	1.30
M	0.08 REF.		
β	8°	10°	12°
K	4.25	4.40	4.55

Disclaimer:

The information provided in this document is believed to be accurate and reliable. however, Shenzhen Core Control Electronics Technology Co., Ltd. does not assume any responsibility for the following consequences. Do not consider the use of such information or use beyond its scope.

The information mentioned in this document may be changed at any time without notice.

The products and information provided in this document do not infringe patents. Shenzhen Core Control Electronics Technology Co., Ltd. assumes no responsibility for any infringement of any other rights of third parties. The result of using such products and information.

This document is the third version issued on August 20th, 2023. This document replaces and Replace all previously provided information.

 It is a registered trademark of Shenzhen Core Control Electronics Technology Co., Ltd.

Copyright © 2017 Shenzhen Core Control Electronics Technology Co., Ltd. all rights reserved.