

● General Description

The AGM1095MAP combines advanced trench MOSFET technology with a low resistance package to provide extremely low $R_{DS(ON)}$.

This device is ideal for load switch and battery protection applications.

● Features

- Advance high cell density Trench technology
- Low $R_{DS(ON)}$ to minimize conductive loss
- Low Gate Charge for fast switching
- Low Thermal resistance

● Application

- MB/VGA Vcore
- SMPS 2nd Synchronous Rectifier
- POL application
- BLDC Motor driver

Product Summary

BVDSS	RDSON	ID
100V	96mΩ	7A
-100V	220mΩ	-6A

PDFN3.3*3.3 Pin Configuration

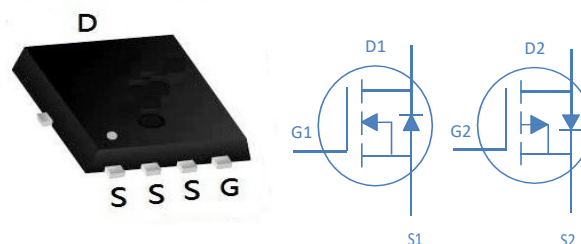

Package Marking and Ordering Information

Device Marking	Device	Device Package	Reel Size	Tape width	Quantity
AGM1095MAP	AGM1095MAP	PDFN3.3*3.3	330mm	12mm	5000

Table 1. Absolute Maximum Ratings (TA=25°C)

Symbol	Parameter	Rating		Units
		N-Ch	P-Ch	
V_{DS}	Drain-Source Voltage ($V_{GS}=0V$)	100	-100	V
V_{GS}	Gate-Source Voltage ($V_{DS}=0V$)	±20	±20	V
ID	Drain Current-Continuous($TC=25^{\circ}C$) ^(Note 1)	7.0	-6.0	A
	Drain Current-Continuous($TC=100^{\circ}C$)	4.2	-3.6	A
IDM (pulse)	Drain Current-Continuous@ Current-Pulsed ^(Note 2)	28	-24.5	A
P_D	Total Power Dissipation($TC=25^{\circ}C$)	33.7	32	W
	Total Power Dissipation($TC=100^{\circ}C$)	13.5	12.8	W
EAS	Avalanche energy ^(Note 3)	90	110	mJ
TJ,TSTG	Operating Junction and Storage Temperature Range	-55 To 150	-55 To 150	°C

Table 2. Thermal Characteristic

Symbol	Parameter	Typ	Max	Unit
$R_{\theta JA}$	Thermal Resistance Junction-ambient (Steady State) ¹	50	50	°C/W
$R_{\theta JC}$	Thermal Resistance Junction-Case ¹	3.7	3.9	°C/W

Table 3. N- Channel Electrical Characteristics (T_J=25°C unless otherwise noted)

Symbol	Parameter	Conditions	Min	Typ	Max	Unit
On/Off States						
BVDSS	Drain-Source Breakdown Voltage	VGS=0V ID=250μA	100	--	--	V
IDSS	Zero Gate Voltage Drain Current	VDS=100V,VGS=0V	--	--	1	μA
IGSS	Gate-Body Leakage Current	VGS=±20V,VDS=0V	--	--	±100	nA
VGS(th)	Gate Threshold Voltage	VDS=VGS,ID=250μA	1.0	--	2.1	V
gFS	Forward Transconductance	VDS=5V,ID=3A	--	7	--	S
RDS(on)	Drain-Source On-State Resistance	VGS=10V, ID=6A	--	96	120	mΩ
		VGS=4.5V, ID=3A	--	100	140	mΩ
Dynamic Characteristics						
Ciss	Input Capacitance	VDS=50V,VGS=0V, F=1MHZ	--	999	--	pF
Coss	Output Capacitance		--	46	--	pF
Crss	Reverse Transfer Capacitance		--	32	--	pF
Rg	Gate resistance	VGS=0V, VDS=0V,f=1.0MHz	--	--	--	Ω
Switching Times						
td(on)	Turn-on Delay Time	VGS=10V,VDS=30V, RL=15Ω,RGEN=2.5Ω	--	50	--	nS
tr	Turn-on Rise Time		--	2.9	--	nS
td(off)	Turn-Off Delay Time		--	17.3	--	nS
tf	Turn-Off Fall Time		--	2.8	--	nS
Qg	Total Gate Charge	VGS=10V, VDS=30V, ID=3A	--	25.4	--	nC
Qgs	Gate-Source Charge		--	4.2	--	nC
Qgd	Gate-Drain Charge		--	4.3	--	nC
Source-Drain Diode Characteristics						
ISD	Source-Drain Current(Body Diode)		--	--	7.0	A
VSD	Forward on Voltage	VGS=0V,IS=6A	--	--	1.2	V
trr	Reverse Recovery Time	IF=6A , di/dt=100A/μs , TJ=25°C	--	--	--	ns
Qrr	Reverse Recovery Charge		--	--	--	nc

Notes 1.The maximum current rating is package limited.

Notes 2.Repetitive Rating: Pulse width limited by maximum junction temperature

Notes 3.EAS condition: T_J=25°C

Table 3. P-Channel Electrical Characteristics (T_J=25°C unless otherwise noted)

Symbol	Parameter	Conditions	Min	Typ	Max	Unit
On/Off States						
BVDSS	Drain-Source Breakdown Voltage	VGS=0V ID=-250μA	-100	--	--	V
IDSS	Zero Gate Voltage Drain Current	VDS=-100V,VGS=0V	--	--	-1	μA
IGSS	Gate-Body Leakage Current	VGS=±20V,VDS=0V	--	--	±100	nA
VGS(th)	Gate Threshold Voltage	VDS=VGS,ID=-250μA	-1.2	-1.6	-2.1	V
gFS	Forward Transconductance	VDS=-5V,ID=-3A	--	7	--	S
RDS(on)	Drain-Source On-State Resistance	VGS=-10V, ID=-6A	--	220	250	mΩ
		VGS=-4.5V, ID=-3A	--	225	250	mΩ
Dynamic Characteristics						
Ciss	Input Capacitance	VDS=-50V,VGS=0V, F=1MHZ	--	1600	--	pF
Coss	Output Capacitance		--	86	--	pF
Crss	Reverse Transfer Capacitance		--	40	--	pF
Rg	Gate resistance	VGS=0V, VDS=0V,f=1.0MHz	--	1.2	--	Ω
Switching Times						
td(on)	Turn-on Delay Time	VGS=-10V,VDS=-50V, ID=-10A,RGEN=3.3Ω	--	12	--	nS
tr	Turn-on Rise Time		--	152	--	nS
td(off)	Turn-Off Delay Time		--	28	--	nS
tf	Turn-Off Fall Time		--	38	--	nS
Qg	Total Gate Charge	VGS=-10V, VDS=-50V, ID=-4A	--	33	--	nC
Qgs	Gate-Source Charge		--	4.3	--	nC
Qgd	Gate-Drain Charge		--	7.2	--	nC
Source-Drain Diode Characteristics						
ISD	Source-Drain Current(Body Diode)		--	--	-6.0	A
VSD	Forward on Voltage	VGS=0V,IS=-6A	--	--	-1.2	V
trr	Reverse Recovery Time	IF=-6A , dI/dt=100A/μs ,	--	--	--	ns
Qrr	Reverse Recovery Charge	TJ=25°C	--	--	--	nc

Notes 1.The maximum current rating is package limited.

Notes 2.Repetitive Rating: Pulse width limited by maximum junction temperature Notes

3.EAS condition: T_J=25°C

N- Channel 100V MOSFET

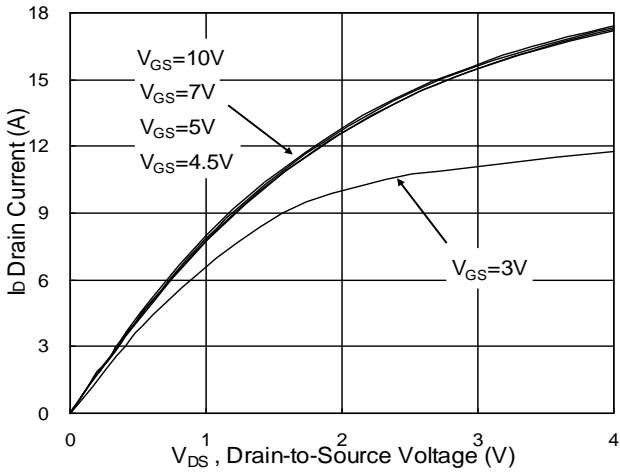

Fig.1 Typical Output Characteristics

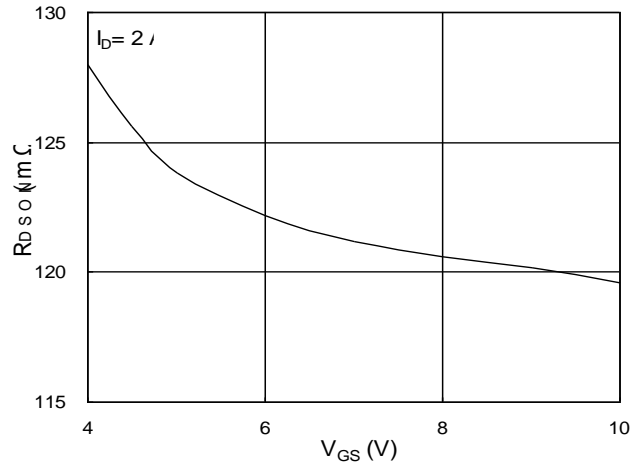

Fig.2 On-Resistance vs. Gate-Source

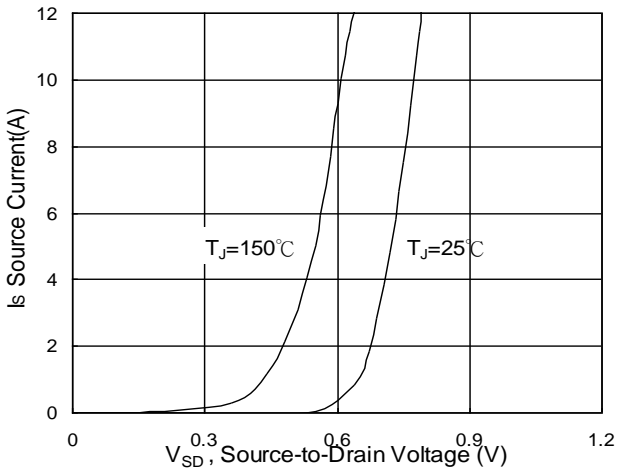

Fig.3 Forward Characteristics Of Reverse

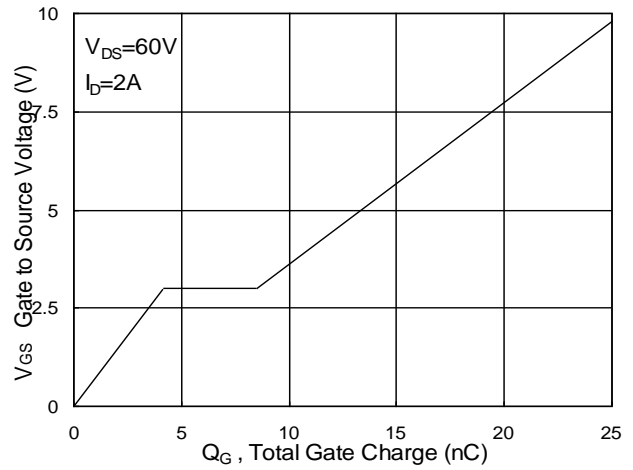
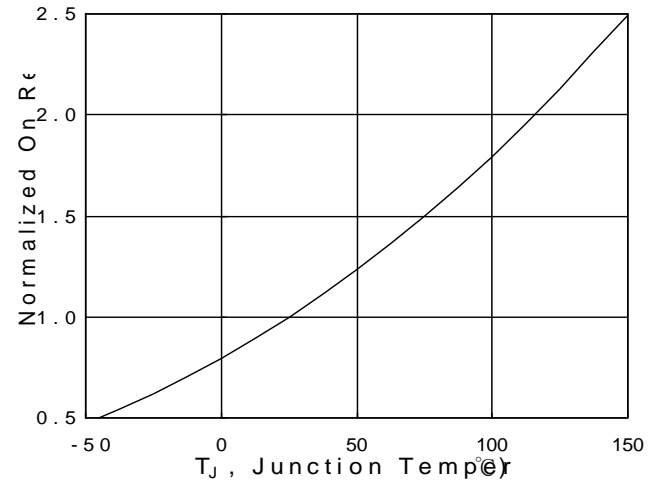
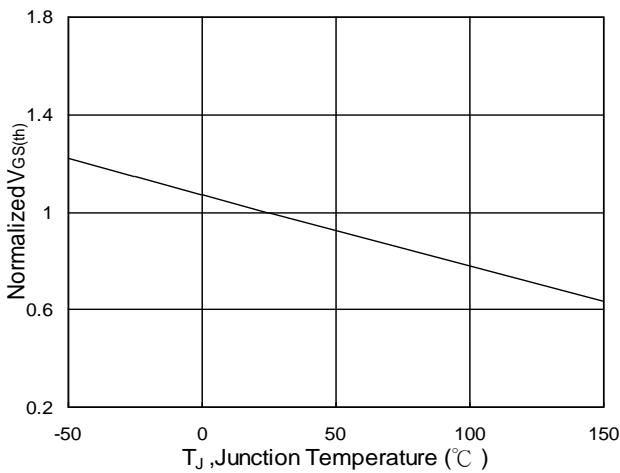

Fig.4 Gate-Charge Characteristics



N- Channel 100V MOSFET

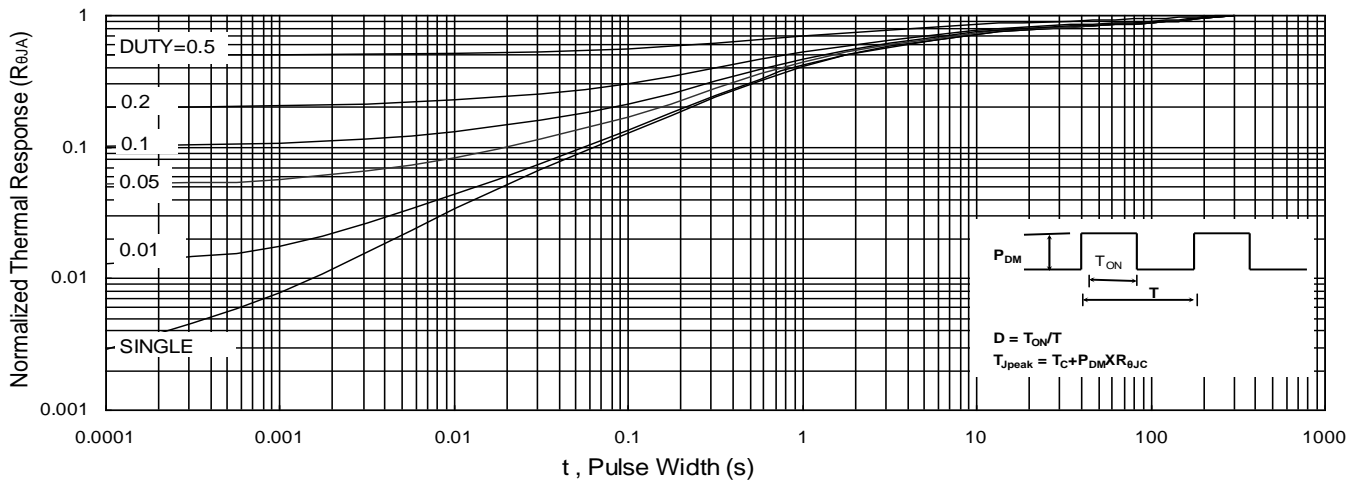
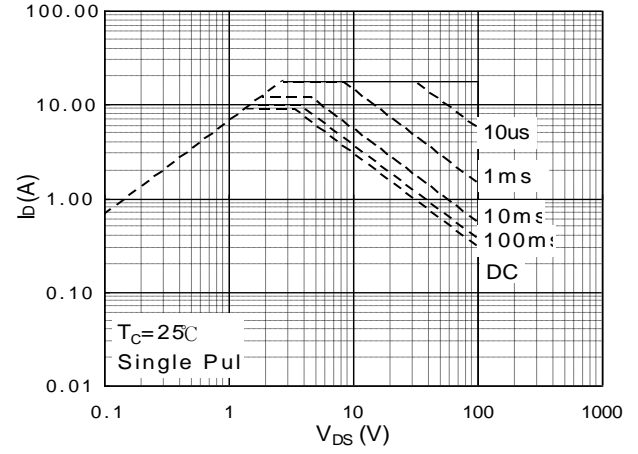
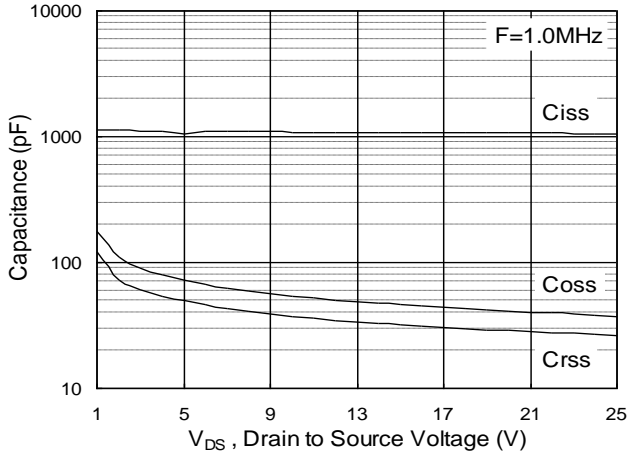
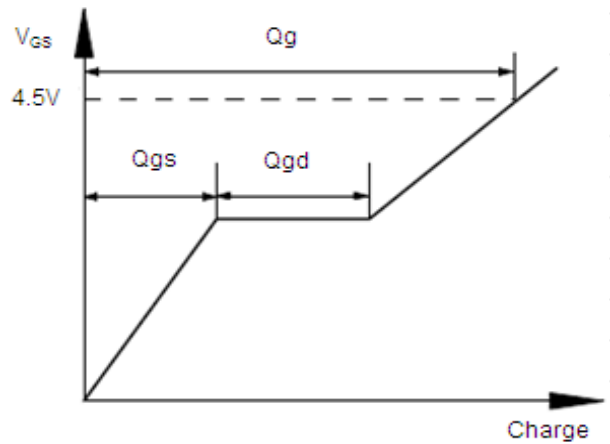
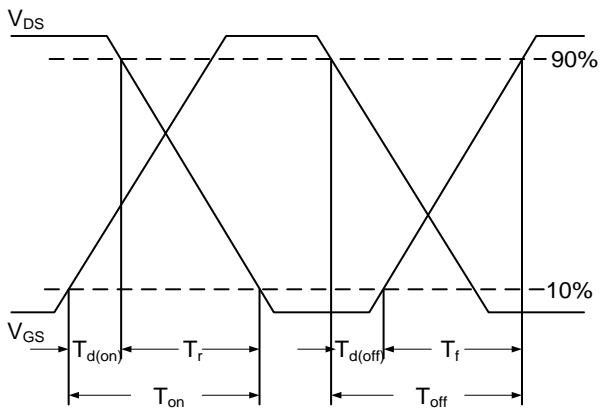

Fig.9 Normalized Maximum Transient Thermal Impedance



P- Channel 100V MOSFET

Test Circuit

1) E_{AS} Test Circuit

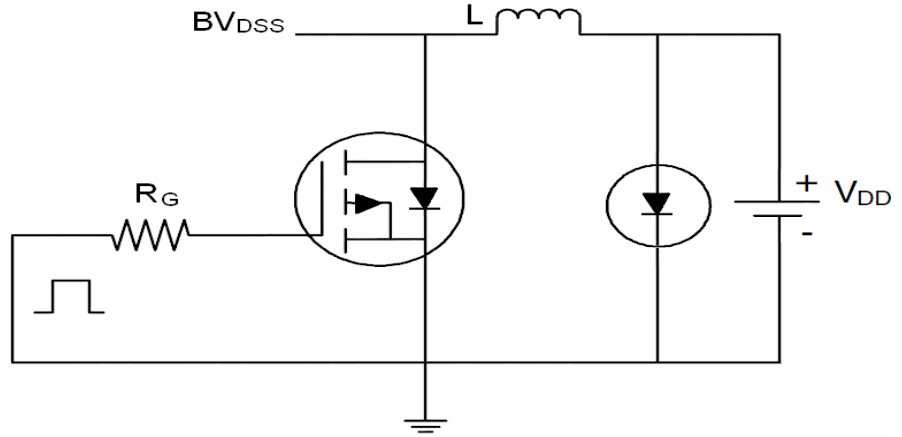

2) Gate Charge Test Circuit

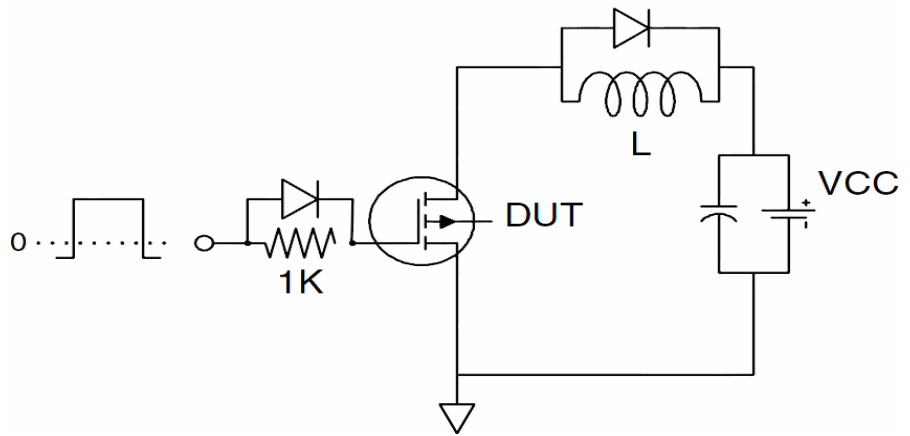

3) Switch Time Test Circuit

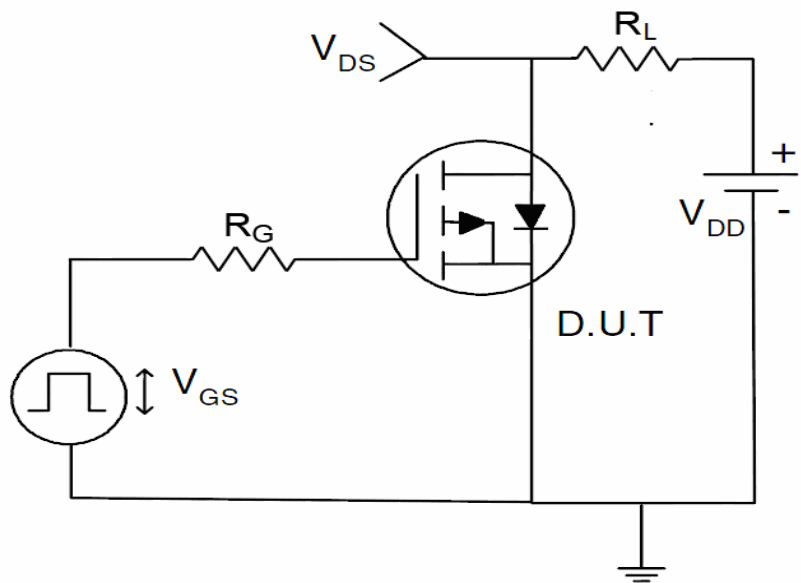

P- Channel 100V MOSFET

Typical Electrical and Thermal Characteristics (Curves)

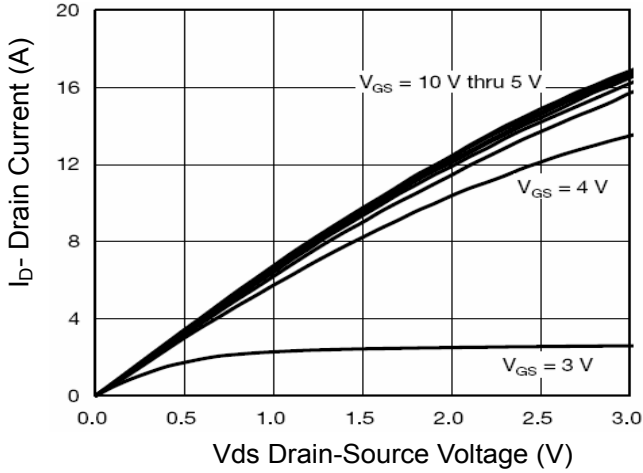

Figure 1 Output Characteristics

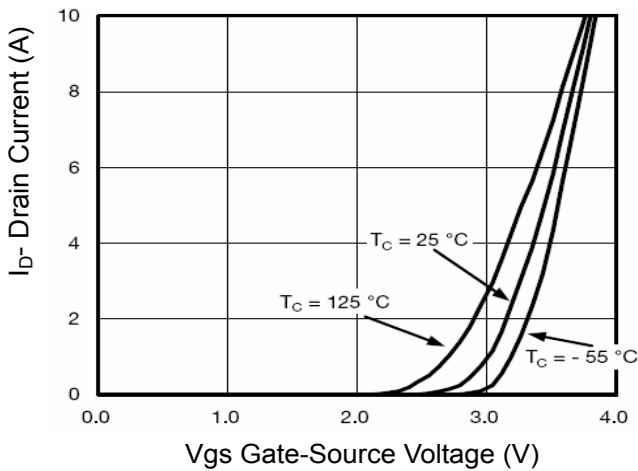

Figure 2 Transfer Characteristics

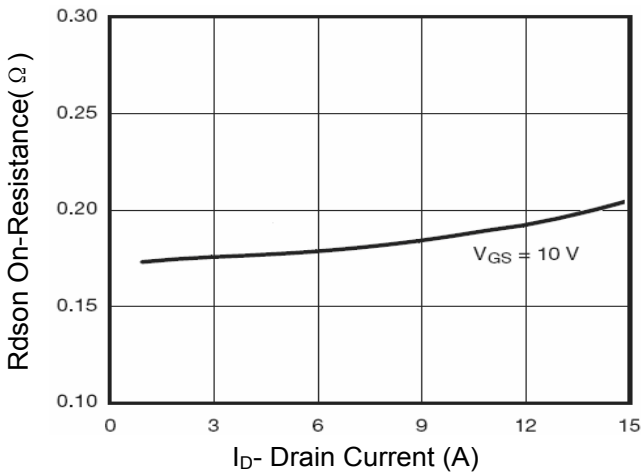

Figure 3 Rdson- Drain Current

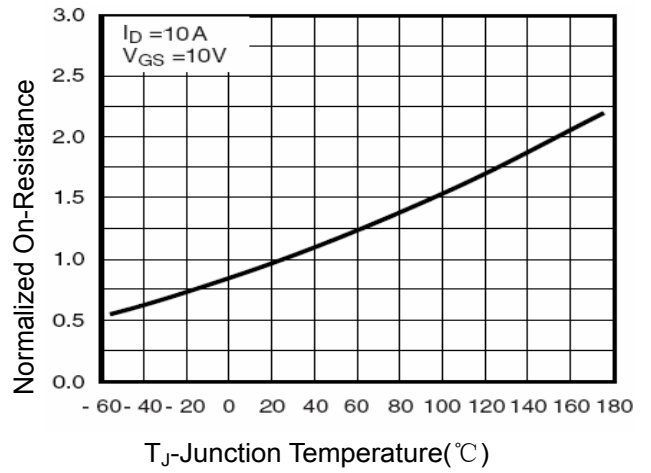

Figure 4 Rdson-Junction Temperature

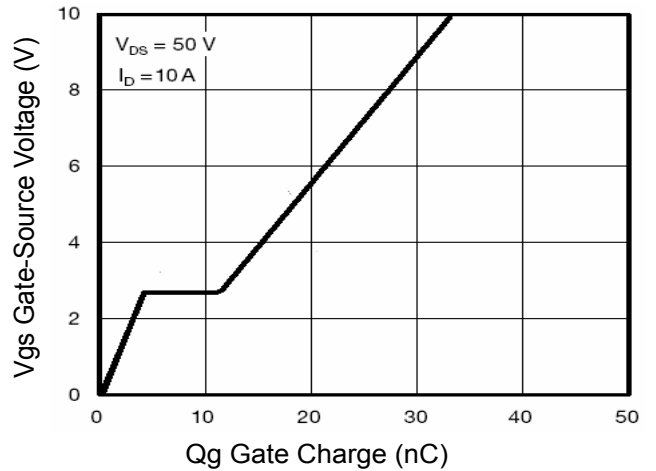

Figure 5 Gate Charge

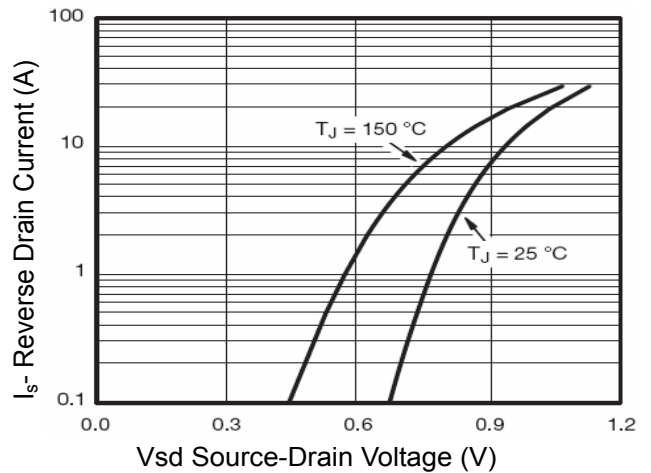
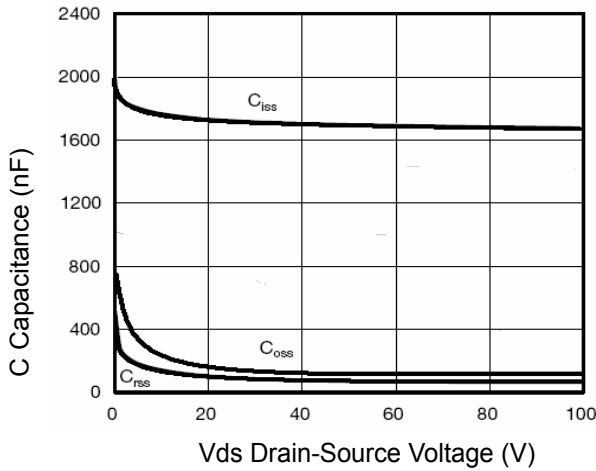
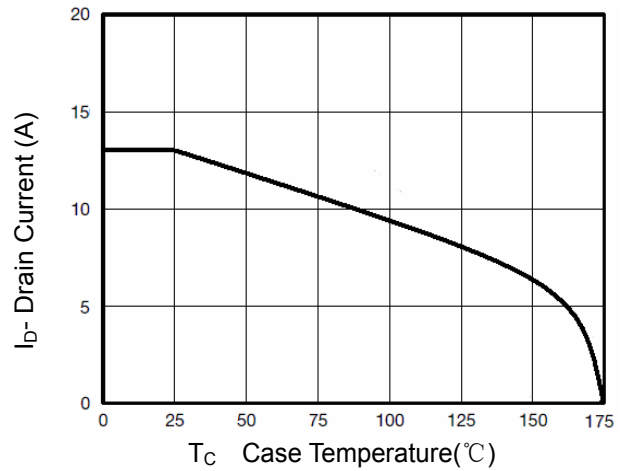
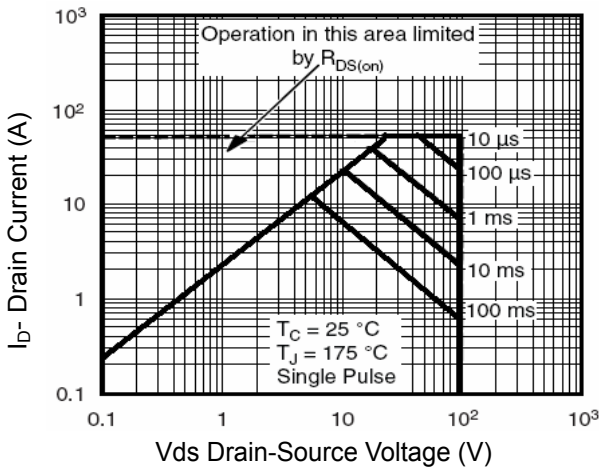
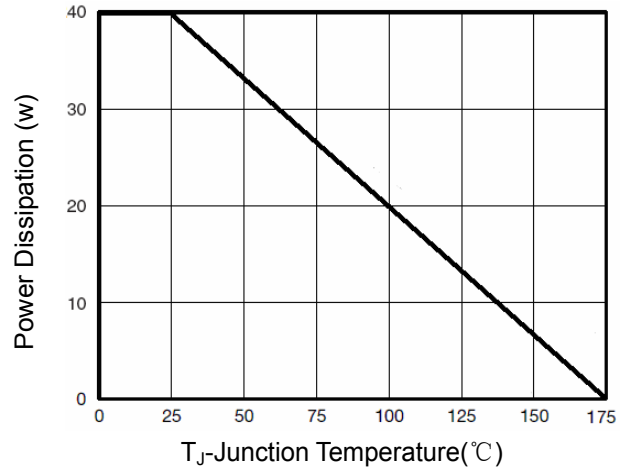
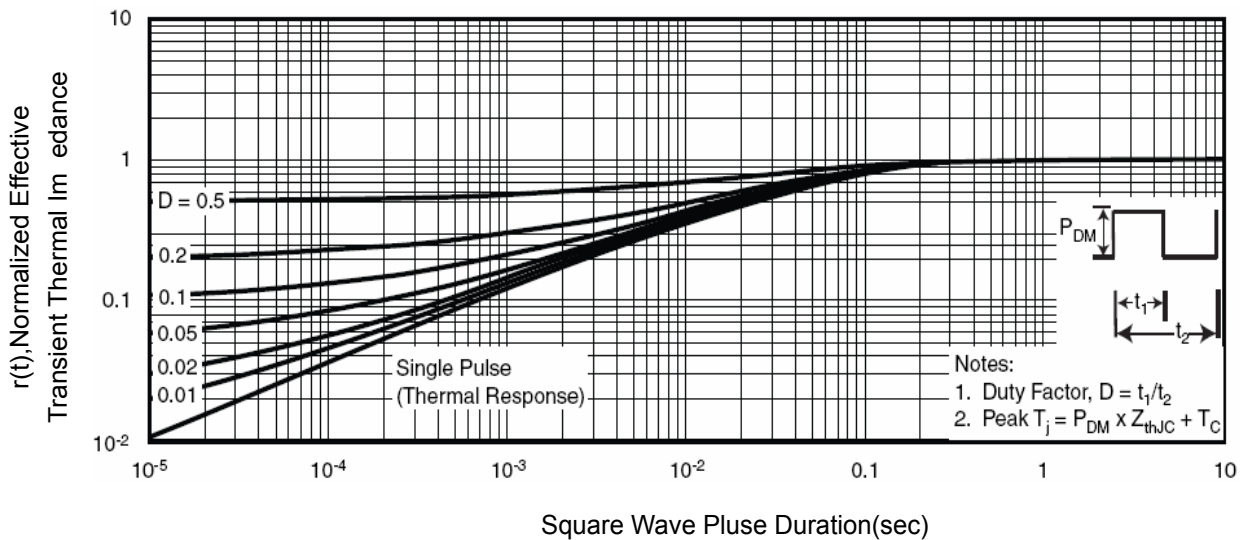
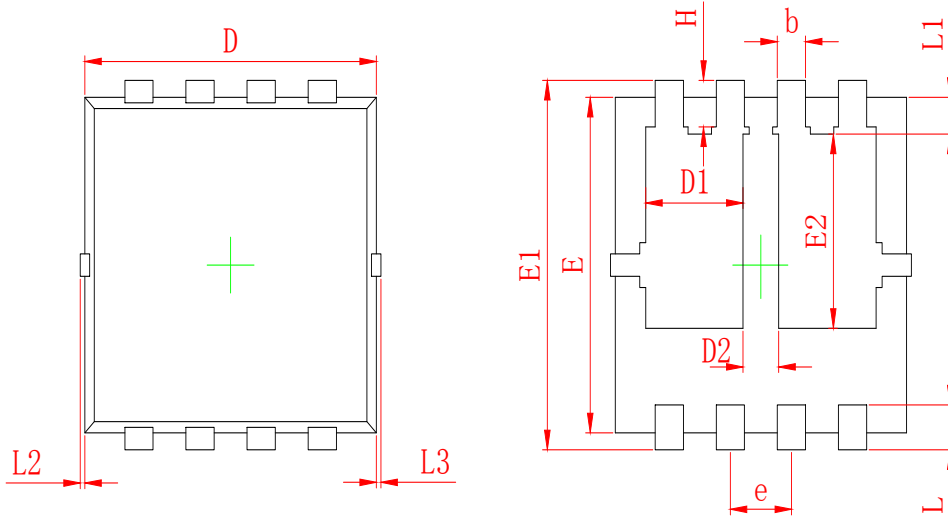
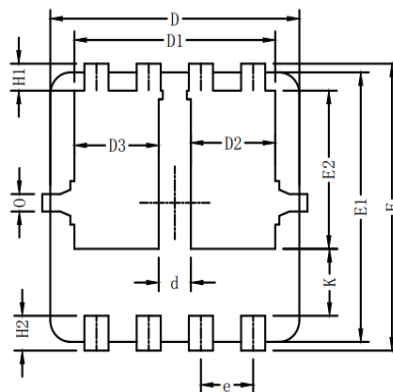
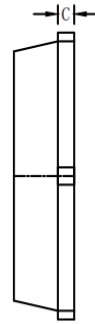
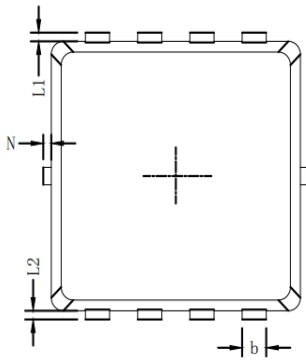
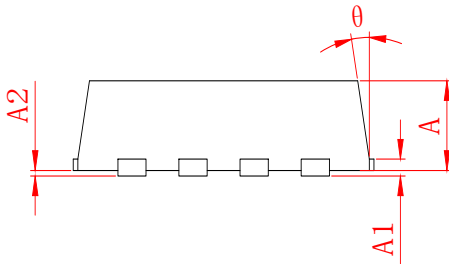

Figure 6 Source- Drain Diode Forward

P- Channel 100V MOSFET

Figure 7 Capacitance vs Vds

Figure 9 Drain Current vs Case Temperature

Figure 8 Safe Operation Area

Figure 10 Power De-rating

Figure 11 Normalized Maximum Transient Thermal Impedance

●Dimensions (PDFN3.3×3.3)

SYMBOL	MILLIMETER	
	MIN	MAX
A	0.700	0.900
A1	0.152 REF.	
A2	0°0.05	
D	3.000	3.200
D1	0.935	1.135
D2	0.280	0.480
E	2.900	3.100
E1	3.150	3.450
E2	1.535	1.935
b	0.200	0.400
e	0.550	0.750
L	0.300	0.500
L1	0.180	0.480
L2	0°0.100	
L3	0°0.100	
H	0.315	0.515
θ	8°	12°



Symbols	Millimeters		
	MIN.	NOM.	MAX.
A	0.65	0.75	0.85
b	0.25	0.30	0.35
c	0.15	0.20	0.25
D	3.00	3.10	3.20
D1	2.40	2.50	2.60
D2/D3	1.00	1.05	1.10
d	0.30	0.40	0.50
E	3.20	3.30	3.40
E1	3.00	3.10	3.20
E2	1.72	1.82	1.92
e	0.65 BSC.		
H1	0.21	0.31	0.41
H2	0.30	0.40	0.50
K	0.67	0.77	0.87
L1/L2	0.10 REF.		
θ	11°	12°	13°
N	0	-	0.15
0	0.2 REF.		

Disclaimer:

The information provided in this document is believed to be accurate and reliable. however, Shenzhen Core Control Electronics Technology Co., Ltd. does not assume any responsibility for the following consequences. Do not consider the use of such information or use beyond its scope.

The information mentioned in this document may be changed at any time without notice.

The products and information provided in this document do not infringe patents. Shenzhen Core Control Electronics Technology Co., Ltd. assumes no responsibility for any infringement of any other rights of third parties. The result of using such products and information.

This document is the second version issued on May 10th, 2023. This document replaces all previously provided information.

 It is a registered trademark of Shenzhen Core Control Electronics Technology Co., Ltd.

Copyright © 2017 Shenzhen Core Control Electronics Technology Co., Ltd. all rights reserved.