



Product: [RSWP 4-RKP 4-803](#)

Mini Power Double-Ended Cordset: 1 3/8" female angled to 1 3/8" female straight, 4-pin(3+PE), black body, 600 V, 40 A; TPE black cable, 10 AWG

Product Description

Mini Power Double-Ended Cordset: 1 3/8" female angled to 1 3/8" female straight, 4-pin(3+PE), black body, 600 V, 40 A; TPE black cable, 10 AWG

Technical Drawing

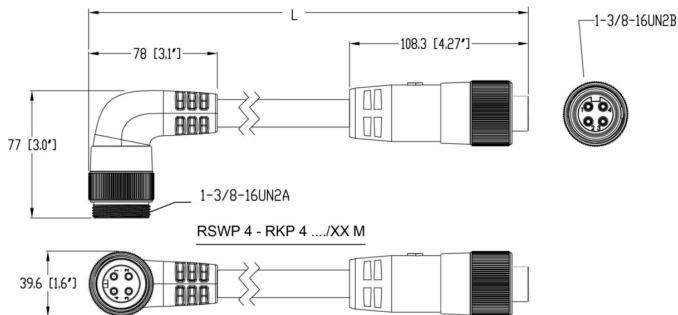

Technical Specifications

Product Description

Product Family:	Power Connector
Brand:	Lumberg Automation
Connector Type:	Cordset, double ended
Shielding:	Unshielded
Rated Voltage (UL):	600 V
Rated Current (UL)*:	40 A

Technical Data Side 1

Product Sub Family:	1 3/8"
Type of Contact / Gender:	male
Connector Design:	angled
Attachment Type:	Coupling Nut
Number of Pins:	4(3+PE)
Ambient Temperature (Operation)*:	-30 °C to +90 °C
Protection Degree / IP Rating**:	IP 67, IP 68
Contact Base Material:	CuSn
Contact Plating:	Ni/Au
Contact Bearer Material:	PVC
Contact Bearer Color:	black
Molded Body Material:	PVC
Molded Body Color:	black
Attachment Material:	CuZn

Cable Data

Cable Number:	803
---------------	-----

Conductor Size:	10 AWG
Number of Wires:	4
Cable Jacket Material:	TPE
Cable Jacket Color:	black
Cable Diameter D:	ø 0.519"
Wire Insulation Material:	PVC/NYLON
Ambient Temperature (Fixed Installation):	-30 °C to +90 °
Flammability Class (Cable Jacket):	FT-4

Technical Data Side 2

Product Sub Family, Side 2:	1 3/8"
Type of Contact / Gender, Side 2:	female
Connector Design, Side 2:	straight
Attachment Type, Side 2:	Coupling Nut
Number of Pins, Side 2:	4(3+PE)
Ambient Temperature (Operation), Side 2*:	-30 °C to +90 °C
Protection Degree / IP Rating, Side 2**:	IP 67, IP 68
Contact Base Material, Side 2:	CuSn
Contact Plating, Side 2:	Ni/Au
Contact Bearer Material, Side 2:	PVC
Contact Bearer Color, Side 2:	black
Molded Body Material, Side 2:	PVC
Molded Body Color, Side 2:	black
Attachment Material, Side 2:	CuZn

Approvals

UL-File:	E482233
UL:	TC-ER

Safety & Environmental Compliance

RoHS Compliant:	Yes
-----------------	-----

Resistances

Oil Resistance:	Oil Res I/II
UV Resistance:	Sunlight Res

Notes

Protection Degree / IP Rating Note:	** only if mounted and locked in combination with Hirschmann / Lumberg Automation connector.
-------------------------------------	--

Variants

Item #	Item Description	Cable Length
511000050	RSWP 4-RKP 4-803/0.5M	0.5 m
511000051	RSWP 4-RKP 4-803/1M	1 m
511000053	RSWP 4-RKP 4-803/2M	2 m
511000055	RSWP 4-RKP 4-803/3M	3 m
511000056	RSWP 4-RKP 4-803/4M	4 m
511000057	RSWP 4-RKP 4-803/5M	5 m
511000058	RSWP 4-RKP 4-803/6M	6 m
511000059	RSWP 4-RKP 4-803/8M	8 m
511000060	RSWP 4-RKP 4-803/10M	10 m
511000061	RSWP 4-RKP 4-803/12M	12 m
511000062	RSWP 4-RKP 4-803/14M	14 m
511000063	RSWP 4-RKP 4-803/15M	15 m
511000064	RSWP 4-RKP 4-803/18M	18 m
511000065	RSWP 4-RKP 4-803/20M	20 m
511000066	RSWP 4-RKP 4-803/22M	22 m
511000067	RSWP 4-RKP 4-803/25M	25 m
511000068	RSWP 4-RKP 4-803/30M	30 m
511000069	RSWP 4-RKP 4-803/35M	35 m
511000070	RSWP 4-RKP 4-803/40M	40 m

511000071	RSWP 4-RKP 4-803/45M	45 m
511000072	RSWP 4-RKP 4-803/50M	50 m
511000052	RSWP 4-RKP 4-803/1.5M	1.5 m
511000054	RSWP 4-RKP 4-803/2.5M	2.5 m

© 2023 Belden, Inc

All Rights Reserved.

Although Belden makes every reasonable effort to ensure their accuracy at the time of this publication, information and specifications described here in are subject to error or omission and to change without notice, and the listing of such information and specifications does not ensure product availability.

Belden provides the information and specifications herein on an "ASIS" basis, with no representations or warranties, whether express, statutory or implied. In no event will Belden be liable for any damages (including consequential, indirect, incidental, special, punitive, or exemplary damages) whatsoever, even if Belden has been advised of the possibility of such damages, whether in an action under contract, negligence or any other theory, arising out of or in connection with the use, or inability to use, the information or specifications described herein.

All sales of Belden products are subject to Belden's standard terms and conditions of sale.

Belden believes this product to be in compliance with all applicable environmental programs as listed in the data sheet. The information provided is correct to the best of Belden's knowledge, information and belief at the date of its publication. This information is designed only as a general guide for the safe handling, storage, and any other operation of the product itself or the one that it becomes a part of. The Product Disclosure is not to be considered a warranty or quality specification. Regulatory information is for guidance purposes only. Product users are responsible for determining the applicability of legislation and regulations based on their individual usage of the product.