

CONTENTS 索引

1 Product Search 產品搜索

■ Series Table	產品系列表	P2~4
■ Series Chart	產品體系圖	P5~7

2 User Guide 用戶指南

■ General Information for Applications	鋁電解電容器使用注意事項	P8~13
■ Explanation of Part Numbers	產品編碼規則	P14~16
■ Taping & Packaging Specifications (Chip Type)	編帶與包裝標準 (貼片式)	P17, 18
■ Taping Specifications (Radial Lead Type)	編帶標準 (引線式)	P19
■ Packaging Specifications (Radial Lead & Snap-in Terminal Type)	包裝標準 (引線式及導箔式)	P20
■ Lead Forming & Cutting (Radial Lead Type)	引線成型與剪腳 (引線式)	P21
■ Soldering Conditions & Recommended Land Size on PC Board (Chip Type)	焊接條件及推薦安裝尺寸 (貼片式)	P22, 23
■ Life Time Estimation of Capacitors	電容器的壽命時間推算	P24
■ Basic Construction of Aluminum Electrolytic Capacitors	鋁電解電容器的基本結構	P25
■ Corresponding to RoHS Directive	對應 RoHS 指令	P26
■ Eco-friendly Products	親環境產品	P27
■ Compliance for EU REACH Regulation	遵循歐盟 REACH 法規	P27
■ Case Sizes & Weight Range	產品尺寸與重量	P28

3 Product Specifications 產品規格說明

■ Conductive Polymer Aluminum Solid Electrolytic Capacitors (Chip & Radial Lead Type)	導電性高分子固態鋁電解電容器 (引線式及貼片式)	P29~60
■ Conductive Polymer Hybrid Aluminum Electrolytic Capacitors (Chip & Radial Lead Type)	導電性高分子混合型鋁電解電容器 (引線式及貼片式)	P61~75
■ Aluminum Electrolytic Capacitors (Chip Type)	鋁電解電容器 (貼片式)	P76~113
■ Aluminum Electrolytic Capacitors (Radial Lead Type)	鋁電解電容器 (引線式)	P114~169
■ Aluminum Electrolytic Capacitors (Snap-in Terminal Type)	鋁電解電容器 (導箔式)	P170~187



Caution for safety 安全注意事項



- To use Fujicon product correctly and safety, please read "General Information for Application" very carefully.
- The products are designed and manufactured chiefly for general electronic appliances. In case that you are going to apply them for medical equipment, aircraft, space equipment, or the same kind that requires high safety, you are required to confirm application through your own testing and own judgment.
- All design and specifications in this catalogue are for reference only. If any doubt about safety for your application, please contact us immediately for technical assistance before purchase.
- 為了正確安全地使用產品，請在使用前仔細閱讀“鋁電解電容器使用注意事項”；
- 本產品目錄中所登載的產品是為一般電子設備用而設計和製造的，如果要用於醫療設備、宇航設備等需要高度安全性的設備，必須事先對適合性做充分的測試；
- 本產品目錄中所提供的設計及特性參數僅供參考。如果在使用上有疑問，請在採購前與我們聯繫，以便提供技術上的協助。

SERIES TABLE 產品系列表

■ Conductive Polymer Aluminum Solid Electrolytic Capacitors (Chip Type) 導電性高分子固態鋁電解電容器 (貼片式) 

Type 類型	Series 系列	Features 特性	Standard Type 標準型	Low ESR 低阻抗	Long Life 長壽命	High Temperature 高溫	Category Temperature Range (°C) 使用溫度範圍	Rate Voltage Range (V.D.C.) 額定工作電壓範圍	Capacitance Range (µF) 靜電容量範圍	Endurance (Hours) 耐久性 (小時)	Page 頁碼	
Chip Type 貼片式	Standard 標準型	MA	Standard, Low ESR 標準低阻抗品	●	●		-55~+105	2.5~25	3.3~1500	2000	30	
	High Capacitance 大容量型	MB	High Capacitance, Ultra-low ESR 大容量, 極低阻抗品		●		-55~+105	2.5~18	56~2200	2000	33	
	125°C High Temperature 高溫型	MR	125°C High Temperature, High Reliability 125°C高溫, 高可靠品		●	●	-55~+125	16~50	5.6~390	1500~3000	36	
	Long Life 長壽命型	MS	Long Life Assurance 長壽命品		●	●		-55~+105	4~50	22~560	5000	39
		MX	Ultra Long Life Assurance 超長壽命品		●	●		-55~+105	4~16	22~560	20000	41
High Voltage/ Long Life 高壓長壽命型	MV	High Voltage, Long Life Assurance 高壓長壽命品		●	●		-55~+105	16~125	5.6~680	3000	43	

■ Conductive Polymer Aluminum Solid Electrolytic Capacitors (Radial Lead Type) 導電性高分子固態鋁電解電容器 (引線式) 

Type 類型	Series 系列	Features 特性	Standard Type 標準型	Low ESR 低阻抗	Long Life 長壽命	High Temperature 高溫	Category Temperature Range (°C) 使用溫度範圍	Rate Voltage Range (V.D.C.) 額定工作電壓範圍	Capacitance Range (µF) 靜電容量範圍	Endurance (Hours) 耐久性 (小時)	Page 頁碼	
Radial Lead Type 引線式	Standard 標準型	PA	Standard, Low ESR 標準低阻抗品	●	●		-55~+105	2.5~25	6.8~1500	2000	46	
	High Capacitance 大容量型	PB	High Capacitance, Ultra-low ESR 大容量, 極低阻抗品		●		-55~+105	2.5~16	270~2200	2000	49	
	125°C High Temperature 高溫型	PR	125°C High Temperature, High Reliability 125°C高溫, 高可靠品		●	●	-55~+125	16~50	22~100	3000	52	
	Long Life 長壽命型	PS	Long Life Assurance 長壽命品		●	●		-55~+105	2.5~16	100~1500	5000	54
		PX	Ultra Long Life Assurance 超長壽命品		●	●		-55~+105	4~16	6.8~2200	20000	56
High Voltage/ Long Life 高壓長壽命型	PV	High Voltage, Long Life Assurance 高壓長壽命品		●	●		-55~+105	16~100	6.8~2700	3000	58	

■ Conductive Polymer Hybrid Aluminum Electrolytic Capacitors (Chip Type) 導電性高分子混合型鋁電解電容器 (貼片式) 

Type 類型	Series 系列	Features 特性	Standard Type 標準型	Low ESR 低阻抗	Long Life 長壽命	High Temperature 高溫	Category Temperature Range (°C) 使用溫度範圍	Rate Voltage Range (V.D.C.) 額定工作電壓範圍	Capacitance Range (µF) 靜電容量範圍	Endurance (Hours) 耐久性 (小時)	Page 頁碼
Chip Type 貼片式	Long Life 長壽命型	HMB	Long Life Assurance 長壽命品	●	●	●	-55~+105	16~100	22~1500	5000	62
	125°C High Temperature 高溫型	HMR	125°C High Temperature, High Reliability 125°C高溫, 高可靠品		●	●	-55~+125	16~100	22~1500	4000	65
	Ultra Long Life 超長壽命型	New HMX	Ultra Long Life Assurance 超長壽命品		●	●		-55~+105	25~80	10~330	10000

■ Conductive Polymer Hybrid Aluminum Electrolytic Capacitors (Radial Lead Type) 導電性高分子混合型鋁電解電容器 (引線式) 

Type 類型	Series 系列	Features 特性	Standard Type 標準型	Low ESR 低阻抗	Long Life 長壽命	High Temperature 高溫	Category Temperature Range (°C) 使用溫度範圍	Rate Voltage Range (V.D.C.) 額定工作電壓範圍	Capacitance Range (µF) 靜電容量範圍	Endurance (Hours) 耐久性 (小時)	Page 頁碼
Radial Lead Type 引線式	Long Life 長壽命型	HPB	Long Life Assurance 長壽命品	●	●	●	-55~+105	16~100	47~1500	5000	70
	125°C High Temperature 高溫型	HPR	125°C High Temperature, High Reliability 125°C高溫, 高可靠品		●	●	-55~+125	16~100	22~1500	4000	72
	Ultra Long Life 超長壽命型	New HPX	Ultra Long Life Assurance 超長壽命品		●	●		-55~+105	25~80	22~330	10000

→ Continue to next page 續下一頁

→Continued from previous page 續上一頁

■ Aluminum Electrolytic Capacitors (Chip Type) 鋁電解電容器 (貼片式) 

Type 類型	Series 系列	Features 特性	Standard Type 標準型	Miniature 超小型	Low Impedance 低阻抗	Long Life 長壽命	Category Temperature Range (°C) 使用溫度範圍	Rate Voltage Range (V.D.C.) 額定工作電壓範圍	Capacitance Range (μF) 靜電容量範圍	Endurance (Hours) 耐久性 (小時)	Page 頁碼	
Chip Type 貼片式	General Purpose 普通型	CS	Standard 標準品	●			-55~+85	4~450	0.1~10000	2000	77	
		CK	Standard, wide temperature range 寬溫標準品	●			-55~+105	4~450	0.1~8200	2000	80	
	Low Leakage Current 低漏電流型	SC	Low leakage current 低漏電流品	●			-55~+85	6.3~50	0.1~220	2000	83	
	Non-polarized 無極性型	CN	Non-polarized 無極性品	●			-55~+85	6.3~50	0.1~100	1000	85	
		KP	Non-polarized, wide temperature range 無極性寬溫品	●			-55~+105	6.3~50	0.1~47	1000	87	
	Low Impedance 低阻抗型	LZ	Low impedance 低阻抗品			●	-55~+105	6.3~100	1~4700	2000	89	
		KZ	Extra low impedance 極低阻抗品			●	-55~+105	6.3~100	4.7~4700	1000~3000	92	
	Long Life 長壽命型	FZ	Long life, extra low impedance 長壽命, 極低阻抗品			●	●	-55~+105	6.3~100	3.3~8200	2000~5000	95
		New FS	Smaller size, long life, extra low impedance 小型化, 長壽命, 極低阻抗品		●	●	●	-55~+105	6.3~50	3.3~8200	2000~5000	98
		EL	Long life assurance 寬溫長壽命品				●	-55~+105	6.3~50	0.1~3300	2000~3000	100
		KL	5000 hours load life 5000小時長壽命品				●	-55~+105	6.3~100	0.1~3300	3000~5000	102
	125°C High Temperature 高溫型	KH	125°C high temperature, high reliability 125°C高溫, 高可靠品				●	-40~+125	10~450	3.3~4700	1000~5000	105
	High Voltage/ Long Life 高壓長壽命型	CP	High voltage, 3000 hours load life 3000小時, 高壓長壽命品				●	-55~+85	160~450	3.3~100	3000	108
		CH	High voltage, 3000 hours load life 3000小時, 高壓長壽命品				●	-55~+105	160~450	3.3~100	3000	110
		HU	High voltage, 5000 hours load life 5000小時, 高壓長壽命品				●	-40~+105	160~450	3.3~47	5000	112

■ Aluminum Electrolytic Capacitors (Radial Lead Type) 鋁電解電容器 (引線式) 

Radial Lead Type 引線式	General Purpose 普通型	RA	For general purpose, standard size 標準品	●			-40~+85	6.3~100	0.1~22000	2000	115
			-25~+85	160~450	0.47~680						
		RK	Standard size, wide temperature range 寬溫標準品	●			-40~+105	6.3~100	0.47~15000	2000	117
			-25~+105	160~450	0.47~330						
		New KT	Lower category temperature, sleeveless 超低工作溫度, 無膠管			●	-55~+105	4~100	0.1~8200	2000	119
		RE	Standard size, wide temperature range 寬溫標準品	●		●	-40~+105	6.3~100	0.47~15000	3000	122
	-25~+105		160~450	1~470							
	RM	Height 7(9)mm, wide temperature range 7(9)mm高, 寬溫品		●		-40~+105	4~63	0.1~1000	1000	124	
	RS	Height 5mm, wide temperature range 5mm高, 寬溫品		●		-40~+105	4~63	0.1~470	1000	126	
	Low Leakage Current 低漏電流型	LA	Low leakage current, standard size 低漏電流標準品	●			-40~+85	10~100	1~4700	2000	128
		LK	Low leakage current, standard size, wide temperature range 低漏電流寬溫品	●			-40~+105	10~50	0.47~330	1000	130
		LM	Low leakage current, height 7mm 7mm高, 低漏電流品		●		-40~+105	6.3~63	0.1~220	1000	132
LS		Low leakage current, height 5mm 5mm高, 低漏電流品		●		-40~+105	4~50	0.1~100	1000	134	

→Continue to next page 續下一頁

→Continued from previous page 續上一頁

Type 類型	Series 系列	Features 特性	Standard Type 標準型	Miniature 超小型	Low Impedance 低阻抗	Long Life 長壽命	Category Temperature Range (°C) 使用溫度 範圍	Rate Voltage Range (V.D.C.) 額定工作 電壓範圍	Capacitance Range (μF) 靜電容量 範圍	Endurance (Hours) 耐久性 (小時)	Page 頁碼		
Radial Lead Type 引線式	Non-polarized 無極性型	NP	Non-polarized, standard size 無極性標準品	●			-40~+85	6.3~250	0.47~10000	2000	136		
		NK	Non-polarized, standard size, wide temperature range 無極性寬溫標準品	●			-40~+105	6.3~100	0.1~10000	1000	138		
		NM	Non-polarized, height 7mm 7mm高, 無極性品		●			-40~+105	6.3~63	0.1~220	1000	140	
		NS	Non-polarized, height 5mm 5mm高, 無極性品		●			-40~+105	6.3~50	0.1~47	1000	142	
		BP	For horizontal deflection circuit, bi-polarized 水平偏轉電路專用, 雙極性品	●				-40~+85	25~50	2.2~10	1000	144	
		BH	For horizontal deflection circuit, bi-polarized, wide temperature range 水平偏轉電路專用, 雙極性寬溫品	●				-40~+105	25~50	2.2~10	1000	145	
	Low Impedance 低阻抗型	TM		Low impedance, standard 低阻抗標準品	●		●	-40~+105	6.3~100	1~15000	2000~3000	146	
							●	-25~+105	160~450	22~330		146	
		TN		Extremely low impedance, high reliability 極低阻抗, 高可靠品			●	●	-40~+105	6.3~100	1~15000	2000~5000	150
							●	-25~+105	160~450	22~330	150		
	RZ	New	Lower category temperature, extremely low impedance, sleeveless 超低工作溫度, 極低阻抗, 無膠管			●	●	-55~+105	6.3~100	3.3~8200	2000~5000	153	
	TL		Extremely low impedance, long life 極低阻抗, 長壽命品			●	●	-40~+105	6.3~100	0.47~18000	4000~10000	156	
	125°C High Temperature 高溫型	TW		High temperature range for 125°C use 125°C高溫品			●	-40~+125	6.3~250	0.47~15000	2000	159	
	High Reliability 高可靠型	TY		High frequency, high ripple current, low impedance & long life 高頻, 高紋波電流, 低阻抗長壽命品			●	●	-40~+105	6.3~50	47~18000	2000~7000	162
		TB		For electronic ballast, power supply & LED lighting 電子鎮流器、電源和LED照明專用品			●	●	-25~+105	160~450	2.2~100	2000~5000	164
		TX		Long life, for electronic ballast, power supply & LED lighting 長壽命, 電子鎮流器、電源和LED照明專用品			●	●	-25~+105	160~450	2.2~330	5000~10000	166
PL			High ripple current, for SMPS 高紋波電流, 開關式電源專用品			●	●	-25~+105	400	33~150	5000	168	
					●	-40~+105	450	33~150					

Aluminum Electrolytic Capacitors (Snap-in Terminal Type) 鋁電解電容器(導箔式) 

Type 類型	Series 系列	Features 特性	Standard Type 標準型	Miniature 超小型	Low Impedance 低阻抗	Long Life 長壽命	Category Temperature Range (°C) 使用溫度 範圍	Rate Voltage Range (V.D.C.) 額定工作 電壓範圍	Capacitance Range (μF) 靜電容量 範圍	Endurance (Hours) 耐久性 (小時)	Page 頁碼	
Snap-in Terminal Type 導箔式	General Purpose 普通型	SM	Snap-in terminal, standard 導箔型, 標準品	●			-40~+85	6.3~350	82~10000	2000	171	
							-25~+85	400~450	68~560			
	SK	Snap-in terminal, wide temperature range 導箔型, 寬溫品	●				-40~+105	6.3~350	68~68000	2000	174	
							-25~+105	400~450	56~470			
	High Reliability 高可靠型	SP	Snap-in terminal, long life 導箔型, 長壽命品				●	-40~+85	16~350	82~68000	3000	177
							●	-25~+85	400~450	56~560		
	SH	Snap-in terminal, wide temperature range, long life 導箔型, 寬溫, 長壽命品					●	-40~+105	16~350	100~22000	3000	181
							●	-25~+105	400~450	100~680		
Low Impedance 低阻抗型	ST	Snap-in terminal, low impedance, long life 導箔型, 低阻抗, 長壽命品				●	-40~+105	16~100	220~22000	3000~5000	184	
						●	-25~+105	160~450	68~4700			

● Note: Please read "General Information for Application" very carefully before using these products.
●注: 在使用這些產品前請仔細閱讀“鋁電解電容器使用注意事項”。

SERIES CHART 產品體系圖

Conductive Polymer Aluminum Solid Electrolytic Capacitors (Chip Type) 導電性高分子固態鋁電解電容器 (貼片式)

() Page number 頁碼

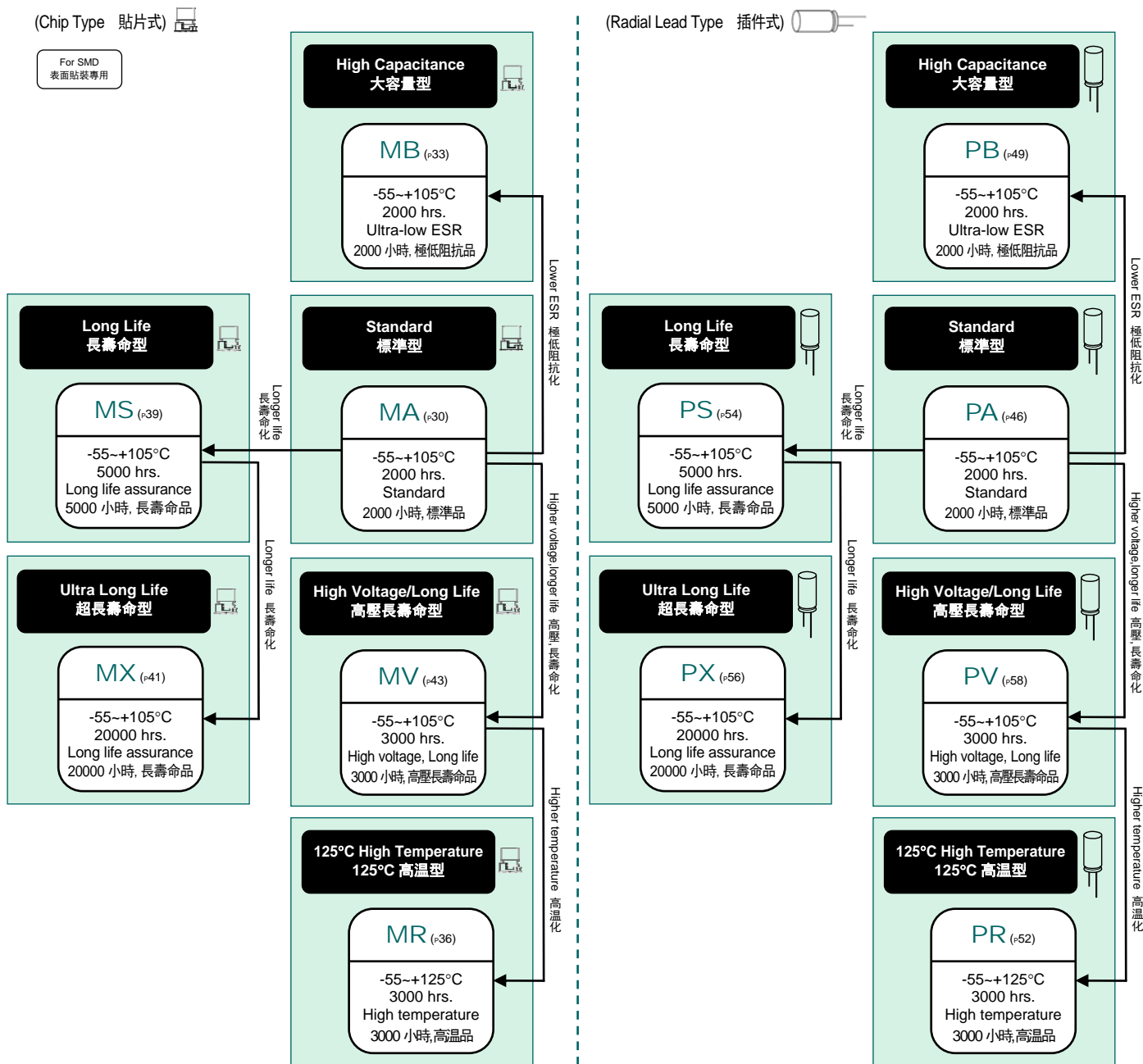

Conductive Polymer Hybrid Electrolytic Capacitors 導電性高分子混合型鋁電解電容器

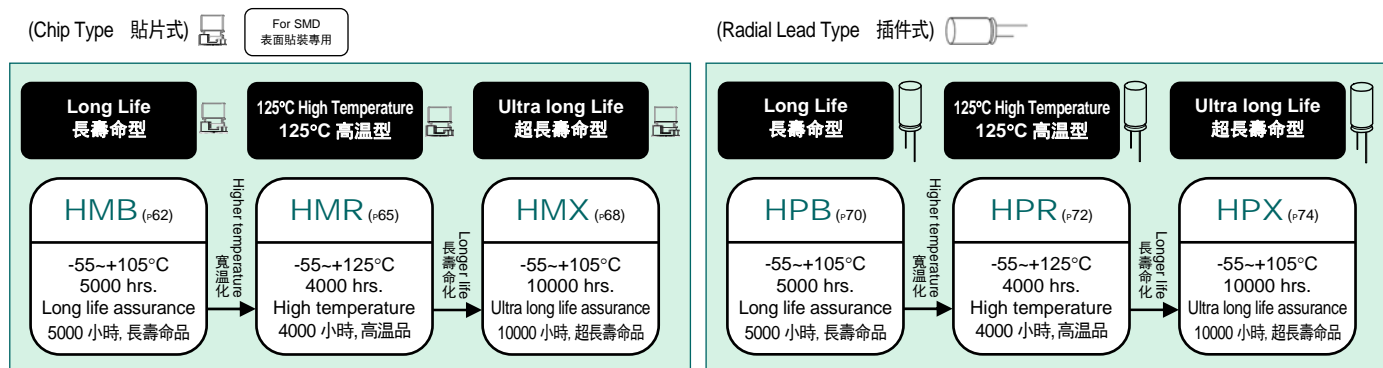

● Note: Please read "General Information for Application" very carefully before using these products.

●注: 在使用這些產品前請仔細閱讀“鋁電解電容器使用注意事項”。

SERIES CHART 產品體系圖

Aluminum Electrolytic Capacitors (Chip Type) 鋁電解電容器 (貼片式)

For SMD
表面貼裝專用

() Page number 頁碼

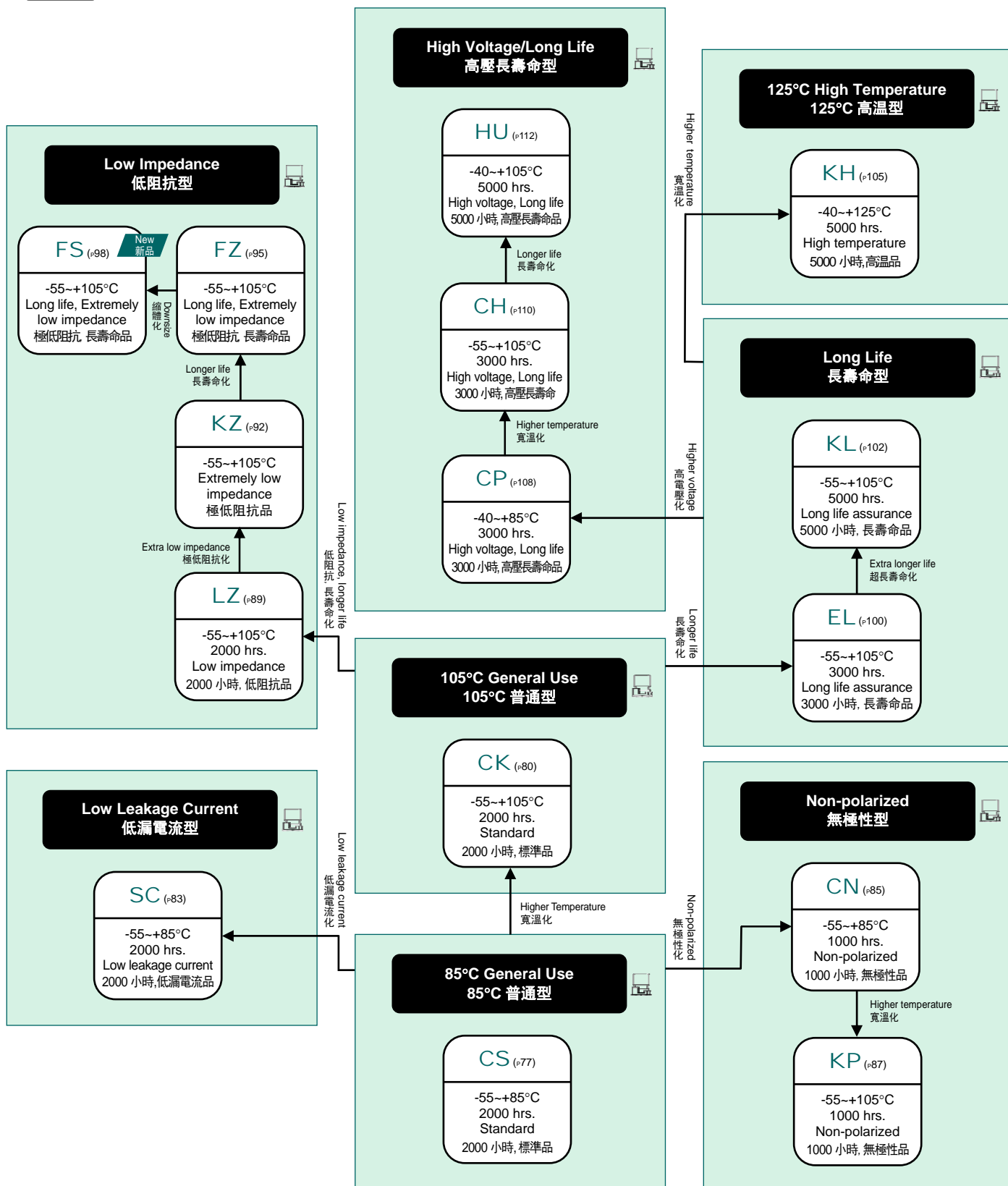

● Note: Please read "General Information for Application" very carefully before using these products.
●注: 在使用這些產品前請仔細閱讀“鋁電解電容器使用注意事項”。

SERIES CHART 產品體系圖

Aluminum Electrolytic Capacitors (Radial Lead & Snap-in Terminal Type) 鋁電解電容器 (引線式及導箔式)



() Page number 頁碼

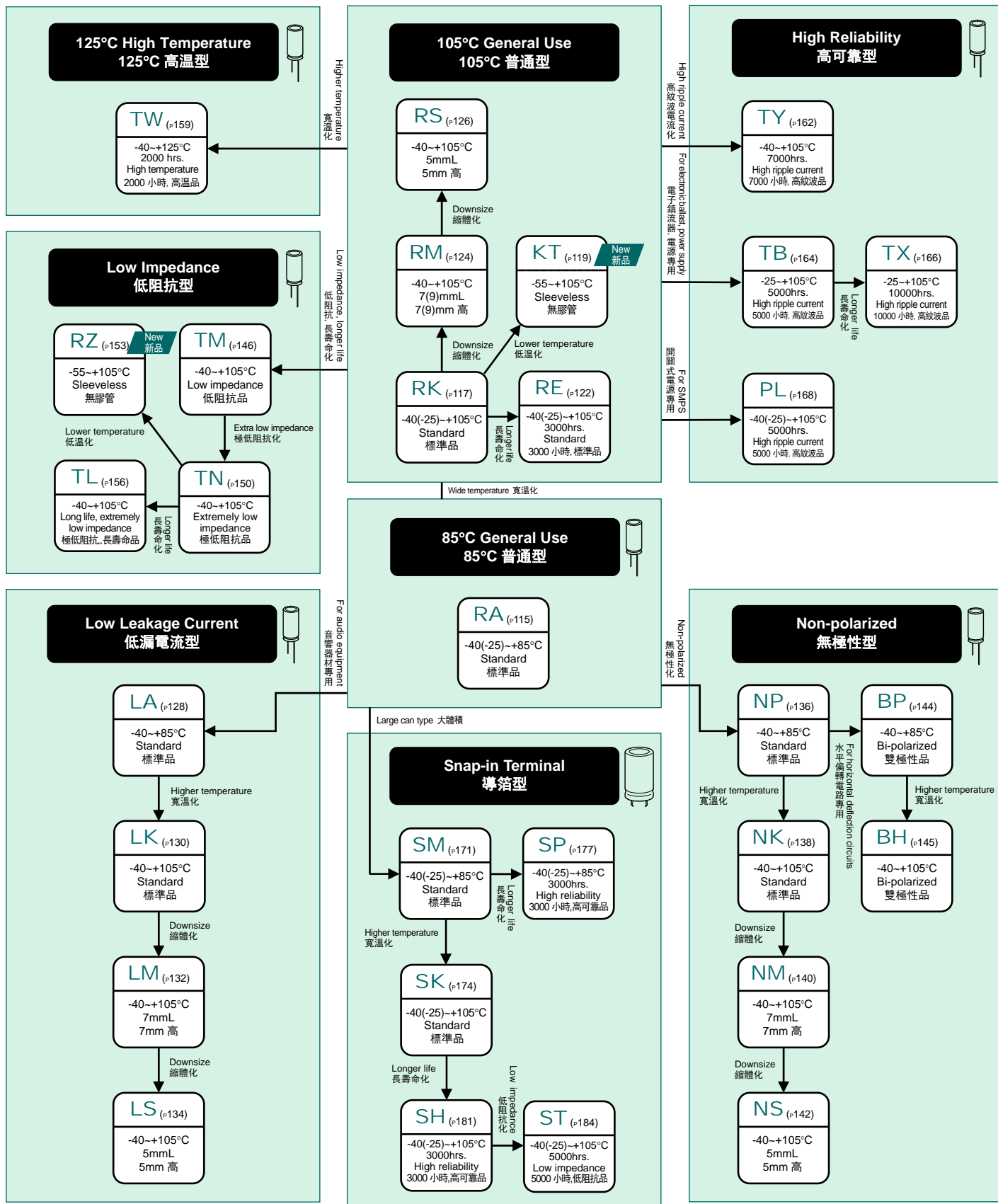

● Note: Please read "General Information for Application" very carefully before using these products.
 ●注：在使用這些產品前請仔細閱讀“鋁電解電容器使用注意事項”。

⚠ GENERAL INFORMATION FOR APPLICATION

The following precautions must be observed when using electrolytic capacitors.

1. Circuit Design

- 1) Please make sure that the environmental and mounting conditions to which the capacitor to be exposed are within the conditions specified in this catalogue.
- 2) Operating temperature and applied ripple must be within the specifications.
 - ① The capacitor shall not be used in an ambient temperature which exceeds the operating temperature specified in the specification.
 - ② Do not apply excessive current which exceeds the allowable ripple current.
- 3) Appropriate capacitors which comply with the life requirement of the products, should be selected when designing the circuit.
- 4) Aluminum electrolytic capacitors are polarized. Make sure that no reserve voltage or AC voltage is applied to the capacitors. Please use non-polarized capacitors for a circuit that can possibly see reserved polarity.
 Note: Even non-polarizes capacitors cannot be used for AC voltage application.
- 5) For a circuit that repeats rapid charging/discharging of electricity, an appropriate capacitor that is capable of enduring such a condition must be used. Welding machines and photo flash are a few examples of products that contain such a circuit. In addition, rapid charging/discharging may be repeated in control circuits for servomotors, In which the circuit voltage fluctuates substantially. For appropriate choice of capacitors for circuit that repeat rapid charging/discharging, please consult us. If excess a rush current due to drastic charge/dis-charge was applied to conductive polymer aluminum solid electrolytic capacitors, and conductive polymer hybrid aluminum electrolytic capacitors, it may cause a short circuit or an increase in leakage current. Therefore, Please do not apply a rush current that is larger than 10A.
- 6) Make sure that no excess voltage (that is higher than the rated voltage) is applied to the capacitor.
 - ① Pleased pay attention so that the peak voltage, which is DC voltage overlapped by ripple current, should not exceed the rated voltage.
 - ② In the case where more than two aluminum electrolytic capacitors are used in series, please make sure that applied voltage should be lower than rated voltage should be applied to each capacitor equally using a balancing resistor in parallel with the capacitor.
 Please do not use conductive polymer aluminum solid electrolytic capacitors, and conductive polymer hybrid aluminum electrolytic capacitors for the application listed below, since the solid organic polymer aluminum electrolytic capacitors cannot reach it's maximum performance.
 - a) Coupling circuits.
 - b) R-C timing circuit.
 - c) High impedance voltage retention circuit.
 - d) Circuits, which extremely low voltage in compared to the rated voltage is only applied.
 - e) Circuits, which are greatly affected by leakage currents for special use such as multiple parts used in a series, please contact us for recommendations.
- 7) Outer sleeved of the capacitor is not guarantee as an electrical insulator. Do not use standard sleeve on a capacitor in applications that require electrical insulation. When the application requires special insulation, please contact our sales office for details.
- 8) Capacitors may fail if they are used under the following conditions:
 - ① Environmental (climatic) conditions
 - a) Being exposed to water, high temperature & high humidity atmosphere, or condensation of moisture.
 - b) Being exposed to oil or an atmosphere that is filled with particles of oil.
 - c) Being exposed to salty water or an atmosphere that is filled with particles of salt.
 - d) In an atmosphere filled with toxic gasses (such as hydrogen sulfide, sulfurous acid, nitrous acid, chlorine, bromine, methyl bromide, ammonia, etc.).
 - e) Being exposed to direct sunlight, ozone, ultraviolet ray, or radiation.
 - f) Being exposed to acidic or alkaline solutions.
 - ② Severe vibration and physical shock conditions that exceed our specification.
 Vibration test condition:
 - Vibration frequency range: 10~55~10Hz
 - Sweet rate: 10~55~10Hz per minute
 - Sweet method: logarithmic
 - Amplitude or acceleration: 1.5mm (maximum acceleration is 10G)
 - Direction of vibration: X, Y, Z direction
 - Testing time: 2 hours per each direction
 Shock is not applicable normally.
 If a particular condition is required, please contact our sales office.
- 9) When designing a circuit board, please pay attention to the following:
 - ① Have the hole spacing on the P.C. board match the lead spacing of the capacitor.
 - ② There should not be any circuit pattern or circuit wire above the capacitor safety vent.
 - ③ Unless otherwise specified, following clearance should be made above the pressure relief vent.

Case Diameter	Clearance Required
∅6.3 to 16	2mm or more
∅18 to 35	3mm or more
∅40 or more	5mm or more
 - ④ In case the vent side is placed toward P.C. board (such as end seal vented parts), make a corresponding hole on the P.C. board to release the gas when vent is operated. The hole should be made to match the capacitor vent position.
- 10) The main chemical solution of the electrolyte and the separator paper used in the capacitors are combustible. The electrolyte is conductive. When it comes in contact with the P.C. board, there is a possibility of pattern corrosion or short circuit between the circuit

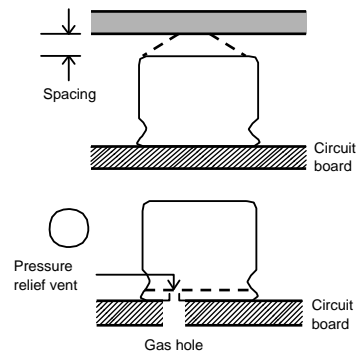

pattern which could result in smoking or catching fire. Do not locate any circuit pattern beneath the capacitor end seal.

- 11) Do not design a circuit board so that heat generating components are placed near an aluminum electrolytic capacitor or reserve side of P.C. board (under the capacitor).
- 12) Please refer to the recommended land size in this catalogue when you design in surface mount capacitors.
- 13) Electrical characteristics may vary depending on changes in temperature and frequency. Please consider the variation when you design circuits.
- 14) When you install more than 2 capacitors in parallel, consider the balance of current flowing through the capacitors. Especially, When a solid conductive polymer aluminum electrolytic capacitors, conductive polymer hybrid aluminum electrolytic capacitors and a standard aluminum electrolytic capacitors are connected in parallel, special consideration must be given.
- 15) While mounting capacitors on double side P.C. board, the capacitors should be away from those unnecessary base plate holes and connection holes.

2. Mounting

- 1) Once a capacitor has been assembled in the set and power applied, do not attempt to re-use the capacitor in other circuits or application.
- 2) Electric potential between positive and negative terminal may exist as a result of returned electromotive force, so please discharge the capacitor using 1KΩ resistor.
- 3) Leakage current of the parts that have stored for more than 2 years may increase. When leakage current has increased, please perform a voltage treatment using a 1KΩ resistor.
- 4) Please confirm rating and polarity before installing capacitor on the P.C. board.
- 5) Do not drop the capacitors on the floor, nor use a capacitors that was dropped.
- 6) Be careful not to deform the capacitor during installation.
- 7) Please confirm that the lead spacing of the capacitor matches the pad spacing of the P.C. board prior to installation.
- 8) Please pay attention that the clinch force is not too strong when capacitors are placed and fixed by an automatic insertion machine.
- 9) Please pay attention to the mechanical shock to the capacitor by suction nozzle of the automatic insertion machine or automatic mounted, or by product checker, or by centering mechanism.
- 10) Hand soldering (soldering iron):
 - ① When soldering aluminum electrolytic capacitors with a soldering iron the exposure should be limited to 260°C for 10 seconds or 350°C for 3 seconds.
 - ② At no time should the soldering iron come in contact with the capacitor body. Contact with the body can cause the sleeving to crack or melt.
 - ③ If you need to remove parts which were soldered, please melt the solder enough so that stress is not applied to lead.
- 11) Flow soldering (wave solder):
 - ① Aluminum electrolytic capacitors are not to be immersed into the solder bath at anytime. To do so would result in the internal pressure within the capacitor to rise, damaging the capacitor would result.
 - ② Aluminum electrolytic capacitors are only to be mounted to the topside of the circuit board.
 - ③ The capacitor should be to a maximum solder bath temperature of 260°C for 10 seconds.
 - ④ Preheat temperature should be limited to 125°C for 30 seconds.
 - ⑤ Please avoid contact between other components and the aluminum electrolytic capacitors. This will prevent heat from these components being transmitted to the capacitors sleeve and damaging the sleeve.
- 12) Reflow soldering (SMD only):
 - ① Please follow "Soldering Conditions" in this catalogue.
 - ② When an infrared heater is used, please pay attention to the extent of heating since the absorption rate of infrared, will vary due to difference in the color and size of the capacitor.
- 13) Do not tilt lay down or twist the capacitor body after the capacitor are soldered to the P.C. board.
- 14) Do not carry the P.C. board by grasping the soldered capacitor.
- 15) Please do not allow anytime to touch the capacitor after soldering. If P.C. board are stored in stack, please make sure P.C. board or the other components do not touch the capacitor. The capacitors shall not be effected by any radiated heat from the soldered P.C. board or other components after soldering.
- 16) Cleaning:
 - ① Do not clean capacitors with halogenated cleaning agent. However, if it is necessary to clean with halogenated cleaning agent, please contact our sales office.
 - ② Recommended cleaning method:
 Applicable: Any type, any ratings.
 Cleaning agents:
 Based alcohol solvent cleaning agent: Isopropyl Alcohol
 Based water solvent cleaning agent:
 Premium alcohol solvent type: Pine Alpha ST-100S, Techno Care FRW14~17, Sanelek B-12
 Surfactant type: cleaning through 750H/750L/710M
 Alkaline saponification agent: Aqua Cleaner 210SEP

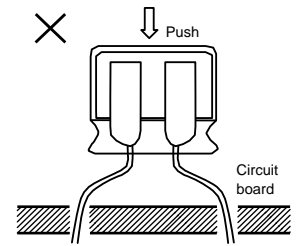

Cleaning conditions:

Total cleaning time shall be no greater than 5 minutes by immersion, ultrasonic or other method. (Temperature of the cleaning agent shall be 60°C maximum). For SMD and super miniature type, within 2 minutes total cleaning time (Temperature of agent: 40°C or below).

After the board cleaning has been completed, the capacitors should be dried using hot air for a minimum of 10 minutes. If the cleaning solution is infiltrated between the case and the sleeve, the sleeve might soften and swell when hot air temperature is too high. Therefore, hot air temperature should not exceed softening temperature (80°C) of the sleeve. Insufficient dries after water rinse may cause appearance problems, such as sleeve shrinking, bottom-plate bulging. In addition, a monitoring of the contamination of cleaning agents (electric conductivity, pH, specific gravity, water content, etc.) must be implemented.

After the cleaning, do not keep the capacitors in an atmosphere containing the cleaning agent or in an air tight container. In addition regarding jet washing, please use caution since the sleeve may expand cause of the angle and/or the strength of the water jet. Depending on the cleaning method, the marking on a capacitor may be erased or blurred.

Consult us before using a cleaning method or a cleaning agent other than those recommended.

- ③ Avoid using ozone destructive substance for cleaning agents to concern about global environment.

17) Fixing Material and Coating Material:

- ① Do not use any affixing or coating materials, which contain halide substance.
- ② Remove flux and any contamination, which remains in the gap between the end seal and P.C. board.
- ③ Please dry the cleaning agent on the P.C. board before using affixing or coating materials.
- ④ Please do not apply any material all around the end seal when using affixing or coating materials.

There are variations of cleaning agents, fixing and coating materials, so please contact those manufacture or our sales office to make sure that the material would not cause any problems.

18) Other

Wooden package material may be subjected to fumigation by a halogen (e.g. methyl bromide) before they are exported in order to protect them against pests. If devices with aluminum electrolytic capacitors or capacitors themselves are directly fumigated or packed with the pallet that is fumigated, the capacitors may internally corrode due to the halogen contents of fumigation agents.

3. In The Equipment

- 1) Do not directly touch terminal by hand.
- 2) Do not short between terminal by conductor, nor spill conductible liquid such as alkaline or acidic solution on or near the capacitor.
- 3) Please make sure that the ambient conditions where the set is installed not have any of the following conditions:
 - ① Where capacitors are exposed to water, high temperature & high humidity atmosphere, or condensation of moisture.
 - ② Where capacitors are exposed to oil or an atmosphere that is filled with particles of oil.
 - ③ Where capacitors are exposed to salty water, high temperature & high humidity atmosphere, or condensation of moisture.
 - ④ The atmosphere is filled with toxic acid gasses (e.g. hydrogen sulfide, sulfurous acid, nitrous acid, chlorine, bromine, methyl bromide, etc.).
 - ⑤ The atmosphere is filled with toxic alkaline gasses (e.g. ammonia).
 - ⑥ Where capacitors are exposed to acidic or alkaline solutions.
 - ⑦ Since shrinkage, bulging and/or crack could be seen on outer sleeve of capacitor when capacitors are used in atmosphere where condensation of moisture occurs, please confirm their adaptation before the use. The condensation of moisture could occur when temperature cycling test/rapid change of temperature test is performed, in this case, aforementioned sleeve problem could be seen.

4. Maintenance and Inspection

Please periodically inspect the aluminum capacitors that are installed in industrial equipment. The following Items should be checked:

- 1) Appearance: Remarkable abnormality such as vent operation, leaking electrolyte etc.
- 2) Electrical characteristic: Capacitance, dielectric loss tangent, leakage current etc., which are specified in this catalogue.

5. In an Emergency

- 1) If you see smoke due to operation of safety vent, turn off the main switch or pull out the plug from the outlet.
- 2) Do not draw your face to the safety vent since gas over 100°C will be emitted when the safety vent operates. If the gas has entered your eyes, please flush your eyes immediately in pure water. If you breathed the gas immediately wash out your mouth and throat with water.
- 3) Do not ingest electrolyte. If your skin is exposed to electrolyte, please wash it away using soap and water.

6. Storage

- 1) Do not keep capacitor in high temperature and high humidity.
Storage conditions should be:
Temperature: +5°C ~ +35°C
Humidity: Lower than 75%
Place: Indoor
- 2) Avoid ambient conditions where capacitors can be covered with water, brine or oil.
- 3) Avoid ambient conditions where capacitors are exposed to poisonous gases such as hydrogen sulfide, sulfurous acid, nitrous acid, chlorine, ammonium etc.
- 4) Do not keep capacitor in conditions that expose the capacitor to ozone, ultraviolet ray or radiation.
- 5) Store capacitors in a packed condition as much as possible.
- 6) In order to maintain a good solderability of the parts, shelf life of parts should not exceed 1 year.

7. Disposal

- 1) Please dispose capacitors in either of the following ways:
 - ① Incinerate (at a temperature of 800°C or higher) capacitors after crushing parts or making a hole on the capacitor body.
 - ② If incineration is not applicable, hand them over to a waste disposal agent and have them buried in a landfill.
- 2) When removing a capacitor from the circuit board or when disposing of capacitor please ensure that the capacitor is properly discharged.

For further details, please refer to the following industrial standards:

IEC 60384-4 - Fixed capacitors for use in electronic equipment – Part 4: Sectional specification – Fixed aluminum electrolytic capacitors with solid (MnO₂) and non-solid electrolyte (Edition 5.0, 2016-08)

JEITA RCR-2367D - Safety application guide for fixed aluminum electrolytic capacitors for use in electronic equipment (Established in March 1995, Revised in October 2017)

⚠ 鋁電解電容器使用注意事項

使用鋁電解電容器需留意事項：

1. 電路設計

- 1) 確保電容器使用和安裝條件在本產品目錄的規定範圍內。
- 2) 工作溫度和施加的紋波電流應在本產品目錄的規定範圍內。
 - ① 不可在超出最高使用溫度的溫度下使用。
 - ② 不可接通超過最大允許的額定紋波電流。
- 3) 在設計電路時，應選擇符合壽命要求的產品。
- 4) 鋁電解電容器分正負極，不應加反向電壓或交流電壓。對可能出現反向電壓的電路，應選擇無極性電容器。注意：即使無極性電容器，也不能直接用於交流電路。
- 5) 對需要快速充放電的電路，請選用與使用條件相符的鋁電解電容器。作為快速充放電電路的產品有電焊機、相機閃光燈等。此外，電路電壓變動較大，伺服馬達等旋轉設備的控制電路中也會出現反復快速充放電的情況。對於選擇使用於快速充放電電路的鋁電解電容器，可以向我們諮詢。
 導電性高分子固態鋁電解電容器及導電性高分子混合型鋁電解電容器中流過因快速充放電所產生的過大衝擊電流時會導致短路或大幅的漏電流，請確保衝擊電流不超過 10A。

- 6) 請確認不要有超載電壓（超過額定電壓的電壓）通過電容器。
 - ① 直流電壓和紋波電流疊加後的峰值電壓不應超過額定工作電壓。
 - ② 若兩個以上電容器串聯，應確保施加電壓低於額定值，而且要並聯一個平衡電阻，以使每個電容器所加電壓相等。
 導電性高分子固態鋁電解電容器及導電性高分子混合型鋁電解電容器請勿在以下電路中使用，因有可能會無法充分發揮功能或出現故障：
 - a) 耦合電路
 - b) 時間常數電路
 - c) 高阻抗電壓保持電路
 - d) 相對於額定電壓，只施加極低電壓的電路
 - e) 會受到漏電流極大影響的電路，如串聯多個電容器和特殊用途的，請向我們諮詢。

7) 電容器的膠管不能保證絕緣，不能將電容器上的膠管當絕緣用途。若有絕緣要求，請與我們銷售部門聯繫。

- 8) 如果在以下環境中使用，可能會導致電容器故障：
 - ① 周圍環境（耐氣候性）條件：
 - a) 直與水接觸、高溫高濕或結露的環境；
 - b) 直與油接觸或充滿油霧的環境。
 - c) 直接與鹽水接觸或充滿鹽分的環境。
 - d) 充滿有毒氣體（如硫化氫、亞硫酸、氯氣、溴氣、溴甲烷、氨氣等）的環境。
 - e) 置於日照、臭氣、紫外線或放射線照射的環境。
 - f) 直接與酸性或鹼性溶劑接觸的環境。
 - ② 嚴重的振動及機械衝擊超過本產品目錄的規定範圍。

振動的測試條件如下：
 振動頻率範圍：10~55~10Hz
 振動環境頻率：10~55~10Hz/分鐘
 振動迴圈頻率：對數
 振幅或加速度：1.5mm（最大加速度為 10G）
 振動方向：X, Y, Z 方向
 測試時間：每個方向 2 小時

衝擊一般不適用。
 如有特殊要求，請與我們銷售部門聯繫。

- 9) 設計線路板時，應注意下列事項：
 - ① 確保 PC 板上的焊點間距與電容器引線間距相符。
 - ② 電容器的防爆閥上端儘量避免配線及安裝其他元件。
 - ③ 除非另有說明，電容器的防爆閥上端應留有如下的間距：

鋁殼直徑	留出空隙
Ø6.3 ~ 16	2mm 或以上
Ø18 ~ 35	3mm 或以上
Ø40 或以上	5mm 或以上

- ④ 當排氣閥對著 PC 板時（如膠蓋的排氣閥），應在 PC 板上與電容器排氣閥相對應的位置開一小孔，以釋放當排氣閥打開之後所流出的氣體。
- 10) 電解液主要化學溶劑及電解紙為易燃物，且電解液導電。當電解液與 PC 板接觸時，可能會腐蝕 PC 板上的電路，或造成短路，以致生煙或着火。因此在電容器封口下端不應有任何的線路。

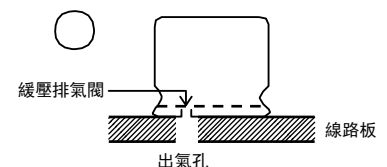
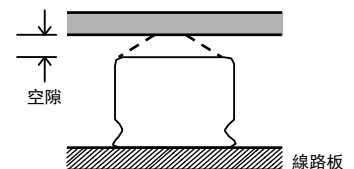

- 11) 設計線路板向背應確保發熱元器件不靠近鋁電解電容器或 PC 板的另一面（電容器下端）。
- 12) 當使用貼片式電容器進行設計時，請參考本產品目錄中的推薦安裝尺寸。
- 13) 設計線路板時應考慮到電性能隨溫度和頻率變化而變化。
- 14) 當兩個以上電容器並聯時，應考慮到通過這些電容器的電流平衡。特別是並聯導電性高分子固態鋁電解電容器、導電性高分子混合型鋁電解電容器和普通鋁電解電容器時，更需要考慮。
- 15) 在雙面線路板上安裝電容器時，電容器的安裝位置應避開多餘的基板孔和過孔。

2. 安裝

- 1) 一旦電容器經過安裝及加載，不要再試圖用於其他線路板或其他用途。
- 2) 當電容器產生再生電壓時，需通過 1KΩ 左右的電阻進行放電。
- 3) 對儲存較長時間（超過 2 年）的電容器，其漏電流可能會增大。若漏電流增大，請使用 1KΩ 左右的電阻做充電處理。
- 4) 將電容器安裝在 PC 板上之前，請確認其規格（靜電容量及額定電壓等）與極性。
- 5) 請不要將電容器掉在地上，或不要使用掉在地上的電容器。
- 6) 安裝時請不要損傷電容器。
- 7) 安裝前，請確認電容器引線與 PC 板上的孔距相吻合。
- 8) 請留意自動插入機的機械手力量不宜過大。
- 9) 請確認貼片機的吸頭、產品檢測夾具或對中裝置對電容器的機械衝擊。
- 10) 手工焊接：
 - ① 當使用手工焊接鋁電解電容器時，不可超過 260°C 10 秒或 350°C 3 秒。
 - ② 絕對不要將烙鐵接觸到電容器的本體，接觸本體會導致膠管破裂或熔化。
 - ③ 如果要卸下焊接好的電容器，請將焊劑充分溶化後再拆卸，以免電容器的端子受到拉力。

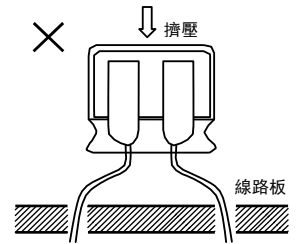

- 11) 波峰焊：
 - ① 任何時候不要將鋁電解電容器浸入到焊錫溶液中，那樣會導致電容器內部氣壓上升，造成電容器損壞。
 - ② 鋁電解電容器只能安裝在線路版的上層。
 - ③ 電容器的最高焊接溫度為 260°C 10 秒。
 - ④ 預熱溫度不可超過 125°C 30 秒。
 - ⑤ 焊接時不要讓其他元器件接觸到電容器，那樣可防止其他元器件的高溫傳到電容器上而損壞膠管。
- 12) 回流焊（只適用於表面貼裝）：
 - ① 請遵守本產品目錄中的“焊接條件”。
 - ② 當使用紅外線加熱時，請注意加熱程度，因為紅外線吸收率會隨著電容器顏色和大小的不同而改變。
- 13) 電容器焊接在 PC 板後，不要傾斜或扭動電容器。
- 14) 不要抓住焊接後的電容器搬動 PC 板。
- 15) 請在焊接後不要讓任何物品與電容器接觸。如 PC 板堆放儲存，請確保 PC 板或其他零部件不與電容器接觸。焊接後的電容器不應受到任何已焊接 PC 板或其他零件熱輻射的影響。
- 16) 清洗
 - ① 不要用鹵化物清洗劑清洗電容器。
 - ② 推薦清洗方法：

使用範圍：任何類型及規格

清洗劑：

乙醇類清洗劑：Isopropyl Alcohol（異丙醇）

水性清洗劑：

高級乙醇類：Pine Alpha ST-100S, Techno Care FRW14~17, Sanelek B-12

介面活性劑類：cleaning through 750H/750L/710M

鹼性皂化類：Aqua Cleaner 210SEP

清洗條件：使用浸泡、超聲波等方法，總清洗時間不可超過 5 分鐘（清洗劑溫度應在 60°C 或以下）。貼片型和超小型產品的總清洗時間應在 2 分鐘以內（清洗劑溫度應在 40°C 或以下）。

清洗後，請將電容器和安裝完畢的電路板一起用熱風吹至少 10 分鐘至吹乾。當洗滌液落入了外殼和膠管時，如果熱風的溫度過高，會導致膠管變軟和膨脹，所以熱風的溫度不要超過膠管變軟的溫度（80°C）。

水洗後若不充分吹乾，可能會導致膠管二次收縮、座板膨脹等外觀不良。此外，請充分做好清洗劑的污染管理（電導率、pH 值、比重、含水量等）。清洗後，請勿將電容器保存在清洗液的環境中或密封容器內。另外，在進行噴射清洗時，由於噴射的角度和強度不同，有可能會造成膠管膨脹。在不同程度的情況下，膠管上的絲印標識也會變得模糊或脫落。

在使用不同於以上的推薦清洗方法和清洗劑之前，請諮詢我們。
 - ③ 避免使用破壞臭氧層的清洗劑以保護環境。
- 17) 固定劑、塗層劑
 - ① 請勿使用任何含有鹵素的固定劑或塗層劑。
 - ② 線路板和電容器封口膠之間，不可留有焊劑殘渣及污垢。
 - ③ 在使用固定劑或塗層劑之前，盡可能不殘留洗淨成份，進行乾燥處理，使印刷孔不堵塞。

- ④ 在使用固定劑或塗層劑時，請勿將之塗滿整個電容器的封口膠部分。
固定劑和塗層劑的種類很多，為避免發生問題，可向相關材料廠家或聯繫我們的銷售部門諮詢詳情。

18) 薰蒸處理

作為出口時的防蟲措施，有時會使用鹵化物（如甲基溴）進行薰蒸處理。將鋁電解電容器及裝配有鋁電解電容器的電子產品直接薰蒸或將進行薰蒸處理的木材用於托架時，由於薰蒸劑中含有鹵素，可能會導致電容器的內部引起腐蝕反應。

3. 安裝後

- 1) 不要直接用手接觸電容器正負極。
- 2) 不要在正負極之間用導體短接，也不要將電容器上或附近濺撒導電液體，如鹼液等。
- 3) 請確認所安裝的電容器不要處於以下環境：
 - ① 直接與水接觸、高溫高濕或易結露的環境。
 - ② 直接與油接觸及充滿油霧的環境。
 - ③ 直接與鹽水接觸、高溫高濕或易結露的環境。
 - ④ 充滿鹽酸有機氣體（如硫化氫及亞硫酸、亞硝酸、氯氣、溴氣、溴甲烷等）的環境。
 - ⑤ 充滿有毒的鹼性氣體（如氨氣等）的環境。
 - ⑥ 直接與酸性或鹼性接觸的環境。
 - ⑦ 結露環境有可能導致膠管發生收縮、膨脹、破裂，因此在使用時請充分進行確認。此外，因溫度劇烈變化，高溫高濕試驗等而結露時，也可能導致同樣的膠管異常。

4. 維護和檢驗

請定期檢驗安裝在工業設備上的電容器，檢驗項目如下：

- 1) 外觀：明顯缺陷，如防爆閥裂開、漏液等。
- 2) 電性能：電容量、損耗角正切、漏電流等，具體請查閱本產品目錄中的詳細規格資料。

5. 緊急情況

- 1) 如看到防爆閥開啟冒煙，要立即關掉總開關或拔掉插頭。
- 2) 不要將臉朝向防爆閥，因當防爆閥開啟時，將有超過 100°C 的氣體泄出。若氣體進入眼中，應立即用清水沖洗眼睛。若吸入氣體，應立即用水清洗口腔和喉嚨。
- 3) 不要吞食電解液。若皮膚沾上電解液，請用肥皂和水清洗乾淨。

6. 儲存

- 1) 不要將電容器儲存在高溫和濕度高的地方。儲存環境應為：
 - 溫度：+5°C ~ +35°C
 - 相對濕度：低於 75%
 - 儲存場所：室內
- 2) 避免儲存在有水、鹽水或油的環境中。
- 3) 避免儲存在有毒氣體（如硫化氫、亞硫酸、亞硝酸、氯及氨等）的環境中。
- 4) 避免電容器接觸氧層、紫外線或輻射。
- 5) 盡可能的把電容器保存在原來的封裝袋裏。
- 6) 為確保良好的焊接性，請將電容器的保存期限控制在 1 年以內。

7. 棄置

- 1) 請用下列任何一種方法棄置電容器：
 - ① 在電容器的殼體上開孔後或完全解體破開後置於火中焚毀（用 800°C 或更高的溫度）。
 - ② 電容器不作焚毀時，交給工業垃圾處理機構進行填埋處理。
- 2) 當廢棄電容器或從線路板上卸下時，請確認電容器已經放電。

欲知更多詳情，請參閱以下行業標準：

IEC 60384-4 - Fixed capacitors for use in electronic equipment – Part 4: Sectional specification – Fixed aluminum electrolytic capacitors with solid (MnO₂) and non-solid electrolyte (Edition 5.0, 2016-08)

JEITA RCR-2367D - Safety application guide for fixed aluminum electrolytic capacitors for use in electronic equipment (Established in March 1995, Revised in October 2017)

EXPLANATION OF PART NUMBERS 產品編碼規則

□ For Conductive Polymer Aluminum Solid Electrolytic Capacitors 適用於導電性高分子固態鋁電解電容器

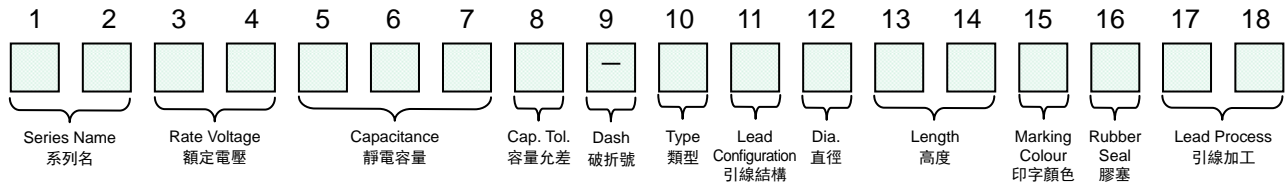

(1, 2)		(3, 4)		(5-7)		(8)		(10)		(12)		(13, 14)	
Series 系列	Code 代碼	Voltage (W.V.) 電壓	Code 代碼	Capacitance (μF) 靜電容量	Code 代碼	Cap. Tolerance (%) 容量允差	Code 代碼	Type 類型	Code 代碼	Diameter (∅) 直徑	Code 代碼	Length (mm) 高度	Code 代碼
MA	0E	2.5	0E	3.3	3R3	±10	K	Chip 貼片	C	4	C	4.2	42
MB	0G	4	0G	4.7	4R7	±20	M	Radial 引線	R	4.5	W	5.5	55
MR	0J	6.3	0J	6.8	6R8			Radial Taping 引線編帶	T	5	D	5.7	57
MS	0B	6.8	0B	10	100					5.5	Y	5.8	58
MX	0T	7.5	0T	15	150					6.3	E	6	06
MX	0T	7.5	0T	22	220					6.5	B	6.5	65
MV	1A	10	1A	33	330					6.5	B	6.7	67
PA	1F	12	1R	39	390					8	F	7	07
PB	1C	14	1F	47	470					8.2	A	7.7	77
PR	1Z	16	1C	56	560					10	G	8	08
PS	1D	18	1Z	68	680					10	G	9	09
PX	1E	20	1D	82	820					12	H	10	10
PV	1U	25	1E	100	101					12	H	10.2	1S
	1V	30	1U	150	151							10.5	1D
	1V	35	1V	220	221							11	11
	1G	40	1G	270	271							12	12
	1H	50	1H	330	331							12.5	1B
	1J	63	1J	390	391							12.7	1T
	1T	75	1T	470	471							13	13
	1K	80	1K	680	681							13.5	1C
	1R	85	1R	820	821							16	16
	2A	100	2A	1000	102							21	21
	2B	125	2B	1200	122								
				1500	152								
				1800	182								
				2200	222								
				2700	272								

Type 類型	Lead Configuration 引線結構	Code 代碼
Chip 貼片	Taping & Reel 編帶與卷盤	R
	Taping & Plastic Reel 編帶與塑料卷盤	T
Radial 引線	Bulk 散裝	B
	Taping (Straight) 編帶 (直腳)	S
	Lead Cutting 剪腳	C

Marking Colour 印字顏色	Code 代碼
Black print on the case top 鋁殼頂部黑字印刷	S
Navy Blue print on the case top 鋁殼頂部深藍字印刷	B
Red print on the case top 鋁殼頂部紅字印刷	R

Rubber Seal 膠塞	Code 代碼
Flat 平台	P
Stand-off 凸台	T

Lead Process 引線加工	Code 代碼
Standard 標準	00
Lead length after cut is 3mm 剪腳腳長 3mm	30
Lead length after cut is 4.5mm 剪腳腳長 4.5mm	45
Lead length after cut is 5mm 剪腳腳長 5mm	50
Lead length after cut is 7.5mm 剪腳腳長 7.5mm	75
Lead length after cut is 10mm 剪腳腳長 10mm	1A
Lead length after cut is 12mm 剪腳腳長 12mm	1B
Lead length after cut is 13mm 剪腳腳長 13mm	1C
Lead length after cut is 15mm 剪腳腳長 15mm	1D

● Note: The part number of Chip Type Conductive Polymer Aluminum Solid Electrolytic Capacitors is indicated with 1~14 digits.
 ● 注：貼片式導電性高分子固態鋁電解電容器的產品編碼只需使用 1~14 位代碼。

EXPLANATION OF PART NUMBERS 產品編碼規則

□ For Conductive Polymer Hybrid Aluminum Electrolytic Capacitors 適用於導電性高分子混合型鋁電解電容器

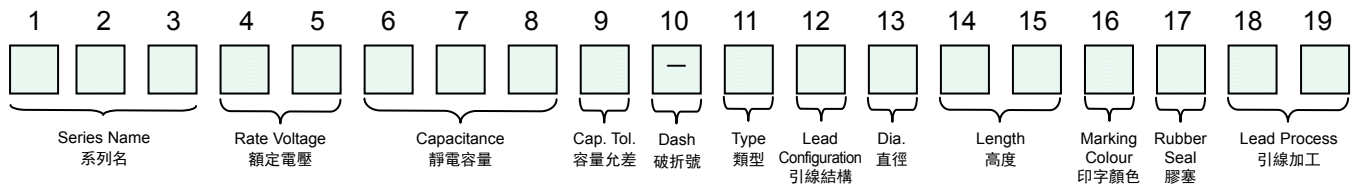

(1~3)		(4, 5)		(6~8)		(9)		(11)		(13)		(14, 15)	
Series 系列	Voltage (W.V.) 電壓	Code 代碼	Capacitance (μF) 靜電容量	Code 代碼	Cap. Tolerance (%) 容量允差	Code 代碼	Type 類型	Code 代碼	Diameter (∅) 直徑	Code 代碼	Length (mm) 高度	Code 代碼	
HMB	16	1C	22	220	±10%	K	Chip 貼片	C	6.3	E	6	06	
HMR	20	1D	33	330	±20%	M	Radial 引線	R	8	F	6.7	67	
HMX	25	1E	39	390			Radial Taping 引線編帶	T	10	G	7	È È	
HPB	35	1V	47	470							7.7	77	
HPR	40	1G	56	560							8	08	
MPX	50	1H	68	680			Chip 貼片	Taping & Reel 編帶與卷盤	R		9	09	
	63	1J	82	820							Radial 引線	Taping (Straight) 編帶 (直腳)	S
	75	1T	100	101			Bulk 散裝	Lead Cutting 剪腳	C				
	80	1K	150	151							Taping & Plastic Reel 編帶與塑料卷盤	T	
	85	1R	220	221			Lead Cutting 剪腳	C					
	100	2A	270	271							Lead Cutting 剪腳	C	
			330	331			Lead Cutting 剪腳	C					
			390	391									
			470	471									
			680	681									
		820	821										
		1000	102										
		1200	122										
		1500	152										

(16)	
Marking Colour 印字顏色	Code 代碼
Black print on the case top 鋁殼頂部黑字印刷	S
Navy Blue print on the case top 鋁殼頂部深藍字印刷	B
Red print on the case top 鋁殼頂部紅字印刷	R

(17)	
Rubber Seal 膠塞	Code 代碼
Flat 平台	P
Stand-off 凸台	T

(18, 19)	
Lead Process 引線加工	Code 代碼
Standard 標準	00
Lead length after cut is 3mm 剪腳腳長 3mm	30
Lead length after cut is 4.5mm 剪腳腳長 4.5mm	45
Lead length after cut is 5mm 剪腳腳長 5mm	50
Lead length after cut is 7.5mm 剪腳腳長 7.5mm	75
Lead length after cut is 10mm 剪腳腳長 10mm	1A
Lead length after cut is 12mm 剪腳腳長 12mm	1B
Lead length after cut is 13mm 剪腳腳長 13mm	1C
Lead length after cut is 15mm 剪腳腳長 15mm	1D

● Note: The part number of Chip Type Conductive Polymer Hybrid Aluminum Electrolytic Capacitors is indicated with 1~15 digits.
 ●注：貼片式導電性高分子混合型鋁電解電容器的產品編碼只需使用 1~15 位代碼。

EXPLANATION OF PART NUMBERS 產品編碼規則

□ For Aluminum Electrolytic Capacitors 適用於鋁電解電容器

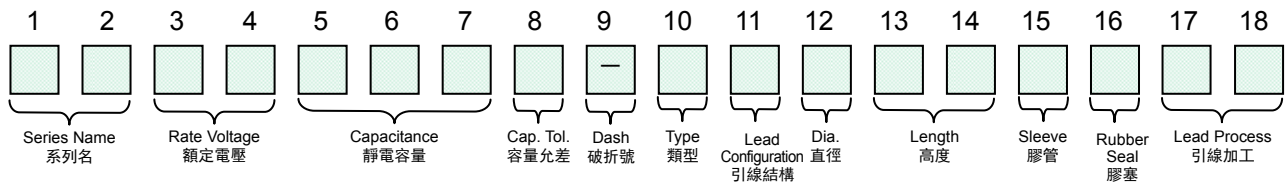

(1, 2)		(3, 4)		(5-7)		(8)		(10)			(12)		(13, 14)	
Series 系列	Voltage (W.V.) 電壓	Code 代碼	Capacitance (μF) 靜電容量	Code 代碼	Cap. Tolerance (%) 容量允差	Code 代碼	Type 類型	Lead Configuration 引線結構	Code 代碼	Diameter (φ) 直徑	Code 代碼	Length (mm) 高度	Code 代碼	
CS	4	0G	0.1	0R1	±10	K	Chip 貼片	Taping & Reel 編帶與卷盤	C	3	S	5	05	
CK	6.3	0J	0.22	R22	±15	L	Radial 引線	Taping & Plastic Reel 編帶與塑料卷盤	R	4	C	5.4	54	
SC	10	1A	0.33	R33	±20	M	Radial Taping 引線編帶	Snap-in 導箔	T	5	D	5.8	58	
CN	16	1C	0.47	R47	+20	V	Radial 引線	Bulk 散裝	B	6.3	E	6.2	62	
KP	25	1E	1	010	-10			Chip 貼片	Taping (Forming) 編帶(成型)	A	8	F	7	07
KZ	35	1V	2.2	2R2	+20	0		R	Taping (Straight) 編帶(直腳)	S	10	G	7.7	77
LZ	40	1G	3.3	3R3	R	Snap-in 導箔		Lead Cutting 剪腳	C	12	H	8	08	
FZ	50	1H	4.7	4R7				Lead Cutting (Straight P=2.0mm) 剪腳(直腳 P=2.0mm)	D	10.5	1D	12.5	I	9
EL	63	1J	6.8	6R8	Lead Forming Cut 成型剪腳			F	10	11	13.5	J	10	10
KH	80	1K	10	100	Lead Forming Only 引線成型			M	12.5	12	13.5	V	10.5	10D
CP	85	1R	15	150	Kinked Forming Cut 彎曲成型剪腳			K	13	13	14.5	A	11.5	1A
CH	100	2A	22	220	Kinked Straight Cut 彎曲直腳剪腳			Y	13.5	14	16	K	12	12
HU	125	2B	33	330	Cutting & Bending (Left) 左向臥式成型剪腳			L	16	16	16.5	L	12.5	1B
RA	160	2C	47	470	Cutting & Bending (Right) 右向臥式成型剪腳		R	20	20	20	M	13	13	
RK	180	2Z	68	680	Sleeveless (Black print on the case top) 無膠管(鋁殼頂部黑字印刷)		S	25	25	21	N	13.5	1C	
RE	200	2D	100	101				26	26	25	O	14	14	
RM	220	2N	150	151			26	26	25	P	16	16		
RS	250	2E	220	221			26	26	25	Q	16.5	1E		
LA	315	2F	270	271			26	26	25	R	20	20		
LK	330	2U	330	332			26	26	25		21	21		
LM	350	2V	470	472			26	26	25		25	25		
LS	360	2X	560	562			26	26	25		26	26		
NP	400	2G	680	682			26	26	25		26	26		
NK	420	2M	10000	103			26	26	25		26	26		
NM	450	2W	12000	123			26	26	25		26	26		
NS	500	2H	15000	153			26	26	25		26	26		
BP			18000	183			26	26	25		26	26		
BH			22000	223			26	26	25		26	26		
TM							26	26	25		26	26		
TN							26	26	25		26	26		
TL							26	26	25		26	26		
TW							26	26	25		26	26		
TY							26	26	25		26	26		
TB							26	26	25		26	26		
TX							26	26	25		26	26		
PL							26	26	25		26	26		
SM							26	26	25		26	26		
SK							26	26	25		26	26		
SP							26	26	25		26	26		
SH							26	26	25		26	26		
ST							26	26	25		26	26		

● Note: The part number of Chip Type Aluminum Electrolytic Capacitors is indicated with 1~14 digits.
 ● 注: 貼片式鋁電解電容器的產品編碼只需使用 1~14 位代碼。

TAPING & PACKAGING SPECIFICATIONS 編帶與包裝標準

□ For Chip Type Capacitors 適用於貼片式電容器 

■ Carrier Tape Dimensions 載帶尺寸

● $\varnothing 4 \sim \varnothing 10$ (mm)

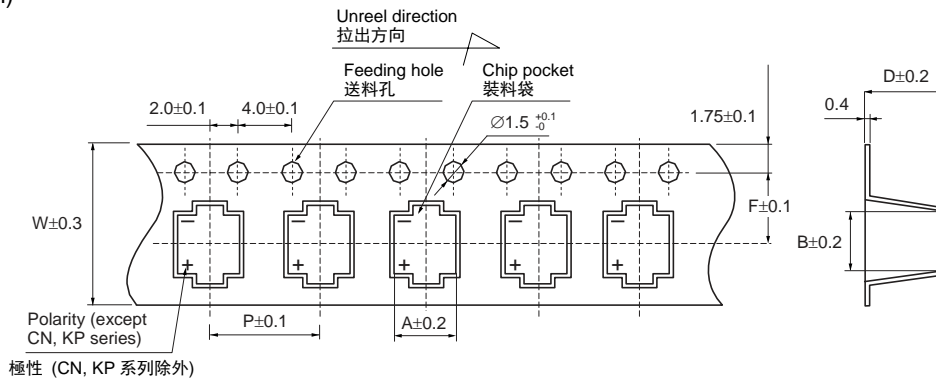

Dimension 尺寸表 (Unit: mm)

$\varnothing D \times L$	4×5.4/5.8	5×5.5/4.8/9	6.3×5.4/6.5	6.3×7.7/9	6.3×10.5/11.5	8×6/6.7/7	8×7.7/8/9	8×10.5/12/12.5	10×8/10/10.5	10×12.5/13.5
W	12.0	12.0	16.0	16.0	16.0	24.0	24.0	24.0	24.0	24.0
P	8.0	12.0	12.0	12.0	12.0	12.0	16.0	16.0	16.0	16.0
F	5.5	5.5	7.5	7.5	7.5	11.5	11.5	11.5	11.5	11.5
A	5.0	6.0	7.0	7.0	7.0	8.7	8.7	8.7	10.7	10.7
B	5.0	6.0	7.0	7.0	7.0	8.7	8.7	8.7	10.7	10.7
D	5.9/5.9	5.9/5.9/8.1/9.2	5.9/6.9	8.2/9.9	11.0/12.5	6.8/6.8/7.5	8.2/8.2/9.9	11.0/12.5/13.0	8.4/11.0/11.0	13.0/14.0

● $\varnothing 12.5 \sim \varnothing 18$ (mm)

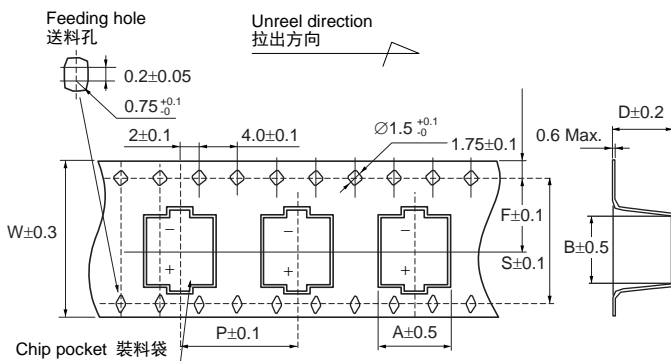

Dimension 尺寸表 (Unit: mm)

$\varnothing D \times L$	12.5×13.5	12.5×16	16×16.5	18×16.5/18.5
W	32.0	32.0	44.0	44.0
P	24.0	24.0	28.0	32.0
F	14.2	14.2	20.2	20.2
A	14.0	14.0	17.5	19.5
B	14.0	14.0	17.5	19.5
D	14.0	17.5	17.5	17.5/20.5
S	28.4	28.4	40.4	40.4

■ Reel Dimensions 卷盤尺寸

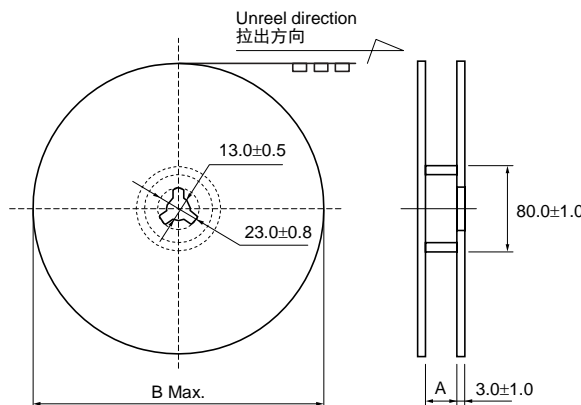

(Unit: mm)

$\varnothing D$	$\varnothing 4, \varnothing 5$	$\varnothing 6.3$	$\varnothing 8, \varnothing 10$	$\varnothing 12.5$	$\varnothing 16, \varnothing 18$
A±1.0	14	17	25.5	34.5	44
B (Max.)	382	382	382	382	382

Note: All design and specifications are for reference only and is subject to change without prior notice. If any doubt about safety for your application, please contact us immediately for technical assistance before purchase.

注：以上所提供的設計及特性參數僅供參考，任何修改不作預先通知。如果在使用上有疑問，請在採購前與我們聯繫，以便提供技術上的協助。

CAT.2023/V2

■ Packaging Quantity 包裝數量

□ For Chip Type Aluminum Electrolytic Capacitors 適用於貼片式鋁電解電容器

Case Size ∅D × L (mm) 尺寸	Quantity/Reel (pcs) 數量/卷 (個)	Reels/Box 卷盤/箱	Quantity/Carton (pcs) 數量/外箱 (個)	Carton Box Size 外箱尺寸 L × H × W (mm)
4 × 5.4, 5.8	2,000*	12	24,000	400 × 390 × 245
5 × 5.4, 5.8	1,000*	12	12,000	
6.3 × 5.4, 5.8, 7.7	1,000*	10	10,000	
6.3 × 10.5	750*	10	7,500	
6.3 × 11.5	500*	10	5,000	
8 × 6.2	1,000*	10	10,000	
8 × 10.5, 12.5	500*	7	3,500	
10 × 10.5, 12.5, 13.5	500*	7	3,500	
12.5 × 13.5	250*	6	1,500	
12.5 × 16	200*	6	1,200	
16 × 16.5	150*	4	600	
18 × 16.5, 18.5	125*	4	500	

□ For Chip Type Conductive Polymer Aluminum Solid Electrolytic Capacitors & Chip Type Conductive Polymer Hybrid Aluminum Electrolytic Capacitors
適用於貼片式導電性高分子固態鋁電解電容器及貼片式導電性高分子混合型鋁電解電容器

Case Size ∅D × L (mm) 尺寸	Quantity/Reel (pcs) 數量/卷 (個)	Reels/Box 卷盤/箱	Quantity/Carton (pcs) 數量/外箱 (個)	Carton Box Size 外箱尺寸 L × H × W (mm)
4 × 5.5	2,000*	12	24,000	400 × 390 × 245
5 × 5.5~8	1,000*	12	12,000	
5 × 9	750*	12	9,000	
6.3 × 5.5~8	1,000*	10	10,000	
6.3 × 9~9.5	750*	10	7,500	
8 × 6.7~7.7	750*	8	6,000	
8 × 8~12	500*	8	4,000	
10 × 8~10.5	500*	8	4,000	
10 × 12.5	450*	8	3,600	

* Minimum package quantity *最小包裝數量

- There are some differences between actual package quantity and above list. Please confirm before you order.
- Please order by minimum package quantity.
- 以上包裝標準可能會與實際的包裝數量有所不同，請在訂購前確認。
- 請以最小包裝數量訂購。

Note: All design and specifications are for reference only and is subject to change without prior notice. If any doubt about safety for your application, please contact us immediately for technical assistance before purchase.

注：以上所提供的設計及特性參數僅供參考，任何修改不作預先通知。如果在使用上有疑問，請在採購前與我們聯繫，以便提供技術上的協助。

CAT.2023/V2

TAPING SPECIFICATIONS 編帶標準

□ For Automatic Insertion (Radial Lead Type Capacitors) 自動插件用 (適用於引線式電容器)



■ Drawing (Unit: mm) 外形圖

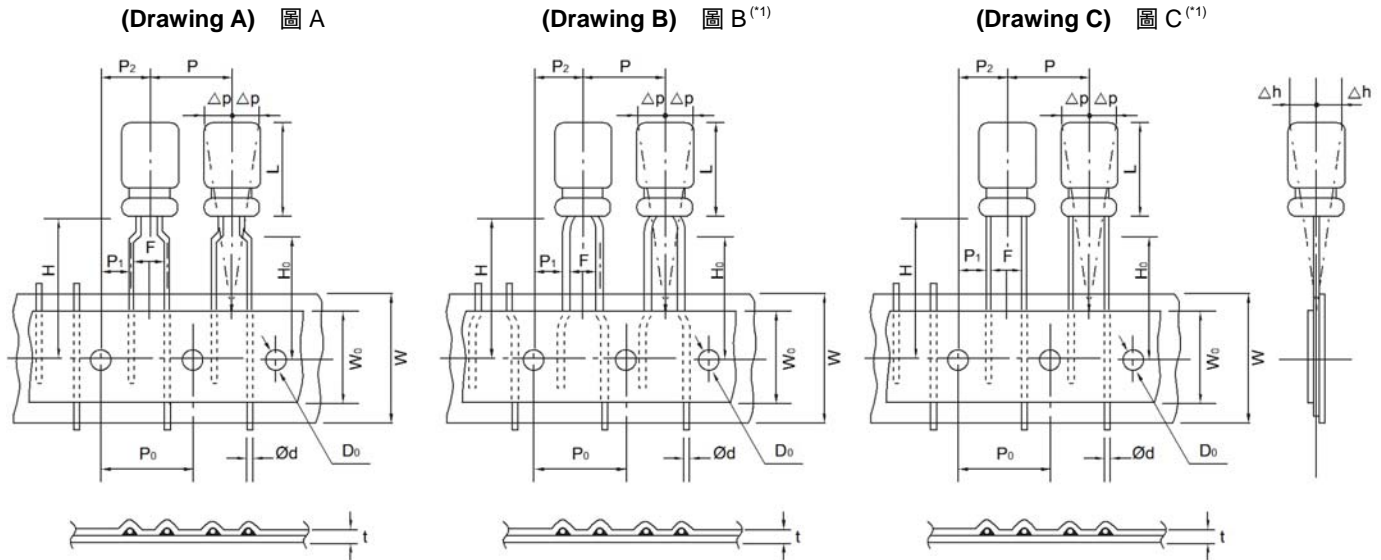

■ Dimensions (Unit: mm) 尺寸表

Application to Drawing 對應外形圖			B ^(*)				C ^(*)				A						C ^(*)							
Descriptions 內容	Symbol 符號	Tolerance 允差	Ø3	Ø4	Ø5	Ø5	Ø6.3	Ø8	Ø4	Ø5	Ø6.3	Ø8	Ø4	Ø5	Ø6.3	Ø8	Ø10	Ø13	Ø16,Ø18					
Case Height 鋁殼高度	L	Note ⁽²⁾	5	5,7	5,7	11	5,7	11	5	7-14	16,20	5,7	5,7	11	5,7	11,5	5	7,9	11,5-20	20 (Max.)	25 (Max.)	35,40 (Max.)		
Lead Wire Diameter 引線直徑	Ød	±0.05	0.45	0.45	0.45	0.5	0.45	0.5	0.45	0.5	0.6	0.45	0.45	0.5	0.45	0.5	0.45	0.5	0.6	0.6	0.6	0.8		
Body Pitch 電容器本體間距	P	±1.0	12.7		12.7		12.7		12.7			12.7			12.7		12.7		12.7		15.0		30.0	
Feeding Hole Pitch 運送孔間距	P ₀	±0.2	12.7		12.7		12.7		12.7			12.7			12.7		12.7		12.7		15.0		15.0	
Feeding Hole Center to Lead 運送孔至引線寬度	P ₁	±0.7	5.1		5.1		5.1		5.1			3.85			3.85		3.85		3.85		5.0		3.75	
Feeding Hole Alignment 運送孔至電容器本體寬度	P ₂	±1.0	6.35		6.35		6.35		6.35			6.35			6.35		6.35		6.35		7.5		7.5	
Lead Center Spacing 引線間距	F	+0.8 -0.2	2.5		2.0		2.5		3.5			5.0			5.0		5.0		5.0		5.0		7.5	
Tape Width 紙帶寬度	W	±0.5	18.0		18.0		18.0		18.0			18.0			18.0		18.0		18.0		18.0		18.0	
Adhesive Tape Width 熱熔膠帶寬度	W ₀	Min.	10.0		10.0		10.0		12.0			10.0			12.0		12.0		12.0		12.0		12.0	
Length from Seating Plane 電容器本體至紙帶中心高度	H	±0.75	17.5 (11L=18.5)		17.5		18.5		18.5			18.5 (5,7L=17.5)			18.5		18.5		20.0		18.5		18.5	
Lead Clinch Height 引線彎曲至運送孔高度	H ₀	±0.5	17.0		17.0		—		—			16.0			16.0		16.0		—		—		—	
Feeding Hole Diameter 運送孔直徑	ØD ₀	±0.2	4.0		4.0		4.0		4.0			4.0			4.0		4.0		4.0		4.0		4.0	
Total Tape Thickness 紙帶與膠帶的總厚度	t	±0.3	0.7		0.7		0.7		0.7			0.7			0.7		0.7		0.7		0.7		0.7	
Body Inclination 電容器本體傾斜度	△h	Max.	1.0		1.0		1.0		1.0			1.0			1.0		1.0		1.0		1.0		1.0	
Body Inclination 電容器本體傾斜度	△p	Max.	1.0		1.0		1.0		1.0			1.0			1.0		1.0		1.0		1.0		1.0	
Taping Code 編帶代碼			TS		TE		TS		TS			TA			TA		TA		TS		TS		TS	

^(*) For Radial Lead Type Conductive Polymer Aluminum Solid Capacitors & Radial Lead Type Conductive Polymer Hybrid Aluminum Capacitors only. Please consult with us before you order.
僅適用於引線式導電性高分子固態鋁電解電容器及引線式導電性高分子混合型鋁電解電容器。請在訂購前向我們諮詢。

⁽²⁾ Please refer to the drawing of each series for tolerance. 請查閱相應系列外形圖的允許誤差。

Note: All design and specifications are for reference only and is subject to change without prior notice. If any doubt about safety for your application, please contact us immediately for technical assistance before purchase.
注：以上所提供的設計及特性參數僅供參考，任何修改不作預先通知。如果在使用上有疑問，請在採購前與我們聯繫，以便提供技術上的協助。

PACKAGING SPECIFICATIONS 包裝標準

■ Taping Type (Ammo pack) 編帶品 (折疊式包裝)

☐ For Aluminum Electrolytic Capacitors 適用於鋁電解電容器

Type 類型	Diameter (mm) 直徑	In-box Size 內盒尺寸	Quantity/In-box (pcs) 數量/內盒 (個)	Quantity/ Carton (pcs) 數量/箱 (個)
		L × H × W (mm)		
Radial Lead Type 直插式	∅3	337 × 234 × 50	2,500*	25,000
	∅4	337 × 234 × 50	2,500*	25,000
	∅5	337 × 234 × 50	2,000*	20,000
	∅6.3	325 × 290 × 55	2,000*	10,000
	∅8	337 × 234 × 50	1,000*	10,000
	∅10	327 × 182 × 60	500*	4,000
	∅13	340 × 305 × 65	500*	2,000
	∅16 (25L)	340 × 320 × 65	300*	1,200
∅18 (25L)	340 × 320 × 65	250*	1,000	

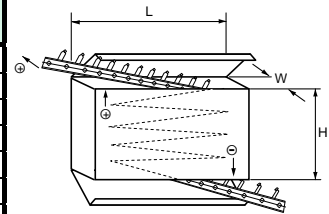

☐ For Conductive Polymer Aluminum Solid Electrolytic Capacitors & Conductive Polymer Hybrid Aluminum Electrolytic Capacitors
適用於導電性高分子固態鋁電解電容器及導電性高分子混合型鋁電解電容器

Radial Lead Type 直插式	∅4	337 × 235 × 50	2,500*	25,000
	∅5	337 × 235 × 50	2,000*	20,000
	∅6.3	325 × 290 × 55	2,000*	10,000
	∅8	337 × 235 × 50	1,000*	10,000
	∅10	327 × 182 × 60	500*	4,000

■ Bulk Type 散裝品

☐ For Aluminum Electrolytic Capacitors 適用於鋁電解電容器

Type 類型	Case Size ∅D×L (mm) 尺寸	Vinyl Bag Quantity 膠袋數量		Small Box Quantity 內箱數量				Carton Box Quantity 外箱數量		Small Box Size 內箱尺寸 L × H × W (mm)	Carton Box Size 外箱尺寸 L × H × W (mm)	
		pcs/Bag 個/膠袋		Vinyl Bag/Small Box 膠袋/內箱		pcs/Small Box 個/內箱		Small Box/ Carton Box 內箱/外箱	pcs/Carton Box 個/外箱			
		Long Lead 長腳	Lead Cutting/Forming 剪腳/成型	Long Lead 長腳	Lead Cutting/Forming 剪腳/成型	Long Lead 長腳	Lead Cutting/Forming 剪腳/成型		Long Lead 長腳			Lead Cutting/Forming 剪腳/成型
Radial Lead Type 直插式	3 × 5	1,000*	—	50	—	50,000	—	2	100,000	300 × 290 × 220	470 × 310 × 310	
	4 × 5, 7	1,000*	—	25	—	25,000	—	50,000				
	5 × 5, 7	1,000*	—	25	—	25,000	—	50,000				
	5 × 11	1,000*	—	20	—	20,000	—	40,000				
	6.3 × 5	1,000*	—	25	—	25,000	—	50,000				
	6.3 × 7	1,000*	—	20	—	20,000	—	40,000				
	6.3 × 11.5	500*	—	30	—	15,000	—	30,000				
	8 × 5-11.5	500*	—	20	—	10,000	—	20,000				
	8 × 13-16	250*	—	30	—	7,500	—	15,000				
	8 × 20	250*	—	24	—	6,000	—	12,000				
	10 × 12-17	200*	—	25	—	5,000	—	10,000				
	10 × 20	200*	—	20	—	4,000	—	8,000				
	10 × 25-30	100*	—	25	—	2,500	—	5,000				
	13 × 17-25	100*	—	10	—	1,000	—	4,000				
	13 × 30, 35	50*	—	30	—	1,500	—	3,000				
Snap-in Terminal Type 插接式	16 × 20-35	—	—	—	—	300*	—	4	1,200	340 × 65 × 305	360 × 280 × 320	
	18 × 20-31	—	—	—	—	250*	—	4	1,000	340 × 65 × 305		
	18 × 35-40	—	—	—	—	250*	—	4	1,000	340 × 87 × 305	355 × 280 × 315	
	22 × 25-40	—	—	—	—	180*	—	720				
	25 × 25-40	—	—	—	—	143*	—	572				
	22 × 25-40	—	—	—	—	156*	—	4	624	340 × 65 × 305	355 × 280 × 315	
	25 × 25-40	—	—	—	—	132*	—	528				
	30 × 25-40	—	—	—	—	90*	—	360				
	35 × 25-40	—	—	—	—	72*	—	288	340 × 87 × 305	355 × 280 × 315		
	22 × 45-75	—	—	—	—	156*	—	468				
25 × 45-75	—	—	—	—	132*	—	396					
30 × 45-75	—	—	—	—	90*	—	270					
35 × 45-75	—	—	—	—	72*	—	216	216				

☐ For Conductive Polymer Aluminum Solid Electrolytic Capacitors & Conductive Polymer Hybrid Aluminum Electrolytic Capacitors 適用於導電性高分子固態鋁電解電容器及導電性高分子混合型鋁電解電容器

Radial lead Type 直插式	5 × 7-12	1,000*	1,000*	8	16	8,000	16,000	4	32,000	64,000	310 × 140 × 200	420 × 220 × 295
	6.3 × 6-9	1,000*	1,000*	8	8	8,000	10,000		32,000	40,000		
	6.3 × 10.5-12	500*	1,000*	8	8	4,000	8,000		16,000	32,000		
	8 × 7-9	500*	1,000*	8	8	4,000	8,000		16,000	32,000		
	8 × 11-16	500*	500*	8	8	4,000	4,000		16,000	16,000		
	10 × 8-13	250*	500*	8	8	2,000	4,000		8,000	16,000		
	10 × 16-21	200*	400*	8	8	1,600	3,200		6,400	12,800		

* Minimum package quantity *最小包裝數量

- There are some differences between actual package quantity and above list. Please confirm before you order.
- Please order by minimum package quantity.
- 以上包裝標準可能會與實際的包裝數量有所不同，請在訂購前確認。
- 請以最小包裝數量訂購。

Note: All design and specifications are for reference only and is subject to change without prior notice. If any doubt about safety for your application, please contact us immediately for technical assistance before purchase.

注: 以上所提供的設計及特性參數僅供參考，任何修改不作預先通知。如果在使用上有疑問，請在採購前與我們聯繫，以便提供技術上的協助。

CAT.2023/V2

LEAD FORMING & CUTTING 引線成型及剪腳

☐ For Radial Lead Type Capacitors 適用於引線式電容器



(Unit: mm)

Configurations 結構類型	Code 代碼	Case dia. 直徑	Shape 外形圖	Configurations 結構類型	Code 代碼	Case dia. 直徑	Shape 外形圖
Forming Cut 成型剪腳 (Forming Only 成型不剪腳)	RF (RM)	Ø4~Ø8		Kinked Forming Cut 彎曲成型剪腳	RK	Ø4~Ø8	
Straight Cut ^(*) 直腳剪腳 ^(*)	RC	Ø4~ Ø22		Kinked Straight Cut 彎曲直腳剪腳	RY	Ø10~ Ø22	
Bending Cut (Left) 左向臥式 成型剪腳	RL	Ø4~ Ø22		Bending Cut (Right) 右向臥式 成型剪腳	RR	Ø4~ Ø22	

● Lead diameter (Ød) and lead pitch (P) are subject to capacitor specifications. ● 引線的直徑(Ød)和腳距(P)請查閱各系列的詳細規格。

^(*) For Radial Lead Type Conductive Polymer Aluminum Solid Capacitors & Radial Lead Type Conductive Polymer Hybrid Aluminum Capacitors only. Please consult with us before you order.
^(*) 僅適用於引線式導電性高分子固態鋁電解電容器及引線式導電性高分子混合型鋁電解電容器。請在訂購前向我們諮詢。

Note: All design and specifications are for reference only and is subject to change without prior notice. If any doubt about safety for your application, please contact us immediately for technical assistance before purchase.
 注：以上所提供的設計及特性參數僅供參考，任何修改不作預先通知。如果在使用上有疑問，請在採購前與我們聯繫，以便提供技術上的協助。

CAT.2023/V2

SOLDERING CONDITIONS 焊接條件

☐ For Chip Type Conductive Polymer Aluminum Solid Electrolytic Capacitors & Chip Type Conductive Polymer Hybrid Aluminum Electrolytic Capacitors 
適用於貼片式導電性高分子固態鋁電解電容器及貼片式導電性高分子混合型鋁電解電容器

■ Recommended Conditions for Reflow Soldering 推薦回流焊條件

● Conductive Polymer Aluminum Solid Electrolytic Capacitors 貼片式導電性高分子固態鋁電解電容器

- (1) Preheating shall be done at +150°C to 200°C and for 60 to 180 seconds.
預熱應在+150°C~200°C 及 60~180 秒內完成。
- (2) The duration for over +230°C temperature at capacitor surface shall not exceed 60 seconds.
電容器表面溫度超過+230°C 的持續時間不得超過 60 秒。
- (3) The standard temperature profile differs by every reflow method.
溫度曲線圖的溫度標準會因回流焊方式的不同而不同。
- (4) Peak temperature +260°C or below: Reflow shall be done 1 cycle only.
峰值溫度在+260°C 或以下：回流焊次數只能是 1 次。
- (5) Peak temperature +250°C or below: Reflow shall be done within 2 cycles.
峰值溫度在+250°C 或以下：回流焊次數最多是 2 次。
- (6) Please make sure that the parts have enough cooling time between the first and second soldering process.
請確保在第 1 次和第 2 次之間的產品有足夠的冷卻時間。
- (7) The temperature at capacitor top shall not exceed the peak temperature.
電容器表面的溫度不得超過峰值溫度。
- (8) Please contact us if your condition is over the maximum.
如使用條件超出最大值，請與我們聯繫。

● Conductive Polymer Hybrid Aluminum Electrolytic Capacitors 貼片式導電性高分子混合型鋁電解電容器

- (1) Preheating shall be done at +150°C to 180°C and for 120 seconds.
預熱應在+150°C~180°C 及 120 秒內完成。
- (2) Peak temperature +260°C or below: Reflow shall be done 1 cycle only.
峰值溫度在+260°C 或以下：回流焊次數只能是 1 次。
- (3) Peak temperature +250°C or below: Reflow shall be done within 2 cycles.
峰值溫度在+250°C 或以下：回流焊次數最多是 2 次。
- (4) Please make sure that the parts have enough cooling time between the first and second soldering process.
請確保在第 1 次和第 2 次之間的產品有足夠的冷卻時間。
- (5) Please contact us if your condition is over the maximum.
如使用條件超出最大值，請與我們聯繫。

■ Classification Reflow Profile 回流焊曲線圖

● Conductive Polymer Aluminum Solid Electrolytic Capacitors 貼片式導電性高分子固態鋁電解電容器

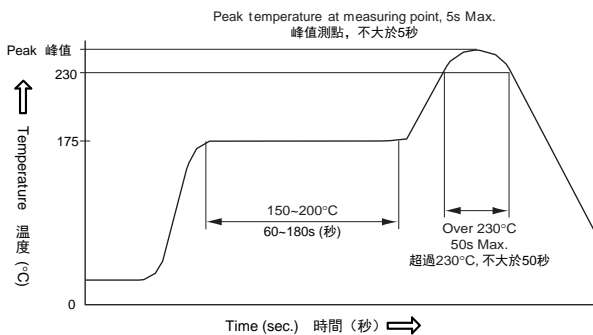

● Conductive Polymer Hybrid Aluminum Electrolytic Capacitors 貼片式導電性高分子混合型鋁電解電容器

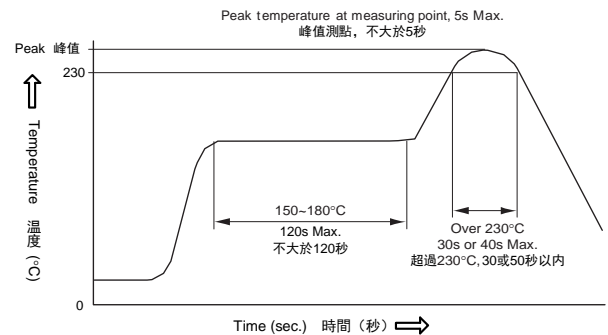

■ Recommended Solder Land Size on PC Board 推薦安裝尺寸 (Unit: mm)

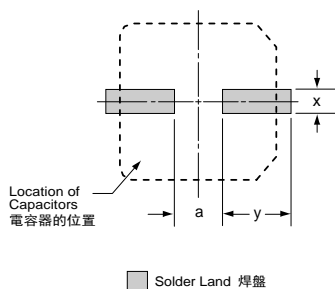

Size 尺寸	a	y	x
Ø4	1.0	2.6	1.6
Ø5	1.4	3.0	1.6
Ø6.3	2.1	3.5	1.6
Ø8 × 6.7~9	2.1	4.0	1.6
Ø8 × 10~12	3.0	3.5	2.5
Ø10	4.0	4.0	2.5
Ø12/12.5	4.0	6.0	3.2
Ø13/13.5	4.0	6.0	3.2

Note: All design and specifications are for reference only and is subject to change without prior notice. If any doubt about safety for your application, please contact us immediately for technical assistance before purchase.

注：以上所提供的設計及特性參數僅供參考，任何修改不作預先通知。如果在使用上有疑問，請在採購前與我們聯繫，以便提供技術上的協助。

CAT.2023/V2

SOLDERING CONDITIONS 焊接條件

☐ For Chip Type Aluminum Electrolytic Capacitors 適用於貼片式鋁電解電容器 

- Radial lead type and snap-in terminal type aluminum electrolytic capacitors please see titled "Mounting" in "General Information for Application".
- 插件式和導箔式鋁電解電容器請查閱“鋁電解電容器使用注意事項”裡的“安裝”說明。

■ Recommended Conditions for Reflow Soldering 推薦回流焊條件

- (1) A thermal condition system such as infrared radiation (IR) or hot blast should be adopted, and vapor heat transfer systems (VPS) are not recommended.
應採用紅外線或熱風回流焊接，而不宜採用汽相加熱回流焊接。
- (2) Reflow soldering should be within 2 cycles. Please make sure that the parts have enough cooling time between the first and second soldering process.
回流焊次數最多 2 次，請確保在第 1 次和第 2 次之間產品有足夠的冷卻時間。
- (3)
 - The time of preheating from 150°C to 180°C shall be within maximum 120 seconds;
從 150°C 到 180°C 的預熱時間應在 120 秒以內；
 - The time of soldering temperature at 217°C measured on capacitors' top shall not exceed t_L (second);
電容器頂部溫度超過 217°C 的焊接時間不得超過 t_L (秒)；
 - The peak temperature on capacitors' top shall not exceed T_p (°C), and the time within 5°C of actual peak temperature shall not exceed t_p (second).
電容器頂部的峰值溫度不得超過 T_p (°C)，在 5°C 範圍內的實際峰值溫度時間不得超過 t_p (秒)。

■ Classification Reflow Profile 回流焊曲線圖

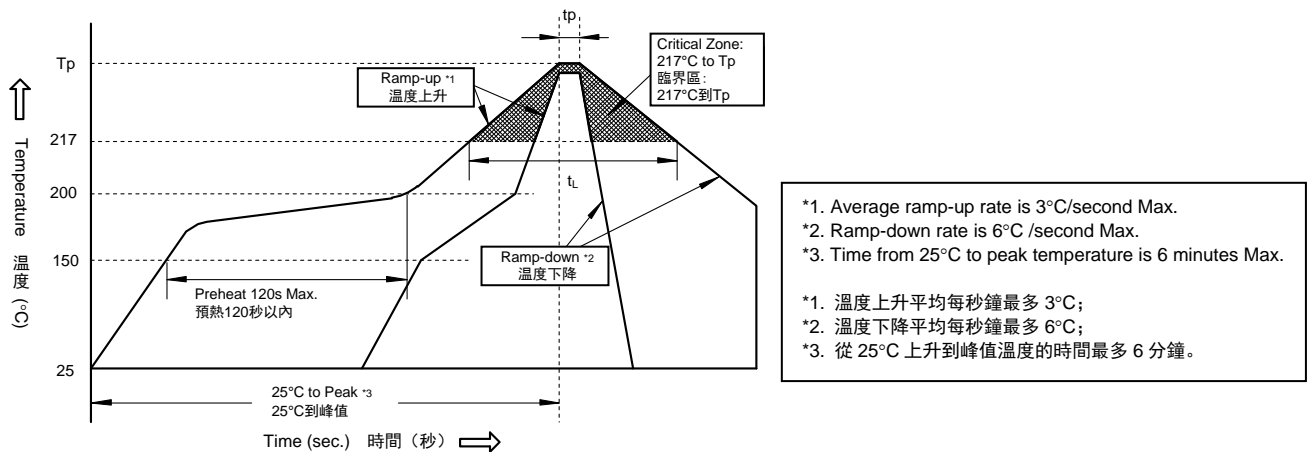

■ Classified at Temperature and Time 溫度和時間分類

Size 尺寸	Preheat 預熱	T_p (°C)	t_L (second 秒)	t_p (second 秒)	Reflow number 回流焊次數
Ø4~Ø6.3, Ø8×6.2	150~180°C 120s Max. (120 秒以內)	255	60	5	2 times or less 最多 2 次
Ø8×10.5		250	60	5	
Ø10		245	60	5	
Ø12.5, Ø16, Ø18		240	40	5	

- Please contact us if your condition is over the maximum.
- 如使用條件超出最大值，請與我們聯繫。

■ Recommended Solder Land Size on PC Board 推薦安裝尺寸 (Unit: mm)

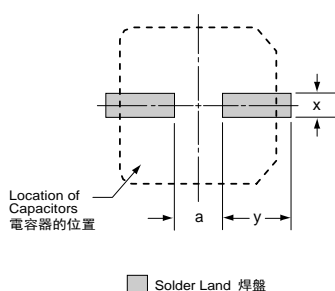

Size 尺寸	a	y	x
Ø4	1.0	2.6	1.6
Ø5	1.4	3.0	1.6
Ø6.3	1.9	3.5	1.6
Ø8 × 6.2	2.1	4.0	1.6
Ø8 × 10.5	3.0	3.5	2.5
Ø10	4.0	4.0	2.5
Ø12.5	4.0	6.0	3.2
Ø16	6.0	7.0	3.2
Ø18	6.0	8.0	3.2

Note: All design and specifications are for reference only and is subject to change without prior notice. If any doubt about safety for your application, please contact us immediately for technical assistance before purchase.

注：以上所提供的設計及特性參數僅供參考，任何修改不作預先通知。如果在使用上有疑問，請在採購前與我們聯繫，以便提供技術上的協助。

CAT.2023/V2

LIFE TIME ESTIMATION OF CAPACITORS 電容器的壽命時間推算

The life of aluminum electrolytic capacitors is mainly dependent on environmental conditions (e.g. ambient temperature, humidity etc.) and electrical factors (e.g. operating temperature, ripple current etc.). Generally, the wear-out mechanism of aluminum electrolytic capacitors is based on evaporation of electrolyte through the rubber seal. Consequently, the factor of temperature (ambient temperature and internal heating due to ripple current) is the most critical to electrolytic capacitors life. The effect of voltage on capacitor life is negligible, especially for low voltage electrolytic capacitors. The lifetime of aluminum electrolytic capacitors can be expressed as following equations:

鋁電解電容器的壽命主要依賴於其適用的環境條件（如環境溫度，濕度等）和電負荷情況（如工作電壓，紋波電流等）。通常而言，鋁電解電容器的失效機理被認為是電解液通過膠塞逐漸揮發所導致。因此，溫度因素（環境溫度和由於紋波電流所引致的內熱）對電容器壽命的影響最大，而電壓對電容器壽命的影響可以忽略，尤其對低電壓鋁電解電容器更是如此。鋁電解電容器的壽命可用下列公式來估算：

$$L_e = L_o \cdot K_t \cdot K_r$$

Where: 其中:

- L_e = Expected life at operating temperature T_e (h) 在工作溫度 T_e (h) 下的預期壽命
- L_o = Specified life at temperature operating temperature T_o (h) 在最大工作溫度 T_o (h) 下的壽命
- K_t = Ambient temperature acceleration term 環境溫度影響因子
- K_r = Ripple current acceleration term 紋波電流影響因子

$$K_t = L_o \cdot A^{(T_o - T_e)/10}$$

Where: 其中:

- T_o = Maximum rated operating temperature (°C) 最大額定工作電壓(°C)
- T_e = Actual ambient temperature (°C) 實際環境適用溫度(°C)
- A = Acceleration coefficient (for the range from 35°C to the maximum operating temperature, A≈2) 加速系數（對於從 35°C 到最高工作溫度的範圍，A≈2）

$$K_r = 2^{(-\Delta T/5)}$$

Where: 其中:

- ΔT = An increase in core temperature by internal heating due to ripple current 由於紋波電流引起的內熱造成電容器芯子的升溫
(ΔT = core temperature – ambient temperature) (ΔT = 芯子溫度 - 環境溫度)

ΔT can be estimated as follows: ΔT 可用以下公式估算:

$$\Delta T = (I^2 \cdot R) / (\beta \cdot S)$$

Where: 其中:

- I = Ripple current of the capacitor (A rms) 通過電容器的紋波電流(A rms)
- R = Equivalent series resistance of the capacitor (Ω) 電容器的等效串聯電阻(Ω)
- β = Heat radiation coefficient of the aluminum can ($W/^\circ C \cdot cm^2$) 鋁殼的熱輻射系數($W/^\circ C \cdot cm^2$)
- S = Surface area of the capacitor (cm^2) 電容器的表面積(cm^2)

In neglecting ripple current effect, the expected life of the capacitors at lower temperature is shown in the following chart. 當忽略紋波電流影響時，電容器在較低溫下的預期壽命可參考以下圖表。

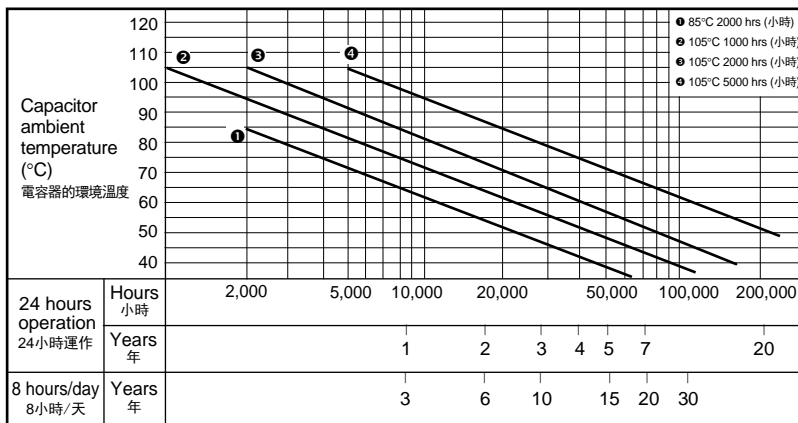

● Quick Reference Guide of the Expected Life 預期壽命快速參考圖

Example 1: When a 2000 hours/105°C guaranteed product is used continuously at 60°C, it can be expected to have a life of 5 years. 例 1：對於 105°C 2000 小時的產品，如果在 60°C 環境中連續使用，它的預期壽命約 5 年。

Example 2: 例 2:

Conductive Polymer Aluminum Solid Electrolytic Capacitors 導電性高分子固態鋁電解電容器	Aluminum Electrolytic Capacitors 鋁電解電容器
105°C ≥ 2,000 hours 小時	105°C ≥ 2,000 hours 小時
95°C ≥ 6,324 hours 小時	95°C ≥ 4,000 hours 小時
85°C ≥ 20,000 hours 小時	85°C ≥ 8,000 hours 小時
75°C ≥ 63,245 hours 小時	75°C ≥ 16,000 hours 小時

Please note that:

- a) The maximum estimated life is 15 years.
- b) Ripple current in application should be less than or equal to ripple current specified in this catalogue.

請留意:

- a) 最大壽命時間約為 15 年。
- b) 施加的紋波電流值應較本目錄所列的紋波值小或等同。

BASIC CONSTRUCTION OF ALUMINUM ELECTROLYTIC CAPACITORS

鋁電解電容器的基本結構

The aluminum electrolytic capacitors contains an internal element of an anode foil, a cathode foil and electrolytic paper rolled together, impregnated with an electrolyte, then attached to external terminals connecting the tabs with the anode or the cathode foils, and sealed in a can case.

鋁電解電容器是由正極與負極鋁箔鉚上正極與負極端子，再和電解紙一起捲繞成芯子，浸漬電解液後用鋁殼封裝而成。

● Internal Structure 內部結構

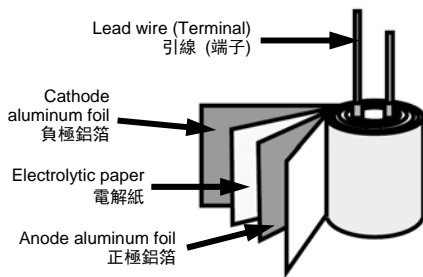

(Basic model of element 芯子基本結構)

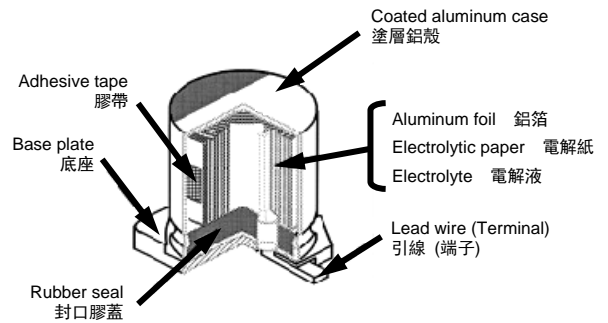

(Chip type 貼片式)

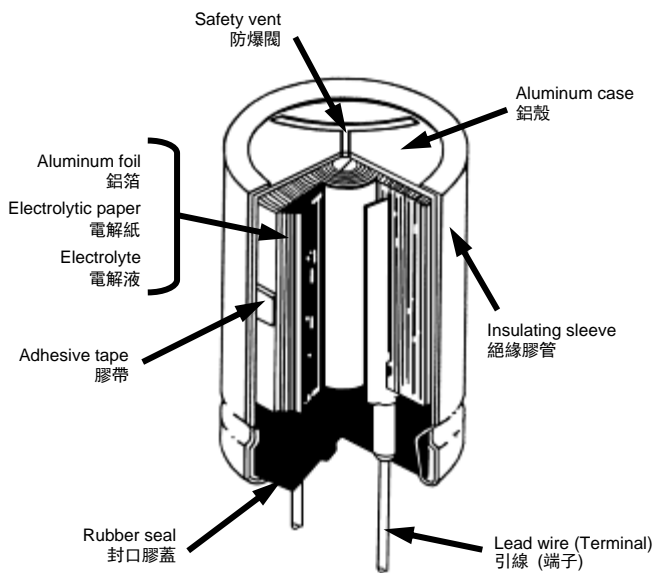

(Radial lead type 引線式)

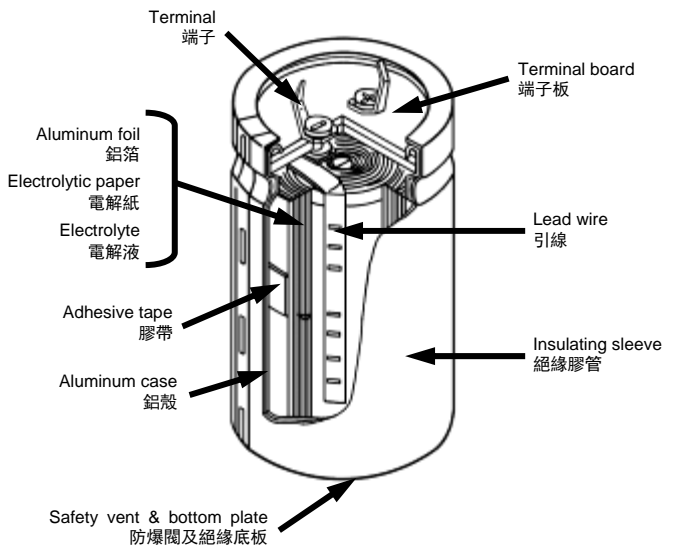

(Snap-in terminal type 導箔式)

Note: All design and specifications are for reference only and is subject to change without prior notice. If any doubt about safety for your application, please contact us immediately for technical assistance before purchase.

注：以上所提供的設計及特性參數僅供參考，任何修改不作預先通知。如果在使用上有疑問，請在採購前與我們聯繫，以便提供技術上的協助。

CORRESPONDING TO RoHS DIRECTIVE 對應RoHS指令

(EU RoHS Directive 2011/65/EU)

Product Name 產品名稱		Conductive Polymer Aluminum Solid Electrolytic Capacitors 導電式高分子固態鋁電解電容器		Conductive Polymer Hybrid Aluminum Electrolytic Capacitors 導電式高分子混合型鋁電解電容器	
Type 類型		Chip type 貼片式	Radial lead type 引線式	Chip type 貼片式	Radial lead type 引線式
RoHS compliant RoHS符合性		Yes 符合	Yes 符合	Yes 符合	Yes 符合
RoHS restricted substances 限制有害物質	The portion of the components 產品的部分特性	Sn plating 鍍錫引線		Sn plating 鍍錫引線	
	Plating on terminals 引線鍍層	Fe/Cu/Sn 鍍錫銅包鐵線		Fe/Cu/Sn 鍍錫銅包鐵線	
Lead (Pb) 鉛	Construction of terminals 引線結構	Fe/Cu/Sn 鍍錫銅包鐵線		Fe/Cu/Sn 鍍錫銅包鐵線	
	Resistance to soldering heat 耐焊接熱	Please refer to page 22 "Soldering Conditions" 請查閱第22頁的“焊接條件”	Correspondence to 265°C wave soldering condition 對應265°C的波峰焊接條件	Please refer to page 22 "Soldering Conditions" 請查閱第22頁的“焊接條件”	Correspondence to 265°C wave soldering condition 對應265°C的波峰焊接條件
	Solderability 可焊性	No difference with Sn-Pb 與鉛錫線相同		No difference with Sn-Pb 與鉛錫線相同	
	Tensile strength 抗拉強度	No difference with Sn-Pb 與鉛錫線相同		No difference with Sn-Pb 與鉛錫線相同	
Hexavalent chromium (Cr VI) 六價鉻		Not detected 未檢出		Not detected 未檢出	
Mercury (Hg) 汞					
Cadmium (Cd) 鎘					
PBBs 多溴聯苯					
PBDEs 多溴二苯醚					
HBDD 六溴環十二烷					
DBP 鄰苯二甲酸二丁酯					
BBP 鄰苯二甲酸丁苄酯					
DEHP 鄰苯二甲酸雙(2-乙基己)酯					
Identification for RoHS compliance products RoHS符合性產品的識別					
MSL Level 濕度敏感水平 (IPC/JEDEC J-STD-020C)		Not applicable 不適用		Not applicable 不適用	

Aluminum Electrolytic Capacitors 鋁電解電容器		Chip type 貼片式	Radial lead type 引線式	Snap-in terminal type 導管式
RoHS compliant RoHS符合性		Yes 符合	Yes 符合	Yes 符合
RoHS restricted substances 限制有害物質	The portion of the components 產品的部分特性	Change plating from Sn-Pb to Sn 將鍍鉛錫合金變更為鍍錫		
	Plating on terminals 引線鍍層	Fe/Cu/Sn 鍍錫銅包鐵線		
Lead (Pb) 鉛	Construction of terminals 引線結構	<ul style="list-style-type: none"> Plating thickness 12µm Plating type matte No heat treatment after plating 鍍錫層厚度12µm 鍍錫層類型不光滑 鍍錫後無熱處理 		<ul style="list-style-type: none"> Plating thickness 10µm Plating type matte No heat treatment after plating 鍍錫層厚度10µm 鍍錫層類型不光滑 鍍錫後無熱處理
	Insulating sleeve 膠管	No used 不使用		Replace PVC with PET (where customer designated) 將PVC更換為PET (若客戶指定)
	Resistance to soldering heat 耐焊接熱	Please refer to page 23 "Soldering Conditions" 請查閱第23頁的“焊接條件”		Correspondence to 260°C wave soldering condition 對應260°C的波峰焊接條件
	Solderability 可焊性	No difference with Sn-Pb 與鉛錫線相同		
	Tensile strength 抗拉強度	No difference with Sn-Pb 與鉛錫線相同		
Hexavalent chromium (Cr VI) 六價鉻		Not detected 未檢出		
Mercury (Hg) 汞				
Cadmium (Cd) 鎘				
PBBs 多溴聯苯				
PBDEs 多溴二苯醚				
HBDD 六溴環十二烷				
DBP 鄰苯二甲酸二丁酯				
BBP 鄰苯二甲酸丁苄酯				
DEHP 鄰苯二甲酸雙(2-乙基己)酯				
Identification for RoHS compliance products RoHS符合性產品的識別				
MSL Level 濕度敏感水平 (IPC/JEDEC J-STD-020C)		Not applicable 不適用		

Note: All design and specifications are for reference only and is subject to change without prior notice. If any doubt about safety for your application, please contact us immediately for technical assistance before purchase.

注: 以上所提供的設計及特性參數僅供參考, 任何修改不作預先通知。如果在使用上有疑問, 請在採購前與我們聯繫, 以便提供技術上的協助。

CAT.2023/V2

ECO-FRIENDLY PRODUCTS 親環境產品

All our aluminum electrolytic capacitors are Lead-free and RoHS compliant. We can also provide Halogen-free products for your requirement. 所有的鋁電解電容器產品屬於無鉛及符合歐盟 RoHS 指令，我們也可按您的要求提供無鹵產品。

■ Non-PVC and Sleeveless Products 不含PVC及無膠管產品

Product Type 產品類型	Sleeve Material 膠管材質
Chip type 貼片式	Sleeveless (Coating case) 無膠管 (鍍層鋁殼)
Radial lead type (≤∅18mm)* 引線式 (≤∅18mm)*	Sleeveless (Coating case)* 無膠管 (鍍層鋁殼)*
Radial lead type 引線式	PET (Polyethylene Terephthalate) PET (聚對苯二甲酸乙二酯)
Snap-in terminal type 導箔式	PET (Polyethylene Terephthalate) PET (聚對苯二甲酸乙二酯)

*Please consult with our sales office when you need "Sleeveless Parts".

*如有需要“無膠管產品”，請與我們業務部門聯繫。

- The colour of PET sleeve are Green, Purple Blue, Yellow, Black, Light Purple and Brown (for radial lead and snap-in terminal type).
- Identification of eco-friendly parts is given by a supplement code (15th digit) of the part number (for radial lead and snap-in terminal type).
- For detail, please refer to "Explanation of Part Numbers" for each type.

- PET 膠管的顏色為綠色、藍紫色、黃色、黑色、淺紫色和褐色（適用於引線式及導箔式）。
- 親環境產品的識別是通過產品編碼的第 15 位代碼來區分（適用於引線式及導箔式）。
- 詳細說明請查閱“產品編碼規則”。

COMPLIANCE FOR EU REACH REGULATION 遵循歐盟REACH法規

[EU REACH Regulation (EC) 1907/2006]

- 1) Registration of Substance:
According to the content of REACH handbook (Guidance on requirements of substances in articles which is published on May 2008), our products are "articles without any intended release". Therefore they are not applicable for "Registration" for EU REACH Regulation Article 7(1).
- 2) Correspondence with SVHC (Substances of Very High Concern):
Per the candidate list of SVHC-234 (Substances of Very High Concern) published January 2023, we have reviewed these substances and certify all Fujicon products are not intentionally used, no exposure of this material to humans.

■ For any questions or comments regarding REACH, please contact our sales office.

- 1) 物質的註冊：
根據 REACH 法規手冊內容（2008 年 5 月公佈的物品中物質的要求），我們的產品是“沒有任何有意釋放的物品”。因此，我們的產品不適用於歐盟 REACH 法規的第 7(1) 條的“註冊”。
- 2) 對應 SVHC（高度關注物質）：
對於 2023 年 1 月公佈的 SVHC-234（高關注物質）的候選清單，我們已審閱這些物質並證明我們的產品並無使用，以及此材料不暴露於人體。

■ 如對 REACH 有任何問題和意見，請與我們業務部門聯繫。

<p>Contact our sales office for the following additional information:</p> <ul style="list-style-type: none"> ● RoHS test reports ● REACH test reports ● PAHS/Halogen test reports ● Phthalates content test reports ● Material Safety Data Sheets (MSDS) 	<p>如有需要，請聯繫我們業務部門獲取以下附加訊息：</p> <ul style="list-style-type: none"> ● RoHS 測試報告 ● REACH 測試報告 ● PAHS/鹵素測試報告 ● 鄰苯二甲酸鹽測試報告 ● 物質安全資料表 (MSDS)
---	---

Note: All design and specifications are for reference only and is subject to change without prior notice. If any doubt about safety for your application, please contact us immediately for technical assistance before purchase.

注：以上所提供的設計及特性參數僅供參考，任何修改不作預先通知。如果在使用上有疑問，請在採購前與我們聯繫，以便提供技術上的協助。

CAT.2023/V2

CASE SIZES AND WEIGHT RANGE 產品尺寸與重量

■ Chip Type Aluminum Electrolytic Capacitors 貼片式鋁電解電容器

Diameter × L (mm) 直徑 × 高度	Approx. Weight (g) 大約重量	Diameter × L (mm) 直徑 × 高度	Approx. Weight (g) 大約重量
4 × 5.4/5.8	0.23	10 × 13.5	1.85
5 × 5.4/5.8	0.37	12.5 × 13.5	2.49
6.3 × 5.4/5.8	0.49	12.5 × 16	2.87
6.3 × 7.7	0.59	16 × 16.5	5.50
8 × 10.5	1.37	18 × 16.5	8.00
10 × 10.5	1.70	18 × 18.5	9.10

■ Radial Lead Type Aluminum Electrolytic Capacitors 引線式鋁電解電容器

Diameter × L (mm) 直徑 × 高度	Approx. Weight (g) 大約重量	Diameter × L (mm) 直徑 × 高度	Approx. Weight (g) 大約重量	Diameter × L (mm) 直徑 × 高度	Approx. Weight (g) 大約重量
3 × 5	0.12	6.3 × 15	0.82	16 × 25	7.50
4 × 5	0.19	8 × 11.5	1.08	16 × 31	7.80
5 × 5	0.25	8 × 16	1.36	16 × 35	9.20
6.3 × 5	0.35	8 × 20	1.77	16 × 40	10.80
8 × 5	0.53	10 × 12	1.61	18 × 20	8.00
4 × 7	0.23	10 × 16	2.10	18 × 25	9.00
5 × 7	0.32	10 × 20	2.56	18 × 31	11.00
6.3 × 7	0.46	10 × 25	2.98	18 × 35	13.00
8 × 7	0.65	10 × 30	3.78	18 × 40	16.00
8 × 9	0.75	13 × 21	3.93	22 × 35	22.50
5 × 11	0.44	13 × 25	4.90	22 × 40	24.00
5 × 15	0.54	13 × 30	5.83	25 × 40	30.00
6.3 × 11.5	0.65	16 × 20	6.50		

■ Snap-in Terminal Type Aluminum Electrolytic Capacitors 導箔式鋁電解電容器

Diameter × L (mm) 直徑 × 高度	Approx. Weight (g) 大約重量	Diameter × L (mm) 直徑 × 高度	Approx. Weight (g) 大約重量	Diameter × L (mm) 直徑 × 高度	Approx. Weight (g) 大約重量
22 × 25	9	25 × 45	25	30 × 60	79
22 × 30	12	25 × 50	29	35 × 20	19
22 × 35	15	25 × 55	32	35 × 25	22
22 × 40	18	30 × 20	14	35 × 30	29
22 × 45	20	30 × 25	17	35 × 35	36
22 × 50	24	30 × 30	23	35 × 40	41
25 × 25	13	30 × 35	29	35 × 45	56
25 × 30	17	30 × 40	36	35 × 50	70
25 × 35	19	30 × 45	41	35 × 55	81
25 × 40	22	30 × 50	46	35 × 60	92

- There are some differences between actual weight, above information is for reference only.
- 以上的重量信息與實際重量會有差異，僅供參考。

Note: All design and specifications are for reference only and is subject to change without prior notice. If any doubt about safety for your application, please contact us immediately for technical assistance before purchase.

注：以上所提供的設計及特性參數僅供參考，任何修改不作預先通知。如果在使用上有疑問，請在採購前與我們聯繫，以便提供技術上的協助。

CAT.2023/V2

Conductive Polymer Aluminum Solid Electrolytic Capacitors (Chip & Radial Lead Type)
導電性高分子固態鋁電解電容器 (貼片式及引線式)



Note: All design and specifications are for reference only and is subject to change without prior notice. If any doubt about safety for your application, please contact us immediately for technical assistance before purchase.

注：以上所提供的設計及特性參數僅供參考，任何修改不作預先通知。如果在使用上有疑問，請在採購前與我們聯繫，以便提供技術上的協助。

CAT.2023/V2

MA Series

CHIP TYPE, STANDARD

貼片式, 標準品

- Operating with wide temperature range -55~+105°C
適用於 -55~+105°C 的寬溫範圍
- Low ESR, high ripple current
低阻抗, 高紋波電流
- Endurance 2000 hours
耐久性 2000 小時
- RoHS & REACH compliant, Halogen-free
符合 RoHS 與 REACH, 無鹵

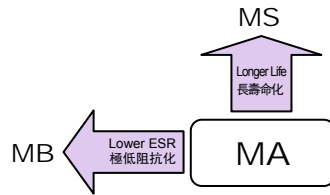

□ SPECIFICATIONS 特性表

Items 項目	Characteristics 主要特性								
Category Temperature Range 工作溫度範圍	-55 ~ +105°C								
Voltage Range 額定工作電壓範圍	2.5 ~ 25V								
Capacitance Range 靜電容量範圍	3.3 ~ 1500µF								
Capacitance Tolerance 靜電容量允許偏差	±20% at 120Hz, 20°C								
Leakage Current 漏電流 (*1)	≤Specified value (after 2 minutes application of rated voltage at 20°C). ≤規範值 (在 20°C 環境中施加額定工作電壓 2 分鐘後)。								
Dissipation Factor (tan δ) 損耗角正切	≤Specified value at 120Hz, 20°C. ≤規範值 (在 20°C 120Hz 環境下)。								
ESR 阻抗值 (*2)	≤Specified value at 100KHz, 20°C. ≤規範值 (在 20°C 100KHz 環境下)。								
Stability at Low Temperature 低溫特性	Measurement frequency 測試頻率: 100KHz <table border="1"> <tr> <td>Impedance Ratio 阻抗比 ZT/Z20 (max.)</td> <td>Z(+105°C)/Z(20°C)</td> <td>≤1.25</td> </tr> <tr> <td></td> <td>Z(-55°C)/Z(20°C)</td> <td>≤1.25</td> </tr> </table>	Impedance Ratio 阻抗比 ZT/Z20 (max.)	Z(+105°C)/Z(20°C)	≤1.25		Z(-55°C)/Z(20°C)	≤1.25		
Impedance Ratio 阻抗比 ZT/Z20 (max.)	Z(+105°C)/Z(20°C)	≤1.25							
	Z(-55°C)/Z(20°C)	≤1.25							
Damp Heat (Steady State) 穩態濕熱	When the capacitors are restored to 20°C after the rated voltage is applied for 1000 hours at 60°C, 90% RH, they meet the characteristics listed below. 在 60°C 和相對濕度 90% 環境下施加額定工作電壓 1000 小時並冷卻至 20°C 後, 電容器的特性符合下表的要求。 <table border="1"> <tr> <td>Capacitance Change 靜電容量變化率</td> <td>Within ±20% of initial value 為初始值的±20%以內 (*3)</td> </tr> <tr> <td>Dissipation Factor 損耗角正切</td> <td>150% or less of initial specified value 不大於規範值的 150%</td> </tr> <tr> <td>ESR 阻抗值 (*2)</td> <td>150% or less of initial specified value 不大於規範值的 150%</td> </tr> <tr> <td>Leakage Current 漏電流</td> <td>Initial specified value or less 不大於規範值</td> </tr> </table>	Capacitance Change 靜電容量變化率	Within ±20% of initial value 為初始值的±20%以內 (*3)	Dissipation Factor 損耗角正切	150% or less of initial specified value 不大於規範值的 150%	ESR 阻抗值 (*2)	150% or less of initial specified value 不大於規範值的 150%	Leakage Current 漏電流	Initial specified value or less 不大於規範值
Capacitance Change 靜電容量變化率	Within ±20% of initial value 為初始值的±20%以內 (*3)								
Dissipation Factor 損耗角正切	150% or less of initial specified value 不大於規範值的 150%								
ESR 阻抗值 (*2)	150% or less of initial specified value 不大於規範值的 150%								
Leakage Current 漏電流	Initial specified value or less 不大於規範值								
Endurance 耐久性	After 2000 hours application of the rated voltage at 105°C, they meet the characteristics listed below. 在 105°C 環境中施加額定工作電壓 2000 小時後, 電容器的特性符合下表的要求。 <table border="1"> <tr> <td>Capacitance Change 靜電容量變化率</td> <td>Within ±20% of initial value 為初始值的±20%以內 (*3)</td> </tr> <tr> <td>Dissipation Factor 損耗角正切</td> <td>150% or less of initial specified value 不大於規範值的 150%</td> </tr> <tr> <td>ESR 阻抗值 (*2)</td> <td>150% or less of initial specified value 不大於規範值的 150%</td> </tr> <tr> <td>Leakage Current 漏電流</td> <td>Initial specified value or less 不大於規範值</td> </tr> </table>	Capacitance Change 靜電容量變化率	Within ±20% of initial value 為初始值的±20%以內 (*3)	Dissipation Factor 損耗角正切	150% or less of initial specified value 不大於規範值的 150%	ESR 阻抗值 (*2)	150% or less of initial specified value 不大於規範值的 150%	Leakage Current 漏電流	Initial specified value or less 不大於規範值
Capacitance Change 靜電容量變化率	Within ±20% of initial value 為初始值的±20%以內 (*3)								
Dissipation Factor 損耗角正切	150% or less of initial specified value 不大於規範值的 150%								
ESR 阻抗值 (*2)	150% or less of initial specified value 不大於規範值的 150%								
Leakage Current 漏電流	Initial specified value or less 不大於規範值								
Resistance to Soldering Heat 耐焊接熱特性 (Please refer page 22 for soldering conditions) (焊接條件請查閱第 22 頁)	After reflow soldering and restored at room temperature, they meet the characteristics listed below. 經過回流焊並冷卻至室溫後, 電容器的特性符合下表的要求。 <table border="1"> <tr> <td>Capacitance Change 靜電容量變化率</td> <td>Within ±10% of initial value 初始值的±10%以內 (*3)</td> </tr> <tr> <td>Dissipation Factor 損耗角正切</td> <td>130% or less of initial specified value 不大於規範值的 130%</td> </tr> <tr> <td>ESR 阻抗值 (*2)</td> <td>130% or less of initial specified value 不大於規範值的 130%</td> </tr> <tr> <td>Leakage Current 漏電流</td> <td>Initial specified value or less 不大於規範值</td> </tr> </table>	Capacitance Change 靜電容量變化率	Within ±10% of initial value 初始值的±10%以內 (*3)	Dissipation Factor 損耗角正切	130% or less of initial specified value 不大於規範值的 130%	ESR 阻抗值 (*2)	130% or less of initial specified value 不大於規範值的 130%	Leakage Current 漏電流	Initial specified value or less 不大於規範值
Capacitance Change 靜電容量變化率	Within ±10% of initial value 初始值的±10%以內 (*3)								
Dissipation Factor 損耗角正切	130% or less of initial specified value 不大於規範值的 130%								
ESR 阻抗值 (*2)	130% or less of initial specified value 不大於規範值的 130%								
Leakage Current 漏電流	Initial specified value or less 不大於規範值								
Marking 標識	Red print on the case top. 鋁殼頂部紅色字體印刷。								

(*1) If any doubt arises, measure the leakage current after the voltage treatment of applying DC rated voltage continuously to the capacitor for 120 minutes at 105°C.

如未能確定, 在 105°C 環境下連續施加額定工作電壓 120 分鐘後測量漏電流。

(*2) Should be measured at both of the terminal ends closest where the terminals protrude through the plastic platform.

測試應為靠近突出底座兩個端子的末端。

(*3) The value before test of examination of resistance to soldering.

焊接測試前的值。

□ DRAWING 外形圖 (Unit: mm)

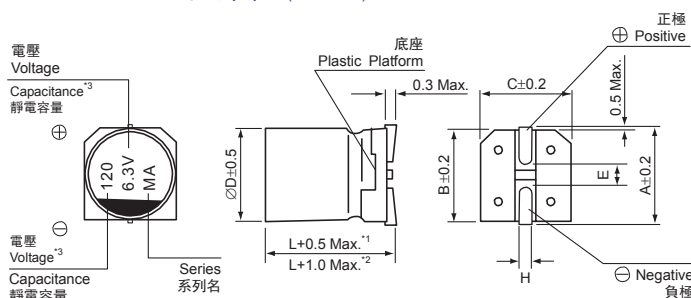

- *1. Applicable to Ø4~Ø8
- *2. Applicable to Ø10 and above
- *3. Capacitance ≥1000µF

適用於Ø4~Ø8
適用於Ø10和Ø10以上
容量≥1000µF

Dimension table in next page.
尺寸表見下一頁。

Note: All design and specifications are for reference only and is subject to change without prior notice. If any doubt about safety for your application, please contact us immediately for technical assistance before purchase.

注: 以上所提供的設計及特性參數僅供參考, 任何修改不作預先通知。如果在使用上有疑問, 請在採購前與我們聯繫, 以便提供技術上的協助。

CAT.2023/V2

MA Series

□ DIMENSIONS 尺寸表 (Unit: mm)

∅D × L	4 × 5.5	5 × 6	6.3 × 5.5/6	8 × 7	8 × 12	10 × 8/10	10 × 12.7
A	5.0	6.0	7.3	9.0	9.0	11.0	11.0
B	4.3	5.3	6.6	8.3	8.3	10.3	10.3
C	4.3	5.3	6.6	8.3	8.3	10.3	10.3
E	1.0	1.6	2.1	3.2	3.2	4.6	4.6
L	5.5	6.0	5.5/6.0	7.0	12.0	8.0/10.0	12.7
H	0.5~0.8	0.5~0.8	0.5~0.8	0.8~1.1	0.8~1.1	0.8~1.1	0.8~1.1

□ DIMENSIONS & STANDARD RATINGS 規格尺寸及標準參數

WV (V)		2.5 (0E)					4 (0G)				
Cap. 容量 (μF)	Parameter 參數	Case size ∅D×L (mm) 尺寸	Dissipation factor (tan δ) 損耗角正切	Leakage current (μA) 漏電流	ESR (mΩ) max. 20°C, 100KHz 阻抗值	Ripple current (mA rms) 105°C, 100KHz 紋波電流	Case size ∅D×L (mm) 尺寸	Dissipation factor (tan δ) 損耗角正切	Leakage current (μA) 漏電流	ESR (mΩ) max. 20°C, 100KHz 阻抗值	Ripple current (mA rms) 105°C, 100KHz 紋波電流
		33	330						4 × 5.5	0.12	26.4
100	101	6.3 × 6	0.12	50	22	2600	6.3 × 5.5 (6.3 × 6)	0.12 (0.12)	80 (80)	22 (22)	2600 (2600)
150	151						6.3 × 5.5 (5 × 6) (6.3 × 6)	0.12 (0.12) (0.12)	120 (120) (120)	22 (30) (22)	2800 (2000) (2800)
220	221	6.3 × 5.5 (6.3 × 6)	0.12 (0.12)	110 (110)	20 (20)	2800 (2800)	8 × 7	0.12	176	21	3200
330	331						8 × 7	0.12	264	21	3400
470	471	8 × 7	0.12	235	20	3300	10 × 8	0.12	376	17	4200
560	561						8 × 12	0.12	448	13	4520
680	681						10 × 8	0.12	544	17	4400
820	821	10 × 8	0.12	410	17	4400	10 × 10	0.12	656	13	4800
1200	122						10 × 12.7	0.12	960	10	5500
1500	152	10 × 10 (10 × 12.7)	0.12 (0.12)	750 (750)	13 (12)	4700 (5440)					

WV (V)		6.3 (0J)					10 (1A)				
Cap. 容量 (μF)	Parameter 參數	Case size ∅D×L (mm) 尺寸	Dissipation factor (tan δ) 損耗角正切	Leakage current (μA) 漏電流	ESR (mΩ) max. 20°C, 100KHz 阻抗值	Ripple current (mA rms) 105°C, 100KHz 紋波電流	Case size ∅D×L (mm) 尺寸	Dissipation factor (tan δ) 損耗角正切	Leakage current (μA) 漏電流	ESR (mΩ) max. 20°C, 100KHz 阻抗值	Ripple current (mA rms) 105°C, 100KHz 紋波電流
		4.7	4R7						4 × 5.5	0.12	9.4
6.8	6R8						4 × 5.5	0.12	13.6	240	670
10	100						4 × 5.5	0.12	30	220	700
15	150						4 × 5.5	0.12	44	200	700
22	220	4 × 5.5	0.12	27.72	200	700					
33	330						5 × 6	0.12	66	35	1500
47	470	5 × 6	0.12	59.22	35	1600	5 × 6 (6.3 × 6)	0.12 (0.12)	94 (94)	26 (26)	2600 (2600)
56	560						6.3 × 5.5 (6.3 × 6)	0.12 (0.12)	112 (112)	25 (25)	2500 (2500)
82	820	6.3 × 5.5 (6.3 × 6)	0.12 (0.12)	103 (103)	23 (23)	2600 (2600)					
100	101	6.3 × 5.5 (5 × 6) (6.3 × 6)	0.12 (0.12) (0.12)	126 (126) (126)	23 (25) (23)	2800 (2200) (2800)					
120	121	6.3 × 6	0.12	151	23	3000	8 × 7	0.12	240	23	3000
150	151	8 × 7	0.12	189	22	3200	8 × 7 (10 × 8)	0.12 (0.12)	300 (300)	23 (21)	3200 (3300)
220	221	6.3 × 6.5 (8 × 7)	0.12 (0.12)	277 (277)	22 (22)	3200 (3400)					
270	271						8 × 12 (10 × 8)	0.12 (0.12)	540 (540)	13 (20)	4500 (3600)
330	331	10 × 8	0.12	416	18	4200	8 × 12 (10 × 8)	0.12 (0.12)	660 (660)	14 (20)	4000 (3700)
470	471	8 × 12 (10 × 8) (10 × 10)	0.12 (0.12) (0.12)	592 (592) (592)	12 (18) (16)	5300 (4300) (4600)	10 × 10 (10 × 12.7)	0.12 (0.12)	940 (940)	16 (12)	4600 (5300)
560	561						10 × 10 (10 × 12.7)	0.12 (0.12)	1120 (1120)	15 (13)	4800 (5230)
680	681	10 × 10 (10 × 12.7)	0.12 (0.12)	857 (857)	14 (10)	5000 (5500)					
820	821	10 × 12.7	0.12	1033	10	5800	10 × 10	0.12	1640	15	5300

Note: All design and specifications are for reference only and is subject to change without prior notice. If any doubt about safety for your application, please contact us immediately for technical assistance before purchase.

注：以上所提供的設計及特性參數僅供參考，任何修改不作預先通知。如果在使用上有疑問，請在採購前與我們聯繫，以便提供技術上的協助。

CAT.2023/V2

MA Series

□ DIMENSIONS & STANDARD RATINGS 規格尺寸及標準參數

WV (V)		16 (1C)					20 (1D)				
Cap. 容量 (μF)	Parameter 參數	Case size ∅D×L (mm) 尺寸	Dissipation factor (tan δ) 損耗角正切	Leakage current (μA) 漏電流	ESR (mΩ) max. 20°C, 100KHz 阻抗值	Ripple current (mA rms) 105°C, 100KHz 紋波電流	Case size ∅D×L (mm) 尺寸	Dissipation factor (tan δ) 損耗角正切	Leakage current (μA) 漏電流	ESR (mΩ) max. 20°C, 100KHz 阻抗值	Ripple current (mA rms) 105°C, 100KHz 紋波電流
3.3	3R3	4 × 5.5	0.12	10.56	260	660					
10	100						4 × 5.5	0.12	40	120	900
22	220	5 × 6	0.12	70.4	45	1210	6.3 × 5.5 (6.3 × 6)	0.12 (0.12)	88 (88)	50 (50)	1700 (1700)
33	330	6.3 × 6	0.12	106	31	2400					
39	390	6.3 × 5.5 (6.3 × 6)	0.12 (0.12)	125 (125)	31 (31)	2400 (2400)	8 × 7	0.12	156	45	2000
47	470						8 × 7	0.12	188	45	2000
56	560	8 × 7	0.12	179	30	2900	10 × 8	0.12	224	40	2400
68	680						10 × 8	0.12	272	40	2600
82	820	8 × 7	0.12	262	28	3200	10 × 8	0.12	328	40	2600
100	101	10 × 8	0.12	320	27	3300	8 × 12	0.12	400	22	3200
120	121						10 × 10	0.12	480	35	2800
150	151	10 × 8 (6.3 × 6.5)	0.12 (0.12)	480 (480)	25 (30)	3500 (2900)	10 × 12.7	0.12	600	20	4320
180	181	8 × 12 (10 × 8)	0.12 (0.12)	576 (576)	16 (25)	4400 (3600)					
220	221	10 × 10 (10 × 12.7)	0.12 (0.12)	704 (704)	20 (14)	3900 (5050)					
330	331	10 × 12.7	0.12	1056	14	5000					

WV (V)		25 (1E)				
Cap. 容量 (μF)	Parameter 參數	Case size ∅D×L (mm) 尺寸	Dissipation factor (tan δ) 損耗角正切	Leakage current (μA) 漏電流	ESR (mΩ) max. 20°C, 100KHz 阻抗值	Ripple current (mA rms) 105°C, 100KHz 紋波電流
6.8	6R8	6.3 × 6	0.12	34	80	1200
10	100	8 × 7	0.12	50	60	1600
22	220	10 × 8	0.12	110	50	2200
33	330	8 × 12	0.12	165	30	2800
47	470	6.3 × 6 (8 × 12)	0.12 (0.12)	235 (235)	50 (30)	2000 (3000)
56	560	10 × 12.7	0.12	280	28	3800
100	101	8 × 7	0.12	500	25	3000

- Taping specifications are given in page 17. 編帶標準請查閱第 17 頁。
- Soldering conditions and recommended land size are given in page 22. 焊接條件及推薦安裝尺寸請查閱第 22 頁。
- Please refer to page 18 for the minimum package quantity. 最小包裝數量請查閱第 18 頁。
- Please refer to page 14 for the Part Number System. 產品編碼規則請查閱第 14 頁。

Note: All design and specifications are for reference only and is subject to change without prior notice. If any doubt about safety for your application, please contact us immediately for technical assistance before purchase.

注：以上所提供的設計及特性參數僅供參考，任何修改不作預先通知。如果在使用上有疑問，請在採購前與我們聯繫，以便提供技術上的協助。

CAT.2023/V2

MB Series

CHIP TYPE, HIGHER CAPACITANCE

貼片式，大容量品



- Operating with wide temperature range -55~+105°C
適用於 -55~+105°C 的寬溫範圍
- Higher capacitance, ultra-low ESR, high ripple current
更大容量，極低阻抗，高紋波電流
- Endurance 2000 hours
耐久性 2000 小時
- RoHS & REACH compliant, Halogen-free
符合 RoHS 與 REACH，無鹵

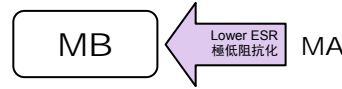

□ SPECIFICATIONS 特性表

Items 項目	Characteristics 主要特性								
Category Temperature Range 工作溫度範圍	-55 ~ +105°C								
Voltage Range 額定工作電壓範圍	2.5 ~ 18V								
Capacitance Range 靜電容量範圍	56 ~ 2200µF								
Capacitance Tolerance 靜電容量允許偏差	±20% at 120Hz, 20°C								
Leakage Current 漏電流 (*1)	≤Specified value (after 2 minutes application of rated voltage at 20°C). ≤規範值(在 20°C 環境中施加額定工作電壓 2 分鐘後)。								
Dissipation Factor (tan δ) 損耗角正切	≤Specified value at 120Hz, 20°C. ≤規範值(在 20°C 120Hz 環境下)。								
ESR 阻抗值 (*2)	≤Specified value at 100KHz, 20°C. ≤規範值(在 20°C 100KHz 環境下)。								
Stability at Low Temperature 低溫特性	Measurement frequency 測試頻率: 100KHz <table border="1"> <tr> <td>Impedance Ratio 阻抗比 ZT/Z20 (max.)</td> <td>Z(+105°C)/Z(20°C) Z(-55°C)/Z(20°C)</td> <td>≤1.25 ≤1.25</td> </tr> </table>	Impedance Ratio 阻抗比 ZT/Z20 (max.)	Z(+105°C)/Z(20°C) Z(-55°C)/Z(20°C)	≤1.25 ≤1.25					
Impedance Ratio 阻抗比 ZT/Z20 (max.)	Z(+105°C)/Z(20°C) Z(-55°C)/Z(20°C)	≤1.25 ≤1.25							
Damp Heat (Steady State) 穩態濕熱	When the capacitors are restored to 20°C after the rated voltage is applied for 1000 hours at 60°C, 90% RH, they meet the characteristics listed below. 在 60°C 和相對濕度 90%環境下施加額定工作電壓 1000 小時並冷卻至 20°C 後，電容器的特性符合下表的要求。 <table border="1"> <tr> <td>Capacitance Change 靜電容量變化率</td> <td>Within ±20% of initial value 為初始值的±20%以內 (*3)</td> </tr> <tr> <td>Dissipation Factor 損耗角正切</td> <td>150% or less of initial specified value 不大於規範值的 150%</td> </tr> <tr> <td>ESR 阻抗值 (*2)</td> <td>150% or less of initial specified value 不大於規範值的 150%</td> </tr> <tr> <td>Leakage Current 漏電流</td> <td>Initial specified value or less 不大於規範值</td> </tr> </table>	Capacitance Change 靜電容量變化率	Within ±20% of initial value 為初始值的±20%以內 (*3)	Dissipation Factor 損耗角正切	150% or less of initial specified value 不大於規範值的 150%	ESR 阻抗值 (*2)	150% or less of initial specified value 不大於規範值的 150%	Leakage Current 漏電流	Initial specified value or less 不大於規範值
Capacitance Change 靜電容量變化率	Within ±20% of initial value 為初始值的±20%以內 (*3)								
Dissipation Factor 損耗角正切	150% or less of initial specified value 不大於規範值的 150%								
ESR 阻抗值 (*2)	150% or less of initial specified value 不大於規範值的 150%								
Leakage Current 漏電流	Initial specified value or less 不大於規範值								
Endurance 耐久性	After 2000 hours application of the rated voltage at 105°C, they meet the characteristics listed below. 在 105°C 環境中施加額定工作電壓 2000 小時後，電容器的特性符合下表的要求。 <table border="1"> <tr> <td>Capacitance Change 靜電容量變化率</td> <td>Within ±20% of initial value 為初始值的±20%以內 (*3)</td> </tr> <tr> <td>Dissipation Factor 損耗角正切</td> <td>150% or less of initial specified value 不大於規範值的 150%</td> </tr> <tr> <td>ESR 阻抗值 (*2)</td> <td>150% or less of initial specified value 不大於規範值的 150%</td> </tr> <tr> <td>Leakage Current 漏電流</td> <td>Initial specified value or less 不大於規範值</td> </tr> </table>	Capacitance Change 靜電容量變化率	Within ±20% of initial value 為初始值的±20%以內 (*3)	Dissipation Factor 損耗角正切	150% or less of initial specified value 不大於規範值的 150%	ESR 阻抗值 (*2)	150% or less of initial specified value 不大於規範值的 150%	Leakage Current 漏電流	Initial specified value or less 不大於規範值
Capacitance Change 靜電容量變化率	Within ±20% of initial value 為初始值的±20%以內 (*3)								
Dissipation Factor 損耗角正切	150% or less of initial specified value 不大於規範值的 150%								
ESR 阻抗值 (*2)	150% or less of initial specified value 不大於規範值的 150%								
Leakage Current 漏電流	Initial specified value or less 不大於規範值								
Resistance to Soldering Heat 耐焊接熱特性 (Please refer page 22 for soldering conditions) (焊接條件請查閱第 22 頁)	After reflow soldering and restored at room temperature, they meet the characteristics listed below. 經過回流焊並冷卻至室溫後，電容器的特性符合下表的要求。 <table border="1"> <tr> <td>Capacitance Change 靜電容量變化率</td> <td>Within ±10% of initial value 初始值的±10%以內 (*3)</td> </tr> <tr> <td>Dissipation Factor 損耗角正切</td> <td>130% or less of initial specified value 不大於規範值的 130%</td> </tr> <tr> <td>ESR 阻抗值 (*2)</td> <td>130% or less of initial specified value 不大於規範值的 130%</td> </tr> <tr> <td>Leakage Current 漏電流</td> <td>Initial specified value or less 不大於規範值</td> </tr> </table>	Capacitance Change 靜電容量變化率	Within ±10% of initial value 初始值的±10%以內 (*3)	Dissipation Factor 損耗角正切	130% or less of initial specified value 不大於規範值的 130%	ESR 阻抗值 (*2)	130% or less of initial specified value 不大於規範值的 130%	Leakage Current 漏電流	Initial specified value or less 不大於規範值
Capacitance Change 靜電容量變化率	Within ±10% of initial value 初始值的±10%以內 (*3)								
Dissipation Factor 損耗角正切	130% or less of initial specified value 不大於規範值的 130%								
ESR 阻抗值 (*2)	130% or less of initial specified value 不大於規範值的 130%								
Leakage Current 漏電流	Initial specified value or less 不大於規範值								
Marking 標識	Red print on the case top. 鋁殼頂部紅色字體印刷。								

- (*1) If any doubt arises, measure the leakage current after the voltage treatment of applying DC rated voltage continuously to the capacitor for 120 minutes at 105°C.
如未能確定，在 105°C 環境下連續施加額定工作電壓 120 分鐘後測量漏電流。
- (*2) Should be measured at both of the terminal ends closest where the terminals protrude through the plastic platform.
測試應為靠近突出底座兩個端子的末端。
測試應為靠近突出底座的兩個端子的末端。
- (*3) The value before test of examination of resistance to soldering.
焊接測試前的值。

□ DRAWING 外形圖 (Unit: mm)

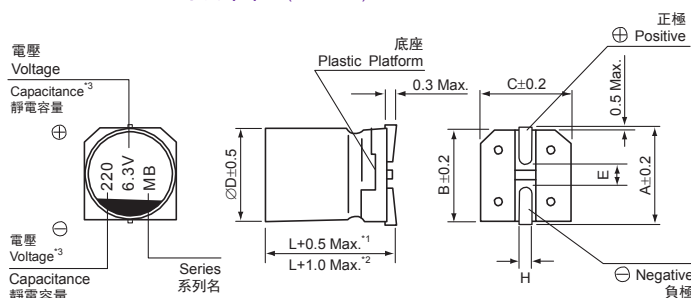

- *1. Applicable to Ø5~Ø8 適用於Ø5~Ø8
 *2. Applicable to Ø10 and above 適用於Ø10 以上
 *3. Capacitance ≥1000µF 容量≥1000µF

Dimension table in next page.
尺寸表見下一頁。

Note: All design and specifications are for reference only and is subject to change without prior notice. If any doubt about safety for your application, please contact us immediately for technical assistance before purchase.

注: 以上所提供的設計及特性參數僅供參考，任何修改不作預先通知。如果在使用上有疑問，請在採購前與我們聯繫，以便提供技術上的協助。

CAT.2023/V2

MB Series

□ DIMENSIONS 尺寸表 (Unit: mm)

∅D × L	5 × 5.5/5.7/5.8	5 × 8/9	6.3 × 4.2/5/5.8	6.3/6 × 6/6.5/6.7	6.3/6 × 7/7.7/8/9	8 × 6.7/7/7.7/9	10 × 10	10 × 12/12.5/13/13.5
A	6.0	6.0	7.3	7.3	7.3	9.0	11.0	11.0
B	5.3	5.3	6.6	6.6	6.6	8.3	10.3	10.3
C	5.3	5.3	6.6	6.6	6.6	8.3	10.3	10.3
E	1.6	1.6	2.1	2.1	2.1	3.2	4.6	4.6
L	5.5/5.7/5.8	8.0/9.0	4.2/5.0/5.8	6.0/6.5/6.7	7.0/7.7/8.0/9.0	6.7/7.0/7.7/9.0	10.0	12.0/12.5/13.0/13.5
H	0.5~0.8	0.5~0.8	0.5~0.8	0.5~0.8	0.5~0.8	0.8~1.1	0.8~1.1	0.8~1.1

□ DIMENSIONS & STANDARD RATINGS 規格尺寸及標準參數

WV (V)		2.5 (0E)					4 (0G)				
Cap. 容量 (μF)	Parameter 參數	Case size ∅D×L (mm) 尺寸	Dissipation factor (tan δ) 損耗角正切	Leakage current (μA) 漏電流	ESR (mΩ) max. 20°C, 100KHz 阻抗值	Ripple current (mA rms) 105°C, 100KHz 紋波電流	Case size ∅D×L (mm) 尺寸	Dissipation factor (tan δ) 損耗角正切	Leakage current (μA) 漏電流	ESR (mΩ) max. 20°C, 100KHz 阻抗值	Ripple current (mA rms) 105°C, 100KHz 紋波電流
220	221						5 × 5.8 (6.3 × 5.8)	0.12 (0.12)	176 (176)	12 (10)	3500 (3900)
270	271						6.3 × 7.7	0.12	216	9	4200
330	331	5 × 5.8	0.12	165	10	3900	6.3 × 5.8 (6.3 × 7) (6.3 × 7.7)	0.12 (0.12) (0.12)	264 (264) (264)	10 (10) (9)	3900 (4500) (4200)
390	391	5 × 5.8 (6.3 × 5.8)	0.12 (0.12)	195 (195)	10 (10)	3900 (3900)	6.3 × 7	0.12	312	10	4500
470	471	6.3 × 7.7	0.12	235	9	4200	6 × 6.7 (8 × 7.7)	0.12 (0.12)	376 (376)	10 (9)	4500 (4500)
560	561	6.3 × 6 (6.3 × 5.8) (6.3 × 7.7)	1.12 (0.12) (0.12)	280 (280) (280)	10 (9) (10)	3900 (4200) (4500)	6 × 6.7 (8 × 7.7)	0.12 (0.12)	448 (448)	10 (9)	4500 (4500)
680	681	6.3 × 7	0.12	340	10	4500	8 × 7.7	0.12	544	9	4500
1000	102	8 × 7.7	0.12	500	9	4500					
2200	222						10 × 12.5	0.12	1760	13	4600

WV (V)		6.3 (0J)					10 (1A)				
Cap. 容量 (μF)	Parameter 參數	Case size ∅D×L (mm) 尺寸	Dissipation factor (tan δ) 損耗角正切	Leakage current (μA) 漏電流	ESR (mΩ) max. 20°C, 100KHz 阻抗值	Ripple current (mA rms) 105°C, 100KHz 紋波電流	Case size ∅D×L (mm) 尺寸	Dissipation factor (tan δ) 損耗角正切	Leakage current (μA) 漏電流	ESR (mΩ) max. 20°C, 100KHz 阻抗值	Ripple current (mA rms) 105°C, 100KHz 紋波電流
68	680						5 × 5.7	0.12	136	27	2000
100	101	5 × 5.5	0.12	126	25	2200	6.3 × 5.5	0.12	200	25	2600
120	121						6.3 × 5.8 (5 × 5.8)	0.12 (0.12)	240 (240)	25 (22)	2600 (2600)
150	151						6.3 × 6.5	0.12	300	20	2800
220	221	6.3 × 4.2 (6.3 × 5) (6.3 × 5.7) (6.3 × 6)	0.12 (0.12) (0.12) (0.12)	277 (277) (277) (277)	18 (16) (18) (16)	3200 (3400) (3400) (3400)	6.3 × 6 (6.3 × 6.5) (6.3 × 7.7)	0.12 (0.12) (0.12)	440 (440) (440)	20 (20) (20)	2900 (2900) (2800)
270	271	5 × 8 (5 × 9)	0.12 (0.12)	340 (340)	16 (16)	3000 (3000)	6.3 × 5.8	0.12	540	20	2800
330	331	6.3 × 6.5	0.12	416	12	3950	8 × 7.7	0.12	660	17	3390
390	391	8 × 6.7	0.12	491	14	3950					
470	471	6.3 × 7.7 (6.3 × 9) (8 × 7)	0.12 (0.12) (0.12)	592 (592) (592)	12 (12) (9)	3950 (3450) (4500)	8 × 9	0.12	940	18	3200
560	561	6.3 × 6 (6.3 × 9)	0.12 (0.12)	706 (706)	10 (10)	4500 (4500)					
1000	102	8 × 12	0.12	1260	10	5100					
1500	152	10 × 10	0.12	1890	9	5600					
2200	222	10 × 13	0.12	2772	10	6100					

Note: All design and specifications are for reference only and is subject to change without prior notice. If any doubt about safety for your application, please contact us immediately for technical assistance before purchase.

注：以上所提供的設計及特性參數僅供參考，任何修改不作預先通知。如果在使用上有疑問，請在採購前與我們聯繫，以便提供技術上的協助。

CAT.2023/V2

MB Series

□ DIMENSIONS & STANDARD RATINGS 規格尺寸及標準參數

WV (V)		16 (1C)					18 (1Z)				
Cap. 容量 (μF)	Parameter 參數	Case size ØD×L (mm) 尺寸	Dissipation factor (tan δ) 損耗角正切	Leakage current (μA) 漏電流	ESR (mΩ) max. 20°C, 100KHz 阻抗值	Ripple current (mA rms) 105°C, 100KHz 紋波電流	Case size ØD×L (mm) 尺寸	Dissipation factor (tan δ) 損耗角正切	Leakage current (μA) 漏電流	ESR (mΩ) max. 20°C, 100KHz 阻抗值	Ripple current (mA rms) 105°C, 100KHz 紋波電流
100	101	6.3 × 6 (6.3 × 6.5) (6.3 × 8)	0.12 (0.12) (0.12)	320 (320) (320)	24 (24) (22)	2500 (2500) (2500)					
180	181	6.3 × 5.8	0.12	576	22	3300					
220	221	6.3 × 7.7 (6.3 × 9) (8 × 9)	0.12 (0.12) (0.12)	704 (704) (704)	22 (20) (16)	3300 (3500) (3800)					
270	271	8 × 6.7 (8 × 9)	0.12 (0.12)	864 (864)	22 (20)	3300 (3800)					
330	331	8 × 7.7	0.12	1056	21	3400					
470	471	10 × 12	0.12	1504	11	5200					
1000	102	10 × 12	0.12	3200	10	5800	10 × 12.5	0.08	3600	9	5500
1500	152						10 × 13.5	0.08	5400	9	5800
2200	222						12 × 13.5	0.08	7920	9	8200

- Taping specifications are given in page 17. 編帶標準請查閱第 17 頁。
- Soldering conditions and recommended land size are given in page 22. 焊接條件及推薦安裝尺寸請查閱第 22 頁。
- Please refer to page 18 for the minimum package quantity. 最小包裝數量請查閱第 18 頁。
- Please refer to page 14 for the Part Number System. 產品編碼規則請查閱第 14 頁。

Note: All design and specifications are for reference only and is subject to change without prior notice. If any doubt about safety for your application, please contact us immediately for technical assistance before purchase.

注：以上所提供的設計及特性參數僅供參考，任何修改不作預先通知。如果在使用上有疑問，請在採購前與我們聯繫，以便提供技術上的協助。

CAT.2023/V2

MR Series

CHIP TYPE, HIGH RELIABILITY

貼片式, 高可靠品



- Operating with wide temperature range -55~+125°C
適用於 -55~+125°C 的寬溫範圍
- High reliability, low ESR, high ripple current
高可靠, 低阻抗, 高紋波電流
- Endurance 1500~3000 hours
耐久性 1500~3000 小時
- RoHS & REACH compliant, Halogen-free
符合 RoHS 與 REACH, 無鹵

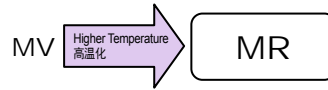

□ SPECIFICATIONS 特性表

Items 項目	Characteristics 主要特性								
Category Temperature Range 工作溫度範圍	-55 ~ +125°C								
Voltage Range 額定工作電壓範圍	16 ~ 50V								
Capacitance Range 靜電容量範圍	5.6 ~ 390µF								
Capacitance Tolerance 靜電容量允許偏差	±20% at 120Hz, 20°C								
Leakage Current 漏電流 (*1)	≤Specified value (after 2 minutes application of rated voltage at 20°C). ≤規範值 (在 20°C 環境中施加額定工作電壓 2 分鐘後)。								
Dissipation Factor (tan δ) 損耗角正切	≤Specified value at 120Hz, 20°C. ≤規範值 (在 20°C 120Hz 環境下)。								
ESR 阻抗值 (*2)	≤Specified value at 100KHz, 20°C. ≤規範值 (在 20°C 100KHz 環境下)。								
Stability at Low Temperature 低溫特性	Measurement frequency 測試頻率: 100KHz <table border="1"> <tr> <td>Impedance Ratio 阻抗比 Z1/Z20 (max.)</td> <td>Z(+125°C)/Z(20°C)</td> <td>≤1.25</td> </tr> <tr> <td></td> <td>Z(-55°C)/Z(20°C)</td> <td>≤1.25</td> </tr> </table>	Impedance Ratio 阻抗比 Z1/Z20 (max.)	Z(+125°C)/Z(20°C)	≤1.25		Z(-55°C)/Z(20°C)	≤1.25		
Impedance Ratio 阻抗比 Z1/Z20 (max.)	Z(+125°C)/Z(20°C)	≤1.25							
	Z(-55°C)/Z(20°C)	≤1.25							
Damp Heat (Steady State) 穩態濕熱	When the capacitors are restored to 20°C after the rated voltage is applied for 1000 hours at 60°C, 90% RH, they meet the characteristics listed below. 在 60°C 和相對濕度 90% 環境下施加額定工作電壓 1000 小時並冷卻至 20°C 後, 電容器的特性符合下表的要求。 <table border="1"> <tr> <td>Capacitance Change 靜電容量變化率</td> <td>Within ±20% of initial value 為初始值的±20%以內 (*3)</td> </tr> <tr> <td>Dissipation Factor 損耗角正切</td> <td>150% or less of initial specified value 不大於規範值的 150%</td> </tr> <tr> <td>ESR 阻抗值 (*2)</td> <td>150% or less of initial specified value 不大於規範值的 150%</td> </tr> <tr> <td>Leakage Current 漏電流</td> <td>Initial specified value or less 不大於規範值</td> </tr> </table>	Capacitance Change 靜電容量變化率	Within ±20% of initial value 為初始值的±20%以內 (*3)	Dissipation Factor 損耗角正切	150% or less of initial specified value 不大於規範值的 150%	ESR 阻抗值 (*2)	150% or less of initial specified value 不大於規範值的 150%	Leakage Current 漏電流	Initial specified value or less 不大於規範值
Capacitance Change 靜電容量變化率	Within ±20% of initial value 為初始值的±20%以內 (*3)								
Dissipation Factor 損耗角正切	150% or less of initial specified value 不大於規範值的 150%								
ESR 阻抗值 (*2)	150% or less of initial specified value 不大於規範值的 150%								
Leakage Current 漏電流	Initial specified value or less 不大於規範值								
Endurance 耐久性	After 3000 hours (1500 hours for Ø6.3) application of the rated voltage at 125°C, they meet the characteristics listed below. 在 125°C 環境中施加額定工作電壓 3000 小時 (Ø6.3 為 1500 小時) 後, 電容器的特性符合下表的要求。 <table border="1"> <tr> <td>Capacitance Change 靜電容量變化率</td> <td>Within ±20% of initial value 為初始值的±20%以內 (*3)</td> </tr> <tr> <td>Dissipation Factor 損耗角正切</td> <td>150% or less of initial specified value 不大於規範值的 150%</td> </tr> <tr> <td>ESR 阻抗值 (*2)</td> <td>150% or less of initial specified value 不大於規範值的 150%</td> </tr> <tr> <td>Leakage Current 漏電流</td> <td>Initial specified value or less 不大於規範值</td> </tr> </table>	Capacitance Change 靜電容量變化率	Within ±20% of initial value 為初始值的±20%以內 (*3)	Dissipation Factor 損耗角正切	150% or less of initial specified value 不大於規範值的 150%	ESR 阻抗值 (*2)	150% or less of initial specified value 不大於規範值的 150%	Leakage Current 漏電流	Initial specified value or less 不大於規範值
Capacitance Change 靜電容量變化率	Within ±20% of initial value 為初始值的±20%以內 (*3)								
Dissipation Factor 損耗角正切	150% or less of initial specified value 不大於規範值的 150%								
ESR 阻抗值 (*2)	150% or less of initial specified value 不大於規範值的 150%								
Leakage Current 漏電流	Initial specified value or less 不大於規範值								
Resistance to Soldering Heat 耐焊接熱特性 (Please refer page 22 for soldering conditions) (焊接條件請查閱第 22 頁)	After reflow soldering and restored at room temperature, they meet the characteristics listed below. 經過回流焊並冷卻至室溫後, 電容器的特性符合下表的要求。 <table border="1"> <tr> <td>Capacitance Change 靜電容量變化率</td> <td>Within ±10% of initial value 初始值的±10%以內 (*3)</td> </tr> <tr> <td>Dissipation Factor 損耗角正切</td> <td>130% or less of initial specified value 不大於規範值的 130%</td> </tr> <tr> <td>ESR 阻抗值 (*2)</td> <td>130% or less of initial specified value 不大於規範值的 130%</td> </tr> <tr> <td>Leakage Current 漏電流</td> <td>Initial specified value or less 不大於規範值</td> </tr> </table>	Capacitance Change 靜電容量變化率	Within ±10% of initial value 初始值的±10%以內 (*3)	Dissipation Factor 損耗角正切	130% or less of initial specified value 不大於規範值的 130%	ESR 阻抗值 (*2)	130% or less of initial specified value 不大於規範值的 130%	Leakage Current 漏電流	Initial specified value or less 不大於規範值
Capacitance Change 靜電容量變化率	Within ±10% of initial value 初始值的±10%以內 (*3)								
Dissipation Factor 損耗角正切	130% or less of initial specified value 不大於規範值的 130%								
ESR 阻抗值 (*2)	130% or less of initial specified value 不大於規範值的 130%								
Leakage Current 漏電流	Initial specified value or less 不大於規範值								
Marking 標識	Red print on the case top. 鋁殼頂部紅色字體印刷。								

(*1) If any doubt arises, measure the leakage current after the voltage treatment of applying DC rated voltage continuously to the capacitor for 120 minutes at 105°C.
如未能確定, 在 105°C 環境下連續施加額定工作電壓 120 分鐘後測量漏電流。

(*2) Should be measured at both of the terminal ends closest where the terminals protrude through the plastic platform.
測試應為靠近突出底座兩個端子的末端。

(*3) The value before test of examination of resistance to soldering.
焊接測試前的值。

□ DRAWING 外形圖 (Unit: mm)

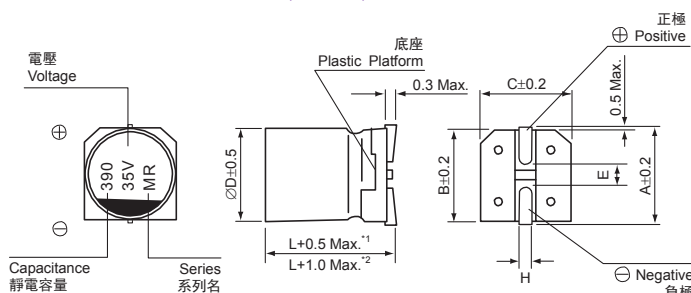

*1. Applicable to Ø6.3 and Ø8 適用於Ø6.3和Ø8
*2. Applicable to Ø10 and above 適用於Ø10和Ø10以上

Dimension table in next page.
尺寸表見下一頁。

Note: All design and specifications are for reference only and is subject to change without prior notice. If any doubt about safety for your application, please contact us immediately for technical assistance before purchase.

注: 以上所提供的設計及特性參數僅供參考, 任何修改不作預先通知。如果在使用上有疑問, 請在採購前與我們聯繫, 以便提供技術上的協助。

MR Series

□ DIMENSIONS 尺寸表 (Unit: mm)

∅D × L	6.3 × 6/8	8 × 7/7.5	8 × 10/10.5	8 × 12	10 × 8	10 × 10/10.5	10 × 12.7
A	7.3	9.0	9.0	9.0	11.0	11.0	11.0
B	6.6	8.3	8.3	8.3	10.3	10.3	10.3
C	6.6	8.3	8.3	8.3	10.3	10.3	10.3
E	2.1	3.2	3.2	3.2	4.6	4.6	4.6
L	6.0/8.0	7.0/7.5	10.0/10.5	12	8.0	10.0/10.5	12.7
H	0.5~0.8	0.8~1.1	0.8~1.1	0.8~1.1	0.8~1.1	0.8~1.1	0.8~1.1

□ DIMENSIONS & STANDARD RATINGS 規格尺寸及標準參數

Cap. 容量 (μF)	Parameter 參數	WV (V)	16 (1C)					20 (1D)						
			Case size ∅D×L (mm) 尺寸	Dissipation factor (tan δ) 損耗角正切	Leakage current (μA) 漏電流	ESR (mΩ) max. 20°C, 100KHz 阻抗值	Ripple current (mA rms) 紋波電流		Case size ∅D×L (mm) 尺寸	Dissipation factor (tan δ) 損耗角正切	Leakage current (μA) 漏電流	ESR (mΩ) max. 20°C, 100KHz 阻抗值	Ripple current (mA rms) 紋波電流	
							≤105°C ⁽³⁾	105°C≤125°C ⁽³⁾					≤105°C ⁽³⁾	105°C≤125°C ⁽³⁾
33	330							6.3 × 6	0.12	132	60	900	380	
47	470		6.3 × 6	0.12	150	55	1000	390						
56	560							8 × 7 (8 × 7.5)	0.12 (0.12)	224 (224)	50 (50)	1300 (1300)	500 (500)	
68	680							6.3 × 8	0.12	272	34	1450	470	
82	820		8 × 7 (8 × 7.5)	0.12 (0.12)	262 (262)	45 (45)	1300 (1300)	530 (530)						
100	101		6.3 × 8	0.12	320	33	1500	460						
120	121							8 × 10 (8 × 10.5) (10 × 8)	0.12 (0.12) (0.12)	480 (480) (480)	29 (29) (35)	1900 (1900) (1800)	770 (770) (810)	
150	151		8 × 10 (10 × 8)	0.12 (0.12)	480 (480)	28 (33)	2000 (1900)	780 (830)	8 × 12	0.12	600	28	2200	860
180	181							10 × 10 (10 × 10.5)	0.12 (0.12)	720 (720)	28 (28)	2300 (2300)	800 (800)	
220	221		8 × 12	0.12	704	27	2300	870						
270	271		10 × 10 (10 × 10.5)	0.12 (0.12)	864 (864)	27 (27)	2300 (2300)	830 (830)	10 × 12.7	0.12	1080	27	2700	1020
390	391		10 × 12.7	0.12	1248	26	2700	1040						

Cap. 容量 (μF)	Parameter 參數	WV (V)	25 (1E)					35 (1V)						
			Case size ∅D×L (mm) 尺寸	Dissipation factor (tan δ) 損耗角正切	Leakage current (μA) 漏電流	ESR (mΩ) max. 20°C, 100KHz 阻抗值	Ripple current (mA rms) 紋波電流		Case size ∅D×L (mm) 尺寸	Dissipation factor (tan δ) 損耗角正切	Leakage current (μA) 漏電流	ESR (mΩ) max. 20°C, 100KHz 阻抗值	Ripple current (mA rms) 紋波電流	
							≤105°C ⁽³⁾	105°C≤125°C ⁽³⁾					≤105°C ⁽³⁾	105°C≤125°C ⁽³⁾
10	100							6.3 × 6	0.12	70	85	800	310	
18	180							8 × 7 (8 × 7.5)	0.12 (0.12)	126 (126)	60 (60)	1100 (1100)	450 (450)	
22	220		6.3 × 6	0.12	110	65	900	360						
27	270							6.3 × 8	0.12	189	45	1300	450	
39	390		8 × 7 (8 × 7.5)	0.12 (0.12)	195 (195)	55 (55)	1200 (1200)	480 (480)	8 × 10 (8 × 10.5) (10 × 8)	0.12 (0.12) (0.12)	273 (273) (273)	35 (35) (41)	1800 (1800) (1700)	700 (700) (750)
56	560		6.3 × 8	0.12	280	35	1400	450	8 × 12	0.12	392	33	2000	780
68	680							10 × 10 (10 × 10.5)	0.12 (0.12)	476 (476)	30 (30)	2200 (2200)	740 (740)	
82	820		8 × 10 (8 × 10.5) (10 × 8)	0.12 (0.12) (0.12)	410 (410) (410)	30 (30) (36)	1900 (1900) (1800)	760 (760) (800)						
100	101		6.3 × 7.7	0.12	500	32	1800	800	8 × 9 (10 × 10) (10 × 12.7)	0.12 (0.12) (0.12)	700 (700) (700)	30 (25) (29)	2200 (2400) (2600)	740 (800) (990)
120	121		8 × 12 (10 × 10.5)	0.12 (0.12)	600 (600)	29 (29)	2200 (2200)	850 (850)						
180	181		10 × 12.7	0.12	900	28	2600	1010						

Note: All design and specifications are for reference only and is subject to change without prior notice. If any doubt about safety for your application, please contact us immediately for technical assistance before purchase.

注：以上所提供的設計及特性參數僅供參考，任何修改不作預先通知。如果在使用上有疑問，請在採購前與我們聯繫，以便提供技術上的協助。

CAT.2023/V2

MR Series

□ DIMENSIONS & STANDARD RATINGS 規格尺寸及標準參數

WV (V)		50 (1H)					
Cap. 容量 (μF)	Parameter 參數	Case size ØD×L (mm) 尺寸	Dissipation factor (tan δ) 損耗角正切	Leakage current (μA) 漏電流	ESR (mΩ) max. 20°C, 100KHz 阻抗值	Ripple current (mA rms) 紋波電流	
						≤105°C (3)	105°C≤125°C (3)
						5.6	5R6
10	100	8 × 7 (8 × 7.5)	0.12 (0.12)	100 (100)	75 (75)	1000 (1000)	410 (410)
12	120	6.3 × 8	0.12	120	65	1100	380
22	220	8 × 10 (8 × 10.5) (10 × 8)	0.12 (0.12) (0.12)	220 (220) (220)	37 (37) (56)	1700 (1700) (1400)	680 (680) (730)
27	270	8 × 12	0.12	270	35	2000	760
33	330	10 × 10 (10 × 10.5)	0.12 (0.12)	330 (330)	31 (31)	2200 (2200)	630 (630)
47	470	10 × 12.7	0.12	470	30	2500	970

- Taping specifications are given in page 17. 編帶標準請查閱第 17 頁。
- Soldering conditions and recommended land size are given in page 22. 焊接條件及推薦安裝尺寸請查閱第 22 頁。
- Please refer to page 18 for the minimum package quantity. 最小包裝數量請查閱第 18 頁。
- Please refer to page 14 for the Part Number System. 產品編碼規則請查閱第 14 頁。

Note: All design and specifications are for reference only and is subject to change without prior notice. If any doubt about safety for your application, please contact us immediately for technical assistance before purchase.

注：以上所提供的設計及特性參數僅供參考，任何修改不作預先通知。如果在使用上有疑問，請在採購前與我們聯繫，以便提供技術上的協助。

CAT.2023/V2

MS Series

CHIP TYPE, LONG LIFE

貼片式，長壽命品



- Operating with wide temperature range -55~+105°C
適用於 -55~+105°C 的寬溫範圍
- Long life assurance
長壽命
- Endurance 5000 hours
耐久性 5000 小時
- RoHS & REACH compliant, Halogen-free
符合 RoHS 與 REACH，無鹵

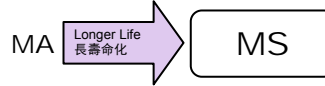

□ SPECIFICATIONS 特性表

Items 項目	Characteristics 主要特性								
Category Temperature Range 工作溫度範圍	-55 ~ +105°C								
Voltage Range 額定工作電壓範圍	4 ~ 50V								
Capacitance Range 靜電容量範圍	22 ~ 560µF								
Capacitance Tolerance 靜電容量允許偏差	±20% at 120Hz, 20°C								
Leakage Current 漏電流 (*1)	≤Specified value (after 2 minutes application of rated voltage at 20°C). ≤規範值 (在 20°C 環境中施加額定工作電壓 2 分鐘後)。								
Dissipation Factor (tan δ) 損耗角正切	≤Specified value at 120Hz, 20°C. ≤規範值 (在 20°C 120Hz 環境下)。								
ESR 阻抗值 (*2)	≤Specified value at 100KHz, 20°C. ≤規範值 (在 20°C 100KHz 環境下)。								
Stability at Low Temperature 低溫特性	Measurement frequency 測試頻率: 100KHz <table border="1"> <tr> <td>Impedance Ratio 阻抗比 ZT/Z20 (max.)</td> <td>Z(+105°C)/Z(20°C) Z(-55°C)/Z(20°C)</td> <td>≤1.25 ≤1.25</td> </tr> </table>	Impedance Ratio 阻抗比 ZT/Z20 (max.)	Z(+105°C)/Z(20°C) Z(-55°C)/Z(20°C)	≤1.25 ≤1.25					
Impedance Ratio 阻抗比 ZT/Z20 (max.)	Z(+105°C)/Z(20°C) Z(-55°C)/Z(20°C)	≤1.25 ≤1.25							
Damp Heat (Steady State) 穩態濕熱	When the capacitors are restored to 20°C after the rated voltage is applied for 1000 hours at 60°C, 90% RH, they meet the characteristics listed below. 在 60°C 和相對濕度 90% 環境下施加額定工作電壓 1000 小時並冷卻至 20°C 後，電容器的特性符合下表的要求。 <table border="1"> <tr> <td>Capacitance Change 靜電容量變化率</td> <td>Within ±20% of initial value 為初始值的±20%以內 (*3)</td> </tr> <tr> <td>Dissipation Factor 損耗角正切</td> <td>150% or less of initial specified value 不大於規範值的 150%</td> </tr> <tr> <td>ESR 阻抗值 (*2)</td> <td>150% or less of initial specified value 不大於規範值的 150%</td> </tr> <tr> <td>Leakage Current 漏電流</td> <td>Initial specified value or less 不大於規範值</td> </tr> </table>	Capacitance Change 靜電容量變化率	Within ±20% of initial value 為初始值的±20%以內 (*3)	Dissipation Factor 損耗角正切	150% or less of initial specified value 不大於規範值的 150%	ESR 阻抗值 (*2)	150% or less of initial specified value 不大於規範值的 150%	Leakage Current 漏電流	Initial specified value or less 不大於規範值
Capacitance Change 靜電容量變化率	Within ±20% of initial value 為初始值的±20%以內 (*3)								
Dissipation Factor 損耗角正切	150% or less of initial specified value 不大於規範值的 150%								
ESR 阻抗值 (*2)	150% or less of initial specified value 不大於規範值的 150%								
Leakage Current 漏電流	Initial specified value or less 不大於規範值								
Endurance 耐久性	After 5000 hours application of the rated voltage at 105°C, they meet the characteristics listed below. 在 105°C 環境中施加額定工作電壓 5000 小時後，電容器的特性符合下表的要求。 <table border="1"> <tr> <td>Capacitance Change 靜電容量變化率</td> <td>Within ±20% of initial value 為初始值的±20%以內 (*3)</td> </tr> <tr> <td>Dissipation Factor 損耗角正切</td> <td>150% or less of initial specified value 不大於規範值的 150%</td> </tr> <tr> <td>ESR 阻抗值 (*2)</td> <td>150% or less of initial specified value 不大於規範值的 150%</td> </tr> <tr> <td>Leakage Current 漏電流</td> <td>Initial specified value or less 不大於規範值</td> </tr> </table>	Capacitance Change 靜電容量變化率	Within ±20% of initial value 為初始值的±20%以內 (*3)	Dissipation Factor 損耗角正切	150% or less of initial specified value 不大於規範值的 150%	ESR 阻抗值 (*2)	150% or less of initial specified value 不大於規範值的 150%	Leakage Current 漏電流	Initial specified value or less 不大於規範值
Capacitance Change 靜電容量變化率	Within ±20% of initial value 為初始值的±20%以內 (*3)								
Dissipation Factor 損耗角正切	150% or less of initial specified value 不大於規範值的 150%								
ESR 阻抗值 (*2)	150% or less of initial specified value 不大於規範值的 150%								
Leakage Current 漏電流	Initial specified value or less 不大於規範值								
Resistance to Soldering Heat 耐焊接熱特性 <small>(Please refer page 22 for soldering conditions) (焊接條件請查閱第 22 頁)</small>	After reflow soldering and restored at room temperature, they meet the characteristics listed below. 經過回流焊並冷卻至室溫後，電容器的特性符合下表的要求。 <table border="1"> <tr> <td>Capacitance Change 靜電容量變化率</td> <td>Within ±10% of initial value 初始值的±10%以內 (*3)</td> </tr> <tr> <td>Dissipation Factor 損耗角正切</td> <td>130% or less of initial specified value 不大於規範值的 130%</td> </tr> <tr> <td>ESR 阻抗值 (*2)</td> <td>130% or less of initial specified value 不大於規範值的 130%</td> </tr> <tr> <td>Leakage Current 漏電流</td> <td>Initial specified value or less 不大於規範值</td> </tr> </table>	Capacitance Change 靜電容量變化率	Within ±10% of initial value 初始值的±10%以內 (*3)	Dissipation Factor 損耗角正切	130% or less of initial specified value 不大於規範值的 130%	ESR 阻抗值 (*2)	130% or less of initial specified value 不大於規範值的 130%	Leakage Current 漏電流	Initial specified value or less 不大於規範值
Capacitance Change 靜電容量變化率	Within ±10% of initial value 初始值的±10%以內 (*3)								
Dissipation Factor 損耗角正切	130% or less of initial specified value 不大於規範值的 130%								
ESR 阻抗值 (*2)	130% or less of initial specified value 不大於規範值的 130%								
Leakage Current 漏電流	Initial specified value or less 不大於規範值								
Marking 標識	Red print on the case top. 鋁殼頂部紅色字體印刷。								

(*1) If any doubt arises, measure the leakage current after the voltage treatment of applying DC rated voltage continuously to the capacitor for 120 minutes at 105°C.

如未能確定，在 105°C 環境下連續施加額定工作電壓 120 分鐘後測量漏電流。

(*2) Should be measured at both of the terminal ends closest where the terminals protrude through the plastic platform.

測試應為靠近突出底座兩個端子的末端。

(*3) The value before test of examination of resistance to soldering.

焊接測試前的值。

□ DRAWING 外形圖 (Unit: mm)

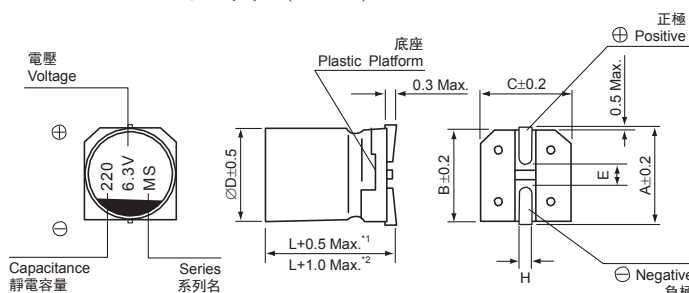

*1. Applicable to Ø5~Ø8 適用於Ø5~Ø8
*2. Applicable to Ø10 and above 適用於Ø10和Ø10以上

Dimension table in next page.
尺寸表見下一頁。

Note: All design and specifications are for reference only and is subject to change without prior notice. If any doubt about safety for your application, please contact us immediately for technical assistance before purchase.

注：以上所提供的設計及特性參數僅供參考，任何修改不作預先通知。如果在使用上有疑問，請在採購前與我們聯繫，以便提供技術上的協助。

CAT.2023/V2

MS Series

□ DIMENSIONS 尺寸表 (Unit: mm)

∅D × L	5 × 6	6.3 × 6/6.5	8 × 7	6.3 × 7/7.7	6.3 × 9.5	8 × 12	10 × 12
A	6.0	7.3	9.0	7.3	7.3	8.0	10.0
B	5.3	6.6	8.3	6.6	6.6	8.3	10.3
C	5.3	6.6	8.3	6.6	6.6	8.3	10.3
E	1.6	2.1	3.2	2.1	2.1	3.2	4.6
L	6.0	6.0/6.5	7.0	7.0/7.7	9.5	12.0	12.0
H	0.5~0.8	0.5~0.8	0.8~1.1	0.5~0.8	0.5~0.8	0.8~1.1	0.8~1.1

□ DIMENSIONS & STANDARD RATINGS 規格尺寸及標準參數

WV (V)		4 (0G)					6.3 (0J)				
Cap. 容量 (μF)	Parameter 參數	Case size ∅D×L (mm) 尺寸	Dissipation factor (tan δ) 損耗角正切	Leakage current (μA) 漏電流	ESR (mΩ) max. 20°C, 100KHz 阻抗值	Ripple current (mA rms) 105°C, 100KHz 紋波電流	Case size ∅D×L (mm) 尺寸	Dissipation factor (tan δ) 損耗角正切	Leakage current (μA) 漏電流	ESR (mΩ) max. 20°C, 100KHz 阻抗值	Ripple current (mA rms) 105°C, 100KHz 紋波電流
100	101						5 × 6 (6.3 × 6)	0.12 (0.12)	126 (126)	25 (22)	2400 (2800)
120	121						6.3 × 6	0.12	151	22	2800
150	151	5 × 6	0.12	120	25	2200					
220	221						6.3 × 6 (8 × 7)	0.12 (0.12)	277 (277)	20 (22)	2800 (3200)
330	331	6.3 × 6 (8 × 7)	0.12 (0.12)	264 (264)	20 (22)	2800 (3200)	6.3 × 6.5	0.12	416	20	3000
390	391						8 × 7	0.12	491	22	3200
470	471						6.3 × 9.5	0.12	592	18	3200
560	561	8 × 7	0.12	448	18	3600					

WV (V)		10 (1A)					16 (1C)				
Cap. 容量 (μF)	Parameter 參數	Case size ∅D×L (mm) 尺寸	Dissipation factor (tan δ) 損耗角正切	Leakage current (μA) 漏電流	ESR (mΩ) max. 20°C, 100KHz 阻抗值	Ripple current (mA rms) 105°C, 100KHz 紋波電流	Case size ∅D×L (mm) 尺寸	Dissipation factor (tan δ) 損耗角正切	Leakage current (μA) 漏電流	ESR (mΩ) max. 20°C, 100KHz 阻抗值	Ripple current (mA rms) 105°C, 100KHz 紋波電流
33	330	5 × 6	0.12	66	40	1300					
39	390						5 × 6 (6.3 × 6)	0.12 (0.12)	125 (125)	35 (30)	2000 (2200)
56	560	6.3 × 6	0.12	112	27	2300					
68	680	5 × 6	0.12	136	30	2100	6.3 × 6	0.12	218	30	2200
82	820						8 × 7	0.12	262	28	2800
120	121	6.3 × 6	0.12	240	27	2300	8 × 7	0.12	384	28	2800
150	151	8 × 7	0.12	300	30	2600					
220	221	6.3 × 7	0.12	440	22	2800	6.3 × 7.7	0.12	704	30	2800
270	271	6.3 × 7.7 (8 × 7)	0.12 (0.12)	540 (540)	22 (22)	3000 (3200)					

WV (V)		25 (1E)					35 (1V)				
Cap. 容量 (μF)	Parameter 參數	Case size ∅D×L (mm) 尺寸	Dissipation factor (tan δ) 損耗角正切	Leakage current (μA) 漏電流	ESR (mΩ) max. 20°C, 100KHz 阻抗值	Ripple current (mA rms) 105°C, 100KHz 紋波電流	Case size ∅D×L (mm) 尺寸	Dissipation factor (tan δ) 損耗角正切	Leakage current (μA) 漏電流	ESR (mΩ) max. 20°C, 100KHz 阻抗值	Ripple current (mA rms) 105°C, 100KHz 紋波電流
100	101	6.3 × 7.7 (6.3 × 9.5)	0.12 (0.12)	500 (500)	32 (32)	2600 (2900)					
150	151						8 × 12 (10 × 12)	0.12 (0.12)	1050 (1050)	28 (28)	2500 (2600)
180	181	8 × 12	0.12	900	16	4650					

WV (V)		50 (1H)				
Cap. 容量 (μF)	Parameter 參數	Case size ∅D×L (mm) 尺寸	Dissipation factor (tan δ) 損耗角正切	Leakage current (μA) 漏電流	ESR (mΩ) max. 20°C, 100KHz 阻抗值	Ripple current (mA rms) 105°C, 100KHz 紋波電流
68	680	10 × 12	0.12	680	20	4300

- Taping specifications are given in page 17. 編帶標準請查閱第 17 頁。
- Soldering conditions and recommended land size are given in page 22. 焊接條件及推薦安裝尺寸請查閱第 22 頁。
- Please refer to page 18 for the minimum package quantity. 最小包裝數量請查閱第 18 頁。
- Please refer to page 14 for the Part Number System. 產品編碼規則請查閱第 14 頁。

Note: All design and specifications are for reference only and is subject to change without prior notice. If any doubt about safety for your application, please contact us immediately for technical assistance before purchase.

注：以上所提供的設計及特性參數僅供參考，任何修改不作預先通知。如果在使用上有疑問，請在採購前與我們聯繫，以便提供技術上的協助。

CAT.2023/V2

MX Series

CHIP TYPE, ULTRA LONG LIFE

貼片式, 超長壽命品



- Operating with wide temperature range -55~+105°C
適用於 -55~+105°C 的寬溫範圍
- Ultra-low ESR, High Ripple Current
超低阻抗, 高紋波電流
- Endurance 20000 hours
耐久性 20000 小時
- RoHS & REACH compliant, Halogen-free
符合 RoHS 與 REACH, 無鹵

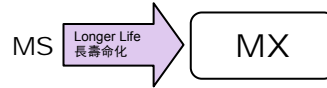

□ SPECIFICATIONS 特性表

Items 項目	Characteristics 主要特性								
Category Temperature Range 工作溫度範圍	-55 ~ +105°C								
Voltage Range 額定工作電壓範圍	4 ~ 16V								
Capacitance Range 靜電容量範圍	22 ~ 560µF								
Capacitance Tolerance 靜電容量允許偏差	±20% at 120Hz, 20°C								
Leakage Current 漏電流 (*1)	≤Specified value (after 2 minutes application of rated voltage at 20°C). ≤規範值 (在 20°C 環境中施加額定工作電壓 2 分鐘後)。								
Dissipation Factor (tan δ) 損耗角正切	≤Specified value at 120Hz, 20°C. ≤規範值 (在 20°C 120Hz 環境下)。								
ESR 阻抗值 (*2)	≤Specified value at 100KHz, 20°C. ≤規範值 (在 20°C 100KHz 環境下)。								
Stability at Low Temperature 低溫特性	Measurement frequency 測試頻率: 100KHz <table border="1"> <tr> <td>Impedance Ratio 阻抗比 ZT/Z20 (max.)</td> <td>Z(+105°C)/Z(20°C) Z(-55°C)/Z(20°C)</td> <td>≤1.25 ≤1.25</td> </tr> </table>	Impedance Ratio 阻抗比 ZT/Z20 (max.)	Z(+105°C)/Z(20°C) Z(-55°C)/Z(20°C)	≤1.25 ≤1.25					
Impedance Ratio 阻抗比 ZT/Z20 (max.)	Z(+105°C)/Z(20°C) Z(-55°C)/Z(20°C)	≤1.25 ≤1.25							
Damp Heat (Steady State) 穩態濕熱	When the capacitors are restored to 20°C after the rated voltage is applied for 1000 hours at 60°C, 90% RH, they meet the characteristics listed below. 在 60°C 和相對濕度 90%環境下施加額定工作電壓 1000 小時並冷卻至 20°C 後, 電容器的特性符合下表的要求。 <table border="1"> <tr> <td>Capacitance Change 靜電容量變化率</td> <td>Within ±20% of initial value 為初始值的±20%以內 (*3)</td> </tr> <tr> <td>Dissipation Factor 損耗角正切</td> <td>150% or less of initial specified value 不大於規範值的 150%</td> </tr> <tr> <td>ESR 阻抗值 (*2)</td> <td>150% or less of initial specified value 不大於規範值的 150%</td> </tr> <tr> <td>Leakage Current 漏電流</td> <td>Initial specified value or less 不大於規範值</td> </tr> </table>	Capacitance Change 靜電容量變化率	Within ±20% of initial value 為初始值的±20%以內 (*3)	Dissipation Factor 損耗角正切	150% or less of initial specified value 不大於規範值的 150%	ESR 阻抗值 (*2)	150% or less of initial specified value 不大於規範值的 150%	Leakage Current 漏電流	Initial specified value or less 不大於規範值
Capacitance Change 靜電容量變化率	Within ±20% of initial value 為初始值的±20%以內 (*3)								
Dissipation Factor 損耗角正切	150% or less of initial specified value 不大於規範值的 150%								
ESR 阻抗值 (*2)	150% or less of initial specified value 不大於規範值的 150%								
Leakage Current 漏電流	Initial specified value or less 不大於規範值								
Endurance 耐久性	After 20000 hours application of the rated voltage at 105°C, they meet the characteristics listed below. 在 105°C 環境中施加額定工作電壓 20000 小時後, 電容器的特性符合下表的要求。 <table border="1"> <tr> <td>Capacitance Change 靜電容量變化率</td> <td>Within ±20% of initial value 為初始值的±20%以內 (*3)</td> </tr> <tr> <td>Dissipation Factor 損耗角正切</td> <td>150% or less of initial specified value 不大於規範值的 150%</td> </tr> <tr> <td>ESR 阻抗值 (*2)</td> <td>150% or less of initial specified value 不大於規範值的 150%</td> </tr> <tr> <td>Leakage Current 漏電流</td> <td>Initial specified value or less 不大於規範值</td> </tr> </table>	Capacitance Change 靜電容量變化率	Within ±20% of initial value 為初始值的±20%以內 (*3)	Dissipation Factor 損耗角正切	150% or less of initial specified value 不大於規範值的 150%	ESR 阻抗值 (*2)	150% or less of initial specified value 不大於規範值的 150%	Leakage Current 漏電流	Initial specified value or less 不大於規範值
Capacitance Change 靜電容量變化率	Within ±20% of initial value 為初始值的±20%以內 (*3)								
Dissipation Factor 損耗角正切	150% or less of initial specified value 不大於規範值的 150%								
ESR 阻抗值 (*2)	150% or less of initial specified value 不大於規範值的 150%								
Leakage Current 漏電流	Initial specified value or less 不大於規範值								
Resistance to Soldering Heat 耐焊接熱特性 (Please refer page 22 for soldering conditions) (焊接條件請查閱第 22 頁)	After reflow soldering and restored at room temperature, they meet the characteristics listed below. 經過回流焊並冷卻至室溫後, 電容器的特性符合下表的要求。 <table border="1"> <tr> <td>Capacitance Change 靜電容量變化率</td> <td>Within ±10% of initial value 初始值的±10%以內 (*3)</td> </tr> <tr> <td>Dissipation Factor 損耗角正切</td> <td>130% or less of initial specified value 不大於規範值的 130%</td> </tr> <tr> <td>ESR 阻抗值 (*2)</td> <td>130% or less of initial specified value 不大於規範值的 130%</td> </tr> <tr> <td>Leakage Current 漏電流</td> <td>Initial specified value or less 不大於規範值</td> </tr> </table>	Capacitance Change 靜電容量變化率	Within ±10% of initial value 初始值的±10%以內 (*3)	Dissipation Factor 損耗角正切	130% or less of initial specified value 不大於規範值的 130%	ESR 阻抗值 (*2)	130% or less of initial specified value 不大於規範值的 130%	Leakage Current 漏電流	Initial specified value or less 不大於規範值
Capacitance Change 靜電容量變化率	Within ±10% of initial value 初始值的±10%以內 (*3)								
Dissipation Factor 損耗角正切	130% or less of initial specified value 不大於規範值的 130%								
ESR 阻抗值 (*2)	130% or less of initial specified value 不大於規範值的 130%								
Leakage Current 漏電流	Initial specified value or less 不大於規範值								
Marking 標識	Red print on the case top. 鋁殼頂部紅色字體印刷。								

(*1) If any doubt arises, measure the leakage current after the voltage treatment of applying DC rated voltage continuously to the capacitor for 120 minutes at 105°C.

如未能確定, 在 105°C 環境下連續施加額定工作電壓 120 分鐘後測量漏電流。

(*2) Should be measured at both of the terminal ends closest where the terminals protrude through the plastic platform.

測試應為靠近突出底座的兩個端子的末端。

(*3) The value before test of examination of resistance to soldering.

焊接測試前的值。

□ DRAWING 外形圖 (Unit: mm)

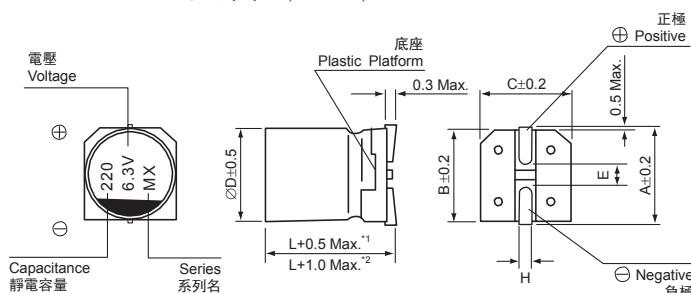

*1. Applicable to Ø5~Ø8

適用於Ø5~Ø8

*2. Applicable to Ø10 and above

適用於Ø10和Ø10以上

Dimension table in next page.
尺寸表見下一頁。

Note: All design and specifications are for reference only and is subject to change without prior notice. If any doubt about safety for your application, please contact us immediately for technical assistance before purchase.

注: 以上所提供的設計及特性參數僅供參考, 任何修改不作預先通知。如果在使用上有疑問, 請在採購前與我們聯繫, 以便提供技術上的協助。

CAT.2023/V2

MX Series

□ DIMENSIONS 尺寸表 (Unit: mm)

∅D × L	5 × 6	6.3 × 6/7.7	8 × 7/8
A	6.0	7.3	9.0
B	5.3	6.6	8.3
C	5.3	6.6	8.3
E	1.6	2.1	3.2
L	6.0	6.0/7.7	7.0/8.0
H	0.5~0.8	0.5~0.8	0.8~1.1

□ DIMENSIONS & STANDARD RATINGS 規格尺寸及標準參數

WV (V)		4 (0G)					6.3 (0J)				
Cap. 容量 (μF)	Parameter 參數	Case size ∅D×L (mm) 尺寸	Dissipation factor (tan δ) 損耗角正切	Leakage current (μA) 漏電流	ESR (mΩ) max. 20°C, 100KHz 阻抗值	Ripple current (mA rms) 105°C, 100KHz 紋波電流	Case size ∅D×L (mm) 尺寸	Dissipation factor (tan δ) 損耗角正切	Leakage current (μA) 漏電流	ESR (mΩ) max. 20°C, 100KHz 阻抗值	Ripple current (mA rms) 105°C, 100KHz 紋波電流
		47	470						5 × 6	0.12	59.22
100	101						5 × 6 (6.3 × 6)	0.12 (0.12)	126 (126)	25 (22)	2400 (2800)
120	121										
150	151	5 × 6	0.12	120	25	2200	6.3 × 6	0.12	189	22	2800
220	221						6.3 × 6 (8 × 7)	0.12 (0.12)	277 (277)	20 (22)	2800 (3200)
330	331	6.3 × 6 (8 × 7)	0.12 (0.12)	264 (264)	20 (22)	2800 (3200)	6.3 × 7.7	0.12	416	22	3200
390	391						8 × 7	0.12	491	22	3200
560	561	8 × 7	0.12	448	18	3600					

WV (V)		10 (1A)					16 (1C)				
Cap. 容量 (μF)	Parameter 參數	Case size ∅D×L (mm) 尺寸	Dissipation factor (tan δ) 損耗角正切	Leakage current (μA) 漏電流	ESR (mΩ) max. 20°C, 100KHz 阻抗值	Ripple current (mA rms) 105°C, 100KHz 紋波電流	Case size ∅D×L (mm) 尺寸	Dissipation factor (tan δ) 損耗角正切	Leakage current (μA) 漏電流	ESR (mΩ) max. 20°C, 100KHz 阻抗值	Ripple current (mA rms) 105°C, 100KHz 紋波電流
		22	220						5 × 6	0.12	70.4
33	330	5 × 6	0.12	66	40	1300					
39	390						5 × 6 (6.3 × 6)	0.12 (0.12)	125 (125)	35 (30)	2000 (2200)
56	560	6.3 × 6	0.12	112	27	2300					
68	680	5 × 6	0.12	136	30	2100	6.3 × 6	0.12	218	30	2200
82	820						8 × 7	0.12	262	28	2800
120	121	6.3 × 6	0.12	240	27	2300	8 × 7	0.12	384	28	2800
150	151	8 × 7	0.12	300	30	2600					
220	221						8 × 8	0.12	704	28	3000
270	271	8 × 7	0.12	540	22	3200					

- Taping specifications are given in page 17. 編帶標準請查閱第 17 頁。
- Soldering conditions and recommended land size are given in page 22. 焊接條件及推薦安裝尺寸請查閱第 22 頁。
- Please refer to page 18 for the minimum package quantity. 最小包裝數量請查閱第 18 頁。
- Please refer to page 14 for the Part Number System. 產品編碼規則請查閱第 14 頁。

Note: All design and specifications are for reference only and is subject to change without prior notice. If any doubt about safety for your application, please contact us immediately for technical assistance before purchase.

注：以上所提供的設計及特性參數僅供參考，任何修改不作預先通知。如果在使用上有疑問，請在採購前與我們聯繫，以便提供技術上的協助。

CAT.2023/V2

MV Series

CHIP TYPE, HIGH VOLTAGE/LONG LIFE

貼片式, 高壓長壽命品



- Operating with wide temperature range -55~+105°C
適用於 -55~+105°C 的寬溫範圍
- High voltage, low ESR, high ripple current
高電壓, 低阻抗, 高紋波電流
- Endurance 3000 hours
耐久性 3000 小時
- RoHS & REACH compliant, Halogen-free
符合 RoHS 與 REACH, 無鹵

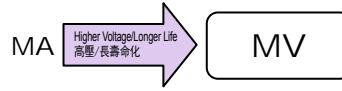

□ SPECIFICATIONS 特性表

Items 項目	Characteristics 主要特性					
Category Temperature Range 工作溫度範圍	-55 ~ +105°C					
Voltage Range 額定工作電壓範圍	16 ~ 125V					
Capacitance Range 靜電容量範圍	5.6 ~ 680µF					
Capacitance Tolerance 靜電容量允許偏差	±20% at 120Hz, 20°C					
Leakage Current 漏電流 (*1)	≤Specified value (after 2 minutes application of rated voltage at 20°C). ≤規範值 (20°C 環境中施加額定工作電壓 2 分鐘後)。					
Dissipation Factor (tan δ) 損耗角正切	≤Specified value at 120Hz, 20°C. ≤規範值 (在 20°C 120Hz 環境下)。					
ESR 阻抗值 (*2)	≤Specified value at 100KHz, 20°C. ≤規範值 (在 20°C 100KHz 環境下)。					
Stability at Low Temperature 低溫特性	Measurement frequency 測試頻率: 100KHz					
	<table border="1"> <tr> <td>Impedance Ratio 阻抗比 ZT/Z20 (max.)</td> <td>Z(+105°C)/Z(20°C)</td> <td>≤1.25</td> </tr> <tr> <td></td> <td>Z(-55°C)/Z(20°C)</td> <td>≤1.25</td> </tr> </table>	Impedance Ratio 阻抗比 ZT/Z20 (max.)	Z(+105°C)/Z(20°C)	≤1.25		Z(-55°C)/Z(20°C)
Impedance Ratio 阻抗比 ZT/Z20 (max.)	Z(+105°C)/Z(20°C)	≤1.25				
	Z(-55°C)/Z(20°C)	≤1.25				
Damp Heat (Steady State) 穩態濕熱	When the capacitors are restored to 20°C after the rated voltage is applied for 1000 hours at 60°C, 90% RH, they meet the characteristics listed below. 在 60°C 和相對濕度 90% 環境下施加額定工作電壓 1000 小時並冷卻至 20°C 後, 電容器的特性符合下表的要求。					
	Capacitance Change 靜電容量變化率	Within ±20% of initial value 為初始值的±20%以內 (*3)				
	Dissipation Factor 損耗角正切	150% or less of initial specified value 不大於規範值的 150%				
	ESR 阻抗值 (*2)	150% or less of initial specified value 不大於規範值的 150%				
	Leakage Current 漏電流	Initial specified value or less 不大於規範值				
Endurance 耐久性	After 3000 hours application of the rated voltage at 105°C, they meet the characteristics listed below. 在 105°C 環境中施加額定工作電壓 3000 小時後, 電容器的特性符合下表的要求。					
	Capacitance Change 靜電容量變化率	Within ±20% of initial value 為初始值的±20%以內 (*3)				
	Dissipation Factor 損耗角正切	150% or less of initial specified value 不大於規範值的 150%				
	ESR 阻抗值 (*2)	150% or less of initial specified value 不大於規範值的 150%				
	Leakage Current 漏電流	Initial specified value or less 不大於規範值				
Resistance to Soldering Heat 耐焊接熱特性 <small>(Please refer page 22 for soldering conditions) (焊接條件請查閱第 22 頁)</small>	After reflow soldering and restored at room temperature, they meet the characteristics listed below. 經過回流焊並冷卻至室溫後, 電容器的特性符合下表的要求。					
	Capacitance Change 靜電容量變化率	Within ±10% of initial value 初始值的±10%以內 (*3)				
	Dissipation Factor 損耗角正切	130% or less of initial specified value 不大於規範值的 130%				
	ESR 阻抗值 (*2)	130% or less of initial specified value 不大於規範值的 130%				
	Leakage Current 漏電流	Initial specified value or less 不大於規範值				
Marking 標識	Red print on the case top. 鋁殼頂部紅色字體印刷。					

(*1) If any doubt arises, measure the leakage current after the voltage treatment of applying DC rated voltage continuously to the capacitor for 120 minutes at 105°C.
如未能確定, 在 105°C 環境下連續施加額定工作電壓 120 分鐘後測量漏電流。

(*2) Should be measured at both of the terminal ends closest where the terminals protrude through the plastic platform.
測試應為靠近突出底座兩個端子的末端。

(*3) The value before test of examination of resistance to soldering.
焊接測試前的值。

□ DRAWING 外形圖 (Unit: mm)

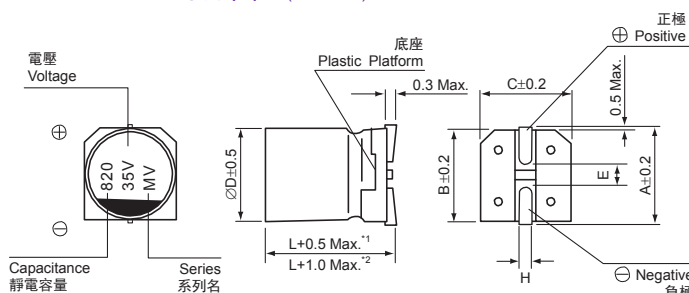

*1. Applicable to Ø6.3 and Ø8 適用於Ø6.3和Ø8
*2. Applicable to Ø10 and above 適用於Ø10和Ø10以上

Dimension table in next page.
尺寸表見下一頁。

Note: All design and specifications are for reference only and is subject to change without prior notice. If any doubt about safety for your application, please contact us immediately for technical assistance before purchase.

注: 以上所提供的設計及特性參數僅供參考, 任何修改不作預先通知。如果在使用上有疑問, 請在採購前與我們聯繫, 以便提供技術上的協助。

CAT.2023/V2

MV Series

□ DIMENSIONS 尺寸表 (Unit: mm)

∅D × L	6.3 × 4/4.2	6.3 × 6/6.5	6.3 × 7.7/9	8 × 7/9/10	8 × 12	10 × 8/10	10 × 12.5/12.7/13
A	7.3	7.3	7.3	9.0	9.0	11.0	11.0
B	6.6	6.6	6.6	8.3	8.3	10.3	10.3
C	6.6	6.6	6.6	8.3	8.3	10.3	10.3
E	2.1	2.1	2.1	3.2	3.2	4.6	4.6
L	4.0/4.2	6.0/6.5	7.7/9.0	7.0/9.0/10.0	12.0	8.0/10.0	12.5/12.7/13.0
H	0.5~0.8	0.5~0.8	0.5~0.8	0.8~1.1	0.8~1.1	0.8~1.1	0.8~1.1

□ DIMENSIONS & STANDARD RATINGS 規格尺寸及標準參數

WV (V)		16 (1C)					20 (1D)				
Cap. 容量 (μF)	Parameter 參數	Case size ∅D×L (mm) 尺寸	Dissipation factor (tan δ) 損耗角正切	Leakage current (μA) 漏電流	ESR (mΩ) max. 20°C, 100KHz 阻抗值	Ripple current (mA rms) 105°C, 100KHz 紋波電流	Case size ∅D×L (mm) 尺寸	Dissipation factor (tan δ) 損耗角正切	Leakage current (μA) 漏電流	ESR (mΩ) max. 20°C, 100KHz 阻抗值	Ripple current (mA rms) 105°C, 100KHz 紋波電流
47	470						6.3 × 6	0.12	188	55	1000
56	560	6.3 × 6	0.12	179	50	1000	6.3 × 6	0.12	224	48	1300
68	680						8 × 7	0.12	272	45	1300
82	820	6.3 × 6	0.12	262	47	1300					
100	101	8 × 7	0.12	320	36	1500	8 × 7	0.12	400	42	1400
150	151	8 × 7	0.12	480	34	1700	8 × 10 (10 × 8)	0.12 (0.12)	600 (600)	28 (33)	2000 (1900)
180	181						10 × 8	0.12	720	25	3100
220	221	8 × 10 (10 × 8)	0.12 (0.12)	704 (704)	27 (31)	2000 (2000)	8 × 10 (8 × 12)	0.12 (0.12)	880 (880)	22 (27)	3700 (2300)
270	271	8 × 10 (8 × 12) (10 × 8)	0.12 (0.12) (0.12)	864 (864) (864)	21 (26) (24)	3800 (2300) (3200)	8 × 12 (10 × 10)	0.12 (0.12)	1080 (1080)	21 (27)	4000 (2300)
330	331	10 × 10	0.12	1056	26	2400	10 × 10 (10 × 12.7)	0.12 (0.12)	1320 (1320)	22 (26)	3800 (2700)
390	391	8 × 12	0.12	1248	20	4100					
470	471	10 × 10 (8 × 12)	0.12 (0.12)	1504 (1504)	21 (25)	3900 (2800)	10 × 12.7	0.12	1880	20	4300
680	681	10 × 12.7	0.12	2176	19	4400					

WV (V)		25 (1E)					35 (1V)				
Cap. 容量 (μF)	Parameter 參數	Case size ∅D×L (mm) 尺寸	Dissipation factor (tan δ) 損耗角正切	Leakage current (μA) 漏電流	ESR (mΩ) max. 20°C, 100KHz 阻抗值	Ripple current (mA rms) 105°C, 100KHz 紋波電流	Case size ∅D×L (mm) 尺寸	Dissipation factor (tan δ) 損耗角正切	Leakage current (μA) 漏電流	ESR (mΩ) max. 20°C, 100KHz 阻抗值	Ripple current (mA rms) 105°C, 100KHz 紋波電流
18	180						6.3 × 6	0.12	126	64	900
22	220						6.3 × 4.2 (6.3 × 6) (6.3 × 9)	0.12 (0.12) (0.12)	154 (154) (154)	60 (50) (50)	1100 (1300) (1200)
27	270						8 × 7	0.12	189	55	1200
33	330	6.3 × 6	0.12	165	60	1000					
39	390						8 × 7	0.12	273	52	1400
47	470	6.3 × 4 (6.3 × 6)	0.12 (0.12)	235 (235)	58 (49)	1200 (1300)	6.3 × 6.5 (6.3 × 9)	0.12 (0.12)	329 (329)	50 (49)	1500 (1600)
56	560	8 × 7	0.12	280	50	1300	6.3 × 6.5 (8 × 10)	0.12 (0.12)	392 (392)	49 (31)	1600 (1900)
68	680						10 × 8	0.12	476	37	1800
82	820	8 × 7	0.12	410	47	1400	8 × 10 (8 × 12) (10 × 8)	0.12 (0.12) (0.12)	574 (574) (574)	24 (29) (27)	3600 (2200) (3000)
100	101	6.3 × 4 (6.3 × 5.7) (6.3 × 6.5) (6.3 × 7.7) (8 × 9)	0.12 (0.12) (0.12) (0.12) (0.12)	500 (500) (500) (500) (500)	35 (35) (35) (35) (29)	1400 (1400) (1400) (1400) (1900)	6.3 × 7.7 (6.3 × 9) (6.3 × 12) (8 × 9)	0.12 (0.12) (0.12) (0.12)	700 (700) (700) (700)	35 (35) (29) (27)	1450 (1450) (2850) (3600)
120	121	8 × 9 (8 × 10) (10 × 8)	0.12 (0.12) (0.12)	600 (600) (600)	29 (35) (35)	1900 (1900) (1800)	8 × 12 (10 × 10)	0.12 (0.12)	840 (840)	23 (24)	3800 (3700)
150	151	8 × 10 (8 × 12) (10 × 8)	0.12 (0.12) (0.12)	750 (750) (750)	23 (28) (26)	3600 (2200) (3000)	8 × 9 (10 × 12.7)	0.12 (0.12)	1050 (1050)	23 (28)	2400 (2600)
180	181	10 × 10	0.12	900	28	2300	10 × 12.7	0.12	1260	22	4100
220	221	6.3 × 9 (6.3 × 6.5) (8 × 12)	0.12 (0.12) (0.12)	1100 (1100) (1100)	26 (22) (22)	3000 (3800) (3800)	8 × 12 (10 × 12.5)	0.12 (0.12)	1540 (1540)	22 (20)	2800 (4500)
270	271	10 × 10 (10 × 12.7)	0.12 (0.12)	1350 (1350)	23 (27)	3700 (2700)	10 × 10.5	0.12	1890	20	4500
330	331	8 × 12 (10 × 10.5) (10 × 12.5)	0.12 (0.12) (0.12)	1650 (1650) (1650)	26 (25) (25)	4800 (5000) (5000)	8 × 12 (10 × 10.5)	0.12 (0.12)	1540 (1540)	22 (20)	4100 (4500)
390	391	10 × 12.7	0.12	1950	21	4200					
470	471	8 × 12 (10 × 13)	0.12 (0.12)	2350 (2350)	20 (9)	4100 (6100)	10 × 12.5	0.12	3290	20	5900
560	561	10 × 10.5	0.12	2800	21	4500					
680	681	8 × 12.5 (10 × 12.5)	0.12 (0.12)	3400 (3400)	16 (16)	5600 (5600)					

Note: All design and specifications are for reference only and is subject to change without prior notice. If any doubt about safety for your application, please contact us immediately for technical assistance before purchase.

注：以上所提供的設計及特性參數僅供參考，任何修改不作預先通知。如果在使用上有疑問，請在採購前與我們聯繫，以便提供技術上的協助。

CAT.2023/V2

MV Series

□ DIMENSIONS & STANDARD RATINGS 規格尺寸及標準參數

WV (V)		50 (1H)					63 (1J)				
Cap. 容量 (μF)	Parameter 參數	Case size ØD×L (mm) 尺寸	Dissipation factor (tan δ) 損耗角正切	Leakage current (μA) 漏電流	ESR (mΩ) max. 20°C, 100KHz 阻抗值	Ripple current (mA rms) 105°C, 100KHz 紋波電流	Case size ØD×L (mm) 尺寸	Dissipation factor (tan δ) 損耗角正切	Leakage current (μA) 漏電流	ESR (mΩ) max. 20°C, 100KHz 阻抗值	Ripple current (mA rms) 105°C, 100KHz 紋波電流
5.6	5R6						6.3 × 6	0.12	71	105	700
8.2	8R2	6.3 × 6	0.12	82	81	800	6.3 × 6	0.12	103	56	1200
10	100	6.3 × 4.2	0.12	100	75	1100	8 × 7	0.12	126	75	1000
12	120	6.3 × 6	0.12	120	55	1200	8 × 7	0.12	151	70	1100
15	150	8 × 7	0.12	150	63	1100					
22	220	8 × 7	0.12	220	60	1300	8 × 10 (10 × 8)	0.12 (0.12)	277 (277)	37 (56)	1700 (1400)
27	270						8 × 10 (10 × 12) (10 × 8)	0.12 (0.12) (0.12)	340 (340) (340)	30 (35) (38)	3200 (2000) (2500)
33	330	8 × 10 (10 × 8)	0.12 (0.12)	330 (330)	36 (49)	1700 (1500)	10 × 10	0.12	416	31	2200
39	390	8 × 12	0.12	390	34	2000	8 × 12	0.12	491	29	3400
47	470	8 × 9 (8 × 10) (10 × 8)	0.12 (0.12) (0.12)	470 (470) (470)	29 (29) (37)	3300 (3300) (2600)	8 × 12 (10 × 10) (10 × 12.7)	0.12 (0.12) (0.12)	592 (592) (592)	27 (30) (30)	3800 (3300) (2500)
56	560	8 × 12	0.12	560	28	3400	10 × 12.7	0.12	706	28	3400
68	680	10 × 10 (10 × 12.7)	0.12 (0.12)	680 (680)	29 (29)	3400 (2600)					
100	101	8 × 9 (10 × 12.7)	0.12 (0.12)	1000 (1000)	28 (27)	3300 (3600)	10 × 12.5	0.12	1260	28	3800
220	221	10 × 12.5	0.12	2200	26	3800					

WV (V)		80 (1K)					100 (2A)				
Cap. 容量 (μF)	Parameter 參數	Case size ØD×L (mm) 尺寸	Dissipation factor (tan δ) 損耗角正切	Leakage current (μA) 漏電流	ESR (mΩ) max. 20°C, 100KHz 阻抗值	Ripple current (mA rms) 105°C, 100KHz 紋波電流	Case size ØD×L (mm) 尺寸	Dissipation factor (tan δ) 損耗角正切	Leakage current (μA) 漏電流	ESR (mΩ) max. 20°C, 100KHz 阻抗值	Ripple current (mA rms) 105°C, 100KHz 紋波電流
6.8	6R8						8 × 10	0.12	136	48	1500
10	100	8 × 10	0.12	160	43	1600	8 × 12	0.12	200	45	1700
12	120	8 × 12	0.12	192	41	1800	10 × 10	0.12	240	42	1900
15	150	10 × 10	0.12	240	39	1900					
18	180						10 × 12.7	0.12	360	41	2100
22	220	10 × 12.7	0.12	352	38	2200					

WV (V)		125 (2B)				
Cap. 容量 (μF)	Parameter 參數	Case size ØD×L (mm) 尺寸	Dissipation factor (tan δ) 損耗角正切	Leakage current (μA) 漏電流	ESR (mΩ) max. 20°C, 100KHz 阻抗值	Ripple current (mA rms) 105°C, 100KHz 紋波電流
6.8	6R8	8 × 10	0.12	170	93	1100
8.2	8R2	8 × 12	0.12	205	84	1300
12	120	10 × 10	0.12	300	69	1400
15	150	10 × 12.7	0.12	375	48	2000

- Taping specifications are given in page 17. 編帶標準請查閱第 17 頁。
- Soldering conditions and recommended land size are given in page 22. 焊接條件及推薦安裝尺寸請查閱第 22 頁。
- Please refer to page 18 for the minimum package quantity. 最小包裝數量請查閱第 18 頁。
- Please refer to page 14 for the Part Number System. 產品編碼規則請查閱第 14 頁。

Note: All design and specifications are for reference only and is subject to change without prior notice. If any doubt about safety for your application, please contact us immediately for technical assistance before purchase.

注：以上所提供的設計及特性參數僅供參考，任何修改不作預先通知。如果在使用上有疑問，請在採購前與我們聯繫，以便提供技術上的協助。

CAT.2023/V2

PA Series

RADIAL LEAD TYPE, STANDARD

插件式，標準品

- Operating with wide temperature range -55~+105°C
適用於 -55~+105°C 的寬溫範圍
- Low ESR, high ripple current
低阻抗，高紋波電流
- Endurance 2000 hours
耐久性 2000 小時
- RoHS & REACH compliant, Halogen-free
符合 RoHS 與 REACH，無鹵

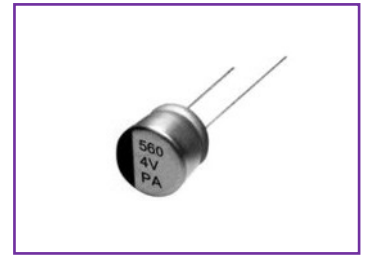
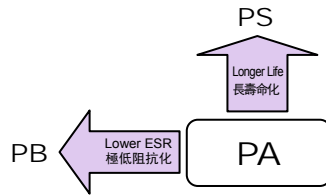

□ SPECIFICATIONS 特性表

Items 項目	Characteristics 主要特性								
Category Temperature Range 工作溫度範圍	-55 ~ +105°C								
Voltage Range 額定工作電壓範圍	2.5 ~ 25V								
Capacitance Range 靜電容量範圍	6.8 ~ 1500µF								
Capacitance Tolerance 靜電容量允許偏差	±20% at 120Hz, 20°C								
Leakage Current 漏電流 (*1)	≤Specified value (after 2 minutes application of rated voltage at 20°C). ≤規範值(在 20°C 環境中施加額定工作電壓 2 分鐘後)。								
Dissipation Factor (tan δ) 損耗角正切	≤Specified value at 120Hz, 20°C. ≤規範值(在 20°C 120Hz 環境下)。								
ESR 阻抗值 (*2)	≤Specified value at 100KHz, 20°C. ≤規範值(在 20°C 100KHz 環境下)。								
Stability at Low Temperature 低溫特性	Measurement frequency 測試頻率: 100KHz <table border="1"> <tr> <td>Impedance Ratio 阻抗比 ZT/Z20 (max.)</td> <td>Z(+105°C)/Z(20°C)</td> <td>≤1.25</td> </tr> <tr> <td></td> <td>Z(-55°C)/Z(20°C)</td> <td>≤1.25</td> </tr> </table>	Impedance Ratio 阻抗比 ZT/Z20 (max.)	Z(+105°C)/Z(20°C)	≤1.25		Z(-55°C)/Z(20°C)	≤1.25		
Impedance Ratio 阻抗比 ZT/Z20 (max.)	Z(+105°C)/Z(20°C)	≤1.25							
	Z(-55°C)/Z(20°C)	≤1.25							
Damp Heat (Steady State) 穩態濕熱	When the capacitors are restored to 20°C after the rated voltage is applied for 1000 hours at 60°C, 90% RH, they meet the characteristics listed below. 在 60°C 和相對濕度 90%環境下施加額定工作電壓 1000 小時並冷卻至 20°C 後，電容器的特性符合下表的要求。 <table border="1"> <tr> <td>Capacitance Change 靜電容量變化率</td> <td>Within ±20% of initial value 為初始值的±20%以內 (*3)</td> </tr> <tr> <td>Dissipation Factor 損耗角正切</td> <td>150% or less of initial specified value 不大於規範值的 150%</td> </tr> <tr> <td>ESR 阻抗值 (*2)</td> <td>150% or less of initial specified value 不大於規範值的 150%</td> </tr> <tr> <td>Leakage Current 漏電流</td> <td>Initial specified value or less 不大於規範值</td> </tr> </table>	Capacitance Change 靜電容量變化率	Within ±20% of initial value 為初始值的±20%以內 (*3)	Dissipation Factor 損耗角正切	150% or less of initial specified value 不大於規範值的 150%	ESR 阻抗值 (*2)	150% or less of initial specified value 不大於規範值的 150%	Leakage Current 漏電流	Initial specified value or less 不大於規範值
Capacitance Change 靜電容量變化率	Within ±20% of initial value 為初始值的±20%以內 (*3)								
Dissipation Factor 損耗角正切	150% or less of initial specified value 不大於規範值的 150%								
ESR 阻抗值 (*2)	150% or less of initial specified value 不大於規範值的 150%								
Leakage Current 漏電流	Initial specified value or less 不大於規範值								
Endurance 耐久性	After 2000 hours application of the rated voltage at 105°C, they meet the characteristics listed below. 在 105°C 環境中施加額定工作電壓 2000 小時後，電容器的特性符合下表的要求。 <table border="1"> <tr> <td>Capacitance Change 靜電容量變化率</td> <td>Within ±20% of initial value 為初始值的±20%以內 (*3)</td> </tr> <tr> <td>Dissipation Factor 損耗角正切</td> <td>150% or less of initial specified value 不大於規範值的 150%</td> </tr> <tr> <td>ESR 阻抗值 (*2)</td> <td>150% or less of initial specified value 不大於規範值的 150%</td> </tr> <tr> <td>Leakage Current 漏電流</td> <td>Initial specified value or less 不大於規範值</td> </tr> </table>	Capacitance Change 靜電容量變化率	Within ±20% of initial value 為初始值的±20%以內 (*3)	Dissipation Factor 損耗角正切	150% or less of initial specified value 不大於規範值的 150%	ESR 阻抗值 (*2)	150% or less of initial specified value 不大於規範值的 150%	Leakage Current 漏電流	Initial specified value or less 不大於規範值
Capacitance Change 靜電容量變化率	Within ±20% of initial value 為初始值的±20%以內 (*3)								
Dissipation Factor 損耗角正切	150% or less of initial specified value 不大於規範值的 150%								
ESR 阻抗值 (*2)	150% or less of initial specified value 不大於規範值的 150%								
Leakage Current 漏電流	Initial specified value or less 不大於規範值								
Resistance to Soldering Heat 耐焊接熱特性 (Please refer page 9 for soldering conditions) (焊接條件請查閱第 12 頁)	After reflow soldering and restored at room temperature, they meet the characteristics listed below. 經過回流焊並冷卻至室溫後，電容器的特性符合下表的要求。 <table border="1"> <tr> <td>Capacitance Change 靜電容量變化率</td> <td>Within ±10% of initial value 初始值的±10%以內 (*3)</td> </tr> <tr> <td>Dissipation Factor 損耗角正切</td> <td>130% or less of initial specified value 不大於規範值的 130%</td> </tr> <tr> <td>ESR 阻抗值 (*2)</td> <td>130% or less of initial specified value 不大於規範值的 130%</td> </tr> <tr> <td>Leakage Current 漏電流</td> <td>Initial specified value or less 不大於規範值</td> </tr> </table>	Capacitance Change 靜電容量變化率	Within ±10% of initial value 初始值的±10%以內 (*3)	Dissipation Factor 損耗角正切	130% or less of initial specified value 不大於規範值的 130%	ESR 阻抗值 (*2)	130% or less of initial specified value 不大於規範值的 130%	Leakage Current 漏電流	Initial specified value or less 不大於規範值
Capacitance Change 靜電容量變化率	Within ±10% of initial value 初始值的±10%以內 (*3)								
Dissipation Factor 損耗角正切	130% or less of initial specified value 不大於規範值的 130%								
ESR 阻抗值 (*2)	130% or less of initial specified value 不大於規範值的 130%								
Leakage Current 漏電流	Initial specified value or less 不大於規範值								
Marking 標識	Red print on the case top. 鋁殼頂部紅色字體印刷。								

(*1) If any doubt arises, measure the leakage current after the voltage treatment of applying DC rated voltage continuously to the capacitor for 120 minutes at 105°C.
如未能確定，在 105°C 環境下連續施加額定工作電壓 120 分鐘後測量漏電流。
 (*2) Should be measured at both of the terminal ends closest to the capacitor body.
測試應為靠近兩個端子的末端。
 (*3) The value before test of examination of resistance to soldering.
焊接測試前的值。

□ DRAWING 外形圖 (Unit: mm)

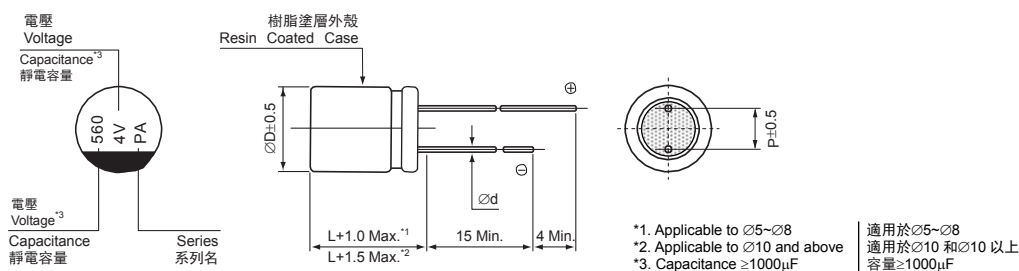

Dimension table in next page.
尺寸表見下一頁。

Note: All design and specifications are for reference only and is subject to change without prior notice. If any doubt about safety for your application, please contact us immediately for technical assistance before purchase.

注: 以上所提供的設計及特性參數僅供參考，任何修改不作預先通知。如果在使用上有疑問，請在採購前與我們聯繫，以便提供技術上的協助。

CAT.2023/V2

PA Series

□ DIMENSIONS 尺寸表 (Unit: mm)

∅D × L	5 × 7/9/11	6.3 × 6/7	6.3 × 8/9	6.3 × 10.5/11/12	8 × 7/8/9	8 × 11/12	10 × 8/10/13
P	2.0	2.5	2.5	2.5	3.5	3.5	5.0
∅d	0.5	0.6	0.6	0.6	0.6	0.6	0.6
L	7.0/9.0/11.0	6.0/7.0	8.0/9.0	10.5/11.0/12.0	7.0/8.0/9.0	11.0/12.0	8.0/10.0/13.0

□ DIMENSIONS & STANDARD RATINGS 規格尺寸及標準參數

WV (V)		2.5 (0E)					4 (0G)				
Cap. 容量 (μF)	Parameter 參數	Case size ∅D×L (mm) 尺寸	Dissipation factor (tan δ) 損耗角正切	Leakage current (μA) 漏電流	ESR (mΩ) max. 20°C, 100KHz 阻抗值	Ripple current (mA rms) 105°C, 100KHz 紋波電流	Case size ∅D×L (mm) 尺寸	Dissipation factor (tan δ) 損耗角正切	Leakage current (μA) 漏電流	ESR (mΩ) max. 20°C, 100KHz 阻抗值	Ripple current (mA rms) 105°C, 100KHz 紋波電流
		270	271						6.3 × 9 (6.3 × 10.5)	0.08 (0.08)	216 (216)
330	331	6.3 × 9	0.08	165	7	5600					
390	391	6.3 × 10.5	0.08	195	20	3200	6.3 × 10.5	0.08	312	24	3300
560	561	6.3 × 9	0.08	280	7	5600	8 × 9 (8 × 12)	0.08 (0.08)	448 (448)	7 (7)	5200 (5500)
680	681	8 × 9	0.08	340	7	4800	8 × 12	0.08	544	6	6200
820	821	6.3 × 9	0.08	410	7	5600	10 × 13	0.08	656	6	6500
1000	102	10 × 13	0.08	500	6	6500	10 × 13	0.08	800	6	6640
1200	122	10 × 13	0.08	600	8	5300	10 × 13	0.08	960	8	5600
1500	152	8 × 12	0.08	750	7	6100					

WV (V)		6.3 (0J)					10 (1A)				
Cap. 容量 (μF)	Parameter 參數	Case size ∅D×L (mm) 尺寸	Dissipation factor (tan δ) 損耗角正切	Leakage current (μA) 漏電流	ESR (mΩ) max. 20°C, 100KHz 阻抗值	Ripple current (mA rms) 105°C, 100KHz 紋波電流	Case size ∅D×L (mm) 尺寸	Dissipation factor (tan δ) 損耗角正切	Leakage current (μA) 漏電流	ESR (mΩ) max. 20°C, 100KHz 阻抗值	Ripple current (mA rms) 105°C, 100KHz 紋波電流
		47	470						6.3 × 10.5	0.08	94
68	680						6.3 × 10.5	0.08	136	25	2900
100	101						6.3 × 8 (6.3 × 10.5)	0.08 (0.08)	200 (200)	25 (25)	2900 (2900)
150	151						6.3 × 10.5	0.08	300	25	2900
220	221	5 × 7 (6.3 × 10.5)	0.08 (0.08)	277 (277)	20 (20)	3000 (3200)	6.3 × 7	0.08	440	12	3150
270	271						8 × 12	0.08	540	8	4900
330	331	6.3×10.5	0.08	416	24	3300					
470	471	8 × 9 (8 × 12)	0.08 (0.08)	592 (592)	7 (7)	5200 (5500)	5 × 11 (8 × 8) (10 × 13)	0.08 (0.08) (0.08)	940 (940) (940)	16 (12) (7)	3000 (5300) (5700)
560	561						10 × 13	0.08	1120	7	5900
680	681	10 × 13	0.08	857	6	6300	10 × 13	0.08	1360	7	6100

WV (V)		16 (1C)					20 (1D)				
Cap. 容量 (μF)	Parameter 參數	Case size ∅D×L (mm) 尺寸	Dissipation factor (tan δ) 損耗角正切	Leakage current (μA) 漏電流	ESR (mΩ) max. 20°C, 100KHz 阻抗值	Ripple current (mA rms) 105°C, 100KHz 紋波電流	Case size ∅D×L (mm) 尺寸	Dissipation factor (tan δ) 損耗角正切	Leakage current (μA) 漏電流	ESR (mΩ) max. 20°C, 100KHz 阻抗值	Ripple current (mA rms) 105°C, 100KHz 紋波電流
		22	220						6.3 × 6	0.12	88
39	390						8 × 7	0.12	156	45	2000
47	470						8 × 7	0.12	188	45	2000
56	560						10 × 8	0.12	224	40	2400
68	680						10 × 8	0.12	272	40	2600
82	820						10 × 8	0.12	328	40	2600
100	101	5 × 8 (6.3 × 7) (6.3 × 10.5)	0.08 (0.08) (0.08)	320 (320) (320)	25 (25) (24)	2350 (2600) (2900)	8 × 12	0.12	400	22	3320
120	121						10 × 10	0.12	480	35	2800
150	151						10 × 13	0.12	600	20	4320
180	181	5 × 9 (8 × 8) (8 × 12)	0.08 (0.08) (0.08)	576 (576) (576)	12 (10) (9)	2750 (4200) (5000)					
220	221	6.3 × 8 (6.3 × 12)	0.08 (0.08)	704 (704)	12 (12)	3800 (4400)					
270	271	8 × 8 (8 × 12)	0.08 (0.08)	864 (864)	10 (9)	4600 (5100)					
330	331	10 × 13	0.08	1056	9	6100					
470	471	10 × 13	0.08	1504	9	6100					

Note: All design and specifications are for reference only and is subject to change without prior notice. If any doubt about safety for your application, please contact us immediately for technical assistance before purchase.

注：以上所提供的設計及特性參數僅供參考，任何修改不作預先通知。如果在使用上有疑問，請在採購前與我們聯繫，以便提供技術上的協助。

CAT.2023/V2

PA Series

□ DIMENSIONS & STANDARD RATINGS 規格尺寸及標準參數

Cap. 容量 (μ F)	Parameter 參數	25 (1E)				
		Case size \varnothing D \times L (mm) 尺寸	Dissipation factor (tan δ) 損耗角正切	Leakage current (μ A) 漏電流	ESR (m Ω) max. 20°C, 100KHz 阻抗值	Ripple current (mA rms) 105°C, 100KHz 紋波電流
6.8	6R8	6.3 \times 6	0.12	34	80	1200
10	100	6.3 \times 6	0.12	50	65	1500
22	220	8 \times 7	0.12	110	60	1500
33	330	8 \times 7	0.12	165	50	1800
47	470	6.3 \times 7 (10 \times 13)	0.12 (0.12)	235 (235)	49 (30)	1300 (3000)
56	560	10 \times 13	0.12	280	28	3800
100	101	5 \times 11 (6.3 \times 8) (6.3 \times 11)	0.12 (0.12) (0.12)	500 (500) (500)	30 (30) (30)	2500 (2500) (3000)
220	221	6.3 \times 12 (8 \times 11)	0.12 (0.12)	1100 (1100)	20 (18)	4000 (4300)

- Please refer to page 21 about the taped or cutting product spec. 編帶與剪腳標準請查閱第 21 頁。
- Please refer to page 18 for the minimum package quantity. 最小包裝數量請查閱第 18 頁。
- Please refer to page 14 for the Part Number System. 產品編碼規則請查閱第 14 頁。

Note: All design and specifications are for reference only and is subject to change without prior notice. If any doubt about safety for your application, please contact us immediately for technical assistance before purchase.

注：以上所提供的設計及特性參數僅供參考，任何修改不作預先通知。如果在使用上有疑問，請在採購前與我們聯繫，以便提供技術上的協助。

CAT.2023/V2

PB Series

RADIAL LEAD TYPE, HIGHER CAPACITANCE

插件式，大容量品

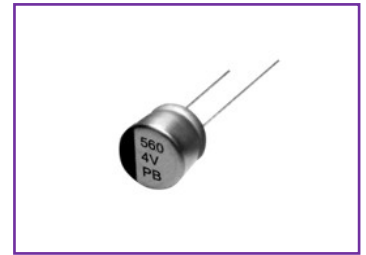

- Operating with wide temperature range -55~+105°C
適用於 -55~+105°C 的寬溫範圍
- Higher capacitance, ultra-low ESR, high ripple current
更大容量，極低阻抗，高紋波電流
- Endurance 2000 hours
耐久性 2000 小時
- RoHS & REACH compliant, Halogen-free
符合 RoHS 與 REACH，無鹵

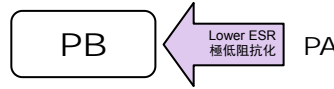

□ SPECIFICATIONS 特性表

Items 項目	Characteristics 主要特性								
Category Temperature Range 工作溫度範圍	-55 ~ +105°C								
Voltage Range 額定工作電壓範圍	2.5 ~ 16V								
Capacitance Range 靜電容量範圍	100 ~ 2200µF								
Capacitance Tolerance 靜電容量允許偏差	±20% at 120Hz, 20°C								
Leakage Current 漏電流 (*1)	≤Specified value (after 2 minutes application of rated voltage at 20°C). ≤規範值(在 20°C 環境中施加額定工作電壓 2 分鐘後)。								
Dissipation Factor (tan δ) 損耗角正切	≤Specified value at 120Hz, 20°C. ≤規範值(在 20°C 120Hz 環境下)。								
ESR 阻抗值 (*2)	≤Specified value at 100KHz, 20°C. ≤規範值(在 20°C 100KHz 環境下)。								
Stability at Low Temperature 低溫特性	Measurement frequency 測試頻率: 100KHz <table border="1"> <tr> <td>Impedance Ratio 阻抗比 ZT/Z20 (max.)</td> <td>Z(+105°C)/Z(20°C) Z(-55°C)/Z(20°C)</td> <td>≤1.25 ≤1.25</td> </tr> </table>	Impedance Ratio 阻抗比 ZT/Z20 (max.)	Z(+105°C)/Z(20°C) Z(-55°C)/Z(20°C)	≤1.25 ≤1.25					
Impedance Ratio 阻抗比 ZT/Z20 (max.)	Z(+105°C)/Z(20°C) Z(-55°C)/Z(20°C)	≤1.25 ≤1.25							
Damp Heat (Steady State) 穩態濕熱	When the capacitors are restored to 20°C after the rated voltage is applied for 1000 hours at 60°C, 90% RH, they meet the characteristics listed below. 在 60°C 和相對濕度 90%環境下施加額定工作電壓 1000 小時並冷卻至 20°C 後，電容器的特性符合下表的要求。 <table border="1"> <tr> <td>Capacitance Change 靜電容量變化率</td> <td>Within ±20% of initial value 為初始值的±20%以內 (*3)</td> </tr> <tr> <td>Dissipation Factor 損耗角正切</td> <td>150% or less of initial specified value 不大於規範值的 150%</td> </tr> <tr> <td>ESR 阻抗值 (*2)</td> <td>150% or less of initial specified value 不大於規範值的 150%</td> </tr> <tr> <td>Leakage Current 漏電流</td> <td>Initial specified value or less 不大於規範值</td> </tr> </table>	Capacitance Change 靜電容量變化率	Within ±20% of initial value 為初始值的±20%以內 (*3)	Dissipation Factor 損耗角正切	150% or less of initial specified value 不大於規範值的 150%	ESR 阻抗值 (*2)	150% or less of initial specified value 不大於規範值的 150%	Leakage Current 漏電流	Initial specified value or less 不大於規範值
Capacitance Change 靜電容量變化率	Within ±20% of initial value 為初始值的±20%以內 (*3)								
Dissipation Factor 損耗角正切	150% or less of initial specified value 不大於規範值的 150%								
ESR 阻抗值 (*2)	150% or less of initial specified value 不大於規範值的 150%								
Leakage Current 漏電流	Initial specified value or less 不大於規範值								
Endurance 耐久性	After 2000 hours application of the rated voltage at 105°C, they meet the characteristics listed below. 在 105°C 環境中施加額定工作電壓 2000 小時後，電容器的特性符合下表的要求。 <table border="1"> <tr> <td>Capacitance Change 靜電容量變化率</td> <td>Within ±20% of initial value 為初始值的±20%以內 (*3)</td> </tr> <tr> <td>Dissipation Factor 損耗角正切</td> <td>150% or less of initial specified value 不大於規範值的 150%</td> </tr> <tr> <td>ESR 阻抗值 (*2)</td> <td>150% or less of initial specified value 不大於規範值的 150%</td> </tr> <tr> <td>Leakage Current 漏電流</td> <td>Initial specified value or less 不大於規範值</td> </tr> </table>	Capacitance Change 靜電容量變化率	Within ±20% of initial value 為初始值的±20%以內 (*3)	Dissipation Factor 損耗角正切	150% or less of initial specified value 不大於規範值的 150%	ESR 阻抗值 (*2)	150% or less of initial specified value 不大於規範值的 150%	Leakage Current 漏電流	Initial specified value or less 不大於規範值
Capacitance Change 靜電容量變化率	Within ±20% of initial value 為初始值的±20%以內 (*3)								
Dissipation Factor 損耗角正切	150% or less of initial specified value 不大於規範值的 150%								
ESR 阻抗值 (*2)	150% or less of initial specified value 不大於規範值的 150%								
Leakage Current 漏電流	Initial specified value or less 不大於規範值								
Resistance to Soldering Heat 耐焊接熱特性 (Please refer page 9 for soldering conditions) (焊接條件請查閱第 12 頁)	After reflow soldering and restored at room temperature, they meet the characteristics listed below. 經過回流焊並冷卻至室溫後，電容器的特性符合下表的要求。 <table border="1"> <tr> <td>Capacitance Change 靜電容量變化率</td> <td>Within ±10% of initial value 初始值的±10%以內 (*3)</td> </tr> <tr> <td>Dissipation Factor 損耗角正切</td> <td>130% or less of initial specified value 不大於規範值的 130%</td> </tr> <tr> <td>ESR 阻抗值 (*2)</td> <td>130% or less of initial specified value 不大於規範值的 130%</td> </tr> <tr> <td>Leakage Current 漏電流</td> <td>Initial specified value or less 不大於規範值</td> </tr> </table>	Capacitance Change 靜電容量變化率	Within ±10% of initial value 初始值的±10%以內 (*3)	Dissipation Factor 損耗角正切	130% or less of initial specified value 不大於規範值的 130%	ESR 阻抗值 (*2)	130% or less of initial specified value 不大於規範值的 130%	Leakage Current 漏電流	Initial specified value or less 不大於規範值
Capacitance Change 靜電容量變化率	Within ±10% of initial value 初始值的±10%以內 (*3)								
Dissipation Factor 損耗角正切	130% or less of initial specified value 不大於規範值的 130%								
ESR 阻抗值 (*2)	130% or less of initial specified value 不大於規範值的 130%								
Leakage Current 漏電流	Initial specified value or less 不大於規範值								
Marking 標識	Red print on the case top. 鋁殼頂部紅色字體印刷。								

- (*1) If any doubt arises, measure the leakage current after the voltage treatment of applying DC rated voltage continuously to the capacitor for 120 minutes at 105°C.
如未能確定，在 105°C 環境下連續施加額定工作電壓 120 分鐘後測量漏電流。
- (*2) Should be measured at both of the terminal ends closest to the capacitor body.
測試應為靠近兩個端子的末端。
- (*3) The value before test of examination of resistance to soldering.
焊接測試前的值。

□ DRAWING 外形圖 (Unit: mm)

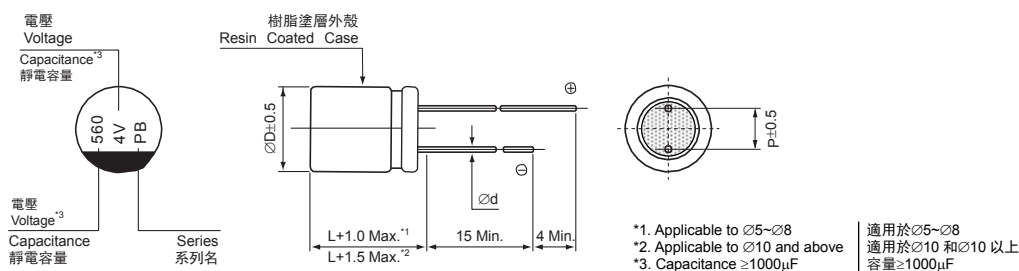

Dimension table in next page.
尺寸表見下一頁。

Note: All design and specifications are for reference only and is subject to change without prior notice. If any doubt about safety for your application, please contact us immediately for technical assistance before purchase.

注: 以上所提供的設計及特性參數僅供參考，任何修改不作預先通知。如果在使用上有疑問，請在採購前與我們聯繫，以便提供技術上的協助。

CAT.2023/V2

PB Series

□ DIMENSIONS 尺寸表 (Unit: mm)

∅D × L	5 × 8/9	5 × 10/12	5.5 × 9/10	6.3 × 7/8/9	6.3 × 11/12/14	8 × 8/9	8 × 11/12	10 × 12/16
P	2.0	2.0	2.0	2.5	2.5	3.5	3.5	5.0
∅d	0.5	0.5	0.5	0.6	0.6	0.6	0.6	0.6
L	8.0/9.0	10.0/12.0	9.0/10	7.0/8.0/9.0	11.0/12.0/14.0	8.0/9.0	11.0/12.0	12.0/16.0

□ DIMENSIONS & STANDARD RATINGS 規格尺寸及標準參數

WV (V)		2.5 (0E)					4 (0G)				
Cap. 容量 (μF)	Parameter 參數	Case size ∅D×L (mm) 尺寸	Dissipation factor (tan δ) 損耗角正切	Leakage current (μA) 漏電流	ESR (mΩ) max. 20°C, 100KHz 阻抗值	Ripple current (mA rms) 105°C, 100KHz 紋波電流	Case size ∅D×L (mm) 尺寸	Dissipation factor (tan δ) 損耗角正切	Leakage current (μA) 漏電流	ESR (mΩ) max. 20°C, 100KHz 阻抗值	Ripple current (mA rms) 105°C, 100KHz 紋波電流
680	681						6.3 × 8	0.08	544	9	5900
820	821	6.3 × 8 (8 × 8)	0.08 (0.08)	410 (410)	7 (7)	5900 (5900)	6.3 × 11	0.08	656	7	6150
1000	102	6.3 × 8	0.08	500	7	5900					
1200	122						6.3 × 11	0.08	960	7	6150
1500	152	8 × 8	0.08	750	7	6100					

WV (V)		6.3 (0J)					10 (1A)				
Cap. 容量 (μF)	Parameter 參數	Case size ∅D×L (mm) 尺寸	Dissipation factor (tan δ) 損耗角正切	Leakage current (μA) 漏電流	ESR (mΩ) max. 20°C, 100KHz 阻抗值	Ripple current (mA rms) 105°C, 100KHz 紋波電流	Case size ∅D×L (mm) 尺寸	Dissipation factor (tan δ) 損耗角正切	Leakage current (μA) 漏電流	ESR (mΩ) max. 20°C, 100KHz 阻抗值	Ripple current (mA rms) 105°C, 100KHz 紋波電流
330	331	5 × 8 (6.3 × 5)	0.08 (0.08)	415 (415)	10 (9)	3200 (4800)	6.3 × 8 (8 × 8)	0.08 (0.08)	660 (660)	12 (12)	4500 (4620)
		5 × 8 (6.3 × 6)	0.08 (0.08)	415 (415)	10 (9)	3200 (4800)					
		5 × 8 (6.3 × 8)	0.08 (0.08)	415 (415)	10 (9)	3200 (5000)					
390	391	5 × 8 (6.3 × 8) (8 × 8)	0.08 (0.08)	491 (491)	12 (12)	3100 (3300)					
470	471	5 × 9 (6.3 × 8) (8 × 8)	0.08 (0.08)	592 (592)	12 (9)	3600 (5900)	6.3 × 8 (8 × 8)	0.08 (0.08)	940 (940)	9 (10)	5400 (5600)
560	561	5 × 9 (6.3 × 8) (8 × 8)	0.08 (0.08)	705 (705)	12 (8)	3600 (5900)	8 × 8	0.08	1120	9	5600
680	681	5 × 12 (6.3 × 8)	0.08 (0.08)	857 (857)	15 (9)	5500 (5900)	6.3 × 11 (8 × 8) (8 × 11)	0.08 (0.08)	1360 (1360)	13 (9)	3650 (5600) (6100)
820	821	6.3 × 9 (6.3 × 11) (8 × 8) (8 × 11)	0.08 (0.08)	1033 (1033)	9 (7) (9)	5900 (6150) (5900) (6150)	8 × 11	0.08	1640	9	6100
1000	102	6.3 × 11 (8 × 8) (8 × 11)	0.08 (0.08)	1260 (1260)	12 (10) (9)	6150 (6000) (6150)	8 × 11	0.08	2000	9	6200
1200	122	6.3 × 12 (8 × 12)	0.08 (0.08)	1512 (1512)	9 (9)	6100 (6150)					
1500	152	6.3 × 14 (8 × 12) (10 × 12)	0.08 (0.08)	1890 (1890)	10 (9) (9)	5400 (6150) (6200)	8 × 12 (10 × 12)	0.08 (0.08)	3000 (3000)	10 (9)	5700 (6100)
2200	222	10 × 12	0.08	2772	9	6200	10 × 12	0.08	4400	9	6500

WV (V)		7.5 (0T)					12 (1R)				
Cap. 容量 (μF)	Parameter 參數	Case size ∅D×L (mm) 尺寸	Dissipation factor (tan δ) 損耗角正切	Leakage current (μA) 漏電流	ESR (mΩ) max. 20°C, 100KHz 阻抗值	Ripple current (mA rms) 105°C, 100KHz 紋波電流	Case size ∅D×L (mm) 尺寸	Dissipation factor (tan δ) 損耗角正切	Leakage current (μA) 漏電流	ESR (mΩ) max. 20°C, 100KHz 阻抗值	Ripple current (mA rms) 105°C, 100KHz 紋波電流
500	501	5 × 9 (6.3 × 9)	0.08 (0.08)	750 (750)	11 (9)	3800 (5900)					
560	561	5 × 9 (6.3 × 9)	0.08 (0.08)	840 (840)	11 (9)	4000 (5900)					
680	681	6.3 × 9 (6.3 × 11)	0.08 (0.08)	1020 (1020)	9 (9)	5900 (5900)					
820	821	6.3 × 9	0.08	1230	9	5900					

Note: All design and specifications are for reference only and is subject to change without prior notice. If any doubt about safety for your application, please contact us immediately for technical assistance before purchase.

注：以上所提供的設計及特性參數僅供參考，任何修改不作預先通知。如果在使用上有疑問，請在採購前與我們聯繫，以便提供技術上的協助。

CAT.2023/V2

PB Series

□ DIMENSIONS & STANDARD RATINGS 規格尺寸及標準參數

WV (V)		16 (1C)				
Cap. 容量 (μF)	Parameter 參數	Case size ØD×L (mm) 尺寸	Dissipation factor (tan δ) 損耗角正切	Leakage current (μA) 漏電流	ESR (mΩ) max. 20°C, 100KHz 阻抗值	Ripple current (mA rms) 105°C, 100KHz 紋波電流
100	101	6.3 × 7	0.08	320	16	3250
220	221	6.3 × 8	0.08	704	14	4100
270	271	6.3 × 8	0.08	864	10	4100
		(8 × 8) (8 × 11)	(0.08) (0.08)	(864) (864)	(10) (10)	(5000) (5000)
330	331	6.3 × 9	0.08	1056	12	4500
		(6.3 × 11)	(0.08)	(1056)	(12)	(4300)
		(8 × 8) (10 × 12)	(0.08) (0.08)	(1056) (1056)	(10) (9)	(5000) (6100)
390	391	8 × 8	0.08	1248	10	5000
470	471	6.3 × 11	0.08	1504	12	4100
		(6.3 × 12)	(0.08)	(1504)	(10)	(5200)
		(8 × 8)	(0.08)	(1504)	(13)	(5000)
		(8 × 11) (10 × 12)	(0.08) (0.08)	(1504) (1504)	(10) (9)	(5400) (5800)
560	561	6.3 × 12	0.08	1792	12	5200
		(8 × 9)	(0.08)	(1792)	(12)	(5200)
		(8 × 11)	(0.08)	(1792)	(10)	(5400)
680	681	8 × 11	0.08	2176	10	5400
		(10 × 12)	(0.08)	(2176)	(10)	(5500)
820	821	8 × 12	0.08	2624	10	5700
		(10 × 12)	(0.08)	(2624)	(10)	(5800)
1000	102	8 × 12	0.08	3200	10	6000
		(10 × 12)	(0.08)	(3200)	(9)	(6500)
1200	122	10 × 12	0.08	3840	9	6500
1500	152	10 × 12	0.08	4800	9	6500
		(10 × 16)	(0.08)	(4800)	(9)	(6500)
2200	222	10 × 16	0.08	7040	10	6500

- Please refer to page 21 about the taped or cutting product spec. 編帶與剪腳標準請查閱第 21 頁。
- Please refer to page 18 for the minimum package quantity. 最小包裝數量請查閱第 18 頁。
- Please refer to page 14 for the Part Number System. 產品編碼規則請查閱第 14 頁。

Note: All design and specifications are for reference only and is subject to change without prior notice. If any doubt about safety for your application, please contact us immediately for technical assistance before purchase.

注：以上所提供的設計及特性參數僅供參考，任何修改不作預先通知。如果在使用上有疑問，請在採購前與我們聯繫，以便提供技術上的協助。

CAT.2023/V2

PR Series

RADIAL LEAD TYPE, HIGH RELIABILITY

插件式，高可靠品

- Operating with wide temperature range -55~+125°C
適用於 -55~+125°C 的寬溫範圍
- High reliability, low ESR, high ripple current
高可靠，低阻抗，高紋波電流
- Endurance 3000 hours
耐久性 3000 小時
- RoHS & REACH compliant, Halogen-free
符合 RoHS 與 REACH，無鹵

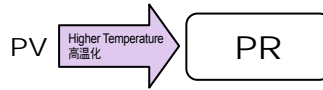
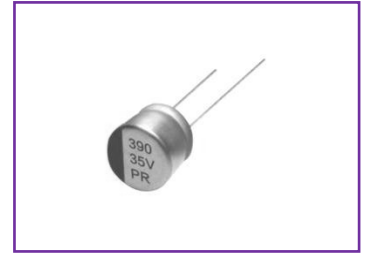

□ SPECIFICATIONS 特性表

Items 項目	Characteristics 主要特性								
Category Temperature Range 工作溫度範圍	-55 ~ +125°C								
Voltage Range 額定工作電壓範圍	6.3 ~ 50V								
Capacitance Range 靜電容量範圍	22 ~ 2200µF								
Capacitance Tolerance 靜電容量允許偏差	±20% at 120Hz, 20°C								
Leakage Current 漏電流 (*1)	≤Specified value (after 2 minutes application of rated voltage at 20°C). ≤規範值 (在 20°C 環境中施加額定工作電壓 2 分鐘後)。								
Dissipation Factor (tan δ) 損耗角正切	≤Specified value at 120Hz, 20°C. ≤規範值 (在 20°C 120Hz 環境下)。								
ESR 阻抗值 (*2)	≤Specified value at 100KHz, 20°C. ≤規範值 (在 20°C 100KHz 環境下)。								
Stability at Low Temperature 低溫特性	Measurement frequency 測試頻率: 100KHz <table border="1"> <tr> <td>Impedance Ratio 阻抗比 Z1/Z20 (max.)</td> <td>Z(+125°C)/Z(20°C)</td> <td>≤1.25</td> </tr> <tr> <td></td> <td>Z(-55°C)/Z(20°C)</td> <td>≤1.25</td> </tr> </table>	Impedance Ratio 阻抗比 Z1/Z20 (max.)	Z(+125°C)/Z(20°C)	≤1.25		Z(-55°C)/Z(20°C)	≤1.25		
Impedance Ratio 阻抗比 Z1/Z20 (max.)	Z(+125°C)/Z(20°C)	≤1.25							
	Z(-55°C)/Z(20°C)	≤1.25							
Damp Heat (Steady State) 穩態濕熱	When the capacitors are restored to 20°C after the rated voltage is applied for 1000 hours at 60°C, 90% RH, they meet the characteristics listed below. 在 60°C 和相對濕度 90% 環境下施加額定工作電壓 1000 小時並冷卻至 20°C 後，電容器的特性符合下表的要求。 <table border="1"> <tr> <td>Capacitance Change 靜電容量變化率</td> <td>Within ±20% of initial value 為初始值的±20%以內 (*3)</td> </tr> <tr> <td>Dissipation Factor 損耗角正切</td> <td>150% or less of initial specified value 不大於規範值的 150%</td> </tr> <tr> <td>ESR 阻抗值 (*2)</td> <td>150% or less of initial specified value 不大於規範值的 150%</td> </tr> <tr> <td>Leakage Current 漏電流</td> <td>Initial specified value or less 不大於規範值</td> </tr> </table>	Capacitance Change 靜電容量變化率	Within ±20% of initial value 為初始值的±20%以內 (*3)	Dissipation Factor 損耗角正切	150% or less of initial specified value 不大於規範值的 150%	ESR 阻抗值 (*2)	150% or less of initial specified value 不大於規範值的 150%	Leakage Current 漏電流	Initial specified value or less 不大於規範值
Capacitance Change 靜電容量變化率	Within ±20% of initial value 為初始值的±20%以內 (*3)								
Dissipation Factor 損耗角正切	150% or less of initial specified value 不大於規範值的 150%								
ESR 阻抗值 (*2)	150% or less of initial specified value 不大於規範值的 150%								
Leakage Current 漏電流	Initial specified value or less 不大於規範值								
Endurance 耐久性	After 3000 hours application of the rated voltage at 125°C, they meet the characteristics listed below. 在 125°C 環境中施加額定工作電壓 3000 小時後，電容器的特性符合下表的要求。 <table border="1"> <tr> <td>Capacitance Change 靜電容量變化率</td> <td>Within ±20% of initial value 為初始值的±20%以內 (*3)</td> </tr> <tr> <td>Dissipation Factor 損耗角正切</td> <td>150% or less of initial specified value 不大於規範值的 150%</td> </tr> <tr> <td>ESR 阻抗值 (*2)</td> <td>150% or less of initial specified value 不大於規範值的 150%</td> </tr> <tr> <td>Leakage Current 漏電流</td> <td>Initial specified value or less 不大於規範值</td> </tr> </table>	Capacitance Change 靜電容量變化率	Within ±20% of initial value 為初始值的±20%以內 (*3)	Dissipation Factor 損耗角正切	150% or less of initial specified value 不大於規範值的 150%	ESR 阻抗值 (*2)	150% or less of initial specified value 不大於規範值的 150%	Leakage Current 漏電流	Initial specified value or less 不大於規範值
Capacitance Change 靜電容量變化率	Within ±20% of initial value 為初始值的±20%以內 (*3)								
Dissipation Factor 損耗角正切	150% or less of initial specified value 不大於規範值的 150%								
ESR 阻抗值 (*2)	150% or less of initial specified value 不大於規範值的 150%								
Leakage Current 漏電流	Initial specified value or less 不大於規範值								
Resistance to Soldering Heat 耐焊接熱特性 (Please refer page 9 for soldering conditions) (焊接條件請查閱第 12 頁)	After reflow soldering and restored at room temperature, they meet the characteristics listed below. 經過回流焊並冷卻至室溫後，電容器的特性符合下表的要求。 <table border="1"> <tr> <td>Capacitance Change 靜電容量變化率</td> <td>Within ±10% of initial value 初始值的±10%以內 (*3)</td> </tr> <tr> <td>Dissipation Factor 損耗角正切</td> <td>130% or less of initial specified value 不大於規範值的 130%</td> </tr> <tr> <td>ESR 阻抗值 (*2)</td> <td>130% or less of initial specified value 不大於規範值的 130%</td> </tr> <tr> <td>Leakage Current 漏電流</td> <td>Initial specified value or less 不大於規範值</td> </tr> </table>	Capacitance Change 靜電容量變化率	Within ±10% of initial value 初始值的±10%以內 (*3)	Dissipation Factor 損耗角正切	130% or less of initial specified value 不大於規範值的 130%	ESR 阻抗值 (*2)	130% or less of initial specified value 不大於規範值的 130%	Leakage Current 漏電流	Initial specified value or less 不大於規範值
Capacitance Change 靜電容量變化率	Within ±10% of initial value 初始值的±10%以內 (*3)								
Dissipation Factor 損耗角正切	130% or less of initial specified value 不大於規範值的 130%								
ESR 阻抗值 (*2)	130% or less of initial specified value 不大於規範值的 130%								
Leakage Current 漏電流	Initial specified value or less 不大於規範值								
Marking 標識	Red print on the case top. 鋁殼頂部紅色字體印刷。								

(*1) If any doubt arises, measure the leakage current after the voltage treatment of applying DC rated voltage continuously to the capacitor for 120 minutes at 105°C. 如未能確定，在 105°C 環境下連續施加額定工作電壓 120 分鐘後測量漏電流。
 (*2) Should be measured at both of the terminal ends closest to the capacitor body. 測試應為靠近兩個端子的末端。
 (*3) The value before test of examination of resistance to soldering. 焊接測試前的值。

□ DRAWING 外形圖 (Unit: mm)

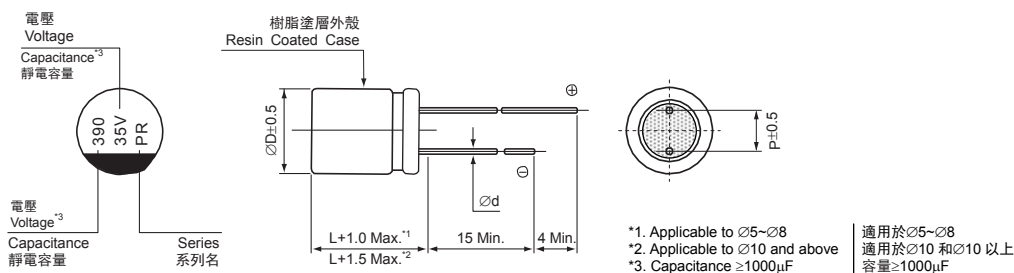

Dimension table in next page.
尺寸表見下一頁。

Note: All design and specifications are for reference only and is subject to change without prior notice. If any doubt about safety for your application, please contact us immediately for technical assistance before purchase.

注: 以上所提供的設計及特性參數僅供參考，任何修改不作預先通知。如果在使用上有疑問，請在採購前與我們聯繫，以便提供技術上的協助。

PR Series

□ DIMENSIONS 尺寸表 (Unit: mm)

∅D × L	5 × 8	8 × 8	8 × 9	8 × 11/12/16	10 × 12/13/16	10 × 21
P	2.0	3.5	3.5	3.5	5.0	5.0
∅d	0.5	0.6	0.6	0.6	0.6	0.6
L	8.0	9.0	9.0	11.0/12.0/16.0	12.0/13.0/16.0	21.0

□ DIMENSIONS & STANDARD RATINGS 規格尺寸及標準參數

WV (V)		6.3 (0J)						16 (1C)					
Cap. 容量 (μF)	Parameter 參數	Case size ∅D×L (mm) 尺寸	Dissipation factor (tan δ) 損耗角正切	Leakage current (μA) 漏電流	ESR (mΩ) max. 20°C, 100KHz 阻抗值	Ripple current (mA rms) 紋波電流		Case size ∅D×L (mm) 尺寸	Dissipation factor (tan δ) 損耗角正切	Leakage current (μA) 漏電流	ESR (mΩ) max. 20°C, 100KHz 阻抗值	Ripple current (mA rms) 紋波電流	
						≤105°C ⁽³⁾	105°C≤125°C ⁽³⁾					≤105°C ⁽³⁾	105°C≤125°C ⁽³⁾
						100	101					5 × 8	0.12
150	151							8 × 9	0.12	480	26	2100	810
220	221	5 × 8	0.12	277	20	2050	950	8 × 12	0.12	704	25	2400	930
330	331	5 × 8	0.12	415	14	2300	880	8 × 8	0.12	1056	13	4700	1570
390	391							10 × 13	0.12	1248	23	2900	1130
1000	102							10 × 13	0.12	3200	12	4500	1730
1500	152	8 × 12	0.12	1890	12	4000	1535						
2200	222	10 × 12	0.12	2772	10	5600	2150						

WV (V)		20 (1D)						25 (1E)					
Cap. 容量 (μF)	Parameter 參數	Case size ∅D×L (mm) 尺寸	Dissipation factor (tan δ) 損耗角正切	Leakage current (μA) 漏電流	ESR (mΩ) max. 20°C, 100KHz 阻抗值	Ripple current (mA rms) 紋波電流		Case size ∅D×L (mm) 尺寸	Dissipation factor (tan δ) 損耗角正切	Leakage current (μA) 漏電流	ESR (mΩ) max. 20°C, 100KHz 阻抗值	Ripple current (mA rms) 紋波電流	
						≤105°C ⁽³⁾	105°C≤125°C ⁽³⁾					≤105°C ⁽³⁾	105°C≤125°C ⁽³⁾
						47	470						
82	820							8 × 9	0.12	410	28	2000	780
120	121	8 × 9	0.12	480	27	2000	800	8 × 12	0.12	600	27	2300	890
150	151	8 × 12	0.12	600	26	2300	910						
180	181							10 × 13	0.12	900	25	2800	1080
270	271	10 × 13	0.12	1080	24	2800	1110						
470	471							8 × 12 (10 × 12)	0.12 (0.12)	2350 (2350)	28 (25)	4250 (4300)	1700 (1720)
560	561							8 × 12	0.12	2800	20	4250	1700
680	681							8 × 12	0.12	2350	20	2800	1080
1000	102							8 × 16 (10 × 16)	0.12 (0.12)	5000 (5000)	25 (14)	4500 (5000)	1730 (2000)
1500	152							10 × 16	0.12	7500	14	5000	2000

WV (V)		35 (1V)						50 (1H)					
Cap. 容量 (μF)	Parameter 參數	Case size ∅D×L (mm) 尺寸	Dissipation factor (tan δ) 損耗角正切	Leakage current (μA) 漏電流	ESR (mΩ) max. 20°C, 100KHz 阻抗值	Ripple current (mA rms) 紋波電流		Case size ∅D×L (mm) 尺寸	Dissipation factor (tan δ) 損耗角正切	Leakage current (μA) 漏電流	ESR (mΩ) max. 20°C, 100KHz 阻抗值	Ripple current (mA rms) 紋波電流	
						≤105°C ⁽³⁾	105°C≤125°C ⁽³⁾					≤105°C ⁽³⁾	105°C≤125°C ⁽³⁾
						22	220						
27	270							8 × 12	0.12	270	33	2000	810
39	390	8 × 9	0.12	273	33	1800	720						
47	470							10 × 13	0.12	470	29	2600	1020
56	560	8 × 12	0.12	392	31	2100	830						
100	101	10 × 13	0.12	700	28	2700	1040	8 × 8	0.12	1000	32	2250	900
120	121							8 × 11 (10 × 12)	0.12 (0.12)	1200 (1200)	32 (20)	2250 (4300)	900 (1350)
220	221	8 × 11	0.12	1540	24	3400	2000	10 × 12	0.12	2200	28	2620	1040
470	471	10 × 12	0.12	3290	28	5000	1920	10 × 21	0.12	4700	28	4900	2000

- Please refer to page 21 about the taped or cutting product spec. 編帶與剪腳標準請查閱第 21 頁。
- Please refer to page 18 for the minimum package quantity. 最小包裝數量請查閱第 18 頁。
- Please refer to page 14 for the Part Number System. 產品編碼規則請查閱第 14 頁。

Note: All design and specifications are for reference only and is subject to change without prior notice. If any doubt about safety for your application, please contact us immediately for technical assistance before purchase.

注：以上所提供的設計及特性參數僅供參考，任何修改不作預先通知。如果在使用上有疑問，請在採購前與我們聯繫，以便提供技術上的協助。

CAT.2023/V2

PS Series

RADIAL LEAD TYPE, LONG LIFE

插件式，長壽命品

- Operating with wide temperature range -55~+105°C
適用於 -55~+105°C 的寬溫範圍
- Long life assurance
長壽命
- Endurance 5000 hours
耐久性 5000 小時
- RoHS & REACH compliant, Halogen-free
符合 RoHS 與 REACH，無鹵

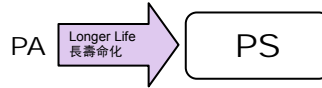
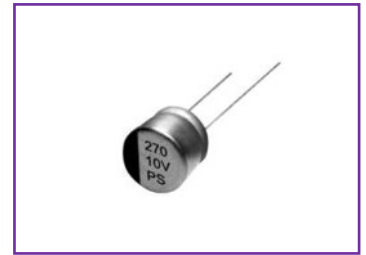

□ SPECIFICATIONS 特性表

Items 項目	Characteristics 主要特性								
Category Temperature Range 工作溫度範圍	-55 ~ +105°C								
Voltage Range 額定工作電壓範圍	2.5 ~ 25V								
Capacitance Range 靜電容量範圍	100 ~ 1500µF								
Capacitance Tolerance 靜電容量允許偏差	±20% at 120Hz, 20°C								
Leakage Current 漏電流 (*1)	≤Specified value (after 2 minutes application of rated voltage at 20°C). ≤規範值(在 20°C 環境中施加額定工作電壓 2 分鐘後)。								
Dissipation Factor (tan δ) 損耗角正切	≤Specified value at 120Hz, 20°C. ≤規範值(在 20°C 120Hz 環境下)。								
ESR 阻抗值 (*2)	≤Specified value at 100KHz, 20°C. ≤規範值(在 20°C 100KHz 環境下)。								
Stability at Low Temperature 低溫特性	Measurement frequency 測試頻率: 100KHz <table border="1"> <tr> <td>Impedance Ratio 阻抗比 ZT/Z20 (max.)</td> <td>Z(+105°C)/Z(20°C)</td> <td>≤1.25</td> </tr> <tr> <td></td> <td>Z(-55°C)/Z(20°C)</td> <td>≤1.25</td> </tr> </table>	Impedance Ratio 阻抗比 ZT/Z20 (max.)	Z(+105°C)/Z(20°C)	≤1.25		Z(-55°C)/Z(20°C)	≤1.25		
Impedance Ratio 阻抗比 ZT/Z20 (max.)	Z(+105°C)/Z(20°C)	≤1.25							
	Z(-55°C)/Z(20°C)	≤1.25							
Damp Heat (Steady State) 穩態濕熱	When the capacitors are restored to 20°C after the rated voltage is applied for 1000 hours at 60°C, 90% RH, they meet the characteristics listed below. 在 60°C 和相對濕度 90%環境下施加額定工作電壓 1000 小時並冷卻至 20°C 後，電容器的特性符合下表的要求。 <table border="1"> <tr> <td>Capacitance Change 靜電容量變化率</td> <td>Within ±20% of initial value 為初始值的±20%以內 (*3)</td> </tr> <tr> <td>Dissipation Factor 損耗角正切</td> <td>150% or less of initial specified value 不大於規範值的 150%</td> </tr> <tr> <td>ESR 阻抗值 (*2)</td> <td>150% or less of initial specified value 不大於規範值的 150%</td> </tr> <tr> <td>Leakage Current 漏電流</td> <td>Initial specified value or less 不大於規範值</td> </tr> </table>	Capacitance Change 靜電容量變化率	Within ±20% of initial value 為初始值的±20%以內 (*3)	Dissipation Factor 損耗角正切	150% or less of initial specified value 不大於規範值的 150%	ESR 阻抗值 (*2)	150% or less of initial specified value 不大於規範值的 150%	Leakage Current 漏電流	Initial specified value or less 不大於規範值
Capacitance Change 靜電容量變化率	Within ±20% of initial value 為初始值的±20%以內 (*3)								
Dissipation Factor 損耗角正切	150% or less of initial specified value 不大於規範值的 150%								
ESR 阻抗值 (*2)	150% or less of initial specified value 不大於規範值的 150%								
Leakage Current 漏電流	Initial specified value or less 不大於規範值								
Endurance 耐久性	After 5000 hours application of the rated voltage at 105°C, they meet the characteristics listed below. 在 105°C 環境中施加額定工作電壓 5000 小時後，電容器的特性符合下表的要求。 <table border="1"> <tr> <td>Capacitance Change 靜電容量變化率</td> <td>Within ±20% of initial value 為初始值的±20%以內 (*3)</td> </tr> <tr> <td>Dissipation Factor 損耗角正切</td> <td>150% or less of initial specified value 不大於規範值的 150%</td> </tr> <tr> <td>ESR 阻抗值 (*2)</td> <td>150% or less of initial specified value 不大於規範值的 150%</td> </tr> <tr> <td>Leakage Current 漏電流</td> <td>Initial specified value or less 不大於規範值</td> </tr> </table>	Capacitance Change 靜電容量變化率	Within ±20% of initial value 為初始值的±20%以內 (*3)	Dissipation Factor 損耗角正切	150% or less of initial specified value 不大於規範值的 150%	ESR 阻抗值 (*2)	150% or less of initial specified value 不大於規範值的 150%	Leakage Current 漏電流	Initial specified value or less 不大於規範值
Capacitance Change 靜電容量變化率	Within ±20% of initial value 為初始值的±20%以內 (*3)								
Dissipation Factor 損耗角正切	150% or less of initial specified value 不大於規範值的 150%								
ESR 阻抗值 (*2)	150% or less of initial specified value 不大於規範值的 150%								
Leakage Current 漏電流	Initial specified value or less 不大於規範值								
Resistance to Soldering Heat 耐焊接熱特性 (Please refer page 9 for soldering conditions) (焊接條件請查閱第 12 頁)	After reflow soldering and restored at room temperature, they meet the characteristics listed below. 經過回流焊並冷卻至室溫後，電容器的特性符合下表的要求。 <table border="1"> <tr> <td>Capacitance Change 靜電容量變化率</td> <td>Within ±10% of initial value 初始值的±10%以內 (*3)</td> </tr> <tr> <td>Dissipation Factor 損耗角正切</td> <td>130% or less of initial specified value 不大於規範值的 130%</td> </tr> <tr> <td>ESR 阻抗值 (*2)</td> <td>130% or less of initial specified value 不大於規範值的 130%</td> </tr> <tr> <td>Leakage Current 漏電流</td> <td>Initial specified value or less 不大於規範值</td> </tr> </table>	Capacitance Change 靜電容量變化率	Within ±10% of initial value 初始值的±10%以內 (*3)	Dissipation Factor 損耗角正切	130% or less of initial specified value 不大於規範值的 130%	ESR 阻抗值 (*2)	130% or less of initial specified value 不大於規範值的 130%	Leakage Current 漏電流	Initial specified value or less 不大於規範值
Capacitance Change 靜電容量變化率	Within ±10% of initial value 初始值的±10%以內 (*3)								
Dissipation Factor 損耗角正切	130% or less of initial specified value 不大於規範值的 130%								
ESR 阻抗值 (*2)	130% or less of initial specified value 不大於規範值的 130%								
Leakage Current 漏電流	Initial specified value or less 不大於規範值								
Marking 標識	Red print on the case top. 鋁殼頂部紅色字體印刷。								

(*1) If any doubt arises, measure the leakage current after the voltage treatment of applying DC rated voltage continuously to the capacitor for 120 minutes at 105°C.

如未能確定，在 105°C 環境下連續施加額定工作電壓 120 分鐘後測量漏電流。

(*2) Should be measured at both of the terminal ends closest to the capacitor body.

測試應為靠近兩個端子的末端。

(*3) The value before test of examination of resistance to soldering.

焊接測試前的值。

□ DRAWING 外形圖 (Unit: mm)

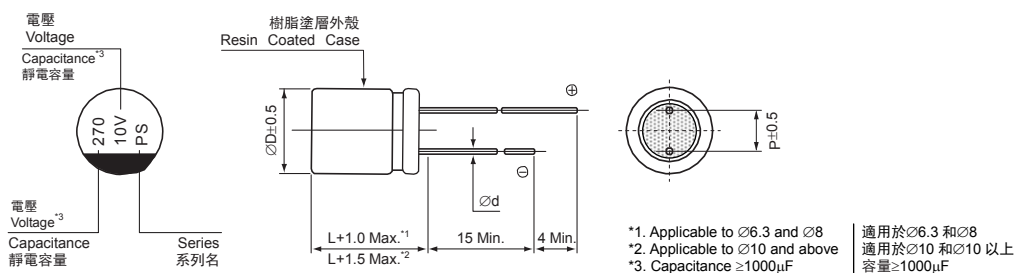

Dimension table in next page.
尺寸表見下一頁。

Note: All design and specifications are for reference only and is subject to change without prior notice. If any doubt about safety for your application, please contact us immediately for technical assistance before purchase.

注: 以上所提供的設計及特性參數僅供參考，任何修改不作預先通知。如果在使用上有疑問，請在採購前與我們聯繫，以便提供技術上的協助。

CAT.2023/V2

PS Series

□ DIMENSIONS 尺寸表 (Unit: mm)

ØD × L	6.3 × 6/6.5/9	6.3 × 10.5	8 × 7	8 × 9	8 × 11/12	10 × 13/21
P	2.5	2.5	3.5	3.5	3.5	5.0
Ød	0.6	0.6	0.6	0.6	0.6	0.6
L	6.0/6.5/9.0	10.5	7.0	9.0	11.0/12.0	13.0/21.0

□ DIMENSIONS & STANDARD RATINGS 規格尺寸及標準參數

WV (V)		2.5 (0E)					4 (0G)				
Cap. 容量 (µF)	Parameter 參數	Case size ØD×L (mm) 尺寸	Dissipation factor (tan δ) 損耗角正切	Leakage current (µA) 漏電流	ESR (mΩ) max. 20°C, 100KHz 阻抗值	Ripple current (mA rms) 105°C, 100KHz 紋波電流	Case size ØD×L (mm) 尺寸	Dissipation factor (tan δ) 損耗角正切	Leakage current (µA) 漏電流	ESR (mΩ) max. 20°C, 100KHz 阻抗值	Ripple current (mA rms) 105°C, 100KHz 紋波電流
330	331	6.3 × 9	0.08	165	8	4800					
560	561	6.3 × 6.5	0.08	280	10	3900	8 × 7 (8 × 9)	0.08 (0.08)	448 (448)	15 (7)	3900 (5200)
680	681	8 × 7	0.08	340	15	3900	8 × 12	0.08	544	7	5800
820	821	6.3 × 9 (8 × 9) (8 × 12)	0.08 (0.08) (0.08)	410 (410) (410)	8 (7) (7)	4800 (5200) (5800)					
1200	122						10 × 13	0.08	960	8	5500
1500	152	10 × 13	0.08	750	8	5500					

WV (V)		6.3 (0J)					10 (1A)				
Cap. 容量 (µF)	Parameter 參數	Case size ØD×L (mm) 尺寸	Dissipation factor (tan δ) 損耗角正切	Leakage current (µA) 漏電流	ESR (mΩ) max. 20°C, 100KHz 阻抗值	Ripple current (mA rms) 105°C, 100KHz 紋波電流	Case size ØD×L (mm) 尺寸	Dissipation factor (tan δ) 損耗角正切	Leakage current (µA) 漏電流	ESR (mΩ) max. 20°C, 100KHz 阻抗值	Ripple current (mA rms) 105°C, 100KHz 紋波電流
150	151						6.3 × 10.5	0.08	300	20	3000
270	271						8 × 12	0.08	540	8	4900
330	331	6.3 × 10.5	0.08	416	20	3000					
390	391	8 × 7	0.08	491	15	3900					
470	471	8 × 12	0.08	592	7	5500	10 × 13	0.08	940	8	5500
560	561	6.3 × 9 (8 × 9)	0.08 (0.08)	706 (706)	9 (8)	4300 (5000)					
820	821	10 × 13	0.08	1033	8	5500					

WV (V)		16 (1C)					25 (1E)				
Cap. 容量 (µF)	Parameter 參數	Case size ØD×L (mm) 尺寸	Dissipation factor (tan δ) 損耗角正切	Leakage current (µA) 漏電流	ESR (mΩ) max. 20°C, 100KHz 阻抗值	Ripple current (mA rms) 105°C, 100KHz 紋波電流	Case size ØD×L (mm) 尺寸	Dissipation factor (tan δ) 損耗角正切	Leakage current (µA) 漏電流	ESR (mΩ) max. 20°C, 100KHz 阻抗值	Ripple current (mA rms) 105°C, 100KHz 紋波電流
270	271	8 × 12	0.08	864	9	4500					
330	331	10 × 13	0.08	1056	9	4700	8 × 11	0.08	1650	18	4500
470	471	10 × 13	0.08	1504	9	4700	8 × 12	0.08	2350	16	5000
1000	102						10 × 21	0.08	7000	22	3300

- Please refer to page 21 about the taped or cutting product spec. 編帶與剪腳標準請查閱第 21 頁。
- Please refer to page 18 for the minimum package quantity. 最小包裝數量請查閱第 18 頁。
- Please refer to page 14 for the Part Number System. 產品編碼規則請查閱第 14 頁。

Note: All design and specifications are for reference only and is subject to change without prior notice. If any doubt about safety for your application, please contact us immediately for technical assistance before purchase.

注：以上所提供的設計及特性參數僅供參考，任何修改不作預先通知。如果在使用上有疑問，請在採購前與我們聯繫，以便提供技術上的協助。

CAT.2023/V2

PX Series

RADIAL LEAD TYPE, ULTRA LONG LIFE

插件式，超長壽命品

- Operating with wide temperature range -55~+105°C
適用於 -55~+105°C 的寬溫範圍
- Ultra-low ESR, High Ripple Current
超低阻抗，高紋波電流
- Endurance 20000 hours
耐久性 20000 小時
- RoHS & REACH compliant, Halogen-free
符合 RoHS 與 REACH，無鹵

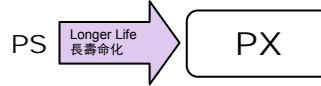

□ SPECIFICATIONS 特性表

Items 項目	Characteristics 主要特性								
Category Temperature Range 工作溫度範圍	-55 ~ +105°C								
Voltage Range 額定工作電壓範圍	4 ~ 16V								
Capacitance Range 靜電容量範圍	100 ~ 1200µF								
Capacitance Tolerance 靜電容量允許偏差	±20% at 120Hz, 20°C								
Leakage Current 漏電流 (*1)	≤Specified value (after 2 minutes application of rated voltage at 20°C). ≤規範值(在 20°C 環境中施加額定工作電壓 2 分鐘後)。								
Dissipation Factor (tan δ) 損耗角正切	≤Specified value at 120Hz, 20°C. ≤規範值(在 20°C 120Hz 環境下)。								
ESR 阻抗值 (*2)	≤Specified value at 100KHz, 20°C. ≤規範值(在 20°C 100KHz 環境下)。								
Stability at Low Temperature 低溫特性	Measurement frequency 測試頻率: 100KHz <table border="1"> <tr> <td>Impedance Ratio 阻抗比 ZT/Z20 (max.)</td> <td>Z(+105°C)/Z(20°C) Z(-55°C)/Z(20°C)</td> <td>≤1.25 ≤1.25</td> </tr> </table>	Impedance Ratio 阻抗比 ZT/Z20 (max.)	Z(+105°C)/Z(20°C) Z(-55°C)/Z(20°C)	≤1.25 ≤1.25					
Impedance Ratio 阻抗比 ZT/Z20 (max.)	Z(+105°C)/Z(20°C) Z(-55°C)/Z(20°C)	≤1.25 ≤1.25							
Damp Heat (Steady State) 穩態濕熱	When the capacitors are restored to 20°C after the rated voltage is applied for 1000 hours at 60°C, 90% RH, they meet the characteristics listed below. 在 60°C 和相對濕度 90% 環境下施加額定工作電壓 1000 小時並冷卻至 20°C 後，電容器的特性符合下表的要求。 <table border="1"> <tr> <td>Capacitance Change 靜電容量變化率</td> <td>Within ±20% of initial value 為初始值的±20%以內 (*3)</td> </tr> <tr> <td>Dissipation Factor 損耗角正切</td> <td>150% or less of initial specified value 不大於規範值的 150%</td> </tr> <tr> <td>ESR 阻抗值 (*2)</td> <td>150% or less of initial specified value 不大於規範值的 150%</td> </tr> <tr> <td>Leakage Current 漏電流</td> <td>Initial specified value or less 不大於規範值</td> </tr> </table>	Capacitance Change 靜電容量變化率	Within ±20% of initial value 為初始值的±20%以內 (*3)	Dissipation Factor 損耗角正切	150% or less of initial specified value 不大於規範值的 150%	ESR 阻抗值 (*2)	150% or less of initial specified value 不大於規範值的 150%	Leakage Current 漏電流	Initial specified value or less 不大於規範值
Capacitance Change 靜電容量變化率	Within ±20% of initial value 為初始值的±20%以內 (*3)								
Dissipation Factor 損耗角正切	150% or less of initial specified value 不大於規範值的 150%								
ESR 阻抗值 (*2)	150% or less of initial specified value 不大於規範值的 150%								
Leakage Current 漏電流	Initial specified value or less 不大於規範值								
Endurance 耐久性	After 20000 hours application of the rated voltage at 105°C, they meet the characteristics listed below. 在 105°C 環境中施加額定工作電壓 20000 小時後，電容器的特性符合下表的要求。 <table border="1"> <tr> <td>Capacitance Change 靜電容量變化率</td> <td>Within ±20% of initial value 為初始值的±20%以內 (*3)</td> </tr> <tr> <td>Dissipation Factor 損耗角正切</td> <td>150% or less of initial specified value 不大於規範值的 150%</td> </tr> <tr> <td>ESR 阻抗值 (*2)</td> <td>150% or less of initial specified value 不大於規範值的 150%</td> </tr> <tr> <td>Leakage Current 漏電流</td> <td>Initial specified value or less 不大於規範值</td> </tr> </table>	Capacitance Change 靜電容量變化率	Within ±20% of initial value 為初始值的±20%以內 (*3)	Dissipation Factor 損耗角正切	150% or less of initial specified value 不大於規範值的 150%	ESR 阻抗值 (*2)	150% or less of initial specified value 不大於規範值的 150%	Leakage Current 漏電流	Initial specified value or less 不大於規範值
Capacitance Change 靜電容量變化率	Within ±20% of initial value 為初始值的±20%以內 (*3)								
Dissipation Factor 損耗角正切	150% or less of initial specified value 不大於規範值的 150%								
ESR 阻抗值 (*2)	150% or less of initial specified value 不大於規範值的 150%								
Leakage Current 漏電流	Initial specified value or less 不大於規範值								
Resistance to Soldering Heat 耐焊接熱特性 (Please refer page 9 for soldering conditions) (焊接條件請查閱第 12 頁)	After reflow soldering and restored at room temperature, they meet the characteristics listed below. 經過回流焊並冷卻至室溫後，電容器的特性符合下表的要求。 <table border="1"> <tr> <td>Capacitance Change 靜電容量變化率</td> <td>Within ±10% of initial value 初始值的±10%以內 (*3)</td> </tr> <tr> <td>Dissipation Factor 損耗角正切</td> <td>130% or less of initial specified value 不大於規範值的 130%</td> </tr> <tr> <td>ESR 阻抗值 (*2)</td> <td>130% or less of initial specified value 不大於規範值的 130%</td> </tr> <tr> <td>Leakage Current 漏電流</td> <td>Initial specified value or less 不大於規範值</td> </tr> </table>	Capacitance Change 靜電容量變化率	Within ±10% of initial value 初始值的±10%以內 (*3)	Dissipation Factor 損耗角正切	130% or less of initial specified value 不大於規範值的 130%	ESR 阻抗值 (*2)	130% or less of initial specified value 不大於規範值的 130%	Leakage Current 漏電流	Initial specified value or less 不大於規範值
Capacitance Change 靜電容量變化率	Within ±10% of initial value 初始值的±10%以內 (*3)								
Dissipation Factor 損耗角正切	130% or less of initial specified value 不大於規範值的 130%								
ESR 阻抗值 (*2)	130% or less of initial specified value 不大於規範值的 130%								
Leakage Current 漏電流	Initial specified value or less 不大於規範值								
Marking 標識	Red print on the case top. 鋁殼頂部紅色字體印刷。								

- (*1) If any doubt arises, measure the leakage current after the voltage treatment of applying DC rated voltage continuously to the capacitor for 120 minutes at 105°C.
如未能確定，在 105°C 環境下連續施加額定工作電壓 120 分鐘後測量漏電流。
- (*2) Should be measured at both of the terminal ends closest to the capacitor body.
測試應為靠近兩個端子的末端。
- (*3) The value before test of examination of resistance to soldering.
焊接測試前的值。

□ DRAWING 外形圖 (Unit: mm)

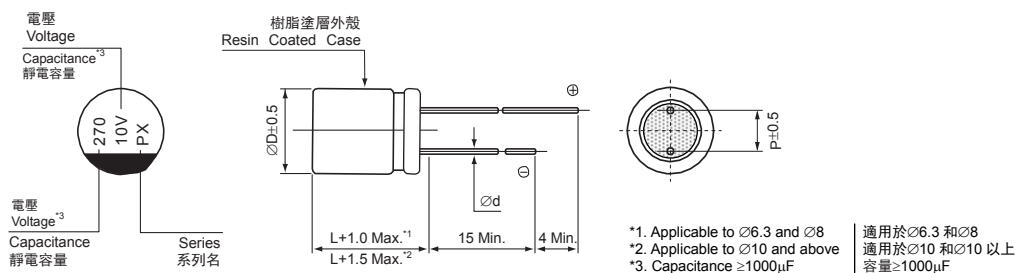

Dimension table in next page.
尺寸表見下一頁。

Note: All design and specifications are for reference only and is subject to change without prior notice. If any doubt about safety for your application, please contact us immediately for technical assistance before purchase.

注: 以上所提供的設計及特性參數僅供參考，任何修改不作預先通知。如果在使用上有疑問，請在採購前與我們聯繫，以便提供技術上的協助。

CAT.2023/V2

PX Series

□ DIMENSIONS 尺寸表 (Unit: mm)

ØD × L	6.3 × 9	6.3 × 10.5	8 × 7	8 × 9	8 × 12	10 × 13
P	2.5	2.5	3.5	3.5	3.5	5.0
Ød	0.6	0.6	0.6	0.6	0.6	0.6
L	9.0	10.5	7.0	9.0	12.0	13.0

□ DIMENSIONS & STANDARD RATINGS 規格尺寸及標準參數

WV (V)		4 (0G)					6.3 (0J)								
Cap. 容量 (µF)	Parameter 參數	Case size ØD×L (mm) 尺寸	Dissipation factor (tan δ) 損耗角正切	Leakage current (µA) 漏電流	ESR (mΩ) max. 20°C, 100KHz 阻抗值	Ripple current (mA rms) 105°C, 100KHz 紋波電流	Case size ØD×L (mm) 尺寸	Dissipation factor (tan δ) 損耗角正切	Leakage current (µA) 漏電流	ESR (mΩ) max. 20°C, 100KHz 阻抗值	Ripple current (mA rms) 105°C, 100KHz 紋波電流				
												270	271	330	331
		6.3 × 9	0.08	216	8	4800									
							6.3 × 10.5	0.08	416	20	3000				
							8 × 7	0.08	491	15	3900				
							8 × 12	0.08	592	7	5500				
		8 × 7 (8 × 9)	0.08 (0.08)	448 (448)	15 (7)	3900 (5200)	6 × 9 (8 × 9)	0.08 (0.08)	706 (706)	9 (8)	4300 (5000)				
		8 × 12	0.08	544	7	5500									
							10 × 13	0.08	1033	8	5500				
		10 × 13	0.08	960	8	5800									

WV (V)		10 (1A)					16 (1C)				
Cap. 容量 (µF)	Parameter 參數	Case size ØD×L (mm) 尺寸	Dissipation factor (tan δ) 損耗角正切	Leakage current (µA) 漏電流	ESR (mΩ) max. 20°C, 100KHz 阻抗值	Ripple current (mA rms) 105°C, 100KHz 紋波電流	Case size ØD×L (mm) 尺寸	Dissipation factor (tan δ) 損耗角正切	Leakage current (µA) 漏電流	ESR (mΩ) max. 20°C, 100KHz 阻抗值	Ripple current (mA rms) 105°C, 100KHz 紋波電流
							6.3 × 10.5	0.08	320	24	2800
		6.3 × 10.5	0.08	300	20	3000					
		8 × 12	0.08	540	8	4900	8 × 12	0.08	864	9	4500
							10 × 13	0.08	1056	9	4700
		10 × 13	0.08	940	8	5500	10 × 13	0.08	1504	9	4700

- Please refer to page 21 about the taped or cutting product spec. 編帶與剪腳標準請查閱第 21 頁。
- Please refer to page 18 for the minimum package quantity. 最小包裝數量請查閱第 18 頁。
- Please refer to page 14 for the Part Number System. 產品編碼規則請查閱第 14 頁。

Note: All design and specifications are for reference only and is subject to change without prior notice. If any doubt about safety for your application, please contact us immediately for technical assistance before purchase.

注：以上所提供的設計及特性參數僅供參考，任何修改不作預先通知。如果在使用上有疑問，請在採購前與我們聯繫，以便提供技術上的協助。

CAT.2023/V2

PV Series

RADIAL LEAD TYPE, HIGH VOLTAGE/LONG LIFE

插件式，高壓長壽命品

- Operating with wide temperature range -55~+105°C
適用於 -55~+105°C 的寬溫範圍
- High voltage, low ESR, high ripple current
高電壓，低阻抗，高紋波電流
- Endurance 3000 hours
耐久性 3000 小時
- RoHS & REACH compliant, Halogen-free
符合 RoHS 與 REACH，無鹵

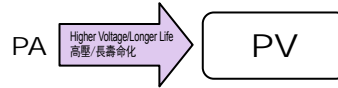

□ SPECIFICATIONS 特性表

Items 項目	Characteristics 主要特性								
Category Temperature Range 工作溫度範圍	-55 ~ +105°C								
Voltage Range 額定工作電壓範圍	16 ~ 100V								
Capacitance Range 靜電容量範圍	6.8 ~ 2700µF								
Capacitance Tolerance 靜電容量允許偏差	±20% at 120Hz, 20°C								
Leakage Current 漏電流 (*1)	≤Specified value (after 2 minutes application of rated voltage at 20°C). ≤規範值(在 20°C 環境中施加額定工作電壓 2 分鐘後)。								
Dissipation Factor (tan δ) 損耗角正切	≤Specified value at 120Hz, 20°C. ≤規範值(在 20°C 120Hz 環境下)。								
ESR 阻抗值 (*2)	≤Specified value at 100KHz, 20°C. ≤規範值(在 20°C 100KHz 環境下)。								
Stability at Low Temperature 低溫特性	Measurement frequency 測試頻率: 100KHz <table border="1"> <tr> <td>Impedance Ratio 阻抗比 ZT/Z20 (max.)</td> <td>Z(+105°C)/Z(20°C) Z(-55°C)/Z(20°C)</td> <td>≤1.25 ≤1.25</td> </tr> </table>	Impedance Ratio 阻抗比 ZT/Z20 (max.)	Z(+105°C)/Z(20°C) Z(-55°C)/Z(20°C)	≤1.25 ≤1.25					
Impedance Ratio 阻抗比 ZT/Z20 (max.)	Z(+105°C)/Z(20°C) Z(-55°C)/Z(20°C)	≤1.25 ≤1.25							
Damp Heat (Steady State) 穩態濕熱	When the capacitors are restored to 20°C after the rated voltage is applied for 1000 hours at 60°C, 90% RH, they meet the characteristics listed below. 在 60°C 和相對濕度 90% 環境下施加額定工作電壓 1000 小時並冷卻至 20°C 後，電容器的特性符合下表的要求。 <table border="1"> <tr> <td>Capacitance Change 靜電容量變化率</td> <td>Within ±20% of initial value 為初始值的±20%以內 (*3)</td> </tr> <tr> <td>Dissipation Factor 損耗角正切</td> <td>150% or less of initial specified value 不大於規範值的 150%</td> </tr> <tr> <td>ESR 阻抗值 (*2)</td> <td>150% or less of initial specified value 不大於規範值的 150%</td> </tr> <tr> <td>Leakage Current 漏電流</td> <td>Initial specified value or less 不大於規範值</td> </tr> </table>	Capacitance Change 靜電容量變化率	Within ±20% of initial value 為初始值的±20%以內 (*3)	Dissipation Factor 損耗角正切	150% or less of initial specified value 不大於規範值的 150%	ESR 阻抗值 (*2)	150% or less of initial specified value 不大於規範值的 150%	Leakage Current 漏電流	Initial specified value or less 不大於規範值
Capacitance Change 靜電容量變化率	Within ±20% of initial value 為初始值的±20%以內 (*3)								
Dissipation Factor 損耗角正切	150% or less of initial specified value 不大於規範值的 150%								
ESR 阻抗值 (*2)	150% or less of initial specified value 不大於規範值的 150%								
Leakage Current 漏電流	Initial specified value or less 不大於規範值								
Endurance 耐久性	After 3000 hours application of the rated voltage at 105°C, they meet the characteristics listed below. 在 105°C 環境中施加額定工作電壓 3000 小時後，電容器的特性符合下表的要求。 <table border="1"> <tr> <td>Capacitance Change 靜電容量變化率</td> <td>Within ±20% of initial value 為初始值的±20%以內 (*3)</td> </tr> <tr> <td>Dissipation Factor 損耗角正切</td> <td>150% or less of initial specified value 不大於規範值的 150%</td> </tr> <tr> <td>ESR 阻抗值 (*2)</td> <td>150% or less of initial specified value 不大於規範值的 150%</td> </tr> <tr> <td>Leakage Current 漏電流</td> <td>Initial specified value or less 不大於規範值</td> </tr> </table>	Capacitance Change 靜電容量變化率	Within ±20% of initial value 為初始值的±20%以內 (*3)	Dissipation Factor 損耗角正切	150% or less of initial specified value 不大於規範值的 150%	ESR 阻抗值 (*2)	150% or less of initial specified value 不大於規範值的 150%	Leakage Current 漏電流	Initial specified value or less 不大於規範值
Capacitance Change 靜電容量變化率	Within ±20% of initial value 為初始值的±20%以內 (*3)								
Dissipation Factor 損耗角正切	150% or less of initial specified value 不大於規範值的 150%								
ESR 阻抗值 (*2)	150% or less of initial specified value 不大於規範值的 150%								
Leakage Current 漏電流	Initial specified value or less 不大於規範值								
Resistance to Soldering Heat 耐焊接熱特性 (Please refer page 9 for soldering conditions) (焊接條件請查閱第 12 頁)	After reflow soldering and restored at room temperature, they meet the characteristics listed below. 經過回流焊並冷卻至室溫後，電容器的特性符合下表的要求。 <table border="1"> <tr> <td>Capacitance Change 靜電容量變化率</td> <td>Within ±10% of initial value 初始值的±10%以內 (*3)</td> </tr> <tr> <td>Dissipation Factor 損耗角正切</td> <td>130% or less of initial specified value 不大於規範值的 130%</td> </tr> <tr> <td>ESR 阻抗值 (*2)</td> <td>130% or less of initial specified value 不大於規範值的 130%</td> </tr> <tr> <td>Leakage Current 漏電流</td> <td>Initial specified value or less 不大於規範值</td> </tr> </table>	Capacitance Change 靜電容量變化率	Within ±10% of initial value 初始值的±10%以內 (*3)	Dissipation Factor 損耗角正切	130% or less of initial specified value 不大於規範值的 130%	ESR 阻抗值 (*2)	130% or less of initial specified value 不大於規範值的 130%	Leakage Current 漏電流	Initial specified value or less 不大於規範值
Capacitance Change 靜電容量變化率	Within ±10% of initial value 初始值的±10%以內 (*3)								
Dissipation Factor 損耗角正切	130% or less of initial specified value 不大於規範值的 130%								
ESR 阻抗值 (*2)	130% or less of initial specified value 不大於規範值的 130%								
Leakage Current 漏電流	Initial specified value or less 不大於規範值								
Marking 標識	Red print on the case top. 鋁殼頂部紅色字體印刷。								

(*1) If any doubt arises, measure the leakage current after the voltage treatment of applying DC rated voltage continuously to the capacitor for 120 minutes at 105°C.

如未能確定，在 105°C 環境下連續施加額定工作電壓 120 分鐘後測量漏電流。

(*2) Should be measured at both of the terminal ends closest to the capacitor body.

測試應為靠近兩個端子的末端。

(*3) The value before test of examination of resistance to soldering.

焊接測試前的值。

□ DRAWING 外形圖 (Unit: mm)

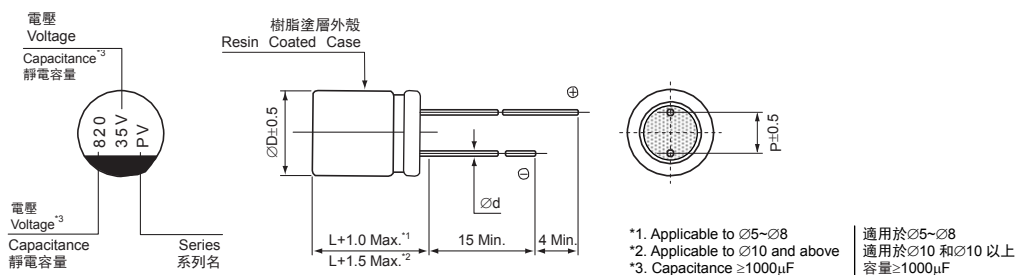

Dimension table in next page.
尺寸表見下一頁。

Note: All design and specifications are for reference only and is subject to change without prior notice. If any doubt about safety for your application, please contact us immediately for technical assistance before purchase.

注: 以上所提供的設計及特性參數僅供參考，任何修改不作預先通知。如果在使用上有疑問，請在採購前與我們聯繫，以便提供技術上的協助。

CAT.2023/V2

PV Series

□ DIMENSIONS 尺寸表 (Unit: mm)

∅D × L	5 × 6/8/11/12	6.3 × 6/8/9	6.3 × 11/12	8 × 8/9	8 × 11/12	10 × 10/12/13	10 × 16/21
P	2.0	2.5	2.5	3.5	3.5	5.0	5.0
∅d	0.5	0.6	0.6	0.6	0.6	0.6	0.6
L	6.0/8.0/11/12	6.0/8.0/9.0	11.0/12.0	8.0/9.0	11.0/12.0	10.0/12.0/13.0	16.0/21.0

□ DIMENSIONS & STANDARD RATINGS 規格尺寸及標準參數

WV (V)		16 (1C)					20 (1D)				
Cap. 容量 (μF)	Parameter 參數	Case size ∅D×L (mm) 尺寸	Dissipation factor (tan δ) 損耗角正切	Leakage current (μA) 漏電流	ESR (mΩ) max. 20°C, 100KHz 阻抗值	Ripple current (mA rms) 105°C, 100KHz 紋波電流	Case size ∅D×L (mm) 尺寸	Dissipation factor (tan δ) 損耗角正切	Leakage current (μA) 漏電流	ESR (mΩ) max. 20°C, 100KHz 阻抗值	Ripple current (mA rms) 105°C, 100KHz 紋波電流
		150	151	8 × 8	0.12	1050	26	2600	8 × 9	0.12	600
220	221	8 × 9	0.12	704	26	2100	8 × 12	0.12	880	25	2400
270	271	8 × 12	0.12	864	24	2500	8 × 12	0.12	1080	25	2400
330	331						10 × 13	0.12	1320	24	2800
470	471	10 × 13	0.12	1504	23	2900					
680	681	10 × 13	0.12	2176	23	2900					
2200	222	10 × 21	0.12	7040	14	4800					

WV (V)		25 (1E)					35 (1V)				
Cap. 容量 (μF)	Parameter 參數	Case size ∅D×L (mm) 尺寸	Dissipation factor (tan δ) 損耗角正切	Leakage current (μA) 漏電流	ESR (mΩ) max. 20°C, 100KHz 阻抗值	Ripple current (mA rms) 105°C, 100KHz 紋波電流	Case size ∅D×L (mm) 尺寸	Dissipation factor (tan δ) 損耗角正切	Leakage current (μA) 漏電流	ESR (mΩ) max. 20°C, 100KHz 阻抗值	Ripple current (mA rms) 105°C, 100KHz 紋波電流
		10	100	5 × 6	0.12	50	70	1500	5 × 8	0.12	70
22	220	5 × 6	0.12	110	60	1500	5 × 8	0.12	154	60	1500
47	470	5 × 8 (6.3 × 6)	0.12 (0.12)	235 (235)	49 (44)	1500 (1850)	5 × 8 (6.3 × 6)	0.12 (0.12)	329 (329)	55 (35)	1700 (1800)
56	560	5 × 8 (6.3 × 6)	0.12 (0.12)	280 (280)	44 (44)	1850 (1850)	8 × 9	0.12	392	29	1900
68	681						5 × 9	0.12	476	48	1800
82	820	6.3 × 8	0.12	410	35	1900	8 × 12	0.12	574	27	2300
100	101	4 × 11 (5 × 8) (6.3 × 8) (8 × 8)	0.12 (0.12) (0.12) (0.12)	500 (500) (500) (500)	85 (35) (23) (23)	950 (2800) (3300) (3500)	6.3 × 8 (8 × 8)	0.12 (0.12)	700 (700)	28 (28)	2500 (2500)
120	121	8 × 9	0.12	600	28	2000	5 × 12 (6.3 × 9)	0.12 (0.12)	840 (840)	40 (40)	2500 (2500)
150	151	6.3 × 9 (8 × 12)	0.12 (0.12)	750 (750)	23 (26)	3300 (2400)	8 × 8 (10 × 13)	0.12 (0.12)	1050 (1050)	26 (26)	2700 (2700)
220	221	6.3 × 8 (6.3 × 8) (8 × 8) (8 × 11)	0.12 (0.12) (0.12) (0.12)	1100 (1100) (1100) (1100)	27 (27) (22) (22)	2300 (2300) (2400) (2600)	6.3 × 12 (8 × 8) (8 × 11) (8 × 12)	0.12 (0.12) (0.12) (0.12)	1540 (1540) (1540) (1540)	16 (16) (16) (16)	2800 (2800) (2800) (2800)
270	271	5 × 11 (6.3 × 12) (10 × 13)	0.12 (0.12) (0.12)	1350 (1350) (1350)	29 (27) (25)	2300 (2300) (2800)	8 × 12	0.12	1890	16	3300
330	331	6.3 × 9 (6.3 × 12) (8 × 11) (10 × 10) (10 × 12)	0.12 (0.12) (0.12) (0.12) (0.12)	1650 (1650) (1650) (1650) (1650)	27 (27) (22) (22) (22)	2300 (2300) (3100) (3100) (3300)	8 × 12 (10 × 12)	0.12 (0.12)	2310 (2310)	20 (20)	3300 (3600)
470	471	6.3 × 12 (8 × 12)	0.12 (0.12)	2350 (2350)	25 (20)	3000 (3300)	8 × 16 (10 × 10) (10 × 12)	0.12 (0.12) (0.12)	3290 (3290) (3290)	20 (20) (20)	3600 (3600) (3600)
560	561	6.3 × 16 (8 × 12)	0.12 (0.12)	2800 (2800)	20 (15)	3100 (3400)	10 × 12	0.12	3920	20	3600
680	681	6.3 × 14 (8 × 12) (8 × 16) (10 × 12)	0.12 (0.12) (0.12) (0.12)	3400 (3400) (3400) (3400)	18 (15) (15) (15)	3500 (3700) (3900) (3900)	10 × 12 (10 × 16)	0.12 (0.12)	4760 (4760)	20 (16)	3600 (4200)
1000	102	6.3 × 18 (8 × 12) (8 × 16) (10 × 12)	0.12 (0.12) (0.12) (0.12)	4100 (4100) (4100) (4100)	20 (25) (25) (25)	4000 (4000) (4000) (4000)	10 × 16	0.12	5740	16	4500
1500	152	8 × 16 (10 × 12) (10 × 16)	0.12 (0.12) (0.12)	5000 (5000) (5000)	25 (25) (25)	4500 (4500) (4500)	10 × 21	0.12	7000	16	4700
2200	222	10 × 16	0.12	7500	25	4800					
2700	272	10 × 21	0.12	11000	18	5400					

Note: All design and specifications are for reference only and is subject to change without prior notice. If any doubt about safety for your application, please contact us immediately for technical assistance before purchase.

注：以上所提供的設計及特性參數僅供參考，任何修改不作預先通知。如果在使用上有疑問，請在採購前與我們聯繫，以便提供技術上的協助。

CAT.2023/V2

PV Series

□ DIMENSIONS & STANDARD RATINGS 規格尺寸及標準參數

WV (V)		50 (1H)					63 (1J)				
Cap. 容量 (μF)	Parameter 參數	Case size ØD×L (mm) 尺寸	Dissipation factor (tan δ) 損耗角正切	Leakage current (μA) 漏電流	ESR (mΩ) max. 20°C, 100KHz 阻抗值	Ripple current (mA rms) 105°C, 100KHz 紋波電流	Case size ØD×L (mm) 尺寸	Dissipation factor (tan δ) 損耗角正切	Leakage current (μA) 漏電流	ESR (mΩ) max. 20°C, 100KHz 阻抗值	Ripple current (mA rms) 105°C, 100KHz 紋波電流
10	100	6.3 × 8	0.12	100	35	1850	6.3 × 8	0.12	126	38	1600
22	220	6.3 × 8	0.12	220	35	1900	6.3 × 8 (8 × 9)	0.12 (0.12)	277 (277)	38 (35)	1600 (1800)
27	270	6.3 × 8	0.12	270	35	2100	8 × 12	0.12	340	33	2100
33	330	8 × 9	0.12	330	32	1900	6.3 × 8	0.12	416	30	1700
39	390	8 × 12	0.12	390	29	2200	6.3 × 8	0.12	491	30	1750
47	470	6.3 × 8 (8 × 8)	0.12 (0.12)	470 (470)	35 (32)	2000 (2100)	10 × 13	0.12	592	29	2600
56	560	6.3 × 11	0.12	560	35	2100	10 × 12	0.12	705	29	2600
68	680	6.3 × 12	0.12	680	32	2250	8 × 12	0.12	857	30	2400
100	101	8 × 12	0.12	1000	28	2600	8 × 12 (10 × 12)	0.12 (0.12)	1260 (1260)	32 (28)	2400 (3000)
180	181	10 × 12	0.12	1800	26	3200	10 × 12	0.12	2268	27	3400
220	221	10 × 12	0.12	2200	22	3500	10 × 16	0.12	2772	22	3800
330	331	10 × 16	0.12	3300	20	4200	10 × 21	0.12	4158	20	4600
470	471	10 × 21	0.12	400	28	4200					

WV (V)		80 (1K)					100 (2A)				
Cap. 容量 (μF)	Parameter 參數	Case size ØD×L (mm) 尺寸	Dissipation factor (tan δ) 損耗角正切	Leakage current (μA) 漏電流	ESR (mΩ) max. 20°C, 100KHz 阻抗值	Ripple current (mA rms) 105°C, 100KHz 紋波電流	Case size ØD×L (mm) 尺寸	Dissipation factor (tan δ) 損耗角正切	Leakage current (μA) 漏電流	ESR (mΩ) max. 20°C, 100KHz 阻抗值	Ripple current (mA rms) 105°C, 100KHz 紋波電流
6.8	6R8	6.3 × 8	0.12	109	60	1550	8 × 9	0.12	136	45	1600
10	100	8 × 9	0.12	160	40	1700	6.3 × 11 (8 × 12)	0.12 (0.12)	200 (200)	50 (42)	1500 (1800)
12	120	8 × 12	0.12	192	38	1900					
15	150						8 × 12	0.12	300	42	1900
18	180						10 × 13	0.12	360	38	2200
22	220	10 × 13	0.12	352	35	2300	8 × 12	0.12	440	42	2100
47	470						10 × 16	0.12	940	35	2000
100	101						10 × 21	0.12	2000	32	3800

- Please refer to page 21 about the taped or cutting product spec. 編帶與剪腳標準請查閱第 21 頁。
- Please refer to page 18 for the minimum package quantity. 最小包裝數量請查閱第 18 頁。
- Please refer to page 14 for the Part Number System. 產品編碼規則請查閱第 14 頁。

Note: All design and specifications are for reference only and is subject to change without prior notice. If any doubt about safety for your application, please contact us immediately for technical assistance before purchase.

注：以上所提供的設計及特性參數僅供參考，任何修改不作預先通知。如果在使用上有疑問，請在採購前與我們聯繫，以便提供技術上的協助。

CAT.2023/V2

Conductive Polymer Hybrid Aluminum Electrolytic Capacitors (Chip & Radial Lead Type)
導電性高分子混合型鋁電解電容器 (貼片式及引線式)



Note: All design and specifications are for reference only and is subject to change without prior notice. If any doubt about safety for your application, please contact us immediately for technical assistance before purchase.

注：以上所提供的設計及特性參數僅供參考，任何修改不作預先通知。如果在使用上有疑問，請在採購前與我們聯繫，以便提供技術上的協助。

CAT.2023/V2

HMB Series

CHIP TYPE, LONG LIFE 貼片式，長壽命品

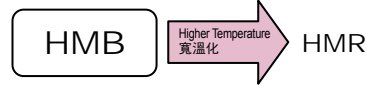

- Operating with wide temperature range -55~+105°C
適用於 -55~+105°C 的寬溫範圍
- High reliability & high voltage are realized by hybrid electrolyte
通過混合型電解質，提高可靠性和高電壓化
- Endurance 5000 hours
耐久性 5000 小時
- RoHS & REACH compliant, Halogen-free
符合 RoHS 與 REACH，無鹵
- AEC-Q200 compliant (Please contact us for details)
符合 AEC-Q200 (請與我們聯繫瞭解詳細信息)

□ SPECIFICATIONS 特性表

Items 項目	Characteristics 主要特性								
Category Temperature Range 工作溫度範圍	-55 ~ +105°C								
Voltage Range 額定工作電壓範圍	16 ~ 100V								
Capacitance Range 靜電容量範圍	22 ~ 1500µF								
Capacitance Tolerance 靜電容量允許偏差	±20% at 120Hz, 20°C								
Leakage Current 漏電流	Leakage current ≤0.01CV (after 2 minutes application of rated voltage at 20°C) 漏電流 ≤0.01CV (在 20°C 環境中施加額定工作電壓 2 分鐘後) C: Nominal capacitance (µF) 標稱靜電容量, V: Rated voltage (V) 額定電壓								
Dissipation Factor (tan δ) 損耗角正切	≤Specified value at 120Hz, 20°C. ≤規範值 (在 20°C 120Hz 環境下)。								
ESR 阻抗值	≤Specified value at 100KHz, 20°C. ≤規範值 (在 20°C 100KHz 環境下)。								
Stability at Low Temperature 低溫特性	Measurement frequency 測試頻率: 100KHz <table border="1"> <tr> <td>Impedance Ratio 阻抗比</td> <td>Z(-25°C)/Z(20°C)</td> <td>≤1.5</td> </tr> <tr> <td>ZT/Z20 (max.)</td> <td>Z(-55°C)/Z(20°C)</td> <td>≤2.0</td> </tr> </table>	Impedance Ratio 阻抗比	Z(-25°C)/Z(20°C)	≤1.5	ZT/Z20 (max.)	Z(-55°C)/Z(20°C)	≤2.0		
Impedance Ratio 阻抗比	Z(-25°C)/Z(20°C)	≤1.5							
ZT/Z20 (max.)	Z(-55°C)/Z(20°C)	≤2.0							
Damp Heat (Steady State) 穩態濕熱	When the capacitors are restored to 20°C after the rated voltage is applied for 2000 hours at 85°C, 85% RH, they meet the characteristics listed below. 在 85°C 和相對濕度 85% 環境下施加額定工作電壓 2000 小時並冷卻至 20°C 後，電容器的特性符合下表的要求。 <table border="1"> <tr> <td>Capacitance Change 靜電容量變化率</td> <td>Within ±30% of initial value 為初始值的±30%以內</td> </tr> <tr> <td>Dissipation Factor 損耗角正切</td> <td>200% or less of initial specified value 不大於規範值的 200%</td> </tr> <tr> <td>ESR 阻抗值</td> <td>200% or less of initial specified value 不大於規範值的 200%</td> </tr> <tr> <td>Leakage Current 漏電流</td> <td>Initial specified value or less 不大於規範值</td> </tr> </table>	Capacitance Change 靜電容量變化率	Within ±30% of initial value 為初始值的±30%以內	Dissipation Factor 損耗角正切	200% or less of initial specified value 不大於規範值的 200%	ESR 阻抗值	200% or less of initial specified value 不大於規範值的 200%	Leakage Current 漏電流	Initial specified value or less 不大於規範值
Capacitance Change 靜電容量變化率	Within ±30% of initial value 為初始值的±30%以內								
Dissipation Factor 損耗角正切	200% or less of initial specified value 不大於規範值的 200%								
ESR 阻抗值	200% or less of initial specified value 不大於規範值的 200%								
Leakage Current 漏電流	Initial specified value or less 不大於規範值								
Endurance 耐久性	After 5000 hours application of the rated voltage at 105°C, they meet the characteristics listed below. 在 105°C 環境中施加額定工作電壓 5000 小時後，電容器的特性符合下表的要求。 <table border="1"> <tr> <td>Capacitance Change 靜電容量變化率</td> <td>Within ±30% of initial value 為初始值的±30%以內</td> </tr> <tr> <td>Dissipation Factor 損耗角正切</td> <td>200% or less of initial specified value 不大於規範值的 200%</td> </tr> <tr> <td>ESR 阻抗值</td> <td>200% or less of initial specified value 不大於規範值的 200%</td> </tr> <tr> <td>Leakage Current 漏電流</td> <td>Initial specified value or less 不大於規範值</td> </tr> </table>	Capacitance Change 靜電容量變化率	Within ±30% of initial value 為初始值的±30%以內	Dissipation Factor 損耗角正切	200% or less of initial specified value 不大於規範值的 200%	ESR 阻抗值	200% or less of initial specified value 不大於規範值的 200%	Leakage Current 漏電流	Initial specified value or less 不大於規範值
Capacitance Change 靜電容量變化率	Within ±30% of initial value 為初始值的±30%以內								
Dissipation Factor 損耗角正切	200% or less of initial specified value 不大於規範值的 200%								
ESR 阻抗值	200% or less of initial specified value 不大於規範值的 200%								
Leakage Current 漏電流	Initial specified value or less 不大於規範值								
Shelf Life 高溫貯存特性	After leaving capacitors under no load at 105°C for 1000 hours, they meet the specified value for Endurance characteristics listed above. 在 105°C 環境中無負荷放置 1000 小時後，電容器的特性符合耐久性中所列的規定值。								
Resistance to Soldering Heat 耐焊接熱特性 (Please refer page 22 for soldering conditions) (焊接條件請查閱第 22 頁)	After reflow soldering and restored at room temperature, they meet the characteristics listed below. 經過回流焊並冷卻至室溫後，電容器的特性符合下表的要求。 <table border="1"> <tr> <td>Capacitance Change 靜電容量變化率</td> <td>Within ±10% of initial value 初始值的±10%以內</td> </tr> <tr> <td>Dissipation Factor 損耗角正切</td> <td>Initial specified value or less 不大於規範值</td> </tr> <tr> <td>ESR 阻抗值</td> <td>Initial specified value or less 不大於規範值</td> </tr> <tr> <td>Leakage Current 漏電流</td> <td>Initial specified value or less 不大於規範值</td> </tr> </table>	Capacitance Change 靜電容量變化率	Within ±10% of initial value 初始值的±10%以內	Dissipation Factor 損耗角正切	Initial specified value or less 不大於規範值	ESR 阻抗值	Initial specified value or less 不大於規範值	Leakage Current 漏電流	Initial specified value or less 不大於規範值
Capacitance Change 靜電容量變化率	Within ±10% of initial value 初始值的±10%以內								
Dissipation Factor 損耗角正切	Initial specified value or less 不大於規範值								
ESR 阻抗值	Initial specified value or less 不大於規範值								
Leakage Current 漏電流	Initial specified value or less 不大於規範值								
Marking 標識	Red print on the case top. 鋁殼頂部紅色字體印刷。								

□ DRAWING 外形圖 (Unit: mm)

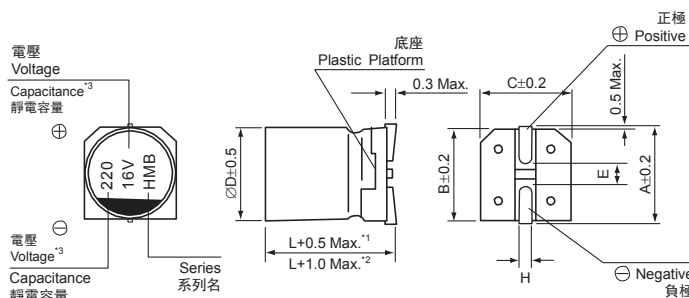

- *1. Applicable to Ø6.3 and Ø8 適用於Ø6.3和Ø8
- *2. Applicable to Ø10 and above 適用於Ø10和Ø10以上
- *3. Capacitance ≥1000µF 容量≥1000µF

Dimension table in next page.
尺寸表見下一頁。

Note: All design and specifications are for reference only and is subject to change without prior notice. If any doubt about safety for your application, please contact us immediately for technical assistance before purchase.

注: 以上所提供的設計及特性參數僅供參考，任何修改不作預先通知。如果在使用上有疑問，請在採購前與我們聯繫，以便提供技術上的協助。

CAT.2023/V2

HMB Series

□ DIMENSIONS 尺寸表 (Unit: mm)

∅D × L	6.3 × 6/6.5	6.3 × 7.7/9	8 × 10.5	8 × 12.5	10 × 10.5	10 × 12.5
A	7.3	7.3	9.0	9.0	11.0	11.0
B	6.6	6.6	8.3	8.3	10.3	10.3
C	6.6	6.6	8.3	8.3	10.3	10.3
E	1.9	1.9	3.1	3.1	4.7	4.7
L	6.0/6.5	7.7/9.0	10.5	12.5	10.5	12.5
H	0.5~0.8	0.5~0.8	0.8~1.1	0.8~1.1	0.8~1.1	0.8~1.1

□ DIMENSIONS & STANDARD RATINGS 規格尺寸及標準參數

Cap. 容量 (μF)	Parameter 參數	16 (1C)					25 (1E)				
		Case size ∅D×L (mm) 尺寸	Dissipation factor (tan δ) 損耗角正切	Leakage current (μA) 漏電流	ESR (mΩ) max. 20°C, 100KHz 阻抗值	Ripple current (mA rms) 105°C, 100KHz 紋波電流	Case size ∅D×L (mm) 尺寸	Dissipation factor (tan δ) 損耗角正切	Leakage current (μA) 漏電流	ESR (mΩ) max. 20°C, 100KHz 阻抗值	Ripple current (mA rms) 105°C, 100KHz 紋波電流
56	560						6.3 × 6.5	0.14	14	50	1300
68	680						6.3 × 6	0.14	17	50	1300
100	101	6.3 × 6	0.16	16	45	1600	6.3 × 7.7	0.14	25	30	2000
150	151						6.3 × 7.7	0.14	37.5	30	2000
220	221	6.3 × 7.7	0.16	24	30	2000	6.3 × 7.7	0.14	37.5	30	2000
270	271	6.3 × 7.7	0.16	35.2	27	2200	8 × 10.5 (6.3 × 9)	0.14 (0.14)	67.5 (55)	27 (30)	2300 (2000)
330	331						8 × 10.5 (10 × 10.5)	0.14 (0.14)	82.5 (82.5)	27 (20)	2300 (2500)
470	471	8 × 10.5 (10 × 10.5)	0.16 (0.16)	75.2 (75.2)	22 (18)	2500 (2600)	8 × 12.5 (10 × 10.5)	0.14 (0.14)	117.5 (117.5)	23 (20)	2600 (2500)
680	681						10 × 12.5	0.14	170	15	3000
820	821	8 × 12.5 (10 × 10.5)	0.16 (0.16)	131.2 (131.2)	20 (18)	2700 (2600)					
1500	152	10 × 12.5	0.16	240	14	3400					

Cap. 容量 (μF)	Parameter 參數	35 (1V)					50 (1H)				
		Case size ∅D×L (mm) 尺寸	Dissipation factor (tan δ) 損耗角正切	Leakage current (μA) 漏電流	ESR (mΩ) max. 20°C, 100KHz 阻抗值	Ripple current (mA rms) 105°C, 100KHz 紋波電流	Case size ∅D×L (mm) 尺寸	Dissipation factor (tan δ) 損耗角正切	Leakage current (μA) 漏電流	ESR (mΩ) max. 20°C, 100KHz 阻抗值	Ripple current (mA rms) 105°C, 100KHz 紋波電流
27	270						6.3 × 6	0.10	13.5	80	1100
33	330						6.3 × 7.7	0.10	16.5	40	1600
68	680	6.3 × 6 (6.3 × 7.7)	0.12 (0.12)	23.8 (23.8)	60 (55)	1300 (1500)	8 × 10.5	0.10	34	30	1800
100	101	6.3 × 7.7 (8 × 10.5)	0.12 (0.12)	35 (35)	35 (27)	2000 (2300)	8 × 10.5 (10 × 10.5)	0.10 (0.10)	50 (50)	30 (25)	1800 (2000)
120	121						8 × 12.5	0.10	60	28	2000
150	151	8 × 10.5	0.12	52.5	27	2300	10 × 10.5	0.10	75	25	2000
180	181	8 × 10.5	0.12	63	27	2300					
220	221	8 × 12.5	0.12	77	24	2500	10 × 12.5	0.12	110	23	2200
270	271	10 × 10.5	0.12	94.5	20	2500					
330	331	10 × 10.5	0.12	115.5	20	2500					
470	471	10 × 12.5	0.12	164.5	16	2900					

Cap. 容量 (μF)	Parameter 參數	63 (1J)					80 (1K)				
		Case size ∅D×L (mm) 尺寸	Dissipation factor (tan δ) 損耗角正切	Leakage current (μA) 漏電流	ESR (mΩ) max. 20°C, 100KHz 阻抗值	Ripple current (mA rms) 105°C, 100KHz 紋波電流	Case size ∅D×L (mm) 尺寸	Dissipation factor (tan δ) 損耗角正切	Leakage current (μA) 漏電流	ESR (mΩ) max. 20°C, 100KHz 阻抗值	Ripple current (mA rms) 105°C, 100KHz 紋波電流
22	220	6.3 × 7.7	0.08	13.86	80	1500	8 × 10.5	0.08	17.6	45	1600
33	330	8 × 10.5	0.08	20.79	40	1600	8 × 10.5	0.08	26.4	45	1600
47	470	8 × 10.5	0.08	29.61	40	1600	8 × 12.5 (10 × 10.5)	0.08 (0.08)	37.6 (37.6)	42 (36)	1750 (1700)
56	560	10 × 10.5	0.08	35.28	30	1800	10 × 10.5	0.08	44.8	36	1700
82	820						10 × 12.5	0.08	65.6	33	1850
100	101	8 × 10.5 (10 × 10.5)	0.08 (0.08)	63 (63)	36 (30)	1800 (1800)					
150	151	10 × 12.5	0.08	94.5	26	2000					

Note: All design and specifications are for reference only and is subject to change without prior notice. If any doubt about safety for your application, please contact us immediately for technical assistance before purchase.

注：以上所提供的設計及特性參數僅供參考，任何修改不作預先通知。如果在使用上有疑問，請在採購前與我們聯繫，以便提供技術上的協助。

CAT.2023/V2

HMB Series

□ DIMENSIONS & STANDARD RATINGS 規格尺寸及標準參數

WV (V)		100 (2A)				
Cap. 容量 (μF)	Parameter 參數	Case size ØD×L (mm) 尺寸	Dissipation factor (tan δ) 損耗角正切	Leakage current (μA) 漏電流	ESR (mΩ) max. 20°C, 100KHz 阻抗值	Ripple current (mA rms) 105°C, 100KHz 紋波電流
33	330	10 × 10.5	0.08	33	80	1400
47	470	10 × 12.5	0.08	47	60	1600

□ FREQUENCY COEFFICIENT OF ALLOWABLE RIPPLE CURRENT 紋波電流頻率補償系數

Frequency 頻率	120Hz ≤ f ≤ 1KHz	1KHz ≤ f ≤ 10KHz	10KHz ≤ f ≤ 100KHz	100KHz ≤ f ≤ 300KHz
Coefficient 系數	0.10	0.40	0.70	1.00

- Taping specifications are given in page 17. 編帶標準請查閱第 17 頁。
- Soldering conditions and recommended land size are given in page 22. 焊接條件及推薦安裝尺寸請查閱第 22 頁。
- Please refer to page 18 for the minimum package quantity. 最小包裝數量請查閱第 18 頁。
- Please refer to page 15 for the Part Number System. 產品編碼規則請查閱第 15 頁。

Note: All design and specifications are for reference only and is subject to change without prior notice. If any doubt about safety for your application, please contact us immediately for technical assistance before purchase.

注：以上所提供的設計及特性參數僅供參考，任何修改不作預先通知。如果在使用上有疑問，請在採購前與我們聯繫，以便提供技術上的協助。

CAT.2023/V2

HMR Series

CHIP TYPE, HIGH RELIABILITY 貼片式, 高可靠品

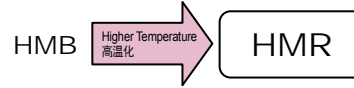

- Operating with wide temperature range -55~+125°C
適用於 -55~+125°C 的寬溫範圍
- High reliability & high voltage are realized by hybrid electrolyte
通過混合型電解質, 提升高可靠性和高電壓化
- Endurance 4000 hours
耐久性 4000 小時
- RoHS & REACH compliant, Halogen-free
符合 RoHS 與 REACH, 無鹵
- AEC-Q200 compliant (Please contact us for details)
符合 AEC-Q200 (請與我們聯繫瞭解詳細信息)

□ SPECIFICATIONS 特性表

Items 項目	Characteristics 主要特性								
Category Temperature Range 工作溫度範圍	-55 ~ +125°C								
Voltage Range 額定工作電壓範圍	16 ~ 100V								
Capacitance Range 靜電容量範圍	22 ~ 1500µF								
Capacitance Tolerance 靜電容量允許偏差	±20% at 120Hz, 20°C								
Leakage Current 漏電流	Leakage current ≤0.01CV (after 2 minutes application of rated voltage at 20°C) 漏電流 ≤0.01CV (在 20°C 環境中施加額定工作電壓 2 分鐘後) C: Nominal capacitance (µF) 標稱靜電容量, V: Rated voltage (V) 額定電壓								
Dissipation Factor (tan δ) 損耗角正切	≤Specified value at 120Hz, 20°C. ≤規範值 (在 20°C 120Hz 環境下)。								
ESR 阻抗值	≤Specified value at 100KHz, 20°C. ≤規範值 (在 20°C 100KHz 環境下)。								
Stability at Low Temperature 低溫特性	Measurement frequency 測試頻率: 100KHz <table border="1"> <tr> <td>Impedance Ratio 阻抗比 ZT/Z20 (max.)</td> <td>Z(-25°C)/Z(20°C)</td> <td>≤1.5</td> </tr> <tr> <td></td> <td>Z(-55°C)/Z(20°C)</td> <td>≤2.0</td> </tr> </table>	Impedance Ratio 阻抗比 ZT/Z20 (max.)	Z(-25°C)/Z(20°C)	≤1.5		Z(-55°C)/Z(20°C)	≤2.0		
Impedance Ratio 阻抗比 ZT/Z20 (max.)	Z(-25°C)/Z(20°C)	≤1.5							
	Z(-55°C)/Z(20°C)	≤2.0							
Damp Heat (Steady State) 穩態濕熱	When the capacitors are restored to 20°C after the rated voltage is applied for 2000 hours at 85°C, 85% RH, they meet the characteristics listed below. 在 85°C 和相對濕度 85% 環境下施加額定工作電壓 2000 小時並冷卻至 20°C 後, 電容器的特性符合下表的要求。 <table border="1"> <tr> <td>Capacitance Change 靜電容量變化率</td> <td>Within ±30% of initial value 為初始值的±30%以內</td> </tr> <tr> <td>Dissipation Factor 損耗角正切</td> <td>200% or less of initial specified value 不大於規範值的 200%</td> </tr> <tr> <td>ESR 阻抗值</td> <td>200% or less of initial specified value 不大於規範值的 200%</td> </tr> <tr> <td>Leakage Current 漏電流</td> <td>Initial specified value or less 不大於規範值</td> </tr> </table>	Capacitance Change 靜電容量變化率	Within ±30% of initial value 為初始值的±30%以內	Dissipation Factor 損耗角正切	200% or less of initial specified value 不大於規範值的 200%	ESR 阻抗值	200% or less of initial specified value 不大於規範值的 200%	Leakage Current 漏電流	Initial specified value or less 不大於規範值
Capacitance Change 靜電容量變化率	Within ±30% of initial value 為初始值的±30%以內								
Dissipation Factor 損耗角正切	200% or less of initial specified value 不大於規範值的 200%								
ESR 阻抗值	200% or less of initial specified value 不大於規範值的 200%								
Leakage Current 漏電流	Initial specified value or less 不大於規範值								
Endurance 耐久性	After 4000 hours application of the rated voltage at 125°C, they meet the characteristics listed below. 在 125°C 環境中施加額定工作電壓 4000 小時後, 電容器的特性符合下表的要求。 <table border="1"> <tr> <td>Capacitance Change 靜電容量變化率</td> <td>Within ±30% of initial value 為初始值的±30%以內</td> </tr> <tr> <td>Dissipation Factor 損耗角正切</td> <td>200% or less of initial specified value 不大於規範值的 200%</td> </tr> <tr> <td>ESR 阻抗值</td> <td>200% or less of initial specified value 不大於規範值的 200%</td> </tr> <tr> <td>Leakage Current 漏電流</td> <td>Initial specified value or less 不大於規範值</td> </tr> </table>	Capacitance Change 靜電容量變化率	Within ±30% of initial value 為初始值的±30%以內	Dissipation Factor 損耗角正切	200% or less of initial specified value 不大於規範值的 200%	ESR 阻抗值	200% or less of initial specified value 不大於規範值的 200%	Leakage Current 漏電流	Initial specified value or less 不大於規範值
Capacitance Change 靜電容量變化率	Within ±30% of initial value 為初始值的±30%以內								
Dissipation Factor 損耗角正切	200% or less of initial specified value 不大於規範值的 200%								
ESR 阻抗值	200% or less of initial specified value 不大於規範值的 200%								
Leakage Current 漏電流	Initial specified value or less 不大於規範值								
Shelf Life 高溫貯存特性	After leaving capacitors under no load at 125°C for 1000 hours, they meet the specified value for Endurance characteristics listed above. 在 125°C 環境中無負荷放置 1000 小時後, 電容器的特性符合耐久性中所列的規定值。								
Resistance to Soldering Heat 耐焊接熱特性 (Please refer page 22 for soldering conditions) (焊接條件請查閱第 22 頁)	After reflow soldering and restored at room temperature, they meet the characteristics listed below. 經過回流焊並冷卻至室溫後, 電容器的特性符合下表的要求。 <table border="1"> <tr> <td>Capacitance Change 靜電容量變化率</td> <td>Within ±10% of initial value 初始值的±10%以內</td> </tr> <tr> <td>Dissipation Factor 損耗角正切</td> <td>130% or less of initial specified value 不大於規範值的 130%</td> </tr> <tr> <td>ESR 阻抗值</td> <td>130% or less of initial specified value 不大於規範值的 130%</td> </tr> <tr> <td>Leakage Current 漏電流</td> <td>Initial specified value or less 不大於規範值</td> </tr> </table>	Capacitance Change 靜電容量變化率	Within ±10% of initial value 初始值的±10%以內	Dissipation Factor 損耗角正切	130% or less of initial specified value 不大於規範值的 130%	ESR 阻抗值	130% or less of initial specified value 不大於規範值的 130%	Leakage Current 漏電流	Initial specified value or less 不大於規範值
Capacitance Change 靜電容量變化率	Within ±10% of initial value 初始值的±10%以內								
Dissipation Factor 損耗角正切	130% or less of initial specified value 不大於規範值的 130%								
ESR 阻抗值	130% or less of initial specified value 不大於規範值的 130%								
Leakage Current 漏電流	Initial specified value or less 不大於規範值								
Marking 標識	Red print on the case top. 鋁殼頂部紅色字體印刷。								

□ DRAWING 外形圖 (Unit: mm)

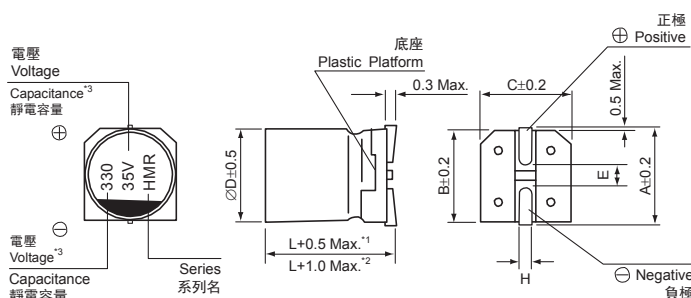

- *1. Applicable to Ø6.3 and Ø8 適用於Ø6.3和Ø8
- *2. Applicable to Ø10 and above 適用於Ø10和Ø10以上
- *3. Capacitance ≥1000µF 容量≥1000µF

Dimension table in next page.
尺寸表見下一頁。

Note: All design and specifications are for reference only and is subject to change without prior notice. If any doubt about safety for your application, please contact us immediately for technical assistance before purchase.

注: 以上所提供的設計及特性參數僅供參考, 任何修改不作預先通知。如果在使用上有疑問, 請在採購前與我們聯繫, 以便提供技術上的協助。

CAT.2023/V2

HMR Series

□ DIMENSIONS 尺寸表 (Unit: mm)

∅D × L	6.3 × 5.8/6	6.3 × 7.7	8 × 10.5	8 × 12.5	10 × 10.5	10 × 12.5
A	7.3	7.3	9.0	9.0	11.0	11.0
B	6.6	6.6	8.3	8.3	10.3	10.3
C	6.6	6.6	8.3	8.3	10.3	10.3
E	1.9	1.9	3.1	3.1	4.7	4.7
L	5.8/6.0	7.7	10.5	12.5	10.5	12.5
H	0.5~0.8	0.5~0.8	0.8~1.1	0.8~1.1	0.8~1.1	0.8~1.1

□ DIMENSIONS & STANDARD RATINGS 規格尺寸及標準參數

Cap. 容量 (μF)	Parameter 參數	16 (1C)					25 (1E)				
		Case size ∅D×L (mm) 尺寸	Dissipation factor (tan δ) 損耗角正切	Leakage current (μA) 漏電流	ESR (mΩ) max. 20°C, 100KHz 阻抗值	Ripple current (mA rms) 125°C, 100KHz 紋波電流	Case size ∅D×L (mm) 尺寸	Dissipation factor (tan δ) 損耗角正切	Leakage current (μA) 漏電流	ESR (mΩ) max. 20°C, 100KHz 阻抗值	Ripple current (mA rms) 125°C, 100KHz 紋波電流
68	680						6.3 × 6	0.14	17	50	900
100	101	6.3 × 6	0.16	16	45	950	6.3 × 7.7	0.14	25	30	1400
150	151						6.3 × 7.7	0.14	37.5	30	1400
220	221	6.3 × 7.7	0.16	35.2	27	1450	8 × 10.5	0.14	67.5	27	1600
270	271	8 × 10.5	0.16	43.2	22	1700	8 × 10.5	0.14	67.5	27	1600
330	331						8 × 10.5 (10 × 10.5)	0.14 (0.14)	82.5 (82.5)	27 (20)	1600 (2000)
470	471	8 × 10.5 (10 × 10.5)	0.16 (0.16)	75.2 (75.2)	22 (18)	1700 (2100)	8 × 12.5 (10 × 10.5)	0.14 (0.14)	117.5 (117.5)	23 (20)	1900 (2000)
680	681						10 × 12.5	0.14	170	15	2700
820	821	8 × 12.5 (10 × 10.5)	0.16 (0.16)	131.2 (131.2)	20 (18)	1850 (2100)					
1500	152	10 × 12.5	0.16	240	14	3000					

Cap. 容量 (μF)	Parameter 參數	35 (1V)					50 (1H)				
		Case size ∅D×L (mm) 尺寸	Dissipation factor (tan δ) 損耗角正切	Leakage current (μA) 漏電流	ESR (mΩ) max. 20°C, 100KHz 阻抗值	Ripple current (mA rms) 125°C, 100KHz 紋波電流	Case size ∅D×L (mm) 尺寸	Dissipation factor (tan δ) 損耗角正切	Leakage current (μA) 漏電流	ESR (mΩ) max. 20°C, 100KHz 阻抗值	Ripple current (mA rms) 125°C, 100KHz 紋波電流
22	220						6.3 × 5.8	0.10	11	80	750
27	270						6.3 × 6	0.10	13.5	80	750
33	330						6.3 × 7.7	0.10	16.5	40	1100
47	470	6.3 × 5.8	0.12	16.45	60	900					
68	680	6.3 × 6	0.12	23.8	60	900	8 × 10.5	0.10	34	30	1250
100	101	6.3 × 7.7 (8 × 9)	0.12 (0.12)	35 (35)	35 (30)	1400 (1600)	8 × 10.5 (10 × 10.5)	0.10 (0.10)	50 (50)	30 (25)	1150 (1600)
120	121						8 × 12.5	0.10	60	28	1400
150	151	8 × 10.5	0.12	52.5	27	1600	10 × 10.5	0.10	75	25	1600
180	181	8 × 10.5	0.12	63	27	1600					
220	221	8 × 10.5 (8 × 12.5)	0.12 (0.12)	77 (77)	27 (24)	1600 (1800)	10 × 12.5	0.12	110	23	1800
270	271	10 × 10.5	0.12	94.5	20	2000					
330	331	10 × 10.5	0.12	115.5	20	2000					
470	471	10 × 12.5	0.12	164.5	16	2600					

Cap. 容量 (μF)	Parameter 參數	63 (1J)					80 (1K)				
		Case size ∅D×L (mm) 尺寸	Dissipation factor (tan δ) 損耗角正切	Leakage current (μA) 漏電流	ESR (mΩ) max. 20°C, 100KHz 阻抗值	Ripple current (mA rms) 125°C, 100KHz 紋波電流	Case size ∅D×L (mm) 尺寸	Dissipation factor (tan δ) 損耗角正切	Leakage current (μA) 漏電流	ESR (mΩ) max. 20°C, 100KHz 阻抗值	Ripple current (mA rms) 125°C, 100KHz 紋波電流
22	220	6.3 × 7.7	0.08	13.86	80	900	8 × 10.5	0.08	17.6	45	1050
33	330	8 × 10.5	0.08	20.79	40	1100	8 × 10.5	0.08	26.4	45	1050
47	470	8 × 10.5	0.08	29.61	40	1100	8 × 12.5 (10 × 10.5)	0.08 (0.08)	37.6 (37.6)	42 (36)	1200 (1200)
56	560	10 × 10.5	0.08	35.28	30	1400	10 × 10.5	0.08	44.8	36	1200
82	820						10 × 12.5	0.08	65.6	33	1350
100	101	8 × 10.5 (10 × 10.5)	0.08 (0.08)	63 (63)	36 (30)	1300 (1400)					
150	151	10 × 12.5	0.08	94.5	26	1600					

Note: All design and specifications are for reference only and is subject to change without prior notice. If any doubt about safety for your application, please contact us immediately for technical assistance before purchase.

注：以上所提供的設計及特性參數僅供參考，任何修改不作預先通知。如果在使用上有疑問，請在採購前與我們聯繫，以便提供技術上的協助。

CAT.2023/V2

HMR Series

□ DIMENSIONS & STANDARD RATINGS 規格尺寸及標準參數

WV (V)		100 (2A)				
Cap. 容量 (μF)	Parameter 參數	Case size ØD×L (mm) 尺寸	Dissipation factor (tan δ) 損耗角正切	Leakage current (μA) 漏電流	ESR (mΩ) max. 20°C, 100KHz 阻抗值	Ripple current (mA rms) 125°C, 100KHz 紋波電流
33	330	10 × 10.5	0.08	33	80	850
47	470	10 × 12.5	0.08	47	60	1050

□ FREQUENCY COEFFICIENT OF ALLOWABLE RIPPLE CURRENT 紋波電流頻率補償系數

Frequency 頻率	120Hz ≤ f ≤ 1KHz	1KHz ≤ f ≤ 10KHz	10KHz ≤ f ≤ 100KHz	100KHz ≤ f ≤ 300KHz
Coefficient 系數	0.10	0.40	0.70	1.00

- Taping specifications are given in page 17. 編帶標準請查閱第 17 頁。
- Soldering conditions and recommended land size are given in page 22. 焊接條件及推薦安裝尺寸請查閱第 22 頁。
- Please refer to page 18 for the minimum package quantity. 最小包裝數量請查閱第 18 頁。
- Please refer to page 15 for the Part Number System. 產品編碼規則請查閱第 15 頁。

Note: All design and specifications are for reference only and is subject to change without prior notice. If any doubt about safety for your application, please contact us immediately for technical assistance before purchase.

注：以上所提供的設計及特性參數僅供參考，任何修改不作預先通知。如果在使用上有疑問，請在採購前與我們聯繫，以便提供技術上的協助。

CAT.2023/V2

HMX Series New 新品

CHIP TYPE, LONG LIFE 貼片式，長壽命品

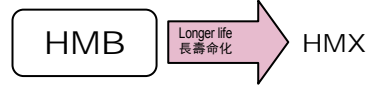

- Operating with wide temperature range -55~+105°C
適用於 -55~+105°C 的寬溫範圍
- High reliability & high voltage are realized by hybrid electrolyte
通過混合型電解質，提高可靠性和高電壓化
- Endurance 10000 hours
耐久性 10000 小時
- RoHS & REACH compliant, Halogen-free
符合 RoHS 與 REACH，無鹵
- AEC-Q200 compliant (Please contact us for details)
符合 AEC-Q200 (請與我們聯繫瞭解詳細信息)

□ SPECIFICATIONS 特性表

Items 項目	Characteristics 主要特性								
Category Temperature Range 工作溫度範圍	-55 ~ +105°C								
Voltage Range 額定工作電壓範圍	25 ~ 80V								
Capacitance Range 靜電容量範圍	10 ~ 330µF								
Capacitance Tolerance 靜電容量允許偏差	±20% at 120Hz, 20°C								
Leakage Current 漏電流	Leakage current ≤0.01CV (after 2 minutes application of rated voltage at 20°C) 漏電流 ≤0.01CV (在 20°C 環境中施加額定工作電壓 2 分鐘後) C: Nominal capacitance (µF) 標稱靜電容量, V: Rated voltage (V) 額定電壓								
Dissipation Factor (tan δ) 損耗角正切	≤Specified value at 120Hz, 20°C. ≤規範值 (在 20°C 120Hz 環境下)。								
ESR 阻抗值	≤Specified value at 100KHz, 20°C. ≤規範值 (在 20°C 100KHz 環境下)。								
Stability at Low Temperature 低溫特性	Measurement frequency 測試頻率: 100KHz <table border="1" style="width: 100%;"> <tr> <td>Impedance Ratio 阻抗比 ZT/Z20 (max.)</td> <td>Z(-25°C)/Z(20°C)</td> <td>≤1.5</td> </tr> <tr> <td></td> <td>Z(-55°C)/Z(20°C)</td> <td>≤2.0</td> </tr> </table>	Impedance Ratio 阻抗比 ZT/Z20 (max.)	Z(-25°C)/Z(20°C)	≤1.5		Z(-55°C)/Z(20°C)	≤2.0		
Impedance Ratio 阻抗比 ZT/Z20 (max.)	Z(-25°C)/Z(20°C)	≤1.5							
	Z(-55°C)/Z(20°C)	≤2.0							
Damp Heat (Steady State) 穩態濕熱	When the capacitors are restored to 20°C after the rated voltage is applied for 2000 hours at 105°C, 85% RH, they meet the characteristics listed below. 在 105°C 和相對濕度 85% 環境下施加額定工作電壓 2000 小時並冷卻至 20°C 後，電容器的特性符合下表的要求。 <table border="1" style="width: 100%;"> <tr> <td>Capacitance Change 靜電容量變化率</td> <td>Within ±30% of initial value 為初始值的±30%以內</td> </tr> <tr> <td>Dissipation Factor 損耗角正切</td> <td>200% or less of initial specified value 不大於規範值的 200%</td> </tr> <tr> <td>ESR 阻抗值</td> <td>200% or less of initial specified value 不大於規範值的 200%</td> </tr> <tr> <td>Leakage Current 漏電流</td> <td>Initial specified value or less 不大於規範值</td> </tr> </table>	Capacitance Change 靜電容量變化率	Within ±30% of initial value 為初始值的±30%以內	Dissipation Factor 損耗角正切	200% or less of initial specified value 不大於規範值的 200%	ESR 阻抗值	200% or less of initial specified value 不大於規範值的 200%	Leakage Current 漏電流	Initial specified value or less 不大於規範值
Capacitance Change 靜電容量變化率	Within ±30% of initial value 為初始值的±30%以內								
Dissipation Factor 損耗角正切	200% or less of initial specified value 不大於規範值的 200%								
ESR 阻抗值	200% or less of initial specified value 不大於規範值的 200%								
Leakage Current 漏電流	Initial specified value or less 不大於規範值								
Endurance 耐久性	After 10000 hours application of the rated voltage at 105°C, they meet the characteristics listed below. 在 105°C 環境中施加額定工作電壓 10000 小時後，電容器的特性符合下表的要求。 <table border="1" style="width: 100%;"> <tr> <td>Capacitance Change 靜電容量變化率</td> <td>Within ±30% of initial value 為初始值的±30%以內</td> </tr> <tr> <td>Dissipation Factor 損耗角正切</td> <td>200% or less of initial specified value 不大於規範值的 200%</td> </tr> <tr> <td>ESR 阻抗值</td> <td>200% or less of initial specified value 不大於規範值的 200%</td> </tr> <tr> <td>Leakage Current 漏電流</td> <td>Initial specified value or less 不大於規範值</td> </tr> </table>	Capacitance Change 靜電容量變化率	Within ±30% of initial value 為初始值的±30%以內	Dissipation Factor 損耗角正切	200% or less of initial specified value 不大於規範值的 200%	ESR 阻抗值	200% or less of initial specified value 不大於規範值的 200%	Leakage Current 漏電流	Initial specified value or less 不大於規範值
Capacitance Change 靜電容量變化率	Within ±30% of initial value 為初始值的±30%以內								
Dissipation Factor 損耗角正切	200% or less of initial specified value 不大於規範值的 200%								
ESR 阻抗值	200% or less of initial specified value 不大於規範值的 200%								
Leakage Current 漏電流	Initial specified value or less 不大於規範值								
Shelf Life 高溫貯存特性	After leaving capacitors under no load at 105°C for 1000 hours, they meet the specified value for Endurance characteristics listed above. 在 105°C 環境中無負荷放置 1000 小時後，電容器的特性符合耐久性中所列的規定值。								
Resistance to Soldering Heat 耐焊接熱特性 <small>(Please refer page 22 for soldering conditions) (焊接條件請查閱第 22 頁)</small>	After reflow soldering and restored at room temperature, they meet the characteristics listed below. 經過回流焊並冷卻至室溫後，電容器的特性符合下表的要求。 <table border="1" style="width: 100%;"> <tr> <td>Capacitance Change 靜電容量變化率</td> <td>Within ±10% of initial value 初始值的±10%以內</td> </tr> <tr> <td>Dissipation Factor 損耗角正切</td> <td>Initial specified value or less 不大於規範值</td> </tr> <tr> <td>ESR 阻抗值</td> <td>Initial specified value or less 不大於規範值</td> </tr> <tr> <td>Leakage Current 漏電流</td> <td>Initial specified value or less 不大於規範值</td> </tr> </table>	Capacitance Change 靜電容量變化率	Within ±10% of initial value 初始值的±10%以內	Dissipation Factor 損耗角正切	Initial specified value or less 不大於規範值	ESR 阻抗值	Initial specified value or less 不大於規範值	Leakage Current 漏電流	Initial specified value or less 不大於規範值
Capacitance Change 靜電容量變化率	Within ±10% of initial value 初始值的±10%以內								
Dissipation Factor 損耗角正切	Initial specified value or less 不大於規範值								
ESR 阻抗值	Initial specified value or less 不大於規範值								
Leakage Current 漏電流	Initial specified value or less 不大於規範值								
Marking 標識	Red print on the case top. 鋁殼頂部紅色字體印刷。								

□ DRAWING 外形圖 (Unit: mm)

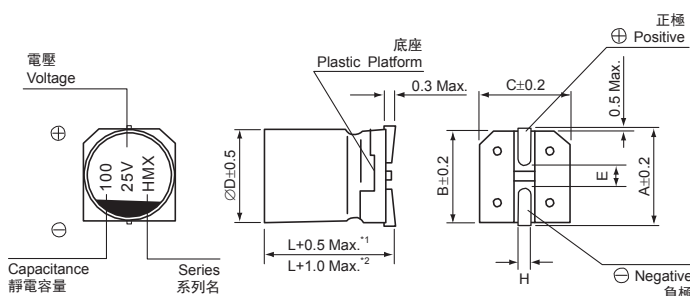

- *1. Applicable to Ø5~Ø8 適用於Ø5~Ø8
- *2. Applicable to Ø10 and above 適用於Ø10和Ø10以上

Dimension table in next page.
尺寸表見下一頁。

Note: All design and specifications are for reference only and is subject to change without prior notice. If any doubt about safety for your application, please contact us immediately for technical assistance before purchase.

注: 以上所提供的設計及特性參數僅供參考，任何修改不作預先通知。如果在使用上有疑問，請在採購前與我們聯繫，以便提供技術上的協助。

CAT.2023/V2

HMX Series New 新品

□ DIMENSIONS 尺寸表 (Unit: mm)

∅D × L	5 × 5.8	6.3 × 7.7	8 × 10.5	10 × 10.5
A	6.0	7.3	9.0	11.0
B	5.3	6.6	8.3	10.3
C	5.3	6.6	8.3	10.3
E	1.6	1.9	3.1	4.7
L	5.8	7.7	10.5	10.5
H	0.5~0.8	0.5~0.8	0.8~1.1	0.8~1.1

□ DIMENSIONS & STANDARD RATINGS 規格尺寸及標準參數

Cap. 容量 (μF)	Parameter 參數	25 (1E)					35 (1V)				
		Case size ∅D×L (mm) 尺寸	Dissipation factor (tan δ) 損耗角正切	Leakage current (μA) 漏電流	ESR (mΩ) max. 20°C, 100KHz 阻抗值	Ripple current (mA rms) 105°C, 100KHz 紋波電流	Case size ∅D×L (mm) 尺寸	Dissipation factor (tan δ) 損耗角正切	Leakage current (μA) 漏電流	ESR (mΩ) max. 20°C, 100KHz 阻抗值	Ripple current (mA rms) 105°C, 100KHz 紋波電流
10	100						5 × 5.8	0.12	3.5	100	900
22	220	5 × 5.8	0.14	5.5	80	900	5 × 5.8	0.12	7.7	100	900
33	330	5 × 5.8	0.14	8.25	80	900	6.3 × 5.8	0.12	11.55	60	1300
47	470	6.3 × 5.8	0.14	11.75	50	1300	6.3 × 5.8	0.12	16.45	60	1300
68	680	6.3 × 7.7	0.14	17	30	2000	6.3 × 7.7	0.12	23.8	35	2000
100	101	6.3 × 7.7	0.14	25	30	2000	8 × 10.5	0.12	35	27	2300
150	151	8 × 10.5	0.14	37.5	27	2300	8 × 10.5	0.12	52.5	27	2300
220	221	8 × 10.5	0.14	55	27	2300	10 × 10.5	0.12	77	20	2500
270	271						10 × 10.5	0.12	94.5	20	2500
330	331	10 × 10.5	0.14	82.5	20	2500					

Cap. 容量 (μF)	Parameter 參數	50 (1H)					63 (1J)				
		Case size ∅D×L (mm) 尺寸	Dissipation factor (tan δ) 損耗角正切	Leakage current (μA) 漏電流	ESR (mΩ) max. 20°C, 100KHz 阻抗值	Ripple current (mA rms) 105°C, 100KHz 紋波電流	Case size ∅D×L (mm) 尺寸	Dissipation factor (tan δ) 損耗角正切	Leakage current (μA) 漏電流	ESR (mΩ) max. 20°C, 100KHz 阻抗值	Ripple current (mA rms) 105°C, 100KHz 紋波電流
10	100	5 × 5.8	0.10	5	120	750	6.3 × 5.8	0.08	6.3	120	1000
22	220	6.3 × 5.8	0.10	11	80	1100	6.3 × 7.7	0.08	13.86	80	1500
33	330	6.3 × 7.7	0.10	16.5	40	1600	8 × 10.5	0.08	20.79	40	1700
47	470	8 × 10.5	0.10	23.5	30	1800	8 × 10.5	0.08	29.61	40	1700
56	560						10 × 10.5	0.08	35.28	30	1800
68	680	8 × 10.5	0.10	34	30	1800	10 × 10.5	0.08	42.84	30	1800
82	820						10 × 10.5	0.08	51.66	30	1800
100	101	10 × 10.5	0.10	50	28	2000					

Cap. 容量 (μF)	Parameter 參數	80 (1K)				
		Case size ∅D×L (mm) 尺寸	Dissipation factor (tan δ) 損耗角正切	Leakage current (μA) 漏電流	ESR (mΩ) max. 20°C, 100KHz 阻抗值	Ripple current (mA rms) 105°C, 100KHz 紋波電流
22	220	8 × 10.5	0.08	17.6	45	1550
33	330	10 × 10.5	0.08	26.4	36	1700
47	470	10 × 10.5	0.08	37.6	36	1700

□ FREQUENCY COEFFICIENT OF ALLOWABLE RIPPLE CURRENT 紋波電流頻率補償係數

Frequency 頻率	120Hz ≤ f ≤ 1KHz	1KHz ≤ f ≤ 10KHz	10KHz ≤ f ≤ 100KHz	100KHz ≤ f ≤ 300KHz
Coefficient 係數	0.10	0.40	0.70	1.00

- Taping specifications are given in page 12. 編帶標準請查閱第 12 頁。
- Soldering conditions and recommended land size are given in page 15. 焊接條件及推薦安裝尺寸請查閱第 15 頁。
- Please refer to page 13 for the minimum package quantity. 最小包裝數量請查閱第 13 頁。
- Please refer to page 11 for the Part Number System. 產品編碼規則請查閱第 11 頁。

Note: All design and specifications are for reference only and is subject to change without prior notice. If any doubt about safety for your application, please contact us immediately for technical assistance before purchase.

注: 以上所提供的設計及特性參數僅供參考, 任何修改不作預先通知。如果在使用上有疑問, 請在採購前與我們聯繫, 以便提供技術上的協助。

CAT.2023/V2

HPB Series

RADIAL LEAD TYPE, LONG LIFE 插件式，長壽命品

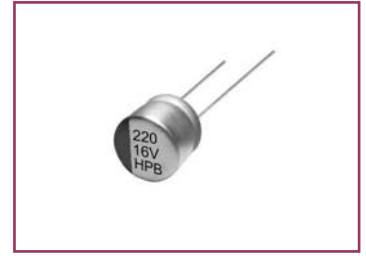

- Operating with wide temperature range -55~+105°C
適用於 -55~+105°C 的寬溫範圍
- High reliability & high voltage are realized by hybrid electrolyte
通過混合型電解質，提升高可靠性和高電壓化
- Endurance 5000 hours
耐久性 5000 小時
- RoHS & REACH compliant, Halogen-free
符合 RoHS 與 REACH，無鹵
- AEC-Q200 compliant (Please contact us for details)
符合 AEC-Q200 (請與我們聯繫瞭解詳細信息)

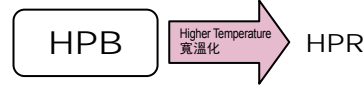

□ SPECIFICATIONS 特性表

Items 項目	Characteristics 主要特性								
Category Temperature Range 工作溫度範圍	-55 ~ +105°C								
Voltage Range 額定工作電壓範圍	16 ~ 100V								
Capacitance Range 靜電容量範圍	47 ~ 1500µF								
Capacitance Tolerance 靜電容量允許偏差	±20% at 120Hz, 20°C								
Leakage Current 漏電流	Leakage current ≤0.01CV (after 2 minutes application of rated voltage at 20°C) 漏電流 ≤0.01CV (在 20°C 環境中施加額定工作電壓 2 分鐘後) C: Nominal capacitance (µF) 標稱靜電容量, V: Rated voltage (V) 額定電壓								
Dissipation Factor (tan δ) 損耗角正切	≤Specified value at 120Hz, 20°C. ≤規範值 (在 20°C 120Hz 環境下)。								
ESR 阻抗值	≤Specified value at 100KHz, 20°C. ≤規範值 (在 20°C 100KHz 環境下)。								
Stability at Low Temperature 低溫特性	Measurement frequency 測試頻率: 100KHz <table border="1"> <tr> <td>Impedance Ratio 阻抗比</td> <td>Z(-25°C)/Z(20°C)</td> <td>≤1.5</td> </tr> <tr> <td>ZT/Z20 (max.)</td> <td>Z(-55°C)/Z(20°C)</td> <td>≤2.0</td> </tr> </table>	Impedance Ratio 阻抗比	Z(-25°C)/Z(20°C)	≤1.5	ZT/Z20 (max.)	Z(-55°C)/Z(20°C)	≤2.0		
Impedance Ratio 阻抗比	Z(-25°C)/Z(20°C)	≤1.5							
ZT/Z20 (max.)	Z(-55°C)/Z(20°C)	≤2.0							
Damp Heat (Steady State) 穩態濕熱	When the capacitors are restored to 20°C after the rated voltage is applied for 2000 hours at 85°C, 85% RH, they meet the characteristics listed below. 在 85°C 和相對濕度 85% 環境下施加額定工作電壓 2000 小時並冷卻至 20°C 後，電容器的特性符合下表的要求。 <table border="1"> <tr> <td>Capacitance Change 靜電容量變化率</td> <td>Within ±30% of initial value 為初始值的±30%以內</td> </tr> <tr> <td>Dissipation Factor 損耗角正切</td> <td>200% or less of initial specified value 不大於規範值的 200%</td> </tr> <tr> <td>ESR 阻抗值</td> <td>200% or less of initial specified value 不大於規範值的 200%</td> </tr> <tr> <td>Leakage Current 漏電流</td> <td>Initial specified value or less 不大於規範值</td> </tr> </table>	Capacitance Change 靜電容量變化率	Within ±30% of initial value 為初始值的±30%以內	Dissipation Factor 損耗角正切	200% or less of initial specified value 不大於規範值的 200%	ESR 阻抗值	200% or less of initial specified value 不大於規範值的 200%	Leakage Current 漏電流	Initial specified value or less 不大於規範值
Capacitance Change 靜電容量變化率	Within ±30% of initial value 為初始值的±30%以內								
Dissipation Factor 損耗角正切	200% or less of initial specified value 不大於規範值的 200%								
ESR 阻抗值	200% or less of initial specified value 不大於規範值的 200%								
Leakage Current 漏電流	Initial specified value or less 不大於規範值								
Endurance 耐久性	After 5000 hours application of the rated voltage at 105°C, they meet the characteristics listed below. 在 105°C 環境中施加額定工作電壓 5000 小時後，電容器的特性符合下表的要求。 <table border="1"> <tr> <td>Capacitance Change 靜電容量變化率</td> <td>Within ±30% of initial value 為初始值的±30%以內</td> </tr> <tr> <td>Dissipation Factor 損耗角正切</td> <td>200% or less of initial specified value 不大於規範值的 200%</td> </tr> <tr> <td>ESR 阻抗值</td> <td>200% or less of initial specified value 不大於規範值的 200%</td> </tr> <tr> <td>Leakage Current 漏電流</td> <td>Initial specified value or less 不大於規範值</td> </tr> </table>	Capacitance Change 靜電容量變化率	Within ±30% of initial value 為初始值的±30%以內	Dissipation Factor 損耗角正切	200% or less of initial specified value 不大於規範值的 200%	ESR 阻抗值	200% or less of initial specified value 不大於規範值的 200%	Leakage Current 漏電流	Initial specified value or less 不大於規範值
Capacitance Change 靜電容量變化率	Within ±30% of initial value 為初始值的±30%以內								
Dissipation Factor 損耗角正切	200% or less of initial specified value 不大於規範值的 200%								
ESR 阻抗值	200% or less of initial specified value 不大於規範值的 200%								
Leakage Current 漏電流	Initial specified value or less 不大於規範值								
Shelf Life 高溫貯存特性	After leaving capacitors under no load at 105°C for 1000 hours, they meet the specified value for Endurance characteristics listed above. 在 105°C 環境中無負荷放置 1000 小時後，電容器的特性符合耐久性中所列的規定值。								
Resistance to Soldering Heat 耐焊接熱特性 (Please refer page 9 for soldering conditions) (焊接條件請查閱第 12 頁)	After reflow soldering and restored at room temperature, they meet the characteristics listed below. 經過回流焊並冷卻至室溫後，電容器的特性符合下表的要求。 <table border="1"> <tr> <td>Capacitance Change 靜電容量變化率</td> <td>Within ±10% of initial value 初始值的±10%以內</td> </tr> <tr> <td>Dissipation Factor 損耗角正切</td> <td>Initial specified value or less 不大於規範值</td> </tr> <tr> <td>ESR 阻抗值</td> <td>Initial specified value or less 不大於規範值</td> </tr> <tr> <td>Leakage Current 漏電流</td> <td>Initial specified value or less 不大於規範值</td> </tr> </table>	Capacitance Change 靜電容量變化率	Within ±10% of initial value 初始值的±10%以內	Dissipation Factor 損耗角正切	Initial specified value or less 不大於規範值	ESR 阻抗值	Initial specified value or less 不大於規範值	Leakage Current 漏電流	Initial specified value or less 不大於規範值
Capacitance Change 靜電容量變化率	Within ±10% of initial value 初始值的±10%以內								
Dissipation Factor 損耗角正切	Initial specified value or less 不大於規範值								
ESR 阻抗值	Initial specified value or less 不大於規範值								
Leakage Current 漏電流	Initial specified value or less 不大於規範值								
Marking 標識	Red print on the case top. 鋁殼頂部紅色字體印刷。								

□ DRAWING 外形圖 (Unit: mm)

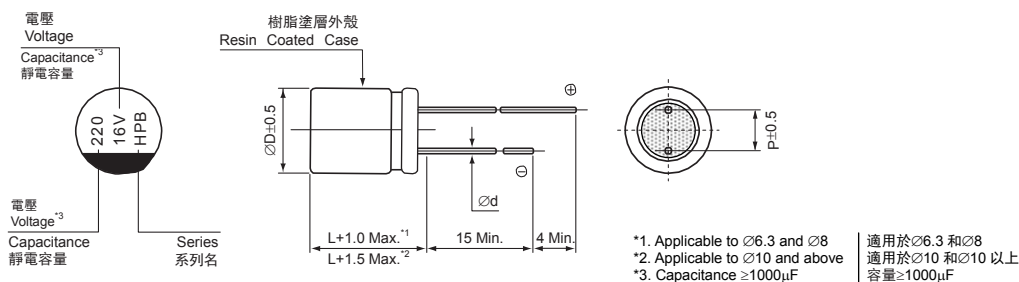

Dimension table in next page.
尺寸表見下一頁。

Note: All design and specifications are for reference only and is subject to change without prior notice. If any doubt about safety for your application, please contact us immediately for technical assistance before purchase.

注: 以上所提供的設計及特性參數僅供參考，任何修改不作預先通知。如果在使用上有疑問，請在採購前與我們聯繫，以便提供技術上的協助。

CAT.2023/V2

HPB Series

□ DIMENSIONS 尺寸表 (Unit: mm)

∅D × L	6.3 × 7	6.3 × 11.5	8 × 12	10 × 12
P	2.5	2.5	3.5	5.0
∅d	0.5	0.6	0.6	0.6
L	7.0	11.5	12.0	12.0

□ DIMENSIONS & STANDARD RATINGS 規格尺寸及標準參數

WV (V)		16 (1C)					25 (1E)				
Cap. 容量 (μF)	Parameter 參數	Case size ∅D×L (mm) 尺寸	Dissipation factor (tan δ) 損耗角正切	Leakage current (μA) 漏電流	ESR (mΩ) max. 20°C, 100KHz 阻抗值	Ripple current (mA rms) 105°C, 100KHz 紋波電流	Case size ∅D×L (mm) 尺寸	Dissipation factor (tan δ) 損耗角正切	Leakage current (μA) 漏電流	ESR (mΩ) max. 20°C, 100KHz 阻抗值	Ripple current (mA rms) 105°C, 100KHz 紋波電流
		100	101						6.3 × 7	0.14	25
150	151						6.3 × 7	0.14	37.5	30	2000
220	221	6.3 × 7	0.16	35.2	27	2200	6.3 × 11.5	0.14	55	27	2250
330	331	6.3 × 11.5	0.16	52.8	25	2350					
470	471						8 × 12	0.14	117.5	23	2600
680	681						10 × 12	0.14	170	15	3000
820	821	8 × 12	0.16	131.2	20	2700					
1500	152	10 × 12	0.16	240	14	3400					

WV (V)		35 (1V)					50 (1H)				
Cap. 容量 (μF)	Parameter 參數	Case size ∅D×L (mm) 尺寸	Dissipation factor (tan δ) 損耗角正切	Leakage current (μA) 漏電流	ESR (mΩ) max. 20°C, 100KHz 阻抗值	Ripple current (mA rms) 105°C, 100KHz 紋波電流	Case size ∅D×L (mm) 尺寸	Dissipation factor (tan δ) 損耗角正切	Leakage current (μA) 漏電流	ESR (mΩ) max. 20°C, 100KHz 阻抗值	Ripple current (mA rms) 105°C, 100KHz 紋波電流
		33	330						6.3 × 7	0.10	16.5
47	470						6.3 × 11.5	0.10	23.5	36	1750
100	101	6.3 × 7	0.12	35	35	2000					
120	121						8 × 12	0.10	60	28	2000
150	151	6.3 × 11.5	0.12	52.5	32	2250					
220	221	8 × 12	0.12	77	24	2500	10 × 12	0.10	110	23	2200
470	471	10 × 12	0.12	164.5	16	2900					

WV (V)		63 (1J)					80 (1K)				
Cap. 容量 (μF)	Parameter 參數	Case size ∅D×L (mm) 尺寸	Dissipation factor (tan δ) 損耗角正切	Leakage current (μA) 漏電流	ESR (mΩ) max. 20°C, 100KHz 阻抗值	Ripple current (mA rms) 105°C, 100KHz 紋波電流	Case size ∅D×L (mm) 尺寸	Dissipation factor (tan δ) 損耗角正切	Leakage current (μA) 漏電流	ESR (mΩ) max. 20°C, 100KHz 阻抗值	Ripple current (mA rms) 105°C, 100KHz 紋波電流
		22	220	6.3 × 7	0.08	13.9	80	1500			
33	330	6.3 × 11.5	0.08	20.8	70	1600					
47	470						8 × 12	0.08	37.6	42	1750
82	820						10 × 12	0.08	65.6	33	1850
100	101	8 × 12	0.08	63	36	1800					
150	151	10 × 12	0.08	94.5	26	2000					

WV (V)		100 (2A)				
Cap. 容量 (μF)	Parameter 參數	Case size ∅D×L (mm) 尺寸	Dissipation factor (tan δ) 損耗角正切	Leakage current (μA) 漏電流	ESR (mΩ) max. 20°C, 100KHz 阻抗值	Ripple current (mA rms) 105°C, 100KHz 紋波電流
		47	470	10 × 12	0.08	47

□ FREQUENCY COEFFICIENT OF ALLOWABLE RIPPLE CURRENT 紋波電流頻率補償系數

Frequency 頻率	120Hz ≤ f ≤ 1KHz	1KHz ≤ f ≤ 10KHz	10KHz ≤ f ≤ 100KHz	100KHz ≤ f ≤ 300KHz
Coefficient 系數	0.10	0.40	0.70	1.00

- Please refer to page 19, 21 about the taped or cutting product spec. 編帶與剪腳標準請查閱第 19, 21 頁。
- Please refer to page 20 for the minimum package quantity. 最小包裝數量請查閱第 20 頁。
- Please refer to page 15 for the Part Number System. 產品編碼規則請查閱第 15 頁。

Note: All design and specifications are for reference only and is subject to change without prior notice. If any doubt about safety for your application, please contact us immediately for technical assistance before purchase.

注: 以上所提供的設計及特性參數僅供參考, 任何修改不作預先通知。如果在使用上有疑問, 請在採購前與我們聯繫, 以便提供技術上的協助。

CAT.2023/V2

HPR Series

RADIAL LEAD TYPE, HIGH RELIABILITY

插件式，高可靠品



- Operating with wide temperature range -55~+125°C
適用於 -55~+125°C 的寬溫範圍
- High reliability & high voltage are realized by hybrid electrolyte
通過混合型電解質，提升高可靠性和高電壓化
- Endurance 4000 hours
耐久性 4000 小時
- RoHS & REACH compliant, Halogen-free
符合 RoHS 與 REACH，無鹵
- AEC-Q200 compliant (Please contact us for details)
符合 AEC-Q200 (請與我們聯繫瞭解詳細信息)

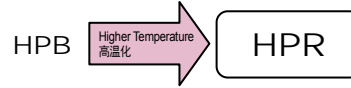

□ SPECIFICATIONS 特性表

Items 項目	Characteristics 主要特性								
Category Temperature Range 工作溫度範圍	-55 ~ +125°C								
Voltage Range 額定工作電壓範圍	16 ~ 100V								
Capacitance Range 靜電容量範圍	22 ~ 1500μF								
Capacitance Tolerance 靜電容量允許偏差	±20% at 120Hz, 20°C								
Leakage Current 漏電流	Leakage current ≤0.01CV (after 2 minutes application of rated voltage at 20°C) 漏電流 ≤0.01CV (在 20°C 環境中施加額定工作電壓 2 分鐘後) C: Nominal capacitance (μF) 標稱靜電容量, V: Rated voltage (V) 額定電壓								
Dissipation Factor (tan δ) 損耗角正切	≤Specified value at 120Hz, 20°C. ≤規範值 (在 20°C 120Hz 環境下)。								
ESR 阻抗值	≤Specified value at 100KHz, 20°C. ≤規範值 (在 20°C 100KHz 環境下)。								
Stability at Low Temperature 低溫特性	Measurement frequency 測試頻率: 100KHz <table border="1"> <tr> <td rowspan="2">Impedance Ratio 阻抗比 Z1/Z20 (max.)</td> <td>Z(-25°C)/Z(20°C)</td> <td>≤1.5</td> </tr> <tr> <td>Z(-55°C)/Z(20°C)</td> <td>≤2.0</td> </tr> </table>	Impedance Ratio 阻抗比 Z1/Z20 (max.)	Z(-25°C)/Z(20°C)	≤1.5	Z(-55°C)/Z(20°C)	≤2.0			
Impedance Ratio 阻抗比 Z1/Z20 (max.)	Z(-25°C)/Z(20°C)		≤1.5						
	Z(-55°C)/Z(20°C)	≤2.0							
Damp Heat (Steady State) 穩態濕熱	When the capacitors are restored to 20°C after the rated voltage is applied for 2000 hours at 85°C, 85% RH, they meet the characteristics listed below. 在 85°C 和相對濕度 85% 環境下施加額定工作電壓 2000 小時並冷卻至 20°C 後，電容器的特性符合下表的要求。 <table border="1"> <tr> <td>Capacitance Change 靜電容量變化率</td> <td>Within ±30% of initial value 為初始值的±30%以內</td> </tr> <tr> <td>Dissipation Factor 損耗角正切</td> <td>200% or less of initial specified value 不大於規範值的 200%</td> </tr> <tr> <td>ESR 阻抗值</td> <td>200% or less of initial specified value 不大於規範值的 200%</td> </tr> <tr> <td>Leakage Current 漏電流</td> <td>Initial specified value or less 不大於規範值</td> </tr> </table>	Capacitance Change 靜電容量變化率	Within ±30% of initial value 為初始值的±30%以內	Dissipation Factor 損耗角正切	200% or less of initial specified value 不大於規範值的 200%	ESR 阻抗值	200% or less of initial specified value 不大於規範值的 200%	Leakage Current 漏電流	Initial specified value or less 不大於規範值
Capacitance Change 靜電容量變化率	Within ±30% of initial value 為初始值的±30%以內								
Dissipation Factor 損耗角正切	200% or less of initial specified value 不大於規範值的 200%								
ESR 阻抗值	200% or less of initial specified value 不大於規範值的 200%								
Leakage Current 漏電流	Initial specified value or less 不大於規範值								
Endurance 耐久性	After 4000 hours application of the rated voltage at 125°C, they meet the characteristics listed below. 在 125°C 環境中施加額定工作電壓 4000 小時後，電容器的特性符合下表的要求。 <table border="1"> <tr> <td>Capacitance Change 靜電容量變化率</td> <td>Within ±30% of initial value 為初始值的±30%以內</td> </tr> <tr> <td>Dissipation Factor 損耗角正切</td> <td>200% or less of initial specified value 不大於規範值的 200%</td> </tr> <tr> <td>ESR 阻抗值</td> <td>200% or less of initial specified value 不大於規範值的 200%</td> </tr> <tr> <td>Leakage Current 漏電流</td> <td>Initial specified value or less 不大於規範值</td> </tr> </table>	Capacitance Change 靜電容量變化率	Within ±30% of initial value 為初始值的±30%以內	Dissipation Factor 損耗角正切	200% or less of initial specified value 不大於規範值的 200%	ESR 阻抗值	200% or less of initial specified value 不大於規範值的 200%	Leakage Current 漏電流	Initial specified value or less 不大於規範值
Capacitance Change 靜電容量變化率	Within ±30% of initial value 為初始值的±30%以內								
Dissipation Factor 損耗角正切	200% or less of initial specified value 不大於規範值的 200%								
ESR 阻抗值	200% or less of initial specified value 不大於規範值的 200%								
Leakage Current 漏電流	Initial specified value or less 不大於規範值								
Shelf Life 高溫貯存特性	After leaving capacitors under no load at 125°C for 1000 hours, they meet the specified value for Endurance characteristics listed above. 在 125°C 環境中無負荷放置 1000 小時後，電容器的特性符合耐久性中所列的規定值。								
Resistance to Soldering Heat 耐焊接熱特性 (Please refer page 9 for soldering conditions) (焊接條件請查閱第 12 頁)	After reflow soldering and restored at room temperature, they meet the characteristics listed below. 經過回流焊並冷卻至室溫後，電容器的特性符合下表的要求。 <table border="1"> <tr> <td>Capacitance Change 靜電容量變化率</td> <td>Within ±10% of initial value 初始值的±10%以內</td> </tr> <tr> <td>Dissipation Factor 損耗角正切</td> <td>130% or less of initial specified value 不大於規範值的 130%</td> </tr> <tr> <td>ESR 阻抗值</td> <td>130% or less of initial specified value 不大於規範值的 130%</td> </tr> <tr> <td>Leakage Current 漏電流</td> <td>Initial specified value or less 不大於規範值</td> </tr> </table>	Capacitance Change 靜電容量變化率	Within ±10% of initial value 初始值的±10%以內	Dissipation Factor 損耗角正切	130% or less of initial specified value 不大於規範值的 130%	ESR 阻抗值	130% or less of initial specified value 不大於規範值的 130%	Leakage Current 漏電流	Initial specified value or less 不大於規範值
Capacitance Change 靜電容量變化率	Within ±10% of initial value 初始值的±10%以內								
Dissipation Factor 損耗角正切	130% or less of initial specified value 不大於規範值的 130%								
ESR 阻抗值	130% or less of initial specified value 不大於規範值的 130%								
Leakage Current 漏電流	Initial specified value or less 不大於規範值								
Marking 標識	Red print on the case top. 鋁殼頂部紅色字體印刷。								

□ DRAWING 外形圖 (Unit: mm)

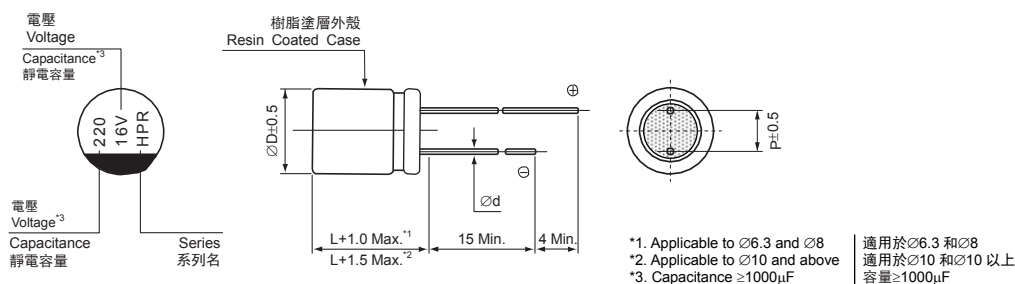

Dimension table in next page.
尺寸表見下一頁。

Note: All design and specifications are for reference only and is subject to change without prior notice. If any doubt about safety for your application, please contact us immediately for technical assistance before purchase.

注: 以上所提供的設計及特性參數僅供參考，任何修改不作預先通知。如果在使用上有疑問，請在採購前與我們聯繫，以便提供技術上的協助。

CAT.2023/V2

HPR Series

□ DIMENSIONS 尺寸表 (Unit: mm)

∅D × L	6.3 × 7	6.3 × 11.5	8 × 12	10 × 12
P	2.5	2.5	3.5	5.0
∅d	0.5	0.6	0.6	0.6
L	7.0	11.5	12.0	12.0

□ DIMENSIONS & STANDARD RATINGS 規格尺寸及標準參數

Cap. 容量 (μF)	Parameter 參數	16 (1C)					25 (1E)				
		Case size ∅D×L (mm) 尺寸	Dissipation factor (tan δ) 損耗角正切	Leakage current (μA) 漏電流	ESR (mΩ) max. 20°C, 100KHz 阻抗值	Ripple current (mA rms) 125°C, 100KHz 紋波電流	Case size ∅D×L (mm) 尺寸	Dissipation factor (tan δ) 損耗角正切	Leakage current (μA) 漏電流	ESR (mΩ) max. 20°C, 100KHz 阻抗值	Ripple current (mA rms) 125°C, 100KHz 紋波電流
100	101						6.3 × 7	0.14	25	30	1400
150	151						6.3 × 7	0.14	37.5	30	1400
220	221	6.3 × 7	0.16	35.2	27	1450	6.3 × 11.5	0.14	55	27	1650
330	331	6.3 × 11.5	0.16	52.8	25	1600					
470	471						8 × 12	0.14	117.5	23	1900
680	681						10 × 12	0.14	170	15	2700
820	821	8 × 12	0.16	131.2	20	1850					
1500	152	10 × 12	0.16	240	14	3000					

Cap. 容量 (μF)	Parameter 參數	35 (1V)					50 (1H)				
		Case size ∅D×L (mm) 尺寸	Dissipation factor (tan δ) 損耗角正切	Leakage current (μA) 漏電流	ESR (mΩ) max. 20°C, 100KHz 阻抗值	Ripple current (mA rms) 125°C, 100KHz 紋波電流	Case size ∅D×L (mm) 尺寸	Dissipation factor (tan δ) 損耗角正切	Leakage current (μA) 漏電流	ESR (mΩ) max. 20°C, 100KHz 阻抗值	Ripple current (mA rms) 125°C, 100KHz 紋波電流
33	330						6.3 × 7	0.10	16.5	40	1100
47	470						6.3 × 11.5	0.10	23.5	36	1250
100	101	6.3 × 7	0.12	35	35	1400					
120	121						8 × 12	0.10	60	28	1400
150	151	6.3 × 11.5	0.12	52.5	32	1650					
220	221	8 × 12	0.12	77	24	1800	10 × 12	0.10	110	23	1800
470	471	10 × 12	0.12	164.5	16	2600					

Cap. 容量 (μF)	Parameter 參數	63 (1J)					80 (1K)				
		Case size ∅D×L (mm) 尺寸	Dissipation factor (tan δ) 損耗角正切	Leakage current (μA) 漏電流	ESR (mΩ) max. 20°C, 100KHz 阻抗值	Ripple current (mA rms) 125°C, 100KHz 紋波電流	Case size ∅D×L (mm) 尺寸	Dissipation factor (tan δ) 損耗角正切	Leakage current (μA) 漏電流	ESR (mΩ) max. 20°C, 100KHz 阻抗值	Ripple current (mA rms) 125°C, 100KHz 紋波電流
22	220	6.3 × 7	0.08	13.9	80	900					
33	330	6.3 × 11.5	0.08	20.8	70	1000					
47	470						8 × 12	0.08	37.6	42	1200
82	820						10 × 12	0.08	65.6	33	1350
100	101	8 × 12	0.08	63	36	1300					
150	151	10 × 12	0.08	94.5	26	1600					

Cap. 容量 (μF)	Parameter 參數	100 (2A)				
		Case size ∅D×L (mm) 尺寸	Dissipation factor (tan δ) 損耗角正切	Leakage current (μA) 漏電流	ESR (mΩ) max. 20°C, 100KHz 阻抗值	Ripple current (mA rms) 125°C, 100KHz 紋波電流
47	470	10 × 12	0.08	47	60	1050

□ FREQUENCY COEFFICIENT OF ALLOWABLE RIPPLE CURRENT 紋波電流頻率補償係數

Frequency 頻率	120KHz ≤ f ≤ 1KHz	1KHz ≤ f ≤ 10KHz	10KHz ≤ f ≤ 100KHz	100KHz ≤ f ≤ 300KHz
Coefficient 係數	0.10	0.40	0.70	1.00

- Please refer to page 19, 21 about the taped or cutting product spec. 編帶與剪腳標準請查閱第 19, 21 頁。
- Please refer to page 20 for the minimum package quantity. 最小包裝數量請查閱第 20 頁。
- Please refer to page 15 for the Part Number System. 產品編碼規則請查閱第 15 頁。

Note: All design and specifications are for reference only and is subject to change without prior notice. If any doubt about safety for your application, please contact us immediately for technical assistance before purchase.

注：以上所提供的設計及特性參數僅供參考，任何修改不作預先通知。如果在使用上有疑問，請在採購前與我們聯繫，以便提供技術上的協助。

CAT.2023/V2

HPX Series New 新品

RADIAL LEAD TYPE, LONG LIFE 插件式，長壽命品

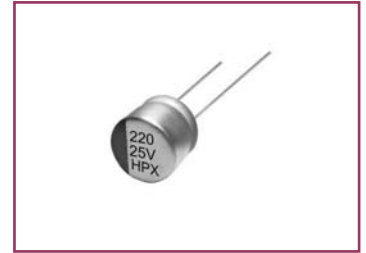

- Operating with wide temperature range -55~+105°C
適用於 -55~+105°C 的寬溫範圍
- High reliability & high voltage are realized by hybrid electrolyte
通過混合型電解質，提高可靠性和高電壓化
- Endurance 10000 hours
耐久性 10000 小時
- RoHS & REACH compliant, Halogen-free
符合 RoHS 與 REACH，無鹵
- AEC-Q200 compliant (Please contact us for details)
符合 AEC-Q200 (請與我們聯繫瞭解詳細信息)

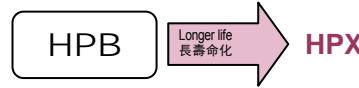

□ SPECIFICATIONS 特性表

Items 項目	Characteristics 主要特性								
Category Temperature Range 工作溫度範圍	-55 ~ +105°C								
Voltage Range 額定工作電壓範圍	25 ~ 80V								
Capacitance Range 靜電容量範圍	22 ~ 330µF								
Capacitance Tolerance 靜電容量允許偏差	±20% at 120Hz, 20°C								
Leakage Current 漏電流	Leakage current ≤0.01CV (after 2 minutes application of rated voltage at 20°C) 漏電流 ≤0.01CV (在 20°C 環境中施加額定工作電壓 2 分鐘後) C: Nominal capacitance (µF) 標稱靜電容量, V: Rated voltage (V) 額定電壓								
Dissipation Factor (tan δ) 損耗角正切	≤Specified value at 120Hz, 20°C. ≤規範值 (在 20°C 120Hz 環境下)。								
ESR 阻抗值	≤Specified value at 100KHz, 20°C. ≤規範值 (在 20°C 100KHz 環境下)。								
Stability at Low Temperature 低溫特性	Measurement frequency 測試頻率: 100KHz <table border="1" style="width: 100%;"> <tr> <td>Impedance Ratio 阻抗比</td> <td>Z(-25°C)/Z(20°C)</td> <td>≤1.5</td> </tr> <tr> <td>ZT/Z20 (max.)</td> <td>Z(-55°C)/Z(20°C)</td> <td>≤2.0</td> </tr> </table>	Impedance Ratio 阻抗比	Z(-25°C)/Z(20°C)	≤1.5	ZT/Z20 (max.)	Z(-55°C)/Z(20°C)	≤2.0		
Impedance Ratio 阻抗比	Z(-25°C)/Z(20°C)	≤1.5							
ZT/Z20 (max.)	Z(-55°C)/Z(20°C)	≤2.0							
Damp Heat (Steady State) 穩態濕熱	When the capacitors are restored to 20°C after the rated voltage is applied for 2000 hours at 85°C, 85% RH, they meet the characteristics listed below. 在 85°C 和相對濕度 85% 環境下施加額定工作電壓 2000 小時並冷卻至 20°C 後，電容器的特性符合下表的要求。 <table border="1" style="width: 100%;"> <tr> <td>Capacitance Change 靜電容量變化率</td> <td>Within ±30% of initial value 為初始值的±30%以內</td> </tr> <tr> <td>Dissipation Factor 損耗角正切</td> <td>200% or less of initial specified value 不大於規範值的 200%</td> </tr> <tr> <td>ESR 阻抗值</td> <td>200% or less of initial specified value 不大於規範值的 200%</td> </tr> <tr> <td>Leakage Current 漏電流</td> <td>Initial specified value or less 不大於規範值</td> </tr> </table>	Capacitance Change 靜電容量變化率	Within ±30% of initial value 為初始值的±30%以內	Dissipation Factor 損耗角正切	200% or less of initial specified value 不大於規範值的 200%	ESR 阻抗值	200% or less of initial specified value 不大於規範值的 200%	Leakage Current 漏電流	Initial specified value or less 不大於規範值
Capacitance Change 靜電容量變化率	Within ±30% of initial value 為初始值的±30%以內								
Dissipation Factor 損耗角正切	200% or less of initial specified value 不大於規範值的 200%								
ESR 阻抗值	200% or less of initial specified value 不大於規範值的 200%								
Leakage Current 漏電流	Initial specified value or less 不大於規範值								
Endurance 耐久性	After 10000 hours application of the rated voltage at 105°C, they meet the characteristics listed below. 在 105°C 環境中施加額定工作電壓 10000 小時後，電容器的特性符合下表的要求。 <table border="1" style="width: 100%;"> <tr> <td>Capacitance Change 靜電容量變化率</td> <td>Within ±30% of initial value 為初始值的±30%以內</td> </tr> <tr> <td>Dissipation Factor 損耗角正切</td> <td>200% or less of initial specified value 不大於規範值的 200%</td> </tr> <tr> <td>ESR 阻抗值</td> <td>200% or less of initial specified value 不大於規範值的 200%</td> </tr> <tr> <td>Leakage Current 漏電流</td> <td>Initial specified value or less 不大於規範值</td> </tr> </table>	Capacitance Change 靜電容量變化率	Within ±30% of initial value 為初始值的±30%以內	Dissipation Factor 損耗角正切	200% or less of initial specified value 不大於規範值的 200%	ESR 阻抗值	200% or less of initial specified value 不大於規範值的 200%	Leakage Current 漏電流	Initial specified value or less 不大於規範值
Capacitance Change 靜電容量變化率	Within ±30% of initial value 為初始值的±30%以內								
Dissipation Factor 損耗角正切	200% or less of initial specified value 不大於規範值的 200%								
ESR 阻抗值	200% or less of initial specified value 不大於規範值的 200%								
Leakage Current 漏電流	Initial specified value or less 不大於規範值								
Shelf Life 高溫貯存特性	After leaving capacitors under no load at 105°C for 1000 hours, they meet the specified value for Endurance characteristics listed above. 在 105°C 環境中無負荷放置 1000 小時後，電容器的特性符合耐久性中所列的規定值。								
Resistance to Soldering Heat 耐焊接熱特性 <small>(Please refer page 9 for soldering conditions) (焊接條件請查閱第 12 頁)</small>	After reflow soldering and restored at room temperature, they meet the characteristics listed below. 經過回流焊並冷卻至室溫後，電容器的特性符合下表的要求。 <table border="1" style="width: 100%;"> <tr> <td>Capacitance Change 靜電容量變化率</td> <td>Within ±10% of initial value 初始值的±10%以內</td> </tr> <tr> <td>Dissipation Factor 損耗角正切</td> <td>Initial specified value or less 不大於規範值</td> </tr> <tr> <td>ESR 阻抗值</td> <td>Initial specified value or less 不大於規範值</td> </tr> <tr> <td>Leakage Current 漏電流</td> <td>Initial specified value or less 不大於規範值</td> </tr> </table>	Capacitance Change 靜電容量變化率	Within ±10% of initial value 初始值的±10%以內	Dissipation Factor 損耗角正切	Initial specified value or less 不大於規範值	ESR 阻抗值	Initial specified value or less 不大於規範值	Leakage Current 漏電流	Initial specified value or less 不大於規範值
Capacitance Change 靜電容量變化率	Within ±10% of initial value 初始值的±10%以內								
Dissipation Factor 損耗角正切	Initial specified value or less 不大於規範值								
ESR 阻抗值	Initial specified value or less 不大於規範值								
Leakage Current 漏電流	Initial specified value or less 不大於規範值								
Marking 標識	Red print on the case top. 鋁殼頂部紅色字體印刷。								

□ DRAWING 外形圖 (Unit: mm)

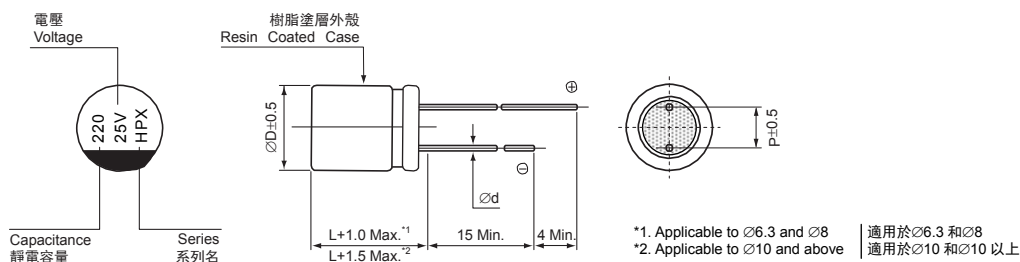

Dimension table in next page.
尺寸表見下一頁。

Note: All design and specifications are for reference only and is subject to change without prior notice. If any doubt about safety for your application, please contact us immediately for technical assistance before purchase.

注: 以上所提供的設計及特性參數僅供參考，任何修改不作預先通知。如果在使用上有疑問，請在採購前與我們聯繫，以便提供技術上的協助。

CAT.2023/V2

HPX Series

New
新品

□ DIMENSIONS 尺寸表 (Unit: mm)

∅D × L	8 × 10.5	10 × 10.5
P	3.5	5.0
∅d	0.6	0.6
L	10.5	10.5

□ DIMENSIONS & STANDARD RATINGS 規格尺寸及標準參數

Cap. 容量 (μF)	Parameter 參數	WV (V)	25 (1E)				35 (1V)					
			Case size ∅D×L (mm) 尺寸	Dissipation factor (tan δ) 損耗角正切	Leakage current (μA) 漏電流	ESR (mΩ) max. 20°C, 100KHz 阻抗值	Ripple current (mA rms) 105°C, 100KHz 紋波電流	Case size ∅D×L (mm) 尺寸	Dissipation factor (tan δ) 損耗角正切	Leakage current (μA) 漏電流	ESR (mΩ) max. 20°C, 100KHz 阻抗值	Ripple current (mA rms) 105°C, 100KHz 紋波電流
100	101						8 × 10.5	0.12	35	27	2300	
150	151		8 × 10.5	0.14	37.5	27	2300	8 × 10.5	0.12	52.5	27	2300
220	221		8 × 10.5	0.14	55	27	2300	10 × 10.5	0.12	77	20	2500
270	271							10 × 10.5	0.12	94.5	20	2500
330	331		10 × 10.5	0.14	82.5	20	2500					

Cap. 容量 (μF)	Parameter 參數	WV (V)	50 (1H)				63 (1J)					
			Case size ∅D×L (mm) 尺寸	Dissipation factor (tan δ) 損耗角正切	Leakage current (μA) 漏電流	ESR (mΩ) max. 20°C, 100KHz 阻抗值	Ripple current (mA rms) 105°C, 100KHz 紋波電流	Case size ∅D×L (mm) 尺寸	Dissipation factor (tan δ) 損耗角正切	Leakage current (μA) 漏電流	ESR (mΩ) max. 20°C, 100KHz 阻抗值	Ripple current (mA rms) 105°C, 100KHz 紋波電流
33	330						8 × 10.5	0.08	20.79	40	1700	
47	470		8 × 10.5	0.10	23.5	30	1800	8 × 10.5	0.08	29.61	40	1700
56	560							10 × 10.5	0.08	35.28	30	1800
68	680		8 × 10.5	0.10	34	30	1800	10 × 10.5	0.08	42.84	30	1800
82	820							10 × 10.5	0.08	51.66	30	1800
100	101		10 × 10.5	0.10	50	28	2000					

Cap. 容量 (μF)	Parameter 參數	WV (V)	80 (1K)				
			Case size ∅D×L (mm) 尺寸	Dissipation factor (tan δ) 損耗角正切	Leakage current (μA) 漏電流	ESR (mΩ) max. 20°C, 100KHz 阻抗值	Ripple current (mA rms) 105°C, 100KHz 紋波電流
22	220		8 × 10.5	0.08	17.6	45	1550
33	330		10 × 10.5	0.08	26.4	36	1700
47	470		10 × 10.5	0.08	37.6	36	1700

□ FREQUENCY COEFFICIENT OF ALLOWABLE RIPPLE CURRENT 紋波電流頻率補償系數

Frequency 頻率	120Hz ≤ f ≤ 1KHz	1KHz ≤ f ≤ 10KHz	10KHz ≤ f ≤ 100KHz	100KHz ≤ f ≤ 300KHz
Coefficient 系數	0.10	0.40	0.70	1.00

- Please refer to page 14 about the taped or cutting product spec. 編帶與剪腳標準請查閱第 14 頁。
- Please refer to page 13 for the minimum package quantity. 最小包裝數量請查閱第 13 頁。
- Please refer to page 11 for the Part Number System. 產品編碼規則請查閱第 11 頁。

Note: All design and specifications are for reference only and is subject to change without prior notice. If any doubt about safety for your application, please contact us immediately for technical assistance before purchase.

注：以上所提供的設計及特性參數僅供參考，任何修改不作預先通知。如果在使用上有疑問，請在採購前與我們聯繫，以便提供技術上的協助。

CAT.2023/V2

Aluminum Electrolytic Capacitors (Chip Type)
鋁電解電容器 (貼片式)



Note: All design and specifications are for reference only and is subject to change without prior notice. If any doubt about safety for your application, please contact us immediately for technical assistance before purchase.

注：以上所提供的設計及特性參數僅供參考，任何修改不作預先通知。如果在使用上有疑問，請在採購前與我們聯繫，以便提供技術上的協助。

CAT.2023/V/2

CS Series

CHIP TYPE, STANDARD

貼片式, 標準品

- Operating with general temperature range -55~+85°C
適用於 -55~+85°C 的常規溫度範圍
- Endurance 2000 hours
耐久性 2000 小時
- RoHS & REACH compliant, Halogen-free
符合 RoHS 與 REACH, 無鹵

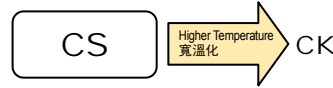

□ SPECIFICATIONS 特性表

Items 項目	Characteristics 主要特性		
Category Temperature Range 工作溫度範圍	-55 ~ +85°C	-40 ~ +85°C	-25 ~ +85°C
Voltage Range 額定工作電壓範圍	4 ~ 100V	160 ~ 400V	450V
Capacitance Range 靜電容量範圍	0.1 ~ 10000µF	3.3 ~ 100µF	3.3 ~ 33µF
Capacitance Tolerance 靜電容量允許偏差	±20% at 120Hz, 20°C		
Leakage Current 漏電流	Rated Voltage 額定工作電壓	6.3 ~ 100V	
	Case size 尺寸	Ø4~Ø10	Ø12.5~Ø18
	Time 時間	After 2 min. application of rated voltage at 20°C 在 20°C 環境中施加額定工作電壓 2 分鐘後	After 1 min. application of rated voltage at 20°C 在 20°C 環境中施加額定工作電壓 1 分鐘後
	Leakage current 漏電流	≤0.01CV or 3µA, whichever is greater ≤0.01CV 或 3µA, 取較大值	≤0.03CV or 4µA, whichever is greater ≤0.03CV 或 4µA, 取較大值
Dissipation Factor (tan δ) 損耗角正切	Measurement frequency 測試頻率: 120Hz, Temperature 溫度: 20°C		
	Rated Voltage (V) 額定工作電壓	4	6.3 10 16 25 35 50 63 100 160~250 350~450
Stability at Low Temperature 低溫特性	Measurement frequency 測試頻率: 120Hz		
	Rated Voltage (V) 額定工作電壓	4	6.3 10 16 25 35 50 63 100 160~250 350~450
	Impedance Ratio 阻抗比	Ø4~Ø10	Z(-25°C)/Z(20°C) 7 4 3 2 2 2 2 2 2 2 3
	ZT/Z20 (max.)	Ø12.5~Ø18	Z(-25°C)/Z(20°C) 15 8 6 4 4 4 3 3 3 3 6
Endurance 耐久性	After 2000 hours application of the rated voltage at 85°C, they meet the characteristics listed below. 在 85°C 環境中施加額定工作電壓 2000 小時後, 電容器的特性符合下表的要求。		
	Capacitance Change 靜電容量變化率	Within ±20% of initial value (Within ±30% of initial value for 4V) 初始值的±20%以內 (4V 為±30%以內)	
	Dissipation Factor 損耗角正切	200% or less of initial specified value 不大於規範值的 200%	
Shelf Life 高溫貯存特性	After leaving capacitors under no load at 85°C for 1000 hours, they meet the specified value for load life characteristics listed above. 在 85°C 環境中無負荷放置 1000 小時後, 電容器的特性符合高溫負荷特性中所列的規定值。		
	Resistance to Soldering Heat 耐焊接熱特性	After reflow soldering and restored at room temperature, they meet the characteristics listed below. 經過回流焊並冷卻至室溫後, 電容器的特性符合下表的要求。	
Marking 標識	Capacitance Change 靜電容量變化率	Within ±10% of initial value 初始值的±10%以內	
	Dissipation Factor 損耗角正切	initial specified value or less 不大於規範值	
	Leakage Current 漏電流	initial specified value or less 不大於規範值	

□ DRAWING 外形圖 (Unit: mm)

(Ø4~Ø6.3×7.7)

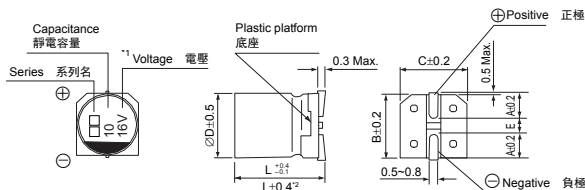

(Ø8~Ø10.5~Ø18)

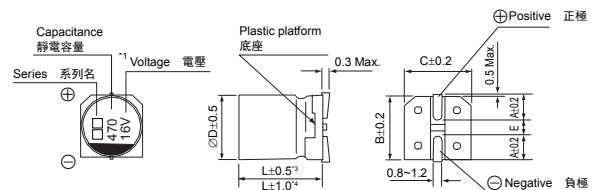

*1. Voltage mark for 6.3V is [6V]
 *2. Applicable to Ø6.3×7.7
 *3. Applicable to Ø8×10.5~Ø10
 *4. Applicable to Ø12.5~Ø18

6.3V 的產品標識為 [6V]
 適用於 Ø6.3×7.7
 適用於 Ø8×10.5~Ø10
 適用於 Ø12.5~Ø18

Dimension table in next page.
尺寸表見下一頁。

Note: All design and specifications are for reference only and is subject to change without prior notice. If any doubt about safety for your application, please contact us immediately for technical assistance before purchase.

注: 以上所提供的設計及特性參數僅供參考, 任何修改不作預先通知。如果在使用上有疑問, 請在採購前與我們聯繫, 以便提供技術上的協助。

CS Series

□ DIMENSIONS (Unit: mm) 尺寸表

∅D x L	4 x 5.4	5 x 5.4	6.3 x 5.4/7.7	8 x 10.5	10 x 10.5/13.5	12.5 x 13.5/16	16 x 16.5	18 x 16.5/18.5
A	2.0	2.2	2.6	3.0	3.3	4.9	5.8	6.2
B	4.3	5.3	6.6	8.4	10.4	13.0	17.0	19.0
C	4.3	5.3	6.6	8.4	10.4	13.0	17.0	19.0
E ± 0.2	1.0	1.4	1.9	3.1	4.7	4.7	6.4	6.4
L	5.4	5.4	5.4/7.7	10.5	10.5/13.5	13.5/16	16.5	16.5/18.5

□ DIMENSIONS & MAXIMUM PERMISSIBLE RIPPLE CURRENT 規格尺寸及最大允許紋波電流

μF	WV Code 代碼	4		6.3		10		16		25	
		0G		0J		1A		1C		1E	
4.7	4R7									4 x 5.4	19
10	100							4 x 5.4	25	5 x 5.4 (4 x 5.4)	28 (20)
15	150							4 x 5.4	28	5 x 5.4	34
22	220			4 x 5.4	31	5 x 5.4 (4 x 5.4)	35 (28)	5 x 5.4 (4 x 5.4)	39 (28)	6.3 x 5.4 (5 x 5.4)	52 (35)
33	330	4 x 5.4	26	5 x 5.4 (4 x 5.4)	39 (31)	5 x 5.4 (4 x 5.4)	43 (32)	6.3 x 5.4 (5 x 5.4)	57 (40)	6.3 x 5.4 (5 x 5.4)	63 (42)
47	470	4 x 5.4	34	5 x 5.4 (4 x 5.4)	47 (36)	5 x 5.4	43	6.3 x 5.4 (5 x 5.4)	68 (44)	6.3 x 5.4	68
56	560	4 x 5.4	39	5 x 5.4	46	6.3 x 5.4	57	6.3 x 5.4	74	6.3 x 5.4	82
68	680	5 x 5.4	45	6.3 x 5.4 (5 x 5.4)	62 (52)	6.3 x 5.4	72	6.3 x 5.4	80	6.3 x 5.4	94
100	101	5 x 5.4	61	6.3 x 5.4 (5 x 5.4)	71 (55)	6.3 x 5.4 (5 x 5.4)	76 (70)	6.3 x 5.4	86	6.3 x 7.7	130
150	151	6.3 x 5.4	74	6.3 x 5.4	78	6.3 x 5.4	88	6.3 x 7.7	135	8 x 10.5 (6.3 x 7.7)	200 (130)
220	221	6.3 x 5.4	82	6.3 x 5.4	95	6.3 x 7.7	150	8 x 10.5 (6.3 x 7.7)	215 (150)	8 x 10.5	250
330	331	6.3 x 7.7	150	6.3 x 7.7	150	8 x 10.5	280	8 x 10.5	280	10 x 10.5 (8 x 10.5)	340 (310)
470	471	6.3 x 7.7	150	8 x 10.5 (6.3 x 7.7)	300 (150)	10 x 10.5 (8 x 10.5)	320 (300)	10 x 10.5 (8 x 10.5)	420 (330)	10 x 10.5	400
680	681	8 x 10.5	300	8 x 10.5	300	10 x 10.5	380	10 x 10.5	450	10 x 13.5	550
1000	102	8 x 10.5	330	10 x 10.5 (8 x 10.5)	430 (330)	10 x 10.5	450	12.5 x 13.5 (10 x 13.5) (10 x 10.5)	710 (550) (490)	12.5 x 13.5	820
1500	152	10 x 10.5	450	10 x 13.5 (10 x 10.5)	650 (450)	10 x 13.5	650	12.5 x 13.5	750	12.5 x 16	1000
2200	222	10 x 13.5 (10 x 10.5)	620 (480)	12.5 x 13.5 (10 x 13.5)	890 (720)	12.5 x 13.5	960	16 x 16.5 (12.5 x 16)	1150 (1000)	16 x 16.5	1250
3300	332	10 x 13.5	700	12.5 x 16 (12.5 x 13.5)	1000 (900)	16 x 16.5 (12.5 x 16)	1300 (1050)	16 x 16.5	1350	18 x 16.5	1450
4700	472	12.5 x 13.5	850	16 x 16.5	1400	16 x 16.5	1450	18 x 16.5	1600	18 x 18.5	1750
6800	682	16 x 16.5 (12.5 x 16)	1350 (900)	18 x 16.5	1700	18 x 16.5	1700	18 x 18.5	2000	Case size 尺寸	Ripple current 紋波電流
10000	103			18 x 18.5	2000	18 x 18.5	2000				

μF	WV Code 代碼	35		50		63		100	
		1V		1H		1J		2A	
0.1	0R1			4 x 5.4	1.0	4 x 5.4	1.0		
0.22	R22			4 x 5.4	2.3	4 x 5.4	2.3		
0.33	R33			4 x 5.4	3.5	4 x 5.4	3.5		
0.47	R47			4 x 5.4	5.0	4 x 5.4	5.0		
1	010			4 x 5.4	10	4 x 5.4	10	4 x 5.4	10
1.5	1R5			4 x 5.4	12	4 x 5.4	12	6.3 x 5.4	15
2.2	2R2			4 x 5.4	15	4 x 5.4	15	6.3 x 5.4	20
3.3	3R3	4 x 5.4	18	4 x 5.4	18	5 x 5.4	20	6.3 x 7.7 (6.3 x 5.4)	45 (28)
4.7	4R7	4 x 5.4	20	5 x 5.4 (4 x 5.4)	23 (19)	5 x 5.4	23	6.3 x 7.7 (6.3 x 5.4)	50 (30)
10	100	5 x 5.4 (4 x 5.4)	30 (20)	6.3 x 5.4 (5 x 5.4)	34 (27)	6.3 x 7.7 (6.3 x 5.4)	55 (34)	8 x 10.5 (6.3 x 7.7)	110 (50)
22	220	6.3 x 5.4 (5 x 5.4)	54 (42)	6.3 x 5.4	60	8 x 10.5 (6.3 x 7.7)	140 (70)	10 x 10.5 (8 x 10.5)	180 (120)
33	330	6.3 x 5.4	60	6.3 x 7.7	85	8 x 10.5 (6.3 x 7.7)	160 (85)	10 x 10.5	190
47	470	6.3 x 5.4 (6.3 x 7.7)	70 (165)	10 x 10.5 (8 x 10.5) (6.3 x 7.7)	130 (110) (90)	10 x 10.5 (8 x 10.5)	230 (170)	Case size 尺寸	Ripple current 紋波電流

•Case size ∅D×L(mm), ripple current (mA rms) at 85°C, 120Hz •尺寸∅D×L(mm), 紋波電流(mA rms)於 85°C, 120Hz

Note: All design and specifications are for reference only and is subject to change without prior notice. If any doubt about safety for your application, please contact us immediately for technical assistance before purchase.

注：以上所提供的設計及特性參數僅供參考，任何修改不作預先通知。如果在使用上有疑問，請在採購前與我們聯繫，以便提供技術上的協助。

CAT.2023/V2

CS Series

□ DIMENSIONS & MAXIMUM PERMISSIBLE RIPPLE CURRENT 規格尺寸及最大允許紋波電流

WV Code μF 代碼	35		50		63		100		160		
	1V		1H		1J		2A		2C		
22 220										10 × 13.5	100
33 330										12.5 × 13.5	290
47 470								10 × 10.5	240	12.5 × 13.5 (16 × 16.5)	300 (370)
56 560	6.3 × 7.7	80	6.3 × 7.7	110	10 × 10.5	250				12.5 × 16	390
68 680	6.3 × 7.7	110	8 × 10.5	170	10 × 10.5	260				16 × 16.5	500
100 101	8 × 10.5 (6.3 × 7.7)	175 (120)	10 × 10.5 (8 × 10.5)	240 (200)	12.5 × 13.5 (10 × 13.5) (10 × 10.5)	380 (290) (280)	12.5 × 13.5	440		16 × 16.5 (18 × 16.5)	650 (690)
150 151	8 × 10.5	220	10 × 10.5	240	10 × 13.5	310	12.5 × 13.5	540			
220 221	10 × 10.5 (8 × 10.5)	310 (270)	10 × 13.5 (10 × 10.5)	400 (320)	12.5 × 13.5	580	16 × 16.5	700			
330 331	10 × 10.5	350	12.5 × 13.5 (10 × 13.5)	600 (420)	16 × 16.5 (12.5 × 16)	820 (720)	18 × 16.5	780			
470 471	12.5 × 13.5 (10 × 13.5) (10 × 10.5)	600 (530) (400)	16 × 16.5 (12.5 × 16)	850 (740)	16 × 16.5	950					
680 681	12.5 × 13.5	750	16 × 16.5	950	18 × 16.5	1100					
1000 102	16 × 16.5 (12.5 × 16)	1100 (800)	18 × 16.5	1350							
2200 222	18 × 16.5	1450								Case size 尺寸	Ripple current 紋波電流
3300 333	18 × 18.5	1750									

WV Code μF 代碼	200		250		350		400		450		
	2D		2E		2V		2G		2W		
3.3 3R3							10 × 13.5	80	10 × 13.5	80	
4.7 4R7						10 × 13.5	115	10 × 13.5 (12.5 × 13.5)	100 (120)	10 × 13.5 (12.5 × 13.5)	100 (120)
10 100	10 × 13.5	135	10 × 13.5	135	12.5 × 13.5	120	12.5 × 13.5	120	12.5 × 13.5 (12.5 × 16)	120 (130)	
22 220	12.5 × 13.5	240	12.5 × 13.5	150	16 × 16.5	140	16 × 16.5	140	16 × 16.5	140	
33 330	12.5 × 13.5	300	12.5 × 16 (16 × 16.5)	240 (300)	16 × 16.5	140	16 × 16.5	140	18 × 16.5	180	
47 470	16 × 16.5	420	16 × 16.5	340	18 × 16.5	280	18 × 16.5	280	Case size 尺寸	Ripple current 紋波電流	
100 101	16 × 16.5	420	18 × 16.5	440	18 × 18.5	350	18 × 18.5	350			

• Case size $\varnothing D \times L$ (mm), ripple current (mA rms) at 85°C, 120Hz • 尺寸 $\varnothing D \times L$ (mm), 紋波電流 (mA rms) 於 85°C, 120Hz

□ FREQUENCY COEFFICIENT OF ALLOWABLE RIPPLE CURRENT 紋波電流頻率補償系數

Frequency 頻率		50Hz	120Hz	300Hz	1KHz	10KHz~	
Coefficient 系數	Ø4 ~ Ø10	0.1 ~ 68μF	0.70	1.00	1.17	1.36	1.50
		100 ~ 3300μF	0.85	1.00	1.08	1.20	1.30
	Ø12.5 ~ Ø18	~ 68μF	0.75	1.00	1.35	1.57	2.00
		100 ~ 680μF	0.80	1.00	1.23	1.34	1.50
		1000 ~ 6800μF	0.85	1.00	1.10	1.13	1.15

The endurance of capacitors is reduced with internal heating produced by ripple current at the rate of halving the lifetime with every 5~10°C rise. When long life performance is required in actual use, the rms ripple current has to be reduced. 鋁電解電容器在疊加紋波電流後會引起發熱，溫度每上升 5~10°C 壽命會減半。若要保持長壽命性能，請在使用過程中適當降低紋波電流。

- Taping specifications are given in page 17. 編帶標準請查閱第 17 頁。
- Soldering conditions and recommended land size are given in page 23. 焊接條件及推薦安裝尺寸請查閱第 23 頁。
- Please refer to page 18 for the minimum package quantity. 最小包裝數量請查閱第 18 頁。
- Please refer to page 15 for the Part Number System. 產品編碼規則請查閱第 15 頁。

Note: All design and specifications are for reference only and is subject to change without prior notice. If any doubt about safety for your application, please contact us immediately for technical assistance before purchase.

注：以上所提供的設計及特性參數僅供參考，任何修改不作預先通知。如果在使用上有疑問，請在採購前與我們聯繫，以便提供技術上的協助。

CAT.2023/V2

CK Series

CHIP TYPE, WIDE TEMPERATURE

貼片式，寬溫品



- Operating with wide temperature range -55~+105°C
適用於 -55~+105°C 的寬溫範圍
- Endurance 2000 hours
耐久性 2000 小時
- RoHS & REACH compliant, Halogen-free
符合 RoHS 與 REACH，無鹵

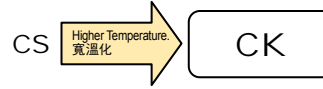

□ SPECIFICATIONS 特性表

Items 項目	Characteristics 主要特性													
Category 工作溫度範圍	-55 ~ +105°C	-40 ~ +105°C	-25 ~ +105°C											
Voltage Range 額定工作電壓範圍	4 ~ 100V	160 ~ 400V	450V											
Capacitance Range 靜電容量範圍	0.1 ~ 8200µF	3.3 ~ 100µF	3.3 ~ 33µF											
Capacitance Tolerance 靜電容量允許偏差	±20% at 120Hz, 20°C													
Leakage Current 漏電流	Rated Voltage 額定工作電壓	6.3 ~ 100V												
	Case size 尺寸	∅4~∅10	∅12.5~∅18											
	Time 時間	After 2 min. application of rated voltage at 20°C 在 20°C 環境中施加額定工作電壓 2 分鐘後	After 1 min. application of rated voltage at 20°C 在 20°C 環境中施加額定工作電壓 1 分鐘後											
	Leakage current 漏電流	≤0.01CV or 3µA, whichever is greater ≤0.01CV 或 3µA, 取較大值	≤0.03CV or 4µA, whichever is greater ≤0.03CV 或 4µA, 取較大值											
Dissipation Factor (tan δ) 損耗角正切	Rated Voltage (V) 額定工作電壓	4	6.3	10	16	25	35	50	63	100	160~250	350~450		
	tan δ (max.) 最大損耗角正切	∅4~∅10	0.42	0.30	0.26	0.22	0.16	0.14	0.12	0.10	0.10	0.20	0.25	
Stability at Low Temperature 低溫特性	Measurement frequency 測試頻率: 120Hz, Temperature 溫度: 20°C													
	Rated Voltage (V) 額定工作電壓													
	Impedance Ratio 阻抗比	∅4~∅10	Z(-25°C)/Z(20°C)	7	4	3	2	2	2	2	3	4	3	3
			Z(-55°C)/Z(20°C)	15	8	6	4	4	3	3	4	3	6	6
ZT/Z20 (max.)	∅12.5~∅18	Z(-25°C)/Z(20°C)	7	5	4	3	2	2	2	2	2	4	4	
		Z(-55°C)/Z(20°C)	17	12	10	8	5	4	3	3	6	10	10	
Endurance 耐久性	After 2000 hours application of the rated voltage at 105°C, they meet the characteristics listed below. 在 105°C 環境中施加額定工作電壓 2000 小時後，電容器的特性符合下表的要求。													
	Capacitance Change 靜電容量變化率	Within ±20% of initial value for capacitors of 10V or more (Within ±30% of initial value for capacitors of 4V or less) ≥10V 為初始值的±20%以內 (≤4V 為初始值的±30%以內)												
	Dissipation Factor 損耗角正切	200% or less of initial specified value 不大於規範值的 200%												
Shelf Life 高溫貯存特性	After leaving capacitors under no load at 105°C for 1000 hours, they meet the specified value for load life characteristics listed above. 在 105°C 環境中無負荷放置 1000 小時後，電容器的特性符合高溫負荷特性中所列的規定值。													
	Resistance to Soldering Heat 耐焊接熱特性 (Please refer page 23 for soldering conditions) (焊接條件請查閱第 23 頁)	After reflow soldering and restored at room temperature, they meet the characteristics listed below. 經過回流焊並冷卻至室溫後，電容器的特性符合下表的要求。												
Capacitance Change 靜電容量變化率		Within ±10% of initial value 初始值的±10%以內												
Dissipation Factor 損耗角正切		initial specified value or less 不大於規範值												
Marking 標識	Black print on the case top. 鋁殼頂部黑字印刷。													

□ DRAWING 外形圖 (Unit: mm)

(∅4~∅6.3×7.7)

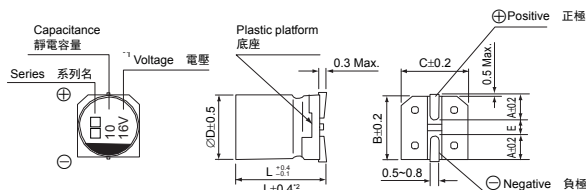

(∅8×10.5~∅18)

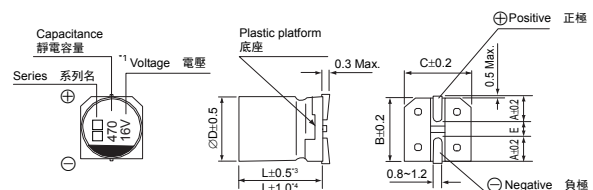

- *1. Voltage mark for 6.3V is [6V]
- *2. Applicable to ∅6.3×7.7
- *3. Applicable to ∅8×10.5~∅10
- *4. Applicable to ∅12.5~∅18

- 6.3V 的產品標識為 [6V]
- 適用於 ∅6.3×7.7
- 適用於 ∅8×10.5~∅10
- 適用於 ∅12.5~∅18

Dimension table in next page.
尺寸表見下一頁。

Note: All design and specifications are for reference only and is subject to change without prior notice. If any doubt about safety for your application, please contact us immediately for technical assistance before purchase.

注: 以上所提供的設計及特性參數僅供參考，任何修改不作預先通知。如果在使用上有疑問，請在採購前與我們聯繫，以便提供技術上的協助。

CAT.2023/V2

CK Series

□ DIMENSIONS (Unit: mm) 尺寸表

∅D x L	4 x 5.4	5 x 5.4	6.3 x 5.4/7.7	8 x 6.2/10.5	10 x 10.5/12.5/13.5	12.5 x 13.5/16	16 x 16.5	18 x 16.5/18.5
A	2.0	2.2	2.6	3.3/3.0	3.3	4.9	5.8	6.2
B	4.3	5.3	6.6	8.4	10.4	13.0	17.0	19.0
C	4.3	5.3	6.6	8.4	10.4	13.0	17.0	19.0
E ± 0.2	1.0	1.4	1.9	2.3/3.1	4.7	4.7	6.4	6.4
L	5.4	5.4	5.4/7.7	6.2/10.5	10.5/12.5/13.5	13.5/16	16.5	16.5/18.5

□ DIMENSIONS & MAXIMUM PERMISSIBLE RIPPLE CURRENT 規格尺寸及最大允許紋波電流

WV Code 代碼	μF	4		6.3		10		16		25	
		0G		0J		1A		1C		1E	
4.7	4R7							4 x 5.4	13	4 x 5.4	17
10	100							4 x 5.4	20	5 x 5.4 (4 x 5.4)	23 (20)
22	220	4 x 5.4	20	4 x 5.4	23	5 x 5.4 (4 x 5.4)	29 (22)	5 x 5.4 (4 x 5.4)	32 (25)	6.3 x 5.4 (5 x 5.4)	39 (32)
33	330	5 x 5.4 (4 x 5.4)	30 (25)	5 x 5.4 (4 x 5.4)	34 (30)	5 x 5.4 (4 x 5.4)	35 (30)	6.3 x 5.4 (5 x 5.4)	45 (35)	6.3 x 5.4 (5 x 5.4)	48 (35)
47	470	5 x 5.4 (4 x 5.4)	36 (30)	5 x 5.4 (4 x 5.4)	38 (35)	5 x 5.4	38	6.3 x 5.4 (5 x 5.4)	55 (40)	6.3 x 5.4	60
100	101	6.3 x 5.4 (5 x 5.4)	64 (54)	6.3 x 5.4 (5 x 5.4)	69 (59)	6.3 x 5.4 (5 x 5.4)	80 (60)	6.3 x 5.4	80	6.3 x 7.7 (6.3 x 5.4) (8 x 6.2)	100 (80) (130)
150	151	6.3 x 5.4	80	6.3 x 5.4	85	6.3 x 5.4	85	6.3 x 7.7	105	8 x 10.5 (6.3 x 7.7)	240 (120)
220	221	6.3 x 5.4	90	6.3 x 7.7 (6.3 x 5.4)	120 (95)	6.3 x 7.7 (6.3 x 5.4)	120 (95)	8 x 10.5 (6.3 x 7.7)	270 (120)	8 x 10.5	270
330	331	6.3 x 7.7	120	6.3 x 7.7	120	8 x 10.5 (6.3 x 7.7)	290 (135)	8 x 10.5	290	10 x 10.5 (8 x 10.5)	380 (290)
470	471	6.3 x 7.7	120	8 x 10.5 (6.3 x 7.7)	320 (120)	10 x 10.5 (8 x 10.5)	380 (320)	10 x 10.5 (8 x 10.5)	380 (290)	10 x 10.5	380
680	681	8 x 10.5	320	8 x 10.5	350	10 x 10.5 (8 x 10.5)	380 (350)	10 x 10.5	380	10 x 13.5	400
1000	102	8 x 10.5	320	10 x 10.5 (8 x 10.5)	410 (350)	10 x 10.5	410	12.5 x 13.5 (10 x 13.5) (10 x 10.5)	550 (460) (410)	12.5 x 13.5	580
1500	152	10 x 10.5	410	10 x 13.5 (10 x 10.5)	450 (410)	10 x 13.5	460	12.5 x 13.5	550	12.5 x 16	850
2200	222	10 x 13.5 (10 x 10.5)	440 (410)	12.5 x 13.5 (10 x 13.5)	680 (560)	12.5 x 13.5	680	16 x 16.5 (12.5 x 16)	900 (750)	16 x 16.5	1050
3300	332	10 x 13.5	490	12.5 x 16 (12.5 x 13.5)	850 (810)	16 x 16.5	1000	16 x 16.5	1000	18 x 16.5	1150
4700	472	12.5 x 13.5	600	16 x 16.5	1000	16 x 16.5	1000	18 x 16.5	1225	18 x 18.5	1300
6800	682	16 x 16.5 (12.5 x 16)	950 (650)	18 x 16.5	1290	18 x 16.5	1290			Case size 尺寸	Ripple current 紋波電流
8200	822			18 x 18.5	1450	18 x 18.5	1450				

WV Code 代碼	μF	35		50		63		100	
		1V		1H		1J		2A	
0.1	0R1			4 x 5.4	2	4 x 5.4	2		
0.22	R22			4 x 5.4	4	4 x 5.4	4		
0.33	R33			4 x 5.4	4	4 x 5.4	4		
0.47	R47			4 x 5.4	5	4 x 5.4	5		
1	010			4 x 5.4	8	4 x 5.4	8	4 x 5.4	8
2.2	2R2			4 x 5.4	12	4 x 5.4	12	6.3 x 5.4 (5 x 5.4)	14 (12)
3.3	3R3	4 x 5.4	13	4 x 5.4	14	5 x 5.4	17	6.3 x 7.7 (6.3 x 5.4)	55 (20)
4.7	4R7	4 x 5.4	17	5 x 5.4 (4 x 5.4)	20 (14)	5 x 5.4	20	6.3 x 7.7 (6.3 x 5.4)	50 (21)
10	100	5 x 5.4 (4 x 5.4)	27 (18)	6.3 x 5.4 (5 x 5.4)	32 (27)	6.3 x 7.7 (6.3 x 5.4)	58 (32)	8 x 10.5 (8 x 6.2) (6.3 x 7.7)	77 (55) (58)
22	220	6.3 x 5.4 (5 x 5.4)	44 (36)	6.3 x 7.7 (6.3 x 5.4)	58 (44)	8 x 10.5 (6.3 x 7.7)	100 (58)	10 x 10.5 (8 x 10.5)	126 (100)
33	330	6.3 x 5.4	50	6.3 x 7.7	65	8 x 10.5	140	10 x 10.5	150
47	470	6.3 x 7.7 (6.3 x 5.4)	80 (58)	8 x 10.5 (6.3 x 7.7)	170 (70)	10 x 10.5 (8 x 10.5)	160 (170)	12.5 x 13.5 (10 x 13.5) (10 x 10.5)	250 (180) (160)
68	680					Case size 尺寸	Ripple current 紋波電流	12.5 x 13.5 (10 x 13.5)	300 (180)

•Case size ∅D×L(mm), ripple current (mA rms) at 105°C, 120Hz •尺寸∅D×L(mm), 紋波電流(mA rms)於105°C, 120Hz

Note: All design and specifications are for reference only and is subject to change without prior notice. If any doubt about safety for your application, please contact us immediately for technical assistance before purchase.

注：以上所提供的設計及特性參數僅供參考，任何修改不作預先通知。如果在使用上有疑問，請在採購前與我們聯繫，以便提供技術上的協助。

CAT.2023/V2

CK Series

DIMENSIONS & MAXIMUM PERMISSIBLE RIPPLE CURRENT 規格尺寸及最大允許紋波電流

WV Code 代碼	μF	35		50		63		100		160	
		1V		1H		1J		2A		2C	
22	220									10 × 13.5	50
33	330									12.5 × 13.5	95
47	470							10 × 10.5	160	12.5 × 13.5 (16 × 16.5)	205 (240)
100	101	8 × 10.5 (6.3 × 7.7)	240 (92)	10 × 10.5 (8 × 10.5)	250 (210)	12.5 × 13.5 (10 × 13.5) (10 × 10.5)	400 (350) (310)	16 × 16.5 (12.5 × 13.5)	450 (380)	16 × 16.5	250
150	151	8 × 10.5	240	10 × 10.5	300	10 × 13.5	350				
220	221	10 × 10.5 (8 × 10.5)	270 (250)	10 × 13.5 (10 × 10.5)	330 (280)	16 × 16.5 (12.5 × 13.5)	560 (470)	16 × 16.5	550		
330	331	10 × 10.5	370	16 × 16.5 (12.5 × 13.5) (10 × 13.5)	600 (490) (295)	16 × 16.5 (12.5 × 16)	700 (510)	18 × 16.5	590		
470	471	12.5 × 13.5 (10 × 13.5) (10 × 10.5)	520 (400) (370)	16 × 16.5 (12.5 × 16) (12.5 × 13.5)	700 (550) (470)	16 × 16.5	750	18 × 18.5	980		
680	681	12.5 × 13.5	530	16 × 16.5	750	18 × 16.5	790				
1000	102	16 × 16.5 (12.5 × 16)	800 (600)	18 × 16.5	990						
1500	152	16 × 16.5	750							Case size 尺寸	Ripple current 紋波電流
2200	222	18 × 16.5	1050								

WV Code 代碼	μF	200		250		350		400		450	
		2D		2E		2V		2G		2W	
3.3	3R3							10 × 13.5 (8 × 10.5)	40 (35)	10 × 13.5 (8 × 12.5)	40 (38)
4.7	4R7			10 × 13.5	65	10 × 13.5	45	10 × 13.5 (12.5 × 13.5)	45 (48)	10 × 13.5 (12.5 × 13.5)	42 45
10	100	10 × 13.5	75	10 × 13.5	70	12.5 × 13.5	50	12.5 × 13.5	50	12.5 × 13.5	70
22	220	12.5 × 13.5	105	12.5 × 13.5	105	16 × 16.5	85	16 × 16.5	85	16 × 16.5	85
33	330	12.5 × 13.5	120	16 × 16.5	180	18 × 16.5	100	18 × 16.5	100	18 × 16.5	100
47	470	16 × 16.5	220	16 × 16.5	220						
100	101	18 × 16.5	280	18 × 16.5	260					Case size 尺寸	Ripple current 紋波電流

•Case size $\varnothing D \times L$ (mm), ripple current (mA rms) at 105°C, 120Hz •尺寸 $\varnothing D \times L$ (mm), 紋波電流(mA rms)於 105°C, 120Hz

FREQUENCY COEFFICIENT OF ALLOWABLE RIPPLE CURRENT 紋波電流頻率補償系數

Frequency 頻率		50Hz	120Hz	300Hz	1KHz	10KHz~
Coefficient 系數	$\varnothing 4 \sim \varnothing 10$	0.1 ~ 68 μ F	0.70	1.00	1.17	1.36
		100 ~ 3300 μ F	0.85	1.00	1.08	1.20
	$\varnothing 12.5 \sim \varnothing 18$	~ 68 μ F	0.75	1.00	1.35	1.57
		100 ~ 680 μ F	0.80	1.00	1.23	1.34
		1000 ~ 6800 μ F	0.85	1.00	1.10	1.13

The endurance of capacitors is reduced with internal heating produced by ripple current at the rate of halving the lifetime with every 5~10°C rise. When long life performance is required in actual use, the rms ripple current has to be reduced. 鋁電解電容器在疊加紋波電流後會引起發熱，溫度每上升 5~10°C 壽命會減半。若要保持長壽命性能，請在使用過程中適當降低紋波電流。

- Taping specifications are given in page 17. 編帶標準請查閱第 17 頁。
- Soldering conditions and recommended land size are given in page 23. 焊接條件及推薦安裝尺寸請查閱第 23 頁。
- Please refer to page 18 for the minimum package quantity. 最小包裝數量請查閱第 18 頁。
- Please refer to page 15 for the Part Number System. 產品編碼規則請查閱第 15 頁。

Note: All design and specifications are for reference only and is subject to change without prior notice. If any doubt about safety for your application, please contact us immediately for technical assistance before purchase.

注：以上所提供的設計及特性參數僅供參考，任何修改不作預先通知。如果在使用上有疑問，請在採購前與我們聯繫，以便提供技術上的協助。

CAT.2023/V2

SC Series

CHIP TYPE, LOW LEAKAGE CURRENT

貼片式，低漏電流品



- Low leakage current (0.5~3.3 μ A max.)
低漏電流 (0.5~3.3 μ A 最大值)
- Low cost for replacement of some tantalum applications
可替換價格較高的鉭電容器
- RoHS & REACH compliant, Halogen-free
符合 RoHS 與 REACH, 無鹵

SPECIFICATIONS 特性表

Items 項目	Characteristics 主要特性																					
Category Temperature Range 工作溫度範圍	-55 ~ +85°C																					
Voltage Range 額定工作電壓範圍	6.3 ~ 50V																					
Capacitance Range 靜電容量範圍	0.1 ~ 220 μ F																					
Capacitance Tolerance 靜電容量允許偏差	\pm 20% at 120Hz, 20°C																					
Leakage Current 漏電流	Leakage current \leq 0.002CV or 0.5 μ A, whichever is greater (after 2 minutes application of rated voltage at 20°C) 漏電流 \leq 0.002CV 或 0.5 μ A, 取較大值 (在 20°C 環境中施加額定工作電壓 2 分鐘後) C: Nominal capacitance (μ F) 標稱靜電容量, V: Rated voltage (V) 額定電壓																					
Surge Voltage & Dissipation Factor (tan δ) 浪湧電壓和損耗角正切	Measurement frequency 測試頻率: 120Hz, Temperature 溫度: 20°C <table border="1"> <thead> <tr> <th>Rated Voltage (V) 額定工作電壓</th> <th>6.3</th> <th>10</th> <th>16</th> <th>25</th> <th>35</th> <th>50</th> </tr> </thead> <tbody> <tr> <td>Surge voltage 浪湧電壓</td> <td>8.0</td> <td>13</td> <td>20</td> <td>32</td> <td>44</td> <td>63</td> </tr> <tr> <td>tan δ (max.) 最大損耗角正切</td> <td>0.24</td> <td>0.20</td> <td>0.16</td> <td>0.14</td> <td>0.12</td> <td>0.10</td> </tr> </tbody> </table>	Rated Voltage (V) 額定工作電壓	6.3	10	16	25	35	50	Surge voltage 浪湧電壓	8.0	13	20	32	44	63	tan δ (max.) 最大損耗角正切	0.24	0.20	0.16	0.14	0.12	0.10
Rated Voltage (V) 額定工作電壓	6.3	10	16	25	35	50																
Surge voltage 浪湧電壓	8.0	13	20	32	44	63																
tan δ (max.) 最大損耗角正切	0.24	0.20	0.16	0.14	0.12	0.10																
Stability at Low Temperature 低溫特性	Measurement frequency 測試頻率: 120Hz <table border="1"> <thead> <tr> <th>Rated Voltage (V) 額定工作電壓</th> <th>6.3</th> <th>10</th> <th>16, 25</th> <th>35, 50</th> </tr> </thead> <tbody> <tr> <td>Impedance Ratio 阻抗比</td> <td>Z(-25°C) / Z(20°C)</td> <td>4</td> <td>3</td> <td>2</td> </tr> <tr> <td>ZT/Z20 (max.)</td> <td>Z(-40°C) / Z(20°C)</td> <td>8</td> <td>6</td> <td>4</td> </tr> </tbody> </table>	Rated Voltage (V) 額定工作電壓	6.3	10	16, 25	35, 50	Impedance Ratio 阻抗比	Z(-25°C) / Z(20°C)	4	3	2	ZT/Z20 (max.)	Z(-40°C) / Z(20°C)	8	6	4						
Rated Voltage (V) 額定工作電壓	6.3	10	16, 25	35, 50																		
Impedance Ratio 阻抗比	Z(-25°C) / Z(20°C)	4	3	2																		
ZT/Z20 (max.)	Z(-40°C) / Z(20°C)	8	6	4																		
Endurance 耐久性	After 2000 hours application of the rated voltage at 85°C, they meet the characteristics listed below. 在 85°C 環境中施加額定工作電壓 2000 小時後，電容器的特性符合下表的要求。 <table border="1"> <tbody> <tr> <td>Capacitance Change 靜電容量變化率</td> <td>Within \pm25% of initial value 初始值的\pm25%以內</td> </tr> <tr> <td>Dissipation Factor 損耗角正切</td> <td>200% or less of initial specified value 不大於規範值的 200%</td> </tr> <tr> <td>Leakage Current 漏電流</td> <td>initial specified value or less 不大於規範值</td> </tr> </tbody> </table>	Capacitance Change 靜電容量變化率	Within \pm 25% of initial value 初始值的 \pm 25%以內	Dissipation Factor 損耗角正切	200% or less of initial specified value 不大於規範值的 200%	Leakage Current 漏電流	initial specified value or less 不大於規範值															
Capacitance Change 靜電容量變化率	Within \pm 25% of initial value 初始值的 \pm 25%以內																					
Dissipation Factor 損耗角正切	200% or less of initial specified value 不大於規範值的 200%																					
Leakage Current 漏電流	initial specified value or less 不大於規範值																					
Resistance to Soldering Heat 耐焊接熱特性 (Please refer page 23 for soldering conditions) (焊接條件請查閱第 23 頁)	After reflow soldering and restored at room temperature, they meet the characteristics listed below. 經過回流焊並冷卻至室溫後，電容器的特性符合下表的要求。 <table border="1"> <tbody> <tr> <td>Capacitance Change 靜電容量變化率</td> <td>Within \pm10% of initial value 初始值的\pm10%以內</td> </tr> <tr> <td>Dissipation Factor 損耗角正切</td> <td>initial specified value or less 不大於規範值</td> </tr> <tr> <td>Leakage Current 漏電流</td> <td>initial specified value or less 不大於規範值</td> </tr> </tbody> </table>	Capacitance Change 靜電容量變化率	Within \pm 10% of initial value 初始值的 \pm 10%以內	Dissipation Factor 損耗角正切	initial specified value or less 不大於規範值	Leakage Current 漏電流	initial specified value or less 不大於規範值															
Capacitance Change 靜電容量變化率	Within \pm 10% of initial value 初始值的 \pm 10%以內																					
Dissipation Factor 損耗角正切	initial specified value or less 不大於規範值																					
Leakage Current 漏電流	initial specified value or less 不大於規範值																					
Marking 標識	Black print on the case top. 鋁殼頂部黑字印刷。																					

DRAWING 外形圖 (Unit: mm)

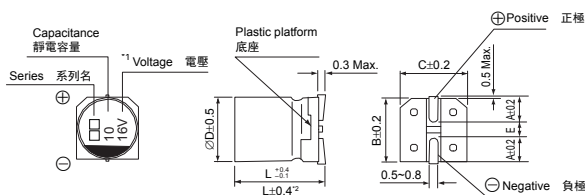

*1. Voltage mark for 6.3V is [6V]
*2. Applicable to $\phi 6.3 \times 7.7$

6.3V 的產品標識為 [6V]
適用於 $\phi 6.3 \times 7.7$

DIMENSIONS (Unit: mm) 尺寸表

$\phi D \times L$	4 x 5.4	5 x 5.4	6.3 x 5.4	6.3 x 7.7
A	2.0	2.2	2.6	2.6
B	4.3	5.3	6.6	6.6
C	4.3	5.3	6.6	6.6
E \pm 0.2	1.0	1.4	1.9	1.9
L	5.4	5.4	5.4	7.7

Note: All design and specifications are for reference only and is subject to change without prior notice. If any doubt about safety for your application, please contact us immediately for technical assistance before purchase.

注：以上所提供的設計及特性參數僅供參考，任何修改不作預先通知。如果在使用上有疑問，請在採購前與我們聯繫，以便提供技術上的協助。

CAT.2023/V2

SC Series

□ DIMENSIONS & MAXIMUM PERMISSIBLE RIPPLE CURRENT & ESR 規格尺寸及最大允許紋波電流及 ESR 值

Parameter 參數 μF		6.3 (0J)			10 (1A)			16 (1C)		
		Case size ØD×L (mm) 尺寸	E.S.R. (Ω) 20°C, 120Hz E.S.R.值	Ripple current (mA rms) at 85°C, 120Hz 紋波電流	Case size ØD×L (mm) 尺寸	E.S.R. (Ω) 20°C, 120Hz E.S.R.值	Ripple current (mA rms) at 85°C, 120Hz 紋波電流	Case size ØD×L (mm) 尺寸	E.S.R. (Ω) 20°C, 120Hz E.S.R.值	Ripple current (mA rms) at 85°C, 120Hz 紋波電流
10	100						4 × 5.4	34.5	25	
22	220	4 × 5.4	23.5	31	5 × 5.4	19.6	35	5 × 5.4	39	
33	330	5 × 5.4	15.7	39	5 × 5.4	13.1	43	6.3 × 5.4	57	
47	470	5 × 5.4	11.0	47	6.3 × 5.4	9.2	59	6.3 × 5.4	68	
100	101	6.3 × 5.4	5.2	75	6.3 × 5.4	4.3	76	6.3 × 7.7	96	
220	221	6.3 × 7.7	2.4	85						

Parameter 參數 μF		25 (1E)			35 (1V)			50 (1H)		
		Case size ØD×L (mm) 尺寸	E.S.R. (Ω) 20°C, 120Hz E.S.R.值	Ripple current (mA rms) at 85°C, 120Hz 紋波電流	Case size ØD×L (mm) 尺寸	E.S.R. (Ω) 20°C, 120Hz E.S.R.值	Ripple current (mA rms) at 85°C, 120Hz 紋波電流	Case size ØD×L (mm) 尺寸	E.S.R. (Ω) 20°C, 120Hz E.S.R.值	Ripple current (mA rms) at 85°C, 120Hz 紋波電流
0.1	0R1						4 × 5.4	2156	1.0	
0.22	R22						4 × 5.4	980	2.3	
0.33	R33						4 × 5.4	653	3.5	
0.47	R47						4 × 5.4	459	5	
1	010						4 × 5.4	216	10	
2.2	2R2						4 × 5.4	98	15	
3.3	3R3						4 × 5.4	65	18	
4.7	4R7	4 × 5.4	64.2	19	4 × 5.4	55.1	20	5 × 5.4	23	
10	100	5 × 5.4	30.2	28	5 × 5.4	25.9	30	6.3 × 5.4	34	
22	220	6.3 × 5.4	13.7	52	6.3 × 5.4	11.8	54	6.3 × 7.7	85	
33	330	6.3 × 5.4	9.1	63	6.3 × 7.7	7.8	105			
47	470	6.3 × 7.7	6.4	100	6.3 × 7.7	5.5	110			

□ FREQUENCY COEFFICIENT OF ALLOWABLE RIPPLE CURRENT 紋波電流頻率補償系數

Frequency 頻率	~50Hz	120Hz	300Hz	1KHz	10KHz~
Coefficient 系數	0.70	1.00	1.17	1.36	1.50

The endurance of capacitors is reduced with internal heating produced by ripple current at the rate of halving the lifetime with every 5~10°C rise. When long life performance is required in actual use, the rms ripple current has to be reduced. 鋁電解電容器在疊加紋波電流後會引起發熱，溫度每上升 5~10°C 壽命會減半。若要保持長壽命性能，請在使用過程中適當降低紋波電流。

- Taping specifications are given in page 17. 編帶標準請查閱第 17 頁。
- Soldering conditions and recommended land size are given in page 23. 焊接條件及推薦安裝尺寸請查閱第 23 頁。
- Please refer to page 18 for the minimum package quantity. 最小包裝數量請查閱第 18 頁。
- Please refer to page 15 for the Part Number System. 產品編碼規則請查閱第 15 頁。

Note: All design and specifications are for reference only and is subject to change without prior notice. If any doubt about safety for your application, please contact us immediately for technical assistance before purchase.

注：以上所提供的設計及特性參數僅供參考，任何修改不作預先通知。如果在使用上有疑問，請在採購前與我們聯繫，以便提供技術上的協助。

CAT.2023/V2

CN Series

CHIP TYPE, NON-POLARIZED

貼片式，無極性品

- Non-polarized with general temperature +85°C
無極性和適用於 +85°C 的常規溫度
- Endurance 1000 hours
耐久性 1000 小時
- RoHS & REACH compliant, Halogen-free
符合 RoHS 與 REACH，無鹵

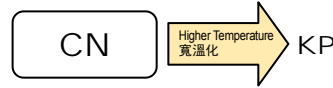

□ SPECIFICATIONS 特性表

Items 項目	Characteristics 主要特性																	
Category Temperature Range 工作溫度範圍	-55 ~ +85°C																	
Voltage Range 額定工作電壓範圍	6.3 ~ 50V																	
Capacitance Range 靜電容量範圍	0.1 ~ 100μF																	
Capacitance Tolerance 靜電容量允許偏差	±20% at 120Hz, 20°C																	
Leakage Current 漏電流	Leakage current ≤0.05CV or 10μA, whichever is greater (after 2 minutes application of rated voltage at 20°C) 漏電流 ≤0.05CV 或 10μA，取較大值（在 20°C 環境中施加額定工作電壓 2 分鐘後） C: Nominal capacitance (μF) 標稱靜電容量, V: Rated voltage (V) 額定電壓																	
Dissipation Factor (tan δ) 損耗角正切	Measurement frequency 測試頻率: 120Hz, Temperature 溫度: 20°C <table border="1"> <tr> <td>Rated Voltage (V) 額定工作電壓</td> <td>6.3</td> <td>10</td> <td>16, 25</td> <td>35, 50</td> </tr> <tr> <td>tan δ (max.) 最大損耗角正切</td> <td>0.24</td> <td>0.20</td> <td>0.17</td> <td>0.15</td> </tr> </table>	Rated Voltage (V) 額定工作電壓	6.3	10	16, 25	35, 50	tan δ (max.) 最大損耗角正切	0.24	0.20	0.17	0.15							
Rated Voltage (V) 額定工作電壓	6.3	10	16, 25	35, 50														
tan δ (max.) 最大損耗角正切	0.24	0.20	0.17	0.15														
Stability at Low Temperature 低溫特性	Measurement frequency 測試頻率: 120Hz <table border="1"> <tr> <td>Rated Voltage (V) 額定工作電壓</td> <td>6.3</td> <td>10</td> <td>16, 25</td> <td>35, 50</td> </tr> <tr> <td>Impedance Ratio 阻抗比</td> <td>Z(-25°C) / Z(20°C)</td> <td>4</td> <td>3</td> <td>2</td> <td>2</td> </tr> <tr> <td>ZT/Z20 (max.)</td> <td>Z(-55°C) / Z(20°C)</td> <td>8</td> <td>6</td> <td>4</td> <td>3</td> </tr> </table>	Rated Voltage (V) 額定工作電壓	6.3	10	16, 25	35, 50	Impedance Ratio 阻抗比	Z(-25°C) / Z(20°C)	4	3	2	2	ZT/Z20 (max.)	Z(-55°C) / Z(20°C)	8	6	4	3
Rated Voltage (V) 額定工作電壓	6.3	10	16, 25	35, 50														
Impedance Ratio 阻抗比	Z(-25°C) / Z(20°C)	4	3	2	2													
ZT/Z20 (max.)	Z(-55°C) / Z(20°C)	8	6	4	3													
Endurance 耐久性	After 1000 hours application of the rated voltage at 85°C (the polarity needs to exchange every 250 hours), they meet the characteristics listed below. 在 85°C 環境中施加額定工作電壓 1000 小時（每 250 小時必須轉換一次極性）後，電容器的特性符合下表的要求。 <table border="1"> <tr> <td>Capacitance Change 靜電容量變化率</td> <td>Within ±20% of initial value 初始值的±20%以內</td> </tr> <tr> <td>Dissipation Factor 損耗角正切</td> <td>200% or less of initial specified value 不大於規範值的 200%</td> </tr> <tr> <td>Leakage Current 漏電流</td> <td>initial specified value or less 不大於規範值</td> </tr> </table>	Capacitance Change 靜電容量變化率	Within ±20% of initial value 初始值的±20%以內	Dissipation Factor 損耗角正切	200% or less of initial specified value 不大於規範值的 200%	Leakage Current 漏電流	initial specified value or less 不大於規範值											
Capacitance Change 靜電容量變化率	Within ±20% of initial value 初始值的±20%以內																	
Dissipation Factor 損耗角正切	200% or less of initial specified value 不大於規範值的 200%																	
Leakage Current 漏電流	initial specified value or less 不大於規範值																	
Shelf Life 高溫貯存特性	After leaving capacitors under no load at 85°C for 1000 hours, they meet the specified value for load life characteristics listed above. 在 85°C 環境中無負荷放置 1000 小時後，電容器的特性符合高溫負荷特性中所列的規定值。																	
Resistance to Soldering Heat 耐焊接熱特性 (Please refer page 23 for soldering conditions) (焊接條件請查閱第 23 頁)	After reflow soldering and restored at room temperature, they meet the characteristics listed below. 經過回流焊並冷卻至室溫後，電容器的特性符合下表的要求。 <table border="1"> <tr> <td>Capacitance Change 靜電容量變化率</td> <td>Within ±10% of initial value 初始值的±10%以內</td> </tr> <tr> <td>Dissipation Factor 損耗角正切</td> <td>initial specified value or less 不大於規範值</td> </tr> <tr> <td>Leakage Current 漏電流</td> <td>initial specified value or less 不大於規範值</td> </tr> </table>	Capacitance Change 靜電容量變化率	Within ±10% of initial value 初始值的±10%以內	Dissipation Factor 損耗角正切	initial specified value or less 不大於規範值	Leakage Current 漏電流	initial specified value or less 不大於規範值											
Capacitance Change 靜電容量變化率	Within ±10% of initial value 初始值的±10%以內																	
Dissipation Factor 損耗角正切	initial specified value or less 不大於規範值																	
Leakage Current 漏電流	initial specified value or less 不大於規範值																	
Marking 標識	Black print on the case top. 鋁殼頂部黑字印刷。																	

□ DRAWING 外形圖 (Unit: mm)

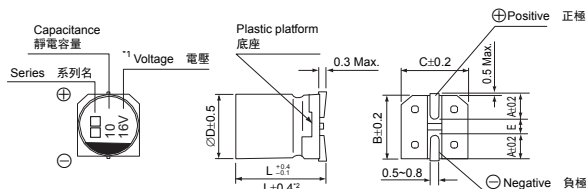

*1. Voltage mark for 6.3V is [6V]

*2. Applicable to Ø6.3x7.7

6.3V 的產品標識為 [6V]

適用於Ø6.3x7.7

□ DIMENSIONS (Unit: mm) 尺寸表

ØD x L	4 x 5.4	5 x 5.4	6.3 x 5.4	6.3 x 7.7	8 x 10.5
A	2.0	2.2	2.6	2.6	3.0
B	4.3	5.3	6.6	6.6	8.4
C	4.3	5.3	6.6	6.6	8.4
E ± 0.2	1.0	1.4	1.9	1.9	3.1
L	5.4	5.4	5.4	7.7	10.5

Note: All design and specifications are for reference only and is subject to change without prior notice. If any doubt about safety for your application, please contact us immediately for technical assistance before purchase.

注: 以上所提供的設計及特性參數僅供參考，任何修改不作預先通知。如果在使用上有疑問，請在採購前與我們聯繫，以便提供技術上的協助。

CAT.2023/V2

CN Series

DIMENSIONS & MAXIMUM PERMISSIBLE RIPPLE CURRENT 規格尺寸及最大允許紋波電流

WV Code 代碼	6.3		10		16		25		35		50		
	0J		1A		1C		1E		1V		1H		
0.1	0R1											4 × 5.4	1.0
0.22	R22											4 × 5.4	2.0
0.33	R33											4 × 5.4	2.8
0.47	R47											4 × 5.4	4.0
1	010											4 × 5.4	8.4
2.2	2R2									4 × 5.4	8.4	5 × 5.4	13
3.3	3R3							5 × 5.4	12	5 × 5.4	16	5 × 5.4	17
4.7	4R7					4 × 5.4	12	5 × 5.4	16	5 × 5.4	18	6.3 × 5.4	20
10	100			4 × 5.4	17	5 × 5.4	23	6.3 × 5.4	27	6.3 × 5.4	29	6.3 × 5.4 (6.3 × 7.7)	32 (36)
22	220	5 × 5.4	28	6.3 × 5.4	33	6.3 × 5.4	37	6.3 × 7.7	50	6.3 × 7.7	54	6.3 × 7.7 (8 × 10.5)	60 (65)
33	330	6.3 × 5.4	37	6.3 × 5.4	41	6.3 × 5.4	49	6.3 × 7.7	61				
47	470	6.3 × 5.4	45	6.3 × 7.7	61	6.3 × 7.7	75						
100	101	6.3 × 7.7	82	6.3 × 7.7	85								
												Case size 尺寸	Ripple current 紋波電流

•Case size $\varnothing D \times L$ (mm), ripple current (mA rms) at 85°C, 120Hz •尺寸 $\varnothing D \times L$ (mm), 紋波電流(mA rms)於 85°C, 120Hz

FREQUENCY COEFFICIENT OF ALLOWABLE RIPPLE CURRENT 紋波電流頻率補償系數

Frequency 頻率	50Hz	120Hz	300Hz	1KHz	10KHz~
Coefficient 系數	0.70	1.00	1.17	1.36	1.50

The endurance of capacitors is reduced with internal heating produced by ripple current at the rate of halving the lifetime with every 5~10°C rise. When long life performance is required in actual use, the rms ripple current has to be reduced. 鋁電解電容器在疊加紋波電流後會引起發熱，溫度每上升 5~10°C 壽命會減半。若要保持長壽命性能，請在使用過程中適當降低紋波電流。

- Taping specifications are given in page 17. 編帶標準請查閱第 17 頁。
- Soldering conditions and recommended land size are given in page 23. 焊接條件及推薦安裝尺寸請查閱第 23 頁。
- Please refer to page 18 for the minimum package quantity. 最小包裝數量請查閱第 18 頁。
- Please refer to page 15 for the Part Number System. 產品編碼規則請查閱第 15 頁。

Note: All design and specifications are for reference only and is subject to change without prior notice. If any doubt about safety for your application, please contact us immediately for technical assistance before purchase.

注：以上所提供的設計及特性參數僅供參考，任何修改不作預先通知。如果在使用上有疑問，請在採購前與我們聯繫，以便提供技術上的協助。

CAT.2023/V2

KP Series

CHIP TYPE, NON-POLARIZED, WIDE TEMPERATURE

貼片式，無極性寬溫品

- Non-polarized with wide temperature range -55°C~+105°C
無極性和適用於 -55°C~+105°C 的寬溫範圍
- Endurance 1000 hours
耐久性 1000 小時
- RoHS & REACH compliant, Halogen-free
符合 RoHS 與 REACH，無鹵

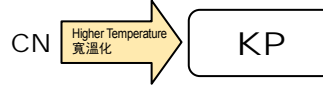

□ SPECIFICATIONS 特性表

Items 項目	Characteristics 主要特性																
Category Temperature Range 工作溫度範圍	-55 ~ +105°C																
Voltage Range 額定工作電壓範圍	6.3 ~ 50V																
Capacitance Range 靜電容量範圍	0.1 ~ 47µF																
Capacitance Tolerance 靜電容量允許偏差	±20% at 120Hz, 20°C																
Leakage Current 漏電流	Leakage current ≤0.05CV or 10µA, whichever is greater (after 2 minutes application of rated voltage at 20°C) 漏電流 ≤0.05CV 或 10µA，取較大值（在 20°C 環境中施加額定工作電壓 2 分鐘後） C: Nominal capacitance (µF) 標稱靜電容量, V: Rated voltage (V) 額定電壓																
Dissipation Factor (tan δ) 損耗角正切	Measurement frequency 測試頻率: 120Hz, Temperature 溫度: 20°C <table border="1"> <tr> <td>Rated Voltage (V) 額定工作電壓</td> <td>6.3</td> <td>10</td> <td>16, 25</td> <td>35, 50</td> </tr> <tr> <td>tan δ (max.) 最大損耗角正切</td> <td>0.24</td> <td>0.20</td> <td>0.17</td> <td>0.15</td> </tr> </table>	Rated Voltage (V) 額定工作電壓	6.3	10	16, 25	35, 50	tan δ (max.) 最大損耗角正切	0.24	0.20	0.17	0.15						
Rated Voltage (V) 額定工作電壓	6.3	10	16, 25	35, 50													
tan δ (max.) 最大損耗角正切	0.24	0.20	0.17	0.15													
Stability at Low Temperature 低溫特性	Measurement frequency 測試頻率: 120Hz <table border="1"> <tr> <td>Rated Voltage (V) 額定工作電壓</td> <td>6.3</td> <td>10</td> <td>16, 25</td> <td>35, 50</td> </tr> <tr> <td rowspan="2">Impedance Ratio 阻抗比</td> <td>Z(-25°C) / Z(20°C)</td> <td>4</td> <td>3</td> <td>2</td> <td>2</td> </tr> <tr> <td>ZT/Z20 (max.)</td> <td>8</td> <td>6</td> <td>4</td> <td>3</td> </tr> </table>	Rated Voltage (V) 額定工作電壓	6.3	10	16, 25	35, 50	Impedance Ratio 阻抗比	Z(-25°C) / Z(20°C)	4	3	2	2	ZT/Z20 (max.)	8	6	4	3
Rated Voltage (V) 額定工作電壓	6.3	10	16, 25	35, 50													
Impedance Ratio 阻抗比	Z(-25°C) / Z(20°C)	4	3	2	2												
	ZT/Z20 (max.)	8	6	4	3												
Endurance 耐久性	After 1000 hours application of the rated voltage at 105°C (the polarity needs to exchange every 250 hours), they meet the characteristics listed below. 在 105°C 環境中施加額定工作電壓 1000 小時（每 250 小時必須轉換一次極性）後，電容器的特性符合下表的要求。 <table border="1"> <tr> <td>Capacitance Change 靜電容量變化率</td> <td>Within ±20% of initial value 初始值的±20%以內</td> </tr> <tr> <td>Dissipation Factor 損耗角正切</td> <td>200% or less of initial specified value 不大於規範值的 200%</td> </tr> <tr> <td>Leakage Current 漏電流</td> <td>initial specified value or less 不大於規範值</td> </tr> </table>	Capacitance Change 靜電容量變化率	Within ±20% of initial value 初始值的±20%以內	Dissipation Factor 損耗角正切	200% or less of initial specified value 不大於規範值的 200%	Leakage Current 漏電流	initial specified value or less 不大於規範值										
Capacitance Change 靜電容量變化率	Within ±20% of initial value 初始值的±20%以內																
Dissipation Factor 損耗角正切	200% or less of initial specified value 不大於規範值的 200%																
Leakage Current 漏電流	initial specified value or less 不大於規範值																
Shelf Life 高溫貯存特性	After leaving capacitors under no load at 105°C for 1000 hours, they meet the specified value for load life characteristics listed above. 在 105°C 環境中無負荷放置 1000 小時後，電容器的特性符合高溫負荷特性中所列的規定值。																
Resistance to Soldering Heat 耐焊接熱特性 (Please refer page 23 for soldering conditions) (焊接條件請查閱第 23 頁)	After reflow soldering and restored at room temperature, they meet the characteristics listed below. 經過回流焊並冷卻至室溫後，電容器的特性符合下表的要求。 <table border="1"> <tr> <td>Capacitance Change 靜電容量變化率</td> <td>Within ±10% of initial value 初始值的±10%以內</td> </tr> <tr> <td>Dissipation Factor 損耗角正切</td> <td>initial specified value or less 不大於規範值</td> </tr> <tr> <td>Leakage Current 漏電流</td> <td>initial specified value or less 不大於規範值</td> </tr> </table>	Capacitance Change 靜電容量變化率	Within ±10% of initial value 初始值的±10%以內	Dissipation Factor 損耗角正切	initial specified value or less 不大於規範值	Leakage Current 漏電流	initial specified value or less 不大於規範值										
Capacitance Change 靜電容量變化率	Within ±10% of initial value 初始值的±10%以內																
Dissipation Factor 損耗角正切	initial specified value or less 不大於規範值																
Leakage Current 漏電流	initial specified value or less 不大於規範值																
Marking 標識	Black print on the case top. 鋁殼頂部黑字印刷。																

□ DRAWING 外形圖 (Unit: mm)

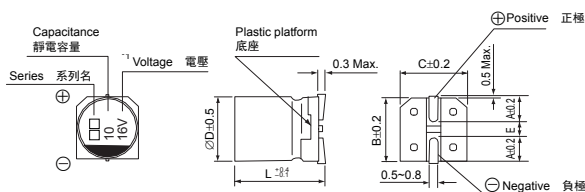

*1. Voltage mark for 6.3V is [6V]

6.3V 的產品標識為 [6V]

□ DIMENSIONS (Unit: mm) 尺寸表

ØD x L	4 x 5.4	5 x 5.4	6.3 x 5.4
A	2.0	2.2	2.6
B	4.3	5.3	6.6
C	4.3	5.3	6.6
E ± 0.2	1.0	1.4	1.9
L	5.4	5.4	5.4

Note: All design and specifications are for reference only and is subject to change without prior notice. If any doubt about safety for your application, please contact us immediately for technical assistance before purchase.

注: 以上所提供的設計及特性參數僅供參考，任何修改不作預先通知。如果在使用上有疑問，請在採購前與我們聯繫，以便提供技術上的協助。

CAT.2023/V2

KP Series

□ DIMENSIONS & MAXIMUM PERMISSIBLE RIPPLE CURRENT 規格尺寸及最大允許紋波電流

WV Code 代碼	6.3		10		16		25		35		50		
	0J		1A		1C		1E		1V		1H		
0.1	0R1											4 × 5.4	1.0
0.22	R22											4 × 5.4	2.0
0.33	R33											4 × 5.4	2.8
0.47	R47											4 × 5.4	4.0
1	010											4 × 5.4	8.4
2.2	2R2									4 × 5.4	8.4	5 × 5.4	13
3.3	3R3							5 × 5.4	12	5 × 5.4	16	5 × 5.4	17
4.7	4R7					4 × 5.4	12	5 × 5.4	16	5 × 5.4	18	6.3 × 5.4	20
10	100			4 × 5.4	17	5 × 5.4	23	6.3 × 5.4	27	6.3 × 5.4	29		
22	220	5 × 5.4	28	6.3 × 5.4	33	6.3 × 5.4	37						
33	330	6.3 × 5.4	37	6.3 × 5.4	41	6.3 × 5.4	49					Case size 尺寸	Ripple current 紋波電流
47	470	6.3 × 5.4	45										

•Case size $\varnothing D \times L$ (mm), ripple current (mA rms) at 105°C, 120Hz •尺寸 $\varnothing D \times L$ (mm), 紋波電流(mA rms)於 105°C, 120Hz

□ FREQUENCY COEFFICIENT OF ALLOWABLE RIPPLE CURRENT 紋波電流頻率補償系數

Frequency 頻率	50Hz	120Hz	300Hz	1KHz	10KHz~
Coefficient 系數	0.70	1.00	1.17	1.36	1.50

The endurance of capacitors is reduced with internal heating produced by ripple current at the rate of halving the lifetime with every 5~10°C rise. When long life performance is required in actual use, the rms ripple current has to be reduced. 鋁電解電容器在疊加紋波電流後會引起發熱，溫度每上升 5~10°C 壽命會減半。若要保持長壽命性能，請在使用過程中適當降低紋波電流。

- Taping specifications are given in page 17. 編帶標準請查閱第 17 頁。
- Soldering conditions and recommended land size are given in page 23. 焊接條件及推薦安裝尺寸請查閱第 23 頁。
- Please refer to page 18 for the minimum package quantity. 最小包裝數量請查閱第 18 頁。
- Please refer to page 15 for the Part Number System. 產品編碼規則請查閱第 15 頁。

Note: All design and specifications are for reference only and is subject to change without prior notice. If any doubt about safety for your application, please contact us immediately for technical assistance before purchase.

注：以上所提供的設計及特性參數僅供參考，任何修改不作預先通知。如果在使用上有疑問，請在採購前與我們聯繫，以便提供技術上的協助。

CAT.2023/V2

LZ Series

CHIP TYPE, LOW IMPEDANCE

貼片式，低阻抗品

- Low impedance 低阻抗
- Endurance 1000~2000 hours 耐久性 1000~2000 小時
- RoHS & REACH compliant, Halogen-free 符合 RoHS 與 REACH，無鹵



SPECIFICATIONS 特性表

Items 項目	Characteristics 主要特性																																
Category 工作溫度範圍	-55 ~ +105°C																																
Voltage Range 額定工作電壓範圍	6.3 ~ 100V																																
Capacitance Range 靜電容量範圍	1 ~ 4700µF																																
Capacitance Tolerance 靜電容量允許偏差	±20% at 120Hz, 20°C																																
Leakage Current 漏電流	Leakage current ≤0.01CV or 3µA (∅4~∅10), whichever is greater (after 2 minutes application of rated voltage at 20°C) Leakage current ≤0.03CV or 4µA (∅12.5~∅16), whichever is greater (after 1 minute application of rated voltage at 20°C) 漏電流 ≤0.01CV 或 3µA (∅4~∅10)，取較大值（在 20°C 環境中施加額定工作電壓 2 分鐘後） 漏電流 ≤0.03CV 或 4µA (∅12.5~∅16)，取較大值（在 20°C 環境中施加額定工作電壓 1 分鐘後）																																
Dissipation Factor (tan δ) 損耗角正切	C: Nominal capacitance (µF) 標稱靜電容量, V: Rated voltage (V) 額定電壓 Measurement frequency 測試頻率: 120Hz, Temperature 溫度: 20°C <table border="1"> <thead> <tr> <th>Rated Voltage (V) 額定工作電壓</th> <th>6.3</th> <th>10</th> <th>16</th> <th>25</th> <th>35</th> <th>50, 63</th> <th>80, 100</th> </tr> </thead> <tbody> <tr> <td>tan δ (max.) ∅4~∅10</td> <td>0.22</td> <td>0.19</td> <td>0.16</td> <td>0.14</td> <td>0.12</td> <td>0.12</td> <td>0.10</td> </tr> <tr> <td>最大損耗角正切 ∅12.5~∅16</td> <td>0.26</td> <td>0.22</td> <td>0.18</td> <td>0.16</td> <td>0.14</td> <td>0.12</td> <td>0.10</td> </tr> </tbody> </table>	Rated Voltage (V) 額定工作電壓	6.3	10	16	25	35	50, 63	80, 100	tan δ (max.) ∅4~∅10	0.22	0.19	0.16	0.14	0.12	0.12	0.10	最大損耗角正切 ∅12.5~∅16	0.26	0.22	0.18	0.16	0.14	0.12	0.10								
Rated Voltage (V) 額定工作電壓	6.3	10	16	25	35	50, 63	80, 100																										
tan δ (max.) ∅4~∅10	0.22	0.19	0.16	0.14	0.12	0.12	0.10																										
最大損耗角正切 ∅12.5~∅16	0.26	0.22	0.18	0.16	0.14	0.12	0.10																										
Stability at Low Temperature 低溫特性	Measurement frequency 測試頻率: 120Hz <table border="1"> <thead> <tr> <th>Rated Voltage (V) 額定工作電壓</th> <th>6.3</th> <th>10</th> <th>16</th> <th>25</th> <th>35~100</th> </tr> </thead> <tbody> <tr> <td rowspan="4">Impedance Ratio 阻抗比 ZT/Z20 (max.)</td> <td rowspan="2">∅4~∅10</td> <td>Z(-25°C) / Z(20°C)</td> <td>2</td> <td>2</td> <td>2</td> <td>2</td> </tr> <tr> <td>Z(-55°C) / Z(20°C)</td> <td>5</td> <td>4</td> <td>4</td> <td>3</td> <td>3</td> </tr> <tr> <td rowspan="2">∅12.5~∅16</td> <td>Z(-25°C) / Z(20°C)</td> <td>3</td> <td>3</td> <td>2</td> <td>2</td> <td>2</td> </tr> <tr> <td>Z(-55°C) / Z(20°C)</td> <td>10</td> <td>8</td> <td>6</td> <td>4</td> <td>3</td> </tr> </tbody> </table>	Rated Voltage (V) 額定工作電壓	6.3	10	16	25	35~100	Impedance Ratio 阻抗比 ZT/Z20 (max.)	∅4~∅10	Z(-25°C) / Z(20°C)	2	2	2	2	Z(-55°C) / Z(20°C)	5	4	4	3	3	∅12.5~∅16	Z(-25°C) / Z(20°C)	3	3	2	2	2	Z(-55°C) / Z(20°C)	10	8	6	4	3
Rated Voltage (V) 額定工作電壓	6.3	10	16	25	35~100																												
Impedance Ratio 阻抗比 ZT/Z20 (max.)	∅4~∅10	Z(-25°C) / Z(20°C)	2	2	2	2																											
		Z(-55°C) / Z(20°C)	5	4	4	3	3																										
	∅12.5~∅16	Z(-25°C) / Z(20°C)	3	3	2	2	2																										
		Z(-55°C) / Z(20°C)	10	8	6	4	3																										
Endurance 耐久性	After 2000 hours application of the rated voltage at 105°C, they meet the characteristics listed below. 在 105°C 環境中施加額定工作電壓 2000 小時後，電容器的特性符合下表的要求。 <table border="1"> <tbody> <tr> <td>Capacitance Change 靜電容量變化率</td> <td>Within ±20% of initial value 初始值的±20%以內</td> </tr> <tr> <td>Dissipation Factor 損耗角正切</td> <td>200% or less of initial specified value 不大於規範值的 200%</td> </tr> <tr> <td>Leakage Current 漏電流</td> <td>initial specified value or less 不大於規範值</td> </tr> </tbody> </table>	Capacitance Change 靜電容量變化率	Within ±20% of initial value 初始值的±20%以內	Dissipation Factor 損耗角正切	200% or less of initial specified value 不大於規範值的 200%	Leakage Current 漏電流	initial specified value or less 不大於規範值																										
Capacitance Change 靜電容量變化率	Within ±20% of initial value 初始值的±20%以內																																
Dissipation Factor 損耗角正切	200% or less of initial specified value 不大於規範值的 200%																																
Leakage Current 漏電流	initial specified value or less 不大於規範值																																
Shelf Life 高溫貯存特性	After leaving capacitors under no load at 105°C for 1000 hours, they meet the specified value for load life characteristics listed above. 在 105°C 環境中無負荷放置 1000 小時後，電容器的特性符合高溫負荷特性中所列的規定值。																																
Resistance to Soldering Heat 耐焊接熱特性 (Please refer page 23 for soldering conditions) (焊接條件請查閱第 23 頁)	After reflow soldering and restored at room temperature, they meet the characteristics listed below. 經過回流焊並冷卻至室溫後，電容器的特性符合下表的要求。 <table border="1"> <tbody> <tr> <td>Capacitance Change 靜電容量變化率</td> <td>Within ±10% of initial value 初始值的±10%以內</td> </tr> <tr> <td>Dissipation Factor 損耗角正切</td> <td>initial specified value or less 不大於規範值</td> </tr> <tr> <td>Leakage Current 漏電流</td> <td>initial specified value or less 不大於規範值</td> </tr> </tbody> </table>	Capacitance Change 靜電容量變化率	Within ±10% of initial value 初始值的±10%以內	Dissipation Factor 損耗角正切	initial specified value or less 不大於規範值	Leakage Current 漏電流	initial specified value or less 不大於規範值																										
Capacitance Change 靜電容量變化率	Within ±10% of initial value 初始值的±10%以內																																
Dissipation Factor 損耗角正切	initial specified value or less 不大於規範值																																
Leakage Current 漏電流	initial specified value or less 不大於規範值																																
Marking 標識	Black print on the case top. 鋁殼頂部黑字印刷。																																

DRAWING 外形圖 (Unit: mm)

(∅4~∅6.3×7.7)

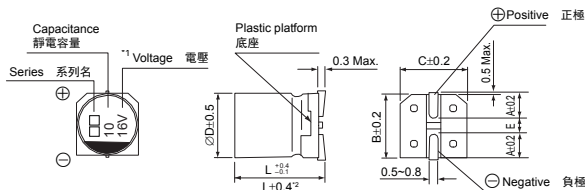

(∅8×10.5~∅16)

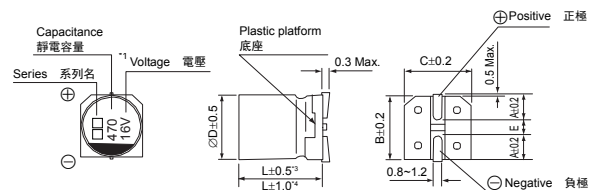

*1. Voltage mark for 6.3V is [6V]
*2. Applicable to ∅6.3×7.7
*3. Applicable to ∅8×10.5~∅10
*4. Applicable to ∅12.5~∅16

6.3V 的產品標識為 [6V]
適用於 ∅6.3×7.7
適用於 ∅8×10.5~∅10
適用於 ∅12.5~∅16

Dimension table in next page.
尺寸表見下一頁。

Note: All design and specifications are for reference only and is subject to change without prior notice. If any doubt about safety for your application, please contact us immediately for technical assistance before purchase.

注：以上所提供的設計及特性參數僅供參考，任何修改不作預先通知。如果在使用上有疑問，請在採購前與我們聯繫，以便提供技術上的協助。

CAT.2023/V2

LZ Series

□ DIMENSIONS (Unit: mm) 尺寸表

∅D x L	4 x 5.4	5 x 5.4	6.3 x 5.4	6.3 x 7.7	8 x 10.5	10 x 10.5	10 x 13.5	12.5 x 13.5	12.5 x 16	16 x 16.5
A	2.0	2.2	2.6	2.6	3.0	3.3	3.3	4.9	4.9	5.8
B	4.3	5.3	6.6	6.6	8.4	10.4	10.4	13.0	13.0	17.0
C	4.3	5.3	6.6	6.6	8.4	10.4	10.4	13.0	13.0	17.0
E ± 0.2	1.0	1.4	1.9	1.9	3.1	4.7	4.7	4.7	4.7	6.4
L	5.4	5.4	5.4	7.7	10.5	10.5	13.5	13.5	16.0	16.5

□ DIMENSIONS & MAXIMUM PERMISSIBLE RIPPLE CURRENT & IMPEDANCE 規格尺寸及最大允許紋波電流及阻抗值

μF	WV Code 代碼	6.3			10			16		
		0J			1A			1C		
10	100							4 x 5.4	3.0	60
15	150							5 x 5.4 (4 x 5.4)	1.8 (3.0)	95 (60)
22	220	4 x 5.4	3.0	60	5 x 5.4 (4 x 5.4)	1.8 (3.0)	95 (60)	5 x 5.4 (4 x 5.4)	1.8 (3.0)	95 (60)
33	330	5 x 5.4 (4 x 5.4)	1.8 (3.0)	95 (60)	5 x 5.4 (4 x 5.4)	1.8 (3.0)	95 (60)	6.3 x 5.4 (5 x 5.4)	1.0 (1.8)	140 (95)
47	470	5 x 5.4 (4 x 5.4)	1.8 (3.0)	95 (60)	6.3 x 5.4 (5 x 5.4)	1.0 (1.8)	140 (95)	6.3 x 5.4 (5 x 5.4)	1.0 (1.8)	140 (95)
68	680	6.3 x 5.4 (5 x 5.4)	1.0 (1.8)	140 (95)	6.3 x 5.4	1.0	140	6.3 x 7.7 (6.3 x 5.4)	0.6 (1.0)	230 (140)
100	101	6.3 x 5.4 (5 x 5.4)	1.0 (1.8)	140 (95)	6.3 x 7.7 (6.3 x 5.4)	0.6 (1.0)	230 (140)	6.3 x 7.7 (6.3 x 5.4)	0.6 (1.0)	230 (140)
150	151	6.3 x 7.7 (6.3 x 5.4)	0.6 (1.0)	230 (140)	6.3 x 7.7 (6.3 x 5.4)	0.6 (1.0)	230 (140)	6.3 x 7.7	0.6	230
220	221	6.3 x 7.7 (6.3 x 5.4)	0.6 (1.0)	230 (140)	6.3 x 7.7	0.6	230	8 x 10.5 (6.3 x 7.7)	0.3 (0.6)	450 (230)
330	331	6.3 x 7.7	0.6	230	8 x 10.5	0.3	450	10 x 10.5 (8 x 10.5)	0.15 (0.3)	670 (450)
470	471	8 x 10.5 (6.3 x 7.7)	0.3 (0.6)	450 (230)	8 x 10.5	0.3	450	10 x 10.5 (8 x 10.5)	0.15 (0.3)	670 (450)
680	681	8 x 10.5	0.3	450	10 x 10.5	0.15	670	10 x 10.5	0.15	670
1000	102	10 x 10.5 (8 x 10.5)	0.15 (0.3)	670 (450)	10 x 10.5	0.15	670	10 x 10.5	0.15	670
1500	152	10 x 13.5 (10 x 10.5)	0.13 (0.15)	750 (670)	12.5 x 13.5 (10 x 13.5)	0.11 (0.13)	820 (750)	12.5 x 13.5	0.11	820
2200	222	12.5 x 13.5 (10 x 13.5)	0.11 (0.13)	820 (750)	12.5 x 16	0.09	950	16 x 16.5 (12.5 x 16)	0.08 (0.09)	1260 (950)
3300	332	12.5 x 16 (12.5 x 13.5)	0.09 (0.11)	950 (820)	16 x 16.5	0.08	1260	16 x 16.5	0.08	1260
4700	472	16 x 16.5	0.08	1260	16 x 16.5	0.08	1260			

μF	WV Code 代碼	25			35			50		
		1E			1V			1H		
1	010				4 x 5.4	3.0	60	4 x 5.4	5.0	30
1.5	1R5				4 x 5.4	3.0	60	4 x 5.4	5.0	30
2.2	2R2				4 x 5.4	3.0	60	4 x 5.4	5.0	30
3.3	3R3				4 x 5.4	3.0	60	4 x 5.4	5.0	30
4.7	4R7	4 x 5.4	3.0	60	4 x 5.4	3.0	60	5 x 5.4	3.0	50
6.8	6R8	4 x 5.4	3.0	60	5 x 5.4	1.8	95	6.3 x 5.4	2.0	70
10	100	5 x 5.4 (4 x 5.4)	1.8 (3.0)	95 (60)	5 x 5.4 (4 x 5.4)	1.8 (3.0)	95 (60)	6.3 x 5.4	2.0	70
15	150	6.3 x 5.4	1.8	95	5 x 5.4	1.8	95	6.3 x 5.4	2.0	70
22	220	6.3 x 5.4 (5 x 5.4)	1.0 (1.8)	140 (95)	6.3 x 5.4 (5 x 5.4)	1.0 (1.8)	140 (95)	6.3 x 7.7 (6.3 x 5.4)	1.0 (2.0)	120 (70)
33	330	6.3 x 5.4 (5 x 5.4)	1.0 (1.8)	140 (95)	6.3 x 7.7 (6.3 x 5.4)	0.6 (1.0)	230 (140)	6.3 x 7.7	1.0	120
47	470	6.3 x 7.7 (6.3 x 5.4)	0.6 (1.0)	230 (140)	6.3 x 7.7 (6.3 x 5.4)	0.6 (1.0)	230 (140)	6.3 x 7.7	1.0	120
68	680	6.3 x 7.7	0.6	230	6.3 x 7.7	0.6	230	8 x 10.5	0.6	300
100	101	6.3 x 7.7	0.6	230	8 x 10.5 (6.3 x 7.7)	0.3 (0.6)	450 (230)	8 x 10.5	0.6	300
150	151	8 x 10.5 (6.3 x 7.7)	0.3 (0.6)	450 (230)	8 x 10.5	0.3	450	10 x 10.5		500
								Case size ∅D x L (mm) 尺寸	Impedance (Ω) at 20°C, 100KHz 阻抗值	Ripple current (mA rms) at 105°C, 100KHz 紋波電流

Note: All design and specifications are for reference only and is subject to change without prior notice. If any doubt about safety for your application, please contact us immediately for technical assistance before purchase.

注：以上所提供的設計及特性參數僅供參考，任何修改不作預先通知。如果在使用上有疑問，請在採購前與我們聯繫，以便提供技術上的協助。

CAT.2023/V2

LZ Series

□ DIMENSIONS & MAXIMUM PERMISSIBLE RIPPLE CURRENT & IMPEDANCE 規格尺寸及最大允許紋波電流及阻抗值

WV		25			35			50		
Code	代碼	1E			1V			1H		
μF										
220	221	8 × 10.5	0.3	450	10 × 10.5 (8 × 10.5)	0.15 (0.3)	670 (450)	10 × 10.5	0.3	500
330	331	10 × 10.5 (8 × 10.5)	0.15 (0.3)	670 (450)	10 × 10.5	0.15	670	16 × 16.5 (12.5 × 13.5) (10 × 13.5)	0.12 (0.2) (0.25)	1060 (650) (580)
470	471	10 × 10.5	0.15	670	10 × 13.5 (10 × 10.5)	0.13 (0.15)	750 (670)	16 × 16.5 (12.5 × 16)	0.12 (0.15)	1060 (700)
680	681	10 × 13.5	0.13	750	12.5 × 13.5 (10 × 13.5)	0.11 (0.13)	820 (750)	16 × 16.5	0.12	1060
1000	102	16 × 16.5 (12.5 × 13.5)	0.08 (0.11)	1260 (820)	16 × 16.5 (12.5 × 16)	0.08 (0.09)	1260 (950)			
1500	152	12.5 × 16	0.09	950	16 × 16.5	0.08	1260	Case size ∅D×L(mm) 尺寸	Impedance (Ω) at 20°C, 100KHz 阻抗值	Ripple current (mA rms) at 105°C, 100KHz 紋波電流
2200	222	16 × 16.5	0.08	1260						

WV		63			80			100		
Code	代碼	1J			1K			2A		
μF										
10	100	6.3 × 7.7	1.5	95				6.3 × 7.7	4.0	65
22	220	6.3 × 7.7	1.0	130	6.3 × 7.7	2.0	130			
47	470	8 × 10.5	0.65	250				10 × 10.5	0.65	350
100	470	10 × 10.5	0.50	430				12.5 × 13.5	0.60	500
220	680	12.5 × 13.5	0.30	550				Case size ∅D×L(mm) 尺寸	Impedance (Ω) at 20°C, 100KHz 阻抗值	Ripple current (mA rms) at 105°C, 100KHz 紋波電流

□ FREQUENCY COEFFICIENT OF ALLOWABLE RIPPLE CURRENT 紋波電流頻率補償系數

Frequency 頻率		50Hz	120Hz	300Hz	1KHz	10KHz~
Coefficient 系數	∅4 ~ ∅10	1 ~ 68μF	0.35	0.50	0.64	0.83
		100 ~ 2200μF	0.40	0.55	0.70	0.85
	∅12.5 ~ ∅16	~ 680μF	0.45	0.65	0.80	0.90
		1000 ~ 4700μF	0.65	0.85	0.95	1.00

The endurance of capacitors is reduced with internal heating produced by ripple current at the rate of halving the lifetime with every 5~10°C rise. When long life performance is required in actual use, the rms ripple current has to be reduced. 鋁電解電容器在疊加紋波電流後會引起發熱，溫度每上升 5~10°C 壽命會減半。若要保持長壽命性能，請在使用過程中適當降低紋波電流。

- Taping specifications are given in page 17. 編帶標準請查閱第 17 頁。
- Soldering conditions and recommended land size are given in page 23. 焊接條件及推薦安裝尺寸請查閱第 23 頁。
- Please refer to page 18 for the minimum package quantity. 最小包裝數量請查閱第 18 頁。
- Please refer to page 15 for the Part Number System. 產品編碼規則請查閱第 15 頁。

Note: All design and specifications are for reference only and is subject to change without prior notice. If any doubt about safety for your application, please contact us immediately for technical assistance before purchase.

注：以上所提供的設計及特性參數僅供參考，任何修改不作預先通知。如果在使用上有疑問，請在採購前與我們聯繫，以便提供技術上的協助。

CAT.2023/V2

KZ Series

CHIP TYPE, EXTRA LOWER IMPEDANCE

貼片式，極低阻抗品

- Extra low impedance
極低阻抗
- Impedance 40~60% less than LZ series
阻抗值比 LZ 系列低 40~60%
- RoHS & REACH compliant, Halogen-free
符合 RoHS 與 REACH，無鹵

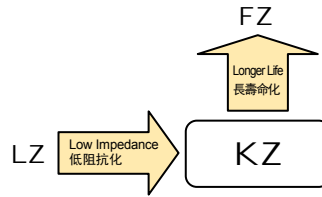

□ SPECIFICATIONS 特性表

Items 項目	Characteristics 主要特性																																	
Category Temperature Range 工作溫度範圍	-55 ~ +105°C																																	
Voltage Range 額定工作電壓範圍	6.3 ~ 100V																																	
Capacitance Range 靜電容量範圍	4.7 ~ 4700µF																																	
Capacitance Tolerance 靜電容量允許偏差	±20% at 120Hz, 20°C																																	
Leakage Current 漏電流	Leakage current ≤0.01CV or 3µA (∅4~∅10), whichever is greater (after 2 minutes application of rated voltage at 20°C) Leakage current ≤0.03CV or 4µA (∅12.5~∅16), whichever is greater (after 1 minute application of rated voltage at 20°C) 漏電流 ≤0.01CV 或 3µA (∅4~∅10)，取較大值（在 20°C 環境中施加額定工作電壓 2 分鐘後） 漏電流 ≤0.03CV 或 4µA (∅12.5~∅16)，取較大值（在 20°C 環境中施加額定工作電壓 1 分鐘後） C: Nominal capacitance (µF) 標稱靜電容量, V: Rated voltage (V) 額定電壓																																	
Dissipation Factor (tan δ) 損耗角正切	Measurement frequency 測試頻率: 120Hz, Temperature 溫度: 20°C <table border="1"> <tr> <td>Rated Voltage (V) 額定工作電壓</td> <td>6.3</td> <td>10</td> <td>16</td> <td>25</td> <td>35</td> <td>50</td> <td>100</td> </tr> <tr> <td>tan δ (max.)</td> <td>∅4~∅10</td> <td>0.22</td> <td>0.19</td> <td>0.16</td> <td>0.14</td> <td>0.12</td> <td>0.10</td> </tr> <tr> <td>最大損耗角正切</td> <td>∅12.5~∅16</td> <td>0.26</td> <td>0.22</td> <td>0.18</td> <td>0.16</td> <td>0.14</td> <td>0.10</td> </tr> </table>	Rated Voltage (V) 額定工作電壓	6.3	10	16	25	35	50	100	tan δ (max.)	∅4~∅10	0.22	0.19	0.16	0.14	0.12	0.10	最大損耗角正切	∅12.5~∅16	0.26	0.22	0.18	0.16	0.14	0.10									
Rated Voltage (V) 額定工作電壓	6.3	10	16	25	35	50	100																											
tan δ (max.)	∅4~∅10	0.22	0.19	0.16	0.14	0.12	0.10																											
最大損耗角正切	∅12.5~∅16	0.26	0.22	0.18	0.16	0.14	0.10																											
Stability at Low Temperature 低溫特性	Measurement frequency 測試頻率: 120Hz <table border="1"> <tr> <td>Rated Voltage (V) 額定工作電壓</td> <td>6.3</td> <td>10</td> <td>16</td> <td>25</td> <td>35~100</td> </tr> <tr> <td rowspan="2">Impedance Ratio 阻抗比</td> <td rowspan="2">∅4~∅10</td> <td>Z(-25°C) / Z(20°C)</td> <td>2</td> <td>2</td> <td>2</td> <td>2</td> </tr> <tr> <td>Z(-55°C) / Z(20°C)</td> <td>5</td> <td>4</td> <td>4</td> <td>3</td> <td>3</td> </tr> <tr> <td rowspan="2">ZT/Z20 (max.)</td> <td rowspan="2">∅12.5~∅16</td> <td>Z(-25°C) / Z(20°C)</td> <td>3</td> <td>3</td> <td>2</td> <td>2</td> <td>2</td> </tr> <tr> <td>Z(-55°C) / Z(20°C)</td> <td>10</td> <td>8</td> <td>6</td> <td>4</td> <td>3</td> </tr> </table>	Rated Voltage (V) 額定工作電壓	6.3	10	16	25	35~100	Impedance Ratio 阻抗比	∅4~∅10	Z(-25°C) / Z(20°C)	2	2	2	2	Z(-55°C) / Z(20°C)	5	4	4	3	3	ZT/Z20 (max.)	∅12.5~∅16	Z(-25°C) / Z(20°C)	3	3	2	2	2	Z(-55°C) / Z(20°C)	10	8	6	4	3
Rated Voltage (V) 額定工作電壓	6.3	10	16	25	35~100																													
Impedance Ratio 阻抗比	∅4~∅10	Z(-25°C) / Z(20°C)	2	2	2	2																												
		Z(-55°C) / Z(20°C)	5	4	4	3	3																											
ZT/Z20 (max.)	∅12.5~∅16	Z(-25°C) / Z(20°C)	3	3	2	2	2																											
		Z(-55°C) / Z(20°C)	10	8	6	4	3																											
Endurance 耐久性	After 3000 hrs. (2000 hrs. for ∅4~∅8) application of the rated voltage at 105°C, they meet the characteristics listed below. 在 105°C 環境中施加額定工作電壓 3000 小時 (∅4~∅8 為 2000 小時) 後，電容器的特性符合下表的要求。 <table border="1"> <tr> <td>Capacitance Change 靜電容量變化率</td> <td>Within ±25% of initial value 初始值的±25%以內</td> </tr> <tr> <td>Dissipation Factor 損耗角正切</td> <td>200% or less of initial specified value 不大於規範值的 200%</td> </tr> <tr> <td>Leakage Current 漏電流</td> <td>initial specified value or less 不大於規範值</td> </tr> </table>	Capacitance Change 靜電容量變化率	Within ±25% of initial value 初始值的±25%以內	Dissipation Factor 損耗角正切	200% or less of initial specified value 不大於規範值的 200%	Leakage Current 漏電流	initial specified value or less 不大於規範值																											
Capacitance Change 靜電容量變化率	Within ±25% of initial value 初始值的±25%以內																																	
Dissipation Factor 損耗角正切	200% or less of initial specified value 不大於規範值的 200%																																	
Leakage Current 漏電流	initial specified value or less 不大於規範值																																	
Shelf Life 高溫貯存特性	After leaving capacitors under no load at 105°C for 1000 hours, they meet the specified value for load life characteristics listed above. 在 105°C 環境中無負荷放置 1000 小時後，電容器的特性符合高溫負荷特性中所列的規定值。																																	
Resistance to Soldering Heat 耐焊接熱特性 (Please refer page 23 for soldering conditions) (焊接條件請查閱第 23 頁)	After reflow soldering and restored at room temperature, they meet the characteristics listed below. 經過回流焊並冷卻至室溫後，電容器的特性符合下表的要求。 <table border="1"> <tr> <td>Capacitance Change 靜電容量變化率</td> <td>Within ±10% of initial value 初始值的±10%以內</td> </tr> <tr> <td>Dissipation Factor 損耗角正切</td> <td>initial specified value or less 不大於規範值</td> </tr> <tr> <td>Leakage Current 漏電流</td> <td>initial specified value or less 不大於規範值</td> </tr> </table>	Capacitance Change 靜電容量變化率	Within ±10% of initial value 初始值的±10%以內	Dissipation Factor 損耗角正切	initial specified value or less 不大於規範值	Leakage Current 漏電流	initial specified value or less 不大於規範值																											
Capacitance Change 靜電容量變化率	Within ±10% of initial value 初始值的±10%以內																																	
Dissipation Factor 損耗角正切	initial specified value or less 不大於規範值																																	
Leakage Current 漏電流	initial specified value or less 不大於規範值																																	
Marking 標識	Black print on the case top. 鋁殼頂部黑字印刷。																																	

□ DRAWING 外形圖 (Unit: mm)

(∅4~∅6.3×7.7)

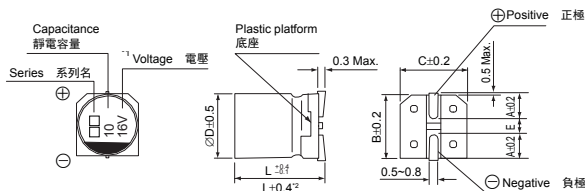

(∅8×10.5~∅16)

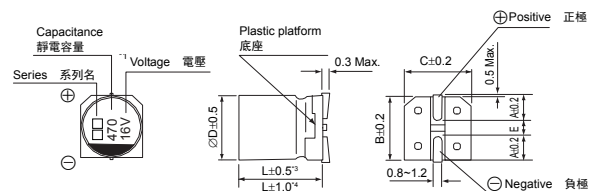

- *1. Voltage mark for 6.3V is [6V]
- *2. Applicable to ∅6.3×7.7
- *3. Applicable to ∅8×10.5~∅10
- *4. Applicable to ∅12.5~∅16

- 6.3V 的產品標識為 [6V]
- 適用於∅6.3×7.7
- 適用於∅8×10.5~∅10
- 適用於∅12.5~∅16

Dimension table in next page.
尺寸表見下一頁。

Note: All design and specifications are for reference only and is subject to change without prior notice. If any doubt about safety for your application, please contact us immediately for technical assistance before purchase.

注: 以上所提供的設計及特性參數僅供參考，任何修改不作預先通知。如果在使用上有疑問，請在採購前與我們聯繫，以便提供技術上的協助。

CAT.2023/V2

KZ Series

□ DIMENSIONS (Unit: mm) 尺寸表

∅D x L	4 x 5.8	5 x 5.8	6.3 x 5.8	6.3 x 7.7	8 x 10.5	10 x 10.5	10 x 13.5	12.5 x 13.5	12.5 x 16	16 x 16.5
A	2.0	2.2	2.6	2.6	3.0	3.3	3.3	4.9	4.9	5.8
B	4.3	5.3	6.6	6.6	8.4	10.4	10.4	13.0	13.0	17.0
C	4.3	5.3	6.6	6.6	8.4	10.4	10.4	13.0	13.0	17.0
E ± 0.2	1.0	1.4	1.9	1.9	3.1	4.7	4.7	4.7	4.7	6.4
L	5.8	5.8	5.8	7.7	10.5	10.5	13.5	13.5	16.0	16.5

□ DIMENSIONS & MAXIMUM PERMISSIBLE RIPPLE CURRENT & IMPEDANCE 規格尺寸及最大允許紋波電流及阻抗值

μF	WV Code 代碼	6.3			10			16		
		0J			1A			1C		
10	100							4 x 5.8	1.8	80
15	150							4 x 5.8	1.8	80
22	220	4 x 5.8	1.8	80	4 x 5.8	1.8	80	5 x 5.8 (4 x 5.8)	0.76 (1.8)	150 (80)
33	330	5 x 5.8 (4 x 5.8)	0.76 (1.8)	150 (80)	5 x 5.8 (4 x 5.8)	0.76 (1.8)	150 (80)	6.3 x 5.8 (5 x 5.8)	0.44 (0.76)	230 (150)
47	470	5 x 5.8 (4 x 5.8)	0.76 (1.8)	150 (80)	6.3 x 5.8 (5 x 5.8)	0.44 (0.76)	230 (150)	6.3 x 5.8 (5 x 5.8)	0.44 (0.76)	230 (150)
56	560	5 x 5.8	0.76	150	6.3 x 5.8	0.44	230	6.3 x 5.8	0.44	230
68	680	6.3 x 5.8 (5 x 5.8)	0.44 (0.76)	230 (150)	6.3 x 5.8	0.44	230	6.3 x 7.7 (6.3 x 5.8)	0.34 (0.44)	280 (230)
100	101	6.3 x 5.8 (5 x 5.8)	0.44 (0.76)	230 (150)	6.3 x 7.7 (6.3 x 5.8)	0.34 (0.44)	280 (230)	6.3 x 7.7 (6.3 x 5.8)	0.34 (0.44)	280 (230)
150	151	6.3 x 5.8	0.44	230	6.3 x 7.7	0.34	280	6.3 x 7.7	0.34	280
220	221	6.3 x 7.7 (6.3 x 5.8)	0.34 (0.44)	280 (230)	6.3 x 7.7	0.34	280	8 x 10.5 (6.3 x 7.7)	0.17 (0.34)	450 (280)
330	331	6.3 x 7.7	0.34	280	8 x 10.5	0.17	450	10 x 10.5 (8 x 10.5)	0.09 (0.17)	670 (450)
470	471	8 x 10.5	0.17	450	8 x 10.5	0.17	450	10 x 10.5 (8 x 10.5)	0.09 (0.17)	670 (450)
680	681	10 x 10.5 (8 x 10.5)	0.09 (0.17)	670 (450)	10 x 10.5	0.09	670	10 x 13.5 (10 x 10.5)	0.075 (0.09)	800 (670)
1000	102	10 x 10.5 (8 x 10.5)	0.09 (0.17)	670 (450)	10 x 10.5	0.09	670	16 x 16.5 (12.5 x 16) (12.5 x 13.5)	0.055 (0.06) (0.065)	1350 (1050) (900)
1500	152	10 x 13.5 (10 x 10.5)	0.075 (0.09)	800 (670)	12.5 x 13.5	0.065	900	16 x 16.5	0.055	1350
2200	222	12.5 x 13.5	0.065	900	12.5 x 16	0.06	1050	16 x 16.5	0.055	1350
3300	332	12.5 x 16	0.06	1050	16 x 16.5	0.055	1350	Case size ∅D x L (mm) 尺寸	Impedance (Ω) at 20°C, 100KHz 阻抗值	Ripple current (mA rms) at 105°C, 100KHz 紋波電流
4700	472	16 x 16.5	0.055	1350						

μF	WV Code 代碼	25			35			50		
		1E			1V			1H		
4.7	4R7				4 x 5.8	1.8	80	5 x 5.8 (4 x 5.8)	1.52 (3.0)	85 (60)
10	100	4 x 5.8	1.8	80	5 x 5.8 (4 x 5.8)	0.76 (1.8)	150 (80)	6.3 x 5.8 (5 x 5.8)	0.88 (1.52)	165 (85)
15	150	5 x 5.8	0.76	150	5 x 5.8	0.76	150	6.3 x 5.8	0.88	165
22	220	6.3 x 5.8 (5 x 5.8)	0.44 (0.76)	230 (150)	6.3 x 5.8 (5 x 5.8)	0.44 (0.76)	230 (150)	6.3 x 7.7 (6.3 x 5.8)	0.68 (0.88)	185 (165)
33	330	6.3 x 5.8 (5 x 5.8)	0.44 (0.76)	230 (150)	6.3 x 5.8	0.44	230	6.3 x 7.7	0.68	185
47	470	6.3 x 7.7 (6.3 x 5.8)	0.34 (0.44)	280 (230)	6.3 x 7.7 (6.3 x 5.8)	0.34 (0.44)	280 (230)	6.3 x 7.7	0.68	185
56	560	6.3 x 7.7 (6.3 x 5.8)	0.34 (0.44)	280 (230)	6.3 x 7.7	0.34	280	8 x 10.5 (6.3 x 7.7)	0.34 (0.68)	350 (185)
68	680	6.3 x 7.7	0.34	280	6.3 x 7.7	0.34	280	8 x 10.5	0.34	350
100	101	6.3 x 7.7	0.34	280	8 x 10.5	0.17	450	10 x 10.5 (8 x 10.5)	0.18 (0.34)	670 (350)
150	151	8 x 10.5 (6.3 x 7.7)	0.17 (0.34)	450 (280)	10 x 10.5 (8 x 10.5)	0.09 (0.17)	670 (450)	10 x 10.5	0.18	670
								Case size ∅D x L (mm) 尺寸	Impedance (Ω) at 20°C, 100KHz 阻抗值	Ripple current (mA rms) at 105°C, 100KHz 紋波電流

Note: All design and specifications are for reference only and is subject to change without prior notice. If any doubt about safety for your application, please contact us immediately for technical assistance before purchase.

注：以上所提供的設計及特性參數僅供參考，任何修改不作預先通知。如果在使用上有疑問，請在採購前與我們聯繫，以便提供技術上的協助。

CAT.2023/V2

KZ Series

□ DIMENSIONS & MAXIMUM PERMISSIBLE RIPPLE CURRENT & IMPEDANCE 規格尺寸及最大允許紋波電流及阻抗值

WV		25			35			50		
μF	Code 代碼	1E			1V			1H		
220	221	8 × 10.5	0.17	450	10 × 10.5 (8 × 10.5)	0.09 (0.17)	670 (450)	10 × 13.5 (10 × 10.5)	0.16 (0.18)	750 (670)
330	331	10 × 10.5 (8 × 10.5)	0.09 (0.17)	670 (450)	10 × 10.5	0.09	670	12.5 × 13.5	0.14	800
470	471	10 × 13.5 (10 × 10.5)	0.075 (0.09)	800 (670)	12.5 × 13.5 (10 × 13.5)	0.065 (0.075)	900 (800)	16 × 16.5 (12.5 × 16)	0.10 (0.12)	1150 (900)
680	681	12.5 × 13.5	0.065	900	12.5 × 16 (12.5 × 13.5)	0.060 (0.065)	1050 (900)			
1000	102	16 × 16.5 (12.5 × 16)	0.055 (0.060)	1350 (1050)	16 × 16.5	0.055	1350	Case size ∅D×L(mm) 尺寸	Impedance (Ω) at 20°C, 100KHz 阻抗值	Ripple current (mA rms) at 105°C, 100KHz 紋波電流
1500	152	16 × 16.5	0.055	1350						

WV		100		
μF	Code 代碼	2A		
10	100	8 × 10.5	1.8	110
		Case size ∅D×L(mm) 尺寸	Impedance (Ω) at 20°C, 100KHz 阻抗值	Ripple current (mA rms) at 105°C, 100KHz 紋波電流

□ FREQUENCY COEFFICIENT OF ALLOWABLE RIPPLE CURRENT 紋波電流頻率補償系數

Frequency 頻率		50Hz	120Hz	300Hz	1KHz	10KHz~
Coefficient 系數	∅4 ~ ∅10	4.7 ~ 68μF	0.35	0.50	0.64	0.83
		100 ~ 1500μF	0.40	0.55	0.70	0.85
	∅12.5 ~ ∅16	~ 680μF	0.45	0.65	0.80	0.90
		1000 ~ 4700μF	0.65	0.85	0.95	1.00

The endurance of capacitors is reduced with internal heating produced by ripple current at the rate of halving the lifetime with every 5~10°C rise. When long life performance is required in actual use, the rms ripple current has to be reduced. 鋁電解電容器在疊加紋波電流後會引起發熱，溫度每上升 5~10°C 壽命會減半。若要保持長壽命性能，請在使用過程中適當降低紋波電流。

- Taping specifications are given in page 17. 編帶標準請查閱第 17 頁。
- Soldering conditions and recommended land size are given in page 23. 焊接條件及推薦安裝尺寸請查閱第 23 頁。
- Please refer to page 18 for the minimum package quantity. 最小包裝數量請查閱第 18 頁。
- Please refer to page 15 for the Part Number System. 產品編碼規則請查閱第 15 頁。

Note: All design and specifications are for reference only and is subject to change without prior notice. If any doubt about safety for your application, please contact us immediately for technical assistance before purchase.

注：以上所提供的設計及特性參數僅供參考，任何修改不作預先通知。如果在使用上有疑問，請在採購前與我們聯繫，以便提供技術上的協助。

CAT.2023/V2

FZ Series

CHIP TYPE, LONG LIFE WITH EXTRA LOWER IMPEDANCE

貼片式，長壽命極低阻抗品



- Extra lower impedance
極低阻抗
- Endurance 2000~5000 hours
耐久性 2000~5000 小時
- Impedance 5~25% less than KZ series
阻抗值比 KZ 系列低 5~25%
- RoHS & REACH compliant, Halogen-free
符合 RoHS 與 REACH，無鹵
- AEC-Q200 compliant (Please contact us for details)
符合 AEC-Q200 (請與我們聯繫瞭解詳細信息)

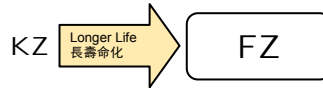

□ SPECIFICATIONS 特性表

Items 項目	Characteristics 主要特性																											
Category 工作溫度範圍	-55 ~ +105°C																											
Voltage Range 額定工作電壓範圍	6.3 ~ 100V																											
Capacitance Range 靜電容量範圍	3.3 ~ 8200µF																											
Capacitance Tolerance 靜電容量允許偏差	±20% at 120Hz, 20°C																											
Leakage Current 漏電流	Leakage current ≤0.01CV or 3µA (∅4~∅10), whichever is greater (after 2 minutes application of rated voltage at 20°C) Leakage current ≤0.03CV or 4µA (∅12.5~∅18), whichever is greater (after 1 minute application of rated voltage at 20°C) 漏電流 ≤0.01CV 或 3µA (∅4~∅10)，取較大值 (在 20°C 環境中施加額定工作電壓 2 分鐘後) 漏電流 ≤0.03CV 或 4µA (∅12.5~∅18)，取較大值 (在 20°C 環境中施加額定工作電壓 1 分鐘後) C: Nominal capacitance (µF) 標稱靜電容量, V: Rated voltage (V) 額定電壓																											
Dissipation Factor (tan δ) 損耗角正切	Measurement frequency 測試頻率: 120Hz, Temperature 溫度: 20°C <table border="1"> <thead> <tr> <th>Rated Voltage (V) 額定工作電壓</th> <th>6.3</th> <th>10</th> <th>16</th> <th>25</th> <th>35</th> <th>50</th> <th>63~80</th> <th>100</th> </tr> </thead> <tbody> <tr> <td>tan δ (max.)</td> <td>∅4~∅10</td> <td>0.26</td> <td>0.19</td> <td>0.16</td> <td>0.14</td> <td>0.12</td> <td>0.10</td> <td>0.08</td> </tr> <tr> <td>最大損耗角正切</td> <td>∅12.5~∅18</td> <td>0.26</td> <td>0.19</td> <td>0.18</td> <td>0.16</td> <td>0.14</td> <td>0.10</td> <td>0.08</td> </tr> </tbody> </table>	Rated Voltage (V) 額定工作電壓	6.3	10	16	25	35	50	63~80	100	tan δ (max.)	∅4~∅10	0.26	0.19	0.16	0.14	0.12	0.10	0.08	最大損耗角正切	∅12.5~∅18	0.26	0.19	0.18	0.16	0.14	0.10	0.08
Rated Voltage (V) 額定工作電壓	6.3	10	16	25	35	50	63~80	100																				
tan δ (max.)	∅4~∅10	0.26	0.19	0.16	0.14	0.12	0.10	0.08																				
最大損耗角正切	∅12.5~∅18	0.26	0.19	0.18	0.16	0.14	0.10	0.08																				
Stability at Low Temperature 低溫特性	Measurement frequency 測試頻率: 120Hz <table border="1"> <thead> <tr> <th>Rated Voltage (V) 額定工作電壓</th> <th>6.3~16</th> <th>25~100</th> </tr> </thead> <tbody> <tr> <td>Impedance Ratio 阻抗比</td> <td>Z(-25°C) / Z(20°C)</td> <td>2</td> </tr> <tr> <td>ZT/Z20 (max.)</td> <td>Z(-40°C) / Z(20°C)</td> <td>3</td> </tr> <tr> <td></td> <td>Z(-55°C) / Z(20°C)</td> <td>4</td> </tr> </tbody> </table>	Rated Voltage (V) 額定工作電壓	6.3~16	25~100	Impedance Ratio 阻抗比	Z(-25°C) / Z(20°C)	2	ZT/Z20 (max.)	Z(-40°C) / Z(20°C)	3		Z(-55°C) / Z(20°C)	4															
Rated Voltage (V) 額定工作電壓	6.3~16	25~100																										
Impedance Ratio 阻抗比	Z(-25°C) / Z(20°C)	2																										
ZT/Z20 (max.)	Z(-40°C) / Z(20°C)	3																										
	Z(-55°C) / Z(20°C)	4																										
Endurance 耐久性	After 5000 hrs. (2000 hrs. for ∅4~∅6.3×5.8) application of the rated voltage at 105°C, they meet the characteristics listed below. 在 105°C 環境中施加額定工作電壓 5000 小時 (∅4~∅6.3×5.8 為 2000 小時) 後，電容器的特性符合下表的要求。 <table border="1"> <tbody> <tr> <td>Capacitance Change 靜電容量變化率</td> <td>Within ±30% of initial value 初始值的±30%以內</td> </tr> <tr> <td>Dissipation Factor 損耗角正切</td> <td>200% or less of initial specified value 不大於規範值的 200%</td> </tr> <tr> <td>Leakage Current 漏電流</td> <td>initial specified value or less 不大於規範值</td> </tr> </tbody> </table>	Capacitance Change 靜電容量變化率	Within ±30% of initial value 初始值的±30%以內	Dissipation Factor 損耗角正切	200% or less of initial specified value 不大於規範值的 200%	Leakage Current 漏電流	initial specified value or less 不大於規範值																					
Capacitance Change 靜電容量變化率	Within ±30% of initial value 初始值的±30%以內																											
Dissipation Factor 損耗角正切	200% or less of initial specified value 不大於規範值的 200%																											
Leakage Current 漏電流	initial specified value or less 不大於規範值																											
Shelf Life 高溫貯存特性	After leaving capacitors under no load at 105°C for 1000 hours, they meet the specified value for load life characteristics listed above. 在 105°C 環境中無負荷放置 1000 小時後，電容器的特性符合高溫負荷特性中所列的規定值。																											
Resistance to Soldering Heat 耐焊接熱特性 (Please refer page 23 for soldering conditions) (焊接條件請查閱第 23 頁)	After reflow soldering and restored at room temperature, they meet the characteristics listed below. 經過回流焊並冷卻至室溫後，電容器的特性符合下表的要求。 <table border="1"> <tbody> <tr> <td>Capacitance Change 靜電容量變化率</td> <td>Within ±10% of initial value 初始值的±10%以內</td> </tr> <tr> <td>Dissipation Factor 損耗角正切</td> <td>initial specified value or less 不大於規範值</td> </tr> <tr> <td>Leakage Current 漏電流</td> <td>initial specified value or less 不大於規範值</td> </tr> </tbody> </table>	Capacitance Change 靜電容量變化率	Within ±10% of initial value 初始值的±10%以內	Dissipation Factor 損耗角正切	initial specified value or less 不大於規範值	Leakage Current 漏電流	initial specified value or less 不大於規範值																					
Capacitance Change 靜電容量變化率	Within ±10% of initial value 初始值的±10%以內																											
Dissipation Factor 損耗角正切	initial specified value or less 不大於規範值																											
Leakage Current 漏電流	initial specified value or less 不大於規範值																											
Marking 標識	Black print on the case top. 鋁殼頂部黑字印刷。																											

□ DRAWING 外形圖 (Unit: mm)

(∅4~∅6.3×7.7)

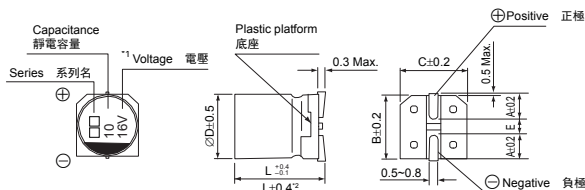

(∅8×10.5~∅18)

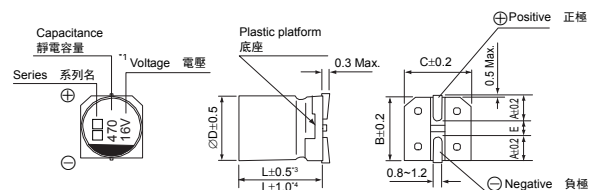

*1. Voltage mark for 6.3V is [6V]
*2. Applicable to ∅6.3×7.7
*3. Applicable to ∅8×10.5~∅10
*4. Applicable to ∅12.5~∅18

6.3V 的產品標識為 [6V]
適用於 ∅6.3×7.7
適用於 ∅8×10.5~∅10
適用於 ∅12.5~∅18

Dimension table in next page.
尺寸表見下一頁。

Note: All design and specifications are for reference only and is subject to change without prior notice. If any doubt about safety for your application, please contact us immediately for technical assistance before purchase.

注: 以上所提供的設計及特性參數僅供參考，任何修改不作預先通知。如果在使用上有疑問，請在採購前與我們聯繫，以便提供技術上的協助。

CAT.2023/V2

FZ Series

□ DIMENSIONS (Unit: mm) 尺寸表

∅D x L	4 x 5.8	5 x 5.8	6.3 x 5.8/7.7	8 x 10.5	10 x 10.5/13.5	12.5 x 13.5/16.0	16 x 16.5	18 x 16.5/18.5
A	2.0	2.2	2.6	3.0	3.3	4.9	5.8	6.2
B	4.3	5.3	6.6	8.4	10.4	13.0	17.0	19.0
C	4.3	5.3	6.6	8.4	10.4	13.0	17.0	19.0
E ± 0.2	1.0	1.4	1.9	3.1	4.7	4.7	6.4	6.4
L	5.8	5.8	5.8/7.7	10.5	10.5/13.5	13.5/16.0	16.5	16.5/18.5

□ DIMENSIONS & MAXIMUM PERMISSIBLE RIPPLE CURRENT & IMPEDANCE 規格尺寸及最大允許紋波電流及阻抗值

WV μF		6.3			10			16		
		0J			1A			1C		
10	100							4 x 5.8	1.35	90
15	150							4 x 5.8	1.35	90
22	220	4 x 5.8	1.35	90	4 x 5.8	1.35	90	5 x 5.8	0.76	160
33	330	5 x 5.8 (4 x 5.8)	0.76 (1.35)	160 (90)	5 x 5.8	0.76	160	6.3 x 5.8	0.44	240
47	470	5 x 5.8 (4 x 5.8)	0.76 (1.35)	160 (90)	6.3 x 5.8	0.44	240	6.3 x 5.8 (5 x 5.8)	0.44 (0.76)	240 (160)
56	560	5 x 5.8	0.76	160	6.3 x 5.8	0.44	240	6.3 x 5.8	0.44	240
68	680	6.3 x 5.8	0.44	240	6.3 x 5.8	0.44	240	6.3 x 7.7 (6.3 x 5.8)	0.34 (0.44)	300 (240)
100	101	6.3 x 5.8	0.44	240	6.3 x 7.7	0.34	300	6.3 x 7.7 (6.3 x 5.8)	0.34 (0.44)	300 (240)
150	151	6.3 x 5.8	0.44	240	6.3 x 7.7	0.34	300	6.3 x 7.7	0.34	300
220	221	6.3 x 7.7 (6.3 x 5.8)	0.34 (0.44)	300 (240)	6.3 x 7.7	0.34	300	8 x 10.5 (6.3 x 7.7)	0.17 (0.34)	600 (300)
330	331	8 x 10.5	0.17	600	10 x 10.5 (8 x 10.5)	0.09 (0.17)	850 (600)	10 x 10.5 (8 x 10.5)	0.08 (0.17)	850 (600)
470	471	8 x 10.5	0.17	600	10 x 10.5 (8 x 10.5)	0.09 (0.17)	850 (600)	10 x 10.5 (8 x 10.5)	0.09 (0.17)	850 (600)
680	681	10 x 10.5 (8 x 10.5)	0.09 (0.17)	850 (600)	10 x 10.5	0.09	850	10 x 13.5 (10 x 10.5)	0.07 (0.09)	950 (850)
1000	102	10 x 10.5 (8 x 10.5)	0.09 (0.17)	850 (600)	10 x 13.5 (10 x 10.5)	0.07 (0.09)	950 (850)	12.5 x 16 (12.5 x 13.5)	0.055 (0.06)	1200 (1100)
1500	152	10 x 13.5	0.09	950	12.5 x 13.5	0.06	1100	16 x 16.5	0.05	1450
2200	222	12.5 x 13.5	0.06	1100	12.5 x 16	0.055	1200	16 x 16.5	0.05	1450
3300	332	12.5 x 16 (12.5 x 13.5)	0.055 (0.06)	1200 (1100)	16 x 16.5	0.05	1260	16 x 16.5	0.05	1450
4700	472	16 x 16.5	0.05	1450	16 x 16.5	0.05	1450	18 x 16.5	0.048	1500
6800	682	18 x 16.5	0.048	1500	18 x 16.5	0.048	1500	Case size 尺寸	Impedance 阻抗值	Ripple current 紋波電流
8200	822	18 x 16.5	0.048	1500						

WV μF		25			35			50		
		1E			1V			1H		
4.7	4R7				4 x 5.8	1.35	90	5 x 5.8	1.52	85
10	100	4 x 5.8	1.35	90	5 x 5.8	0.76	160	6.3 x 5.8 (5 x 5.8)	0.88 (1.35)	165 (115)
15	150	5 x 5.8	0.76	160	5 x 5.8	0.76	160	6.3 x 5.8	0.88	165
22	220	6.3 x 5.8 (5 x 5.8)	0.44 (0.76)	240 (160)	6.3 x 5.8	0.44	240	6.3 x 7.7 (6.3 x 5.8)	0.68 (0.88)	195 (165)
33	330	6.3 x 5.8	0.44	240	6.3 x 5.8	0.44	240	6.3 x 7.7	0.68	195
47	470	6.3 x 7.7 (6.3 x 5.8)	0.34 (0.44)	300 (240)	6.3 x 7.7 (6.3 x 5.8)	0.34 (0.88)	300 (165)	8 x 10.5 (6.3 x 7.7)	0.34 (0.68)	350 (195)
56	560	6.3 x 7.7	0.34	300	6.3 x 7.7	0.34	300	8 x 10.5	0.34	350
68	680	6.3 x 7.7	0.34	300	8 x 10.5	0.17	600	8 x 10.5	0.34	350
100	101	8 x 10.5 (6.3 x 7.7)	0.17 (0.34)	600 (300)	8 x 10.5	0.17	600	10 x 10.5 (8 x 10.5)	0.18 (0.34)	670 (350)
150	151	8 x 10.5 (6.3 x 7.7)	0.16 (0.34)	600 (300)	10 x 10.5 (8 x 10.5)	0.09 (0.17)	850 (600)	10 x 13.5 (10 x 10.5)	0.14 (0.18)	780 (670)
220	221	8 x 10.5	0.17	600	10 x 10.5 (8 x 10.5)	0.09 (0.16)	850 (600)	10 x 13.5 (10 x 10.5)	0.14 (0.26)	780 (750)
330	331	10 x 10.5 (8 x 10.5)	0.09 (0.17)	850 (600)	10 x 13.5 (10 x 10.5)	0.07 (0.10)	950 (850)	12.5 x 13.5	0.12	900
470	471	10 x 13.5 (10 x 10.5)	0.07 (0.09)	950 (850)	12.5 x 13.5 (10 x 13.5) (10 x 10.5)	0.06 (0.07) (0.10)	1100 (1000) (950)	16 x 16.5 (12.5 x 16) (12.5 x 13.5)	0.08 (0.10) (0.08)	1250 (1050) (1100)
680	681	12.5 x 13.5	0.06	1100	12.5 x 16 (12.5 x 13.5)	0.055 (0.06)	1200 (1100)	16 x 16.5	0.073	1250
1000	102	16 x 16.5 (12.5 x 16) (12.5 x 13.5)	0.05 (0.055) (0.06)	1450 (1200) (1100)	16 x 16.5	0.05	1450	18 x 18.5 (16 x 16.5) (18 x 16.5)	0.073 (0.08) (0.073)	1250 (1000) (1250)
1500	152	16 x 16.5	0.05	1450	16 x 16.5	0.048	1500	18 x 16.5	0.066	1500
2200	222	16 x 16.5	0.05	1450	18 x 18.5	0.038	1750	Case size 尺寸	Impedance 阻抗值	Ripple current 紋波電流
3300	333	18 x 16.5 (18 x 18.5)	0.048 (0.048)	1500 (1500)						

•Case size 尺寸 ∅D×L(mm), Impedance 阻抗值 (Ω) at 20°C, 100KHz, Ripple current 紋波電流 (mA rms) at 105°C, 100KHz

Note: All design and specifications are for reference only and is subject to change without prior notice. If any doubt about safety for your application, please contact us immediately for technical assistance before purchase.

注：以上所提供的設計及特性參數僅供參考，任何修改不作預先通知。如果在使用上有疑問，請在採購前與我們聯繫，以便提供技術上的協助。

CAT.2023/V2

FZ Series

□ DIMENSIONS & MAXIMUM PERMISSIBLE RIPPLE CURRENT & IMPEDANCE 規格尺寸及最大允許紋波電流及阻抗值

WV		63			80			100		
μF		1J			1K			2A		
3.3	3R3				5 × 5.8	5.0	25			
4.7	4R7	5 × 5.8	3.0	50	6.3 × 5.8	3.0	40			
10	100	6.3 × 7.7 (6.3 × 5.8)	1.2 (1.5)	120 (80)	6.3 × 7.7	2.4	60	8 × 10.5	1.3	130
22	220	8 × 10.5 (6.3 × 7.7)	0.65 (1.2)	250 (120)	8 × 10.5	1.3	130	10 × 10.5 (8 × 10.5)	0.7 (1.3)	200 (160)
33	330	8 × 10.5	0.65	250	10 × 10.5	0.7	200	10 × 13.5	0.7	200
47	470	10 × 10.5 (8 × 10.5)	0.5 (0.65)	300 (250)	10 × 13.5	0.45	300	12.5 × 13.5	0.32	500
68	680	12.5 × 13.5 (10 × 10.5)	0.16 (0.5)	800 (300)	12.5 × 13.5	0.32	500	12.5 × 13.5	0.32	500
100	101	12.5 × 13.5 (10 × 13.5) (10 × 10.5)	0.16 (0.25) (0.5)	800 (400) (300)	12.5 × 13.5 (10 × 13.5)	0.32 (0.18)	500 (750)	16 × 16.5 (12.5 × 16) (12.5 × 13.5)	0.17 (0.26) (0.32)	795 (550) (500)
150	151	12.5 × 13.5 (10 × 13.5)	0.16 (0.25)	800 (650)	12.5 × 13.5	0.32	500	16 × 16.5 (12.5 × 16)	0.17 (0.26)	650 (550)
220	221	12.5 × 13.5	0.16	800	12.5 × 16 (12.5 × 13.5)	0.26 (0.12)	550 (900)	18 × 16.5	0.15	850
330	331	16 × 16.5	0.082	900	16 × 16.5	0.17	795	18 × 16.5	0.15	850
470	471	16 × 16.5	0.082	900	18 × 16.5	0.15	850	18 × 18.5	0.15	950
680	681	18 × 16.5	0.08	1150	18 × 18.5	0.15	950	Case size 尺寸	Impedance 阻抗值	Ripple current 紋波電流
1000	102	18 × 18.5	0.06	1250						

•Case size 尺寸 $\varnothing D \times L$ (mm), Impedance 阻抗值 (Ω) at 20°C, 100KHz, Ripple current 紋波電流 (mA rms) at 105°C, 100KHz

□ FREQUENCY COEFFICIENT OF ALLOWABLE RIPPLE CURRENT 紋波電流頻率補償系數

Frequency 頻率		50Hz	120Hz	300Hz	1KHz	10KHz~	
Coefficient 系數	$\varnothing 4 \sim \varnothing 10$	4.7 ~ 68 μ F	0.35	0.50	0.64	0.83	1.00
		100 ~ 1500 μ F	0.40	0.55	0.70	0.85	1.00
	$\varnothing 12.5 \sim \varnothing 18$	~ 68 μ F	0.40	0.55	0.70	0.85	1.00
		100 ~ 680 μ F	0.45	0.65	0.80	0.90	1.00
		1000 ~ 4700 μ F	0.65	0.85	0.95	1.00	1.00

The endurance of capacitors is reduced with internal heating produced by ripple current at the rate of halving the lifetime with every 5~10°C rise. When long life performance is required in actual use, the rms ripple current has to be reduced. 鋁電解電容器在疊加紋波電流後會引起發熱，溫度每上升 5~10°C 壽命會減半。若要保持長壽命性能，請在使用過程中適當降低紋波電流。

- Taping specifications are given in page 17. 編帶標準請查閱第 17 頁。
- Soldering conditions and recommended land size are given in page 23. 焊接條件及推薦安裝尺寸請查閱第 23 頁。
- Please refer to page 18 for the minimum package quantity. 最小包裝數量請查閱第 18 頁。
- Please refer to page 15 for the Part Number System. 產品編碼規則請查閱第 15 頁。

Note: All design and specifications are for reference only and is subject to change without prior notice. If any doubt about safety for your application, please contact us immediately for technical assistance before purchase.

注：以上所提供的設計及特性參數僅供參考，任何修改不作預先通知。如果在使用上有疑問，請在採購前與我們聯繫，以便提供技術上的協助。

CAT.2023/V2

FS Series New
新品

CHIP TYPE, LONG LIFE WITH EXTRA LOWER IMPEDANCE

貼片式，長壽命極低阻抗品



- Extra lower impedance
極低阻抗
- Endurance 2000~5000 hours
耐久性 2000~5000 小時
- Miniature (size small than FZ series)
縮體型 (尺寸比 FZ 系列小)
- RoHS & REACH compliant, Halogen-free
符合 RoHS 與 REACH, 無鹵

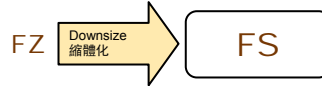

□ SPECIFICATIONS 特性表

Items 項目	Characteristics 主要特性														
Category Temperature Range 工作溫度範圍	-55 ~ +105°C														
Voltage Range 額定工作電壓範圍	6.3 ~ 50V														
Capacitance Range 靜電容量範圍	10 ~ 2200µF														
Capacitance Tolerance 靜電容量允許偏差	±20% at 120Hz, 20°C														
Leakage Current 漏電流	Leakage current ≤0.01CV or 3µA, whichever is greater (after 2 minutes application of rated voltage at 20°C) 漏電流 ≤0.01CV 或 3µA, 取較大值 (在 20°C 環境中施加額定工作電壓 2 分鐘後) C: Nominal capacitance (µF) 標稱靜電容量, V: Rated voltage (V) 額定電壓														
Dissipation Factor (tan δ) 損耗角正切	Measurement frequency 測試頻率: 120Hz, Temperature 溫度: 20°C <table border="1"> <tr> <td>Rated Voltage (V) 額定工作電壓</td> <td>6.3</td> <td>10</td> <td>16</td> <td>25</td> <td>35</td> <td>50</td> </tr> <tr> <td>tan δ (max.) 最大損耗角正切</td> <td>0.26</td> <td>0.19</td> <td>0.16</td> <td>0.14</td> <td>0.12</td> <td>0.10</td> </tr> </table>	Rated Voltage (V) 額定工作電壓	6.3	10	16	25	35	50	tan δ (max.) 最大損耗角正切	0.26	0.19	0.16	0.14	0.12	0.10
Rated Voltage (V) 額定工作電壓	6.3	10	16	25	35	50									
tan δ (max.) 最大損耗角正切	0.26	0.19	0.16	0.14	0.12	0.10									
Stability at Low Temperature 低溫特性	Measurement frequency 測試頻率: 120Hz <table border="1"> <tr> <td colspan="2">Rated Voltage (V) 額定工作電壓</td> <td>6.3 ~ 16</td> <td>25 ~ 50</td> </tr> <tr> <td rowspan="3">Impedance Ratio 阻抗比</td> <td>Z(-25°C) / Z(20°C)</td> <td>2</td> <td>2</td> </tr> <tr> <td>Z(-40°C) / Z(20°C)</td> <td>3</td> <td>3</td> </tr> <tr> <td>ZT/Z20 (max.)</td> <td>4</td> <td>3</td> </tr> </table>	Rated Voltage (V) 額定工作電壓		6.3 ~ 16	25 ~ 50	Impedance Ratio 阻抗比	Z(-25°C) / Z(20°C)	2	2	Z(-40°C) / Z(20°C)	3	3	ZT/Z20 (max.)	4	3
Rated Voltage (V) 額定工作電壓		6.3 ~ 16	25 ~ 50												
Impedance Ratio 阻抗比	Z(-25°C) / Z(20°C)	2	2												
	Z(-40°C) / Z(20°C)	3	3												
	ZT/Z20 (max.)	4	3												
Endurance 耐久性	After 5000 hrs. (2000 hrs. for Ø4~Ø6.3×5.8) application of the rated voltage at 105°C, they meet the characteristics listed below. 在 105°C 環境中施加額定工作電壓 5000 小時 (Ø4~Ø6.3×5.8 為 2000 小時) 後, 電容器的特性符合下表的要求。 <table border="1"> <tr> <td>Capacitance Change 靜電容量變化率</td> <td>Within ±35% of initial value 初始值的±35%以內</td> </tr> <tr> <td>Dissipation Factor 損耗角正切</td> <td>300% or less of initial specified value 不大於規範值的 300%</td> </tr> <tr> <td>Leakage Current 漏電流</td> <td>initial specified value or less 不大於規範值</td> </tr> </table>	Capacitance Change 靜電容量變化率	Within ±35% of initial value 初始值的±35%以內	Dissipation Factor 損耗角正切	300% or less of initial specified value 不大於規範值的 300%	Leakage Current 漏電流	initial specified value or less 不大於規範值								
Capacitance Change 靜電容量變化率	Within ±35% of initial value 初始值的±35%以內														
Dissipation Factor 損耗角正切	300% or less of initial specified value 不大於規範值的 300%														
Leakage Current 漏電流	initial specified value or less 不大於規範值														
Shelf Life 高溫貯存特性	After leaving capacitors under no load at 105°C for 1000 hours, they meet the specified value for load life characteristics listed above. 在 105°C 環境中無負荷放置 1000 小時後, 電容器的特性符合高溫負荷特性中所列的規定值。														
Resistance to Soldering Heat 耐焊接熱特性 (Please refer page 23 for soldering conditions) (焊接條件請查閱第 23 頁)	After reflow soldering and restored at room temperature, they meet the characteristics listed below. 經過回流焊並冷卻至室溫後, 電容器的特性符合下表的要求。 <table border="1"> <tr> <td>Capacitance Change 靜電容量變化率</td> <td>Within ±10% of initial value 初始值的±10%以內</td> </tr> <tr> <td>Dissipation Factor 損耗角正切</td> <td>initial specified value or less 不大於規範值</td> </tr> <tr> <td>Leakage Current 漏電流</td> <td>initial specified value or less 不大於規範值</td> </tr> </table>	Capacitance Change 靜電容量變化率	Within ±10% of initial value 初始值的±10%以內	Dissipation Factor 損耗角正切	initial specified value or less 不大於規範值	Leakage Current 漏電流	initial specified value or less 不大於規範值								
Capacitance Change 靜電容量變化率	Within ±10% of initial value 初始值的±10%以內														
Dissipation Factor 損耗角正切	initial specified value or less 不大於規範值														
Leakage Current 漏電流	initial specified value or less 不大於規範值														
Marking 標識	Black print on the case top. 鋁殼頂部黑字印刷。														

□ DRAWING 外形圖 (Unit: mm)

(Ø4~Ø6.3×7.7)

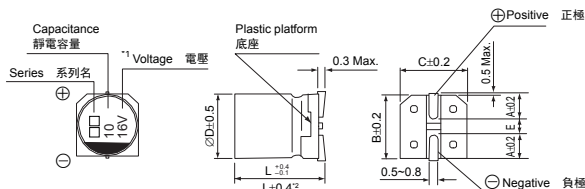

(Ø8×10.5~Ø10)

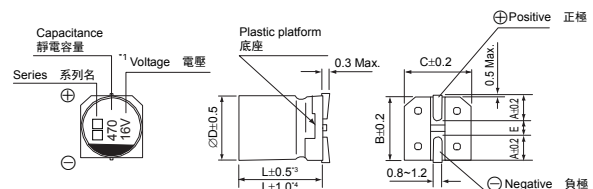

*1. Voltage mark for 6.3V is [6V]
*2. Applicable to Ø6.3×7.7
*3. Applicable to Ø8×10.5~Ø10

6.3V 的產品標識為 [6V]
適用於 Ø6.3×7.7
適用於 Ø8×10.5~Ø10

Dimension table in next page.
尺寸表見下一頁。

Note: All design and specifications are for reference only and is subject to change without prior notice. If any doubt about safety for your application, please contact us immediately for technical assistance before purchase.

注: 以上所提供的設計及特性參數僅供參考, 任何修改不作預先通知。如果在使用上有疑問, 請在採購前與我們聯繫, 以便提供技術上的協助。

CAT.2023/V2

FS Series New
新品

□ DIMENSIONS (Unit: mm) 尺寸表

∅D x L	4 x 5.8	5 x 5.8	6.3 x 5.8/7.7	8 x 10.5	10 x 10.5
A	2.0	2.2	2.6	3.0	3.3
B	4.3	5.3	6.6	8.4	10.4
C	4.3	5.3	6.6	8.4	10.4
E ± 0.2	1.0	1.4	1.9	3.1	4.7
L	5.8	5.8	5.8/7.7	10.5	10.5

□ DIMENSIONS & MAXIMUM PERMISSIBLE RIPPLE CURRENT & IMPEDANCE 規格尺寸及最大允許紋波電流及阻抗值

WV Code 代碼	6.3			10			16		
	0J			1A			1C		
47 470							4 x 5.8	0.85	160
68 680				4 x 5.8	0.85	160	5 x 5.8	0.36	240
100 101	4 x 5.8	0.85	160				5 x 5.8	0.36	240
150 151				5 x 5.8	0.36	240	6.3 x 5.8	0.26	300
220 221	5 x 5.8	0.36	240	6.3 x 5.8	0.26	300	6.3 x 5.8	0.26	300
330 331	6.3 x 5.8	0.26	300	6.3 x 7.7	0.16	600	6.3 x 7.7	0.16	600
470 471	6.3 x 7.7	0.16	600	6.3 x 7.7	0.16	600			
680 681	6.3 x 7.7	0.16	600				8 x 10.5	0.08	850
820 821							8 x 10.5	0.08	850
1000 102				8 x 10.5	0.08	850	10 x 10.5	0.06	1190
1200 122							10 x 10.5	0.06	1190
1500 152	8 x 10.5	0.08	850	10 x 10.5	0.06	1190	Case size 尺寸	Impedance 阻抗值	Ripple current 紋波電流
2200 222	10 x 10.5	0.06	1190						

WV Code 代碼	25			35			50		
	1E			1V			1H		
10 100							5 x 5.8 (4 x 5.8)	0.88 (2.30)	165 (85)
22 220	4 x 5.8	0.85	160	4 x 5.8	0.85	160	5 x 5.8	0.88	165
33 330	4 x 5.8	0.85	160	5 x 5.8	0.36	240			
47 470	5 x 5.8	0.36	240	5 x 5.8	0.36	240	6.3 x 5.8	0.68	195
68 680	5 x 5.8	0.36	240	6.3 x 5.8	0.26	300			
100 101	6.3 x 5.8	0.26	300	6.3 x 5.8	0.26	300	6.3 x 7.7	0.34	350
150 151	6.3 x 7.7	0.16	600	6.3 x 7.7	0.16	600			
220 221	6.3 x 7.7	0.16	600				8 x 10.5	0.18	670
330 331	6.3 x 7.7	0.16	600	8 x 10.5	0.08	850	10 x 10.5	0.12	900
390 391				8 x 10.5	0.08	850			
470 471	8 x 10.5	0.08	850						
560 561	8 x 10.5	0.08	850	10 x 10.5	0.06	1190			
680 681				10 x 10.5	0.06	1190			
820 821	10 x 10.5	0.06	1190				Case size 尺寸	Impedance 阻抗值	Ripple current 紋波電流
1000 102	10 x 10.5	0.06	1190						

*Case size 尺寸 ∅D×L(mm), Impedance 阻抗值 (Ω) at 20°C, 100KHz, Ripple current 紋波電流 (mA rms) at 105°C, 100KHz

□ FREQUENCY COEFFICIENT OF ALLOWABLE RIPPLE CURRENT 紋波電流頻率補償係數

Frequency 頻率	Frequency 頻率					
	50Hz	120Hz	300Hz	1KHz	10KHz~	
Coefficient 係數	10 ~ 68μF	0.35	0.50	0.64	0.83	1.00
	100 ~ 2200μF	0.40	0.55	0.70	0.85	1.00

The endurance of capacitors is reduced with internal heating produced by ripple current at the rate of halving the lifetime with every 5~10°C rise. When long life performance is required in actual use, the rms ripple current has to be reduced. 鋁電解電容器在疊加紋波電流後會引起發熱，溫度每上升 5~10°C 壽命會減半。若要保持長壽命性能，請在使用過程中適當降低紋波電流。

- Taping specifications are given in page 17. 編帶標準請查閱第 17 頁。
- Soldering conditions and recommended land size are given in page 23. 焊接條件及推薦安裝尺寸請查閱第 23 頁。
- Please refer to page 18 for the minimum package quantity. 最小包裝數量請查閱第 18 頁。
- Please refer to page 15 for the Part Number System. 產品編碼規則請查閱第 15 頁。

Note: All design and specifications are for reference only and is subject to change without prior notice. If any doubt about safety for your application, please contact us immediately for technical assistance before purchase.

注：以上所提供的設計及特性參數僅供參考，任何修改不作預先通知。如果在使用上有疑問，請在採購前與我們聯繫，以便提供技術上的協助。

CAT.2023/V2

EL Series

CHIP TYPE, LONG LIFE ASSURANCE

貼片式，寬溫長壽命品

- Wide temperature range -55~+105°C
適用於 -55~+105°C 的寬溫範圍
- Endurance 2000~3000 hours
耐久性 2000~3000 小時
- RoHS & REACH compliant, Halogen-free
符合 RoHS 與 REACH，無鹵

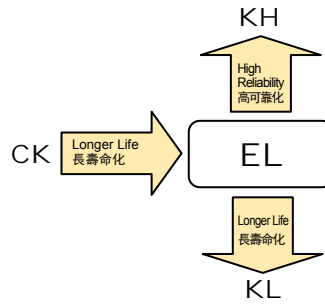

□ SPECIFICATIONS 特性表

Items 項目	Characteristics 主要特性																																						
Category 工作溫度範圍	-55 ~ +105°C																																						
Voltage Range 額定工作電壓範圍	6.3 ~ 50V																																						
Capacitance Range 靜電容量範圍	0.1 ~ 1500µF																																						
Capacitance Tolerance 靜電容量允許偏差	±20% at 120Hz, 20°C																																						
Leakage Current 漏電流	Leakage current ≤0.01CV or 3µA (∅4~∅10), whichever is greater (after 2 minutes application of rated voltage at 20°C) Leakage current ≤0.03CV or 4µA (∅12.5~∅16), whichever is greater (after 1 minute application of rated voltage at 20°C) 漏電流≤0.01CV 或 3µA (∅4~∅10)，取較大值（在 20°C 環境中施加額定工作電壓 2 分鐘後） 漏電流≤0.03CV 或 4µA (∅12.5~∅16)，取較大值（在 20°C 環境中施加額定工作電壓 1 分鐘後） C: Nominal capacitance (µF) 標稱靜電容量, V: Rated voltage (V) 額定電壓																																						
Dissipation Factor (tan δ) 損耗角正切	Measurement frequency 測試頻率: 120Hz, Temperature 溫度: 20°C <table border="1"> <thead> <tr> <th>Rated Voltage (V) 額定工作電壓</th> <th>6.3</th> <th>10</th> <th>16</th> <th>25</th> <th>35</th> <th>50</th> </tr> </thead> <tbody> <tr> <td>tan δ (max.) ∅4~∅10</td> <td>0.28</td> <td>0.24</td> <td>0.20</td> <td>0.16</td> <td>0.13</td> <td>0.12</td> </tr> <tr> <td>最大損耗角正切 ∅12.5~∅16</td> <td>0.38</td> <td>0.34</td> <td>0.30</td> <td>0.26</td> <td>0.22</td> <td>0.18</td> </tr> </tbody> </table>	Rated Voltage (V) 額定工作電壓	6.3	10	16	25	35	50	tan δ (max.) ∅4~∅10	0.28	0.24	0.20	0.16	0.13	0.12	最大損耗角正切 ∅12.5~∅16	0.38	0.34	0.30	0.26	0.22	0.18																	
Rated Voltage (V) 額定工作電壓	6.3	10	16	25	35	50																																	
tan δ (max.) ∅4~∅10	0.28	0.24	0.20	0.16	0.13	0.12																																	
最大損耗角正切 ∅12.5~∅16	0.38	0.34	0.30	0.26	0.22	0.18																																	
Stability at Low Temperature 低溫特性	Measurement frequency 測試頻率: 120Hz <table border="1"> <thead> <tr> <th colspan="2">Rated Voltage (V) 額定工作電壓</th> <th>6.3</th> <th>10</th> <th>16</th> <th>25</th> <th>35</th> <th>50</th> </tr> </thead> <tbody> <tr> <td rowspan="2">Impedance Ratio 阻抗比 ZT/Z20 (max.) ∅4~∅10</td> <td>Z(-25°C) / Z(20°C)</td> <td>3</td> <td>3</td> <td>2</td> <td>2</td> <td>2</td> <td>2</td> </tr> <tr> <td>Z(-55°C) / Z(20°C)</td> <td>8</td> <td>5</td> <td>4</td> <td>3</td> <td>3</td> <td>3</td> </tr> <tr> <td rowspan="2">∅12.5~∅16</td> <td>Z(-25°C) / Z(20°C)</td> <td>5</td> <td>4</td> <td>3</td> <td>2</td> <td>2</td> <td>2</td> </tr> <tr> <td>Z(-55°C) / Z(20°C)</td> <td>12</td> <td>10</td> <td>8</td> <td>5</td> <td>4</td> <td>3</td> </tr> </tbody> </table>	Rated Voltage (V) 額定工作電壓		6.3	10	16	25	35	50	Impedance Ratio 阻抗比 ZT/Z20 (max.) ∅4~∅10	Z(-25°C) / Z(20°C)	3	3	2	2	2	2	Z(-55°C) / Z(20°C)	8	5	4	3	3	3	∅12.5~∅16	Z(-25°C) / Z(20°C)	5	4	3	2	2	2	Z(-55°C) / Z(20°C)	12	10	8	5	4	3
Rated Voltage (V) 額定工作電壓		6.3	10	16	25	35	50																																
Impedance Ratio 阻抗比 ZT/Z20 (max.) ∅4~∅10	Z(-25°C) / Z(20°C)	3	3	2	2	2	2																																
	Z(-55°C) / Z(20°C)	8	5	4	3	3	3																																
∅12.5~∅16	Z(-25°C) / Z(20°C)	5	4	3	2	2	2																																
	Z(-55°C) / Z(20°C)	12	10	8	5	4	3																																
Endurance 耐久性	After 3000 hrs. (2000 hrs. for ∅4~∅6.3×5.8) application of the rated voltage at 105°C, they meet the characteristics listed below. 在 105°C 環境中施加額定工作電壓 3000 小時 (∅4~∅6.3×5.8 為 2000 小時) 後，電容器的特性符合下表的要求。 <table border="1"> <tr> <td>Capacitance Change 靜電容量變化率</td> <td>Within ±25% of initial value 初始值的±25%以內</td> </tr> <tr> <td>Dissipation Factor 損耗角正切</td> <td>200% or less of initial specified value 不大於規範值的 200%</td> </tr> <tr> <td>Leakage Current 漏電流</td> <td>initial specified value or less 不大於規範值</td> </tr> </table>	Capacitance Change 靜電容量變化率	Within ±25% of initial value 初始值的±25%以內	Dissipation Factor 損耗角正切	200% or less of initial specified value 不大於規範值的 200%	Leakage Current 漏電流	initial specified value or less 不大於規範值																																
Capacitance Change 靜電容量變化率	Within ±25% of initial value 初始值的±25%以內																																						
Dissipation Factor 損耗角正切	200% or less of initial specified value 不大於規範值的 200%																																						
Leakage Current 漏電流	initial specified value or less 不大於規範值																																						
Shelf Life 高溫貯存特性	After leaving capacitors under no load at 105°C for 1000 hours, they meet the specified value for load life characteristics listed above. 在 105°C 環境中無負荷放置 1000 小時後，電容器的特性符合高溫負荷特性中所列的規定值。																																						
Resistance to Soldering Heat 耐焊接熱特性 (Please refer page 23 for soldering conditions) (焊接條件請查閱第 23 頁)	After reflow soldering and restored at room temperature, they meet the characteristics listed below. 經過回流焊並冷卻至室溫後，電容器的特性符合下表的要求。 <table border="1"> <tr> <td>Capacitance Change 靜電容量變化率</td> <td>Within ±10% of initial value 初始值的±10%以內</td> </tr> <tr> <td>Dissipation Factor 損耗角正切</td> <td>initial specified value or less 不大於規範值</td> </tr> <tr> <td>Leakage Current 漏電流</td> <td>initial specified value or less 不大於規範值</td> </tr> </table>	Capacitance Change 靜電容量變化率	Within ±10% of initial value 初始值的±10%以內	Dissipation Factor 損耗角正切	initial specified value or less 不大於規範值	Leakage Current 漏電流	initial specified value or less 不大於規範值																																
Capacitance Change 靜電容量變化率	Within ±10% of initial value 初始值的±10%以內																																						
Dissipation Factor 損耗角正切	initial specified value or less 不大於規範值																																						
Leakage Current 漏電流	initial specified value or less 不大於規範值																																						
Marking 標識	Black print on the case top. 鋁殼頂部黑字印刷。																																						

□ DRAWING 外形圖 (Unit: mm)

(∅4~∅6.3×7.7)

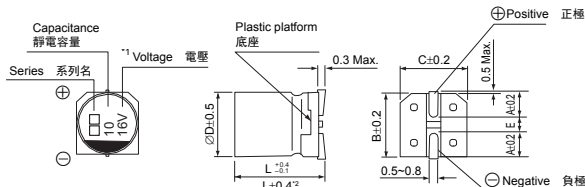

(∅8×10.5~∅16)

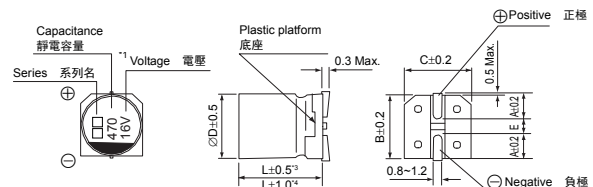

*1. Voltage mark for 6.3V is [6V]
*2. Applicable to ∅6.3×7.7
*3. Applicable to ∅8×10.5~∅10
*4. Applicable to ∅12.5~∅16

6.3V 的產品標識為 [6V]
適用於 ∅6.3×7.7
適用於 ∅8×10.5~∅10
適用於 ∅12.5~∅16

Dimension table in next page.
尺寸表見下一頁。

Note: All design and specifications are for reference only and is subject to change without prior notice. If any doubt about safety for your application, please contact us immediately for technical assistance before purchase.

注: 以上所提供的設計及特性參數僅供參考，任何修改不作預先通知。如果在使用上有疑問，請在採購前與我們聯繫，以便提供技術上的協助。

CAT.2023/V2

EL Series

□ DIMENSIONS (Unit: mm) 尺寸表

∅D x L	4 x 5.8	5 x 5.8	6.3 x 5.8	6.3 x 7.7	8 x 10.5	10 x 10.5	10 x 13.5	12.5 x 13.5	12.5 x 16	16 x 16.5
A	2.0	2.2	2.6	2.6	3.0	3.3	3.3	4.9	4.9	5.8
B	4.3	5.3	6.6	6.6	8.4	10.4	10.4	13.0	13.0	17.0
C	4.3	5.3	6.6	6.6	8.4	10.4	10.4	13.0	13.0	17.0
E ± 0.2	1.0	1.4	1.9	1.9	3.1	4.7	4.7	4.7	4.7	6.4
L	5.8	5.8	5.8	7.7	10.5	10.5	13.5	13.5	16.0	16.5

□ DIMENSIONS & MAXIMUM PERMISSIBLE RIPPLE CURRENT 規格尺寸及最大允許紋波電流

WV Code 代碼	μF	6.3		10		16		25		35		50	
		0J		1A		1C		1E		1V		1H	
0.1	0R1											4 x 5.8	1
0.22	R22											4 x 5.8	2
0.33	R33											4 x 5.8	3
0.47	R47											4 x 5.8	5
1	010											4 x 5.8	10
2.2	2R2											4 x 5.8	16
3.3	3R3											4 x 5.8	16
4.7	4R7							4 x 5.8	13	4 x 5.8	14	5 x 5.8	23
10	100					4 x 5.8	18	5 x 5.8	20	5 x 5.8	21	6.3 x 5.8	35
22	220	4 x 5.8	22	5 x 5.8	25	5 x 5.8	27	6.3 x 5.8	36	6.3 x 5.8	38	6.3 x 7.7	70
33	330	5 x 5.8	27	5 x 5.8	30	6.3 x 5.8	40	6.3 x 5.8	60	6.3 x 7.7	84	8 x 10.5	90
47	470	5 x 5.8	33	6.3 x 5.8	41	6.3 x 5.8	48	6.3 x 7.7	90	8 x 10.5	98	8 x 10.5	90
100	101	6.3 x 5.8	50	6.3 x 5.8	53	6.3 x 5.8	60	8 x 10.5	130	8 x 10.5	130	10 x 10.5	100
150	151	6.3 x 5.8	55	6.3 x 7.7	105	6.3 x 7.7	95	8 x 10.5	140	10 x 10.5	315	10 x 10.5	100
220	221	6.3 x 7.7	100	8 x 10.5	210	8 x 10.5	210	10 x 10.5	190	10 x 10.5	315	10 x 13.5 (10 x 10.5)	250 (100)
330	331	8 x 10.5	210	8 x 10.5	210	8 x 10.5	210	10 x 10.5	315	10 x 10.5	315	12.5 x 13.5	400
470	471	8 x 10.5	210	10 x 10.5	315	10 x 10.5	315	10 x 10.5	315	12.5 x 13.5 (10 x 13.5)	500 (360)	16 x 16.5 (12.5 x 16)	650 (500)
680	681	8 x 10.5	210	10 x 10.5	315	10 x 10.5	315	10 x 13.5	380	12.5 x 13.5	500		
1000	102	10 x 10.5	315	10 x 13.5 (10 x 10.5)	360 (315)	12.5 x 13.5 (10 x 13.5) (10 x 10.5)	450 (350) (315)	12.5 x 13.5	550	16 x 16.5 (12.5 x 16)	700 (550)		
1500	152	10 x 13.5 (10 x 10.5)	450 (315)	12.5 x 13.5	500	12.5 x 13.5	500	12.5 x 16	800				
2200	222	12.5 x 13.5	620	12.5 x 16 (12.5 x 13.5)	650 (600)	16 x 16.5	900	16 x 16.5	1000			Case size 尺寸	Ripple current 紋波電流
3300	332	12.5 x 16	750	16 x 16.5	950								

•Case size ∅D×L(mm), ripple current (mA rms) at 105°C, 120Hz •尺寸∅D×L(mm), 紋波電流(mA rms)於 105°C, 120Hz

□ FREQUENCY COEFFICIENT OF ALLOWABLE RIPPLE CURRENT 紋波電流頻率補償系數

Frequency 頻率		50Hz	120Hz	300Hz	1KHz	10KHz~
Coefficient 系數	∅4 ~ ∅10	0.1 ~ 100μF	0.70	1.00	1.17	1.36
		150 ~ 1500μF	0.85	1.00	1.08	1.20
	∅12.5 ~ ∅16	~ 470μF	0.75	1.00	1.35	1.57
		680 ~ 3300μF	0.85	1.00	1.23	1.34

The endurance of capacitors is reduced with internal heating produced by ripple current at the rate of halving the lifetime with every 5~10°C rise. When long life performance is required in actual use, the rms ripple current has to be reduced. 鋁電解電容器在疊加紋波電流後會引起發熱，溫度每上升 5~10°C 壽命會減半。若要保持長壽命性能，請在使用過程中適當降低紋波電流。

- Taping specifications are given in page 17. 編帶標準請查閱第 17 頁。
- Soldering conditions and recommended land size are given in page 23. 焊接條件及推薦安裝尺寸請查閱第 23 頁。
- Please refer to page 18 for the minimum package quantity. 最小包裝數量請查閱第 18 頁。
- Please refer to page 15 for the Part Number System. 產品編碼規則請查閱第 15 頁。

Note: All design and specifications are for reference only and is subject to change without prior notice. If any doubt about safety for your application, please contact us immediately for technical assistance before purchase.

注：以上所提供的設計及特性參數僅供參考，任何修改不作預先通知。如果在使用上有疑問，請在採購前與我們聯繫，以便提供技術上的協助。

CAT.2023/V2

KL Series

CHIP TYPE, 5000 HOURS LONG LIFE ASSURANCE

貼片式, 5000 小時長壽命品

- Wide temperature range -55~+105°C
適用於 -55~+105°C 的寬溫範圍
- Endurance 3000~5000 hours
耐久性 3000~5000 小時
- RoHS & REACH compliant, Halogen-free
符合 RoHS 與 REACH, 無鹵

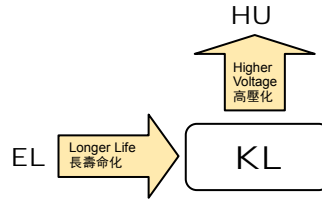

SPECIFICATIONS 特性表

Items 項目	Characteristics 主要特性																																	
Category Temperature Range 工作溫度範圍	-55 ~ +105°C																																	
Voltage Range 額定工作電壓範圍	6.3 ~ 100V																																	
Capacitance Range 靜電容量範圍	0.1 ~ 1500µF																																	
Capacitance Tolerance 靜電容量允許偏差	±20% at 120Hz, 20°C																																	
Leakage Current 漏電流	Leakage current ≤0.01CV or 3µA (Ø4~Ø10), whichever is greater (after 2 minutes application of rated voltage at 20°C) Leakage current ≤0.03CV or 4µA (Ø12.5~Ø16), whichever is greater (after 1 minute application of rated voltage at 20°C) 漏電流 ≤0.01CV 或 3µA (Ø4~Ø10), 取較大值 (在 20°C 環境中施加額定工作電壓 2 分鐘後) 漏電流 ≤0.03CV 或 4µA (Ø12.5~Ø16), 取較大值 (在 20°C 環境中施加額定工作電壓 1 分鐘後)																																	
Dissipation Factor (tan δ) 損耗角正切	C: Nominal capacitance (µF) 標稱靜電容量, V: Rated voltage (V) 額定電壓 Measurement frequency 測試頻率: 120Hz, Temperature 溫度: 20°C <table border="1"> <thead> <tr> <th>Rated Voltage (V) 額定工作電壓</th> <th>6.3</th> <th>10</th> <th>16</th> <th>25</th> <th>35</th> <th>50~100</th> </tr> </thead> <tbody> <tr> <td>tan δ (max.) Ø4~Ø10</td> <td>0.28</td> <td>0.24</td> <td>0.20</td> <td>0.16</td> <td>0.13</td> <td>0.12</td> </tr> <tr> <td>最大損耗角正切 Ø12.5~Ø16</td> <td>0.38</td> <td>0.34</td> <td>0.30</td> <td>0.26</td> <td>0.22</td> <td>0.18</td> </tr> </tbody> </table>	Rated Voltage (V) 額定工作電壓	6.3	10	16	25	35	50~100	tan δ (max.) Ø4~Ø10	0.28	0.24	0.20	0.16	0.13	0.12	最大損耗角正切 Ø12.5~Ø16	0.38	0.34	0.30	0.26	0.22	0.18												
Rated Voltage (V) 額定工作電壓	6.3	10	16	25	35	50~100																												
tan δ (max.) Ø4~Ø10	0.28	0.24	0.20	0.16	0.13	0.12																												
最大損耗角正切 Ø12.5~Ø16	0.38	0.34	0.30	0.26	0.22	0.18																												
Stability at Low Temperature 低溫特性	Measurement frequency 測試頻率: 120Hz <table border="1"> <thead> <tr> <th>Rated Voltage (V) 額定工作電壓</th> <th>6.3</th> <th>10</th> <th>16</th> <th>25</th> <th>35</th> <th>50~100</th> </tr> </thead> <tbody> <tr> <td rowspan="2">Impedance Ratio 阻抗比</td> <td>Z(-25°C) / Z(20°C)</td> <td>3</td> <td>3</td> <td>2</td> <td>2</td> <td>2</td> </tr> <tr> <td>Z(-55°C) / Z(20°C)</td> <td>8</td> <td>5</td> <td>4</td> <td>3</td> <td>3</td> </tr> <tr> <td rowspan="2">ZT/Z20 (max.) Ø12.5~Ø16</td> <td>Z(-25°C) / Z(20°C)</td> <td>5</td> <td>4</td> <td>3</td> <td>2</td> <td>2</td> </tr> <tr> <td>Z(-55°C) / Z(20°C)</td> <td>12</td> <td>10</td> <td>8</td> <td>5</td> <td>4</td> </tr> </tbody> </table>	Rated Voltage (V) 額定工作電壓	6.3	10	16	25	35	50~100	Impedance Ratio 阻抗比	Z(-25°C) / Z(20°C)	3	3	2	2	2	Z(-55°C) / Z(20°C)	8	5	4	3	3	ZT/Z20 (max.) Ø12.5~Ø16	Z(-25°C) / Z(20°C)	5	4	3	2	2	Z(-55°C) / Z(20°C)	12	10	8	5	4
Rated Voltage (V) 額定工作電壓	6.3	10	16	25	35	50~100																												
Impedance Ratio 阻抗比	Z(-25°C) / Z(20°C)	3	3	2	2	2																												
	Z(-55°C) / Z(20°C)	8	5	4	3	3																												
ZT/Z20 (max.) Ø12.5~Ø16	Z(-25°C) / Z(20°C)	5	4	3	2	2																												
	Z(-55°C) / Z(20°C)	12	10	8	5	4																												
Endurance 耐久性	After 5000 hrs. (3000 hrs. for Ø4~Ø6.3x5.8) application of the rated voltage at 105°C, they meet the characteristics listed below. 在 105°C 環境中施加額定工作電壓 5000 小時 (Ø4~Ø6.3x5.8 為 3000 小時) 後, 電容器的特性符合下表的要求。 <table border="1"> <tbody> <tr> <td>Capacitance Change 靜電容量變化率</td> <td>Within ±30% of initial value 初始值的±30%以內</td> </tr> <tr> <td>Dissipation Factor 損耗角正切</td> <td>300% or less of initial specified value 不大於規範值的 300%</td> </tr> <tr> <td>Leakage Current 漏電流</td> <td>initial specified value or less 不大於規範值</td> </tr> </tbody> </table>	Capacitance Change 靜電容量變化率	Within ±30% of initial value 初始值的±30%以內	Dissipation Factor 損耗角正切	300% or less of initial specified value 不大於規範值的 300%	Leakage Current 漏電流	initial specified value or less 不大於規範值																											
Capacitance Change 靜電容量變化率	Within ±30% of initial value 初始值的±30%以內																																	
Dissipation Factor 損耗角正切	300% or less of initial specified value 不大於規範值的 300%																																	
Leakage Current 漏電流	initial specified value or less 不大於規範值																																	
Shelf Life 高溫貯存特性	After leaving capacitors under no load at 105°C for 1000 hours, they meet the specified value for load life characteristics listed above. 在 105°C 環境中無負荷放置 1000 小時後, 電容器的特性符合高溫負荷特性中所列的規定值。																																	
Resistance to Soldering Heat 耐焊接熱特性 (Please refer page 23 for soldering conditions) (焊接條件請查閱第 23 頁)	After reflow soldering and restored at room temperature, they meet the characteristics listed below. 經過回流焊並冷卻至室溫後, 電容器的特性符合下表的要求。 <table border="1"> <tbody> <tr> <td>Capacitance Change 靜電容量變化率</td> <td>Within ±10% of initial value 初始值的±10%以內</td> </tr> <tr> <td>Dissipation Factor 損耗角正切</td> <td>initial specified value or less 不大於規範值</td> </tr> <tr> <td>Leakage Current 漏電流</td> <td>initial specified value or less 不大於規範值</td> </tr> </tbody> </table>	Capacitance Change 靜電容量變化率	Within ±10% of initial value 初始值的±10%以內	Dissipation Factor 損耗角正切	initial specified value or less 不大於規範值	Leakage Current 漏電流	initial specified value or less 不大於規範值																											
Capacitance Change 靜電容量變化率	Within ±10% of initial value 初始值的±10%以內																																	
Dissipation Factor 損耗角正切	initial specified value or less 不大於規範值																																	
Leakage Current 漏電流	initial specified value or less 不大於規範值																																	
Marking 標識	Black print on the case top. 鋁殼頂部黑字印刷。																																	

DRAWING 外形圖 (Unit: mm)

(Ø4~Ø6.3x7.7)

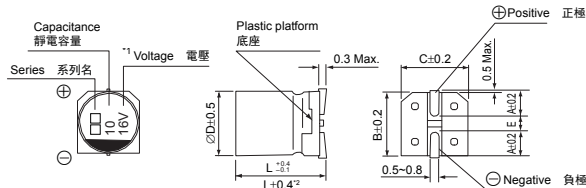

(Ø8~Ø10.5~Ø16)

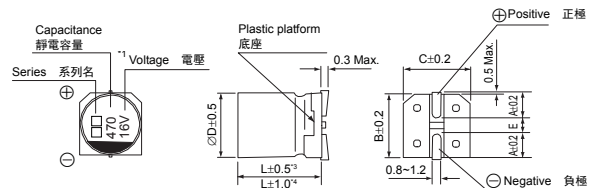

- *1. Voltage mark for 6.3V is [6V]
- *2. Applicable to Ø6.3x7.7
- *3. Applicable to Ø8x10.5~Ø10
- *4. Applicable to Ø12.5~Ø16

- 6.3V 的產品標識為 [6V]
- 適用於 Ø6.3x7.7
- 適用於 Ø8x10.5~Ø10
- 適用於 Ø12.5~Ø16

Dimension table in next page.
尺寸表見下一頁。

Note: All design and specifications are for reference only and is subject to change without prior notice. If any doubt about safety for your application, please contact us immediately for technical assistance before purchase.

注: 以上所提供的設計及特性參數僅供參考, 任何修改不作預先通知。如果在使用上有疑問, 請在採購前與我們聯繫, 以便提供技術上的協助。

CAT.2023/V2

KL Series

□ DIMENSIONS (Unit: mm) 尺寸表

∅D x L	4 x 5.8	5 x 5.8	6.3 x 5.8	6.3 x 7.7	8 x 10.5	10 x 10.5	10 x 13.5	12.5 x 13.5	12.5 x 16	16 x 16.5
A	2.0	2.2	2.6	2.6	3.0	3.3	3.3	4.9	4.9	5.8
B	4.3	5.3	6.6	6.6	8.4	10.4	10.4	13.0	13.0	17.0
C	4.3	5.3	6.6	6.6	8.4	10.4	10.4	13.0	13.0	17.0
E ± 0.2	1.0	1.4	1.9	1.9	3.1	4.7	4.7	4.7	4.7	6.4
L	5.8	5.8	5.8	7.7	10.5	10.5	13.5	13.5	16.0	16.5

□ DIMENSIONS & MAXIMUM PERMISSIBLE RIPPLE CURRENT 規格尺寸及最大允許紋波電流

μF	WV Code 代碼	6.3		10		16		25	
		0J		1A		1C		1E	
10	100					4 x 5.8	18	5 x 5.8	27
22	220	4 x 5.8	22	5 x 5.8	30	5 x 5.8	30	6.3 x 5.8	44
33	330	5 x 5.8	35	5 x 5.8	36	6.3 x 5.8	48	6.3 x 5.8	50
47	470	5 x 5.8	38	6.3 x 5.8	50	6.3 x 5.8	50	6.3 x 7.7	63
100	101	6.3 x 5.8	69	6.3 x 7.7	81	6.3 x 7.7	81	8 x 10.5	116
150	151	6.3 x 7.7	85	8 x 10.5	125	8 x 10.5	125	10 x 10.5	320
220	221	6.3 x 7.7	120	8 x 10.5	141	10 x 10.5	216	10 x 10.5	320
330	331	8 x 10.5	290	10 x 10.5	290	10 x 10.5	290	10 x 10.5	320
470	471	10 x 10.5	320	10 x 10.5	320	10 x 10.5	320	12.5 x 13.5 (10 x 13.5)	400 (350)
680	681	10 x 10.5	320	10 x 10.5	320	10 x 13.5	420	12.5 x 13.5	415
1000	102	10 x 10.5	410	10 x 13.5	390	12.5 x 13.5	550	12.5 x 13.5	460
1500	152	10 x 13.5	450	12.5 x 13.5	480	12.5 x 13.5	650	12.5 x 16	700
2200	222	12.5 x 13.5	680	12.5 x 16 (12.5 x 13.5)	750 (510)	16 x 16.5	800		
3300	332	12.5 x 16 (12.5 x 13.5)	850 (800)	16 x 16.5	800			Case size 尺寸	Ripple current 紋波電流

μF	WV Code 代碼	35		50		63		100	
		1V		1H		1J		2A	
0.1	0R1			4 x 5.8	1.0				
0.22	R22			4 x 5.8	2.6				
0.33	R33			4 x 5.8	3.2				
0.47	R47			4 x 5.8	5				
1	010			4 x 5.8	8				
2.2	2R2			4 x 5.8	12				
3.3	3R3			4 x 5.8	17			6.3 x 7.7	30
4.7	4R7	4 x 5.8	16	5 x 5.8	22			8 x 10.5	50
10	100	5 x 5.8	27	6.3 x 5.8	32	6.3 x 7.7	45	8 x 10.5	55
22	220	6.3 x 5.8	44	6.3 x 7.7	58	8 x 10.5	65	10 x 10.5	70
33	330	6.3 x 7.7	57	8 x 10.5	140	10 x 10.5	80	10 x 10.5	80
47	470	8 x 10.5	92	10 x 10.5	310	10 x 10.5	90	12.5 x 13.5 (10 x 13.5)	250 (150)
100	101	10 x 10.5	151	10 x 10.5	310	10 x 13.5	150	12.5 x 13.5	300
150	151	10 x 10.5	290	10 x 10.5	310			16 x 16.5 (12.5 x 16) (12.5 x 13.5)	600 (420) (380)
220	221	10 x 10.5	375	12.5 x 13.5 (10 x 13.5)	340 (320)	12.5 x 13.5	470		
330	331	12.5 x 13.5 (10 x 13.5)	380 (375)	12.5 x 16 (12.5 x 13.5)	600 (500)	16 x 16.5 (12.5 x 16)	650 (550)		
470	471	12.5 x 13.5	520	16 x 16.5	700	16 x 16.5	750		
680	681	12.5 x 13.5	550						
1000	102	16 x 16.5 (12.5 x 16)	750 (600)					Case size 尺寸	Ripple current 紋波電流

•Case size ∅D×L(mm), ripple current (mA rms) at 105°C, 120Hz •尺寸∅D×L(mm), 紋波電流(mA rms)於 105°C, 120Hz

Note: All design and specifications are for reference only and is subject to change without prior notice. If any doubt about safety for your application, please contact us immediately for technical assistance before purchase.

注：以上所提供的設計及特性參數僅供參考，任何修改不作預先通知。如果在使用上有疑問，請在採購前與我們聯繫，以便提供技術上的協助。

CAT.2023/V2

KL Series

□ FREQUENCY COEFFICIENT OF ALLOWABLE RIPPLE CURRENT 紋波電流頻率補償系數

Frequency 頻率		50Hz	120Hz	300Hz	1KHz	10KHz~	
Coefficient 系數	Ø4 ~ Ø10	0.70	1.00	1.17	1.36	1.50	
	Ø12.5 ~ Ø16	~ 68µF	0.75	1.00	1.35	1.57	2.00
		100 ~ 470µF	0.80	1.00	1.23	1.34	1.50
		680 ~ 3300µF	0.85	1.00	1.10	1.13	1.15

The endurance of capacitors is reduced with internal heating produced by ripple current at the rate of halving the lifetime with every 5~10°C rise. When long life performance is required in actual use, the rms ripple current has to be reduced. 鋁電解電容器在疊加紋波電流後會引起發熱，溫度每上升 5~10°C 壽命會減半。若要保持長壽命性能，請在使用過程中適當降低紋波電流。

- Taping specifications are given in page 17. 編帶標準請查閱第 17 頁。
- Soldering conditions and recommended land size are given in page 23. 焊接條件及推薦安裝尺寸請查閱第 23 頁。
- Please refer to page 18 for the minimum package quantity. 最小包裝數量請查閱第 18 頁。
- Please refer to page 15 for the Part Number System. 產品編碼規則請查閱第 15 頁。

Note: All design and specifications are for reference only and is subject to change without prior notice. If any doubt about safety for your application, please contact us immediately for technical assistance before purchase.

注：以上所提供的設計及特性參數僅供參考，任何修改不作預先通知。如果在使用上有疑問，請在採購前與我們聯繫，以便提供技術上的協助。

CAT.2023/V2

KH Series

CHIP TYPE, HIGH RELIABILITY

貼片式，高可靠品

- High temperature range up to +125°C
適用於+125°C 的高溫範圍
- Suitable for automotive equipment
適用於汽車電子裝備
- Endurance 1000~5000 hours
耐久性 1000~5000 小時
- RoHS & REACH compliant, Halogen-free
符合 RoHS 與 REACH，無鹵



□ SPECIFICATIONS 特性表

Items 項目	Characteristics 主要特性																																							
Category 工作溫度範圍	-40 ~ +125°C																																							
Voltage Range 額定工作電壓範圍	10 ~ 450V																																							
Capacitance Range 靜電容量範圍	3.3 ~ 4700µF																																							
Capacitance Tolerance 靜電容量允許偏差	±20% at 120Hz, 20°C																																							
Leakage Current 漏電流	Leakage current ≤0.03CV or 4µA (10V~100V), whichever is greater (after 2 minutes application of rated voltage at 20°C) Leakage current ≤0.04CV + 100µA (160V~450V), whichever is greater (after 2 minutes application of rated voltage at 20°C) 漏電流 ≤0.03CV 或 4µA (10V~100V)，取較大值（在 20°C 環境中施加額定工作電壓 2 分鐘後） 漏電流 ≤0.04CV + 100µA (160V~450V)，取較大值（在 20°C 環境中施加額定工作電壓 2 分鐘後）																																							
Dissipation Factor (tan δ) 損耗角正切	C: Nominal capacitance (µF) 標稱靜電容量, V: Rated voltage (V) 額定電壓 Measurement frequency 測試頻率: 120Hz, Temperature 溫度: 20°C <table border="1"> <tr> <td>Rated Voltage (V) 額定工作電壓</td> <td>10</td> <td>16</td> <td>25</td> <td>35</td> <td>50</td> <td>63</td> <td>100</td> <td>160~250</td> <td>400,450</td> </tr> <tr> <td>tan δ (max.) 最大損耗角正切</td> <td>∅4~∅10</td> <td>0.24</td> <td>0.20</td> <td>0.16</td> <td>0.14</td> <td>0.14</td> <td>0.18</td> <td>0.18</td> <td>—</td> </tr> <tr> <td></td> <td>∅12.5~∅18</td> <td>0.22</td> <td>0.18</td> <td>0.16</td> <td>0.14</td> <td>0.12</td> <td>0.14</td> <td>0.10</td> <td>0.20</td> </tr> </table>	Rated Voltage (V) 額定工作電壓	10	16	25	35	50	63	100	160~250	400,450	tan δ (max.) 最大損耗角正切	∅4~∅10	0.24	0.20	0.16	0.14	0.14	0.18	0.18	—		∅12.5~∅18	0.22	0.18	0.16	0.14	0.12	0.14	0.10	0.20									
Rated Voltage (V) 額定工作電壓	10	16	25	35	50	63	100	160~250	400,450																															
tan δ (max.) 最大損耗角正切	∅4~∅10	0.24	0.20	0.16	0.14	0.14	0.18	0.18	—																															
	∅12.5~∅18	0.22	0.18	0.16	0.14	0.12	0.14	0.10	0.20																															
Stability at Low Temperature 低溫特性	Measurement frequency 測試頻率: 120Hz <table border="1"> <tr> <td>Rated Voltage (V) 額定工作電壓</td> <td>10</td> <td>16</td> <td>25</td> <td>35~100</td> <td>160~250</td> <td>400,450</td> </tr> <tr> <td rowspan="2">Impedance Ratio 阻抗比 ZT/Z20 (max.)</td> <td rowspan="2">∅4~∅10</td> <td>Z(-25°C) / Z(20°C)</td> <td>4</td> <td>3</td> <td>2</td> <td>2</td> <td>—</td> <td>—</td> </tr> <tr> <td>Z(-40°C) / Z(20°C)</td> <td>10</td> <td>8</td> <td>6</td> <td>4</td> <td>—</td> <td>—</td> </tr> <tr> <td rowspan="2"></td> <td rowspan="2">∅12.5~∅18</td> <td>Z(-25°C) / Z(20°C)</td> <td>4</td> <td>3</td> <td>2</td> <td>2</td> <td>3</td> <td>6</td> </tr> <tr> <td>Z(-40°C) / Z(20°C)</td> <td>8</td> <td>6</td> <td>4</td> <td>3</td> <td>6</td> <td>10</td> </tr> </table>	Rated Voltage (V) 額定工作電壓	10	16	25	35~100	160~250	400,450	Impedance Ratio 阻抗比 ZT/Z20 (max.)	∅4~∅10	Z(-25°C) / Z(20°C)	4	3	2	2	—	—	Z(-40°C) / Z(20°C)	10	8	6	4	—	—		∅12.5~∅18	Z(-25°C) / Z(20°C)	4	3	2	2	3	6	Z(-40°C) / Z(20°C)	8	6	4	3	6	10
Rated Voltage (V) 額定工作電壓	10	16	25	35~100	160~250	400,450																																		
Impedance Ratio 阻抗比 ZT/Z20 (max.)	∅4~∅10	Z(-25°C) / Z(20°C)	4	3	2	2	—	—																																
		Z(-40°C) / Z(20°C)	10	8	6	4	—	—																																
	∅12.5~∅18	Z(-25°C) / Z(20°C)	4	3	2	2	3	6																																
		Z(-40°C) / Z(20°C)	8	6	4	3	6	10																																
Endurance 耐久性	The characteristics listed below shall be satisfied when the capacitors are restored to 20°C after the rated voltage is applied for the specified time at 125°C. 在 125°C 環境中連續施加規定時間的額定工作電壓後，待溫度恢復至 20°C 時進行測試，電容器的特性符合下表的要求。 <table border="1"> <tr> <td>Size (mm) 尺寸</td> <td>Life time (hours) 壽命 (小時)</td> </tr> <tr> <td>∅6.3</td> <td>1000</td> </tr> <tr> <td>∅D8, ∅10 (10~100V)</td> <td>2000</td> </tr> <tr> <td>∅D12.5~18 (160~450V)</td> <td>2000</td> </tr> <tr> <td>∅D12.5~18 (10~100V)</td> <td>5000</td> </tr> </table> <table border="1"> <tr> <td>Capacitance Change 靜電容量變化率</td> <td>Within ±30% of initial value 初始值的±30%以內</td> </tr> <tr> <td>Dissipation Factor 損耗角正切</td> <td>300% or less of initial specified value 不大於規範值的 300%</td> </tr> <tr> <td>Leakage Current 漏電流</td> <td>initial specified value or less 不大於規範值</td> </tr> </table>	Size (mm) 尺寸	Life time (hours) 壽命 (小時)	∅6.3	1000	∅D8, ∅10 (10~100V)	2000	∅D12.5~18 (160~450V)	2000	∅D12.5~18 (10~100V)	5000	Capacitance Change 靜電容量變化率	Within ±30% of initial value 初始值的±30%以內	Dissipation Factor 損耗角正切	300% or less of initial specified value 不大於規範值的 300%	Leakage Current 漏電流	initial specified value or less 不大於規範值																							
Size (mm) 尺寸	Life time (hours) 壽命 (小時)																																							
∅6.3	1000																																							
∅D8, ∅10 (10~100V)	2000																																							
∅D12.5~18 (160~450V)	2000																																							
∅D12.5~18 (10~100V)	5000																																							
Capacitance Change 靜電容量變化率	Within ±30% of initial value 初始值的±30%以內																																							
Dissipation Factor 損耗角正切	300% or less of initial specified value 不大於規範值的 300%																																							
Leakage Current 漏電流	initial specified value or less 不大於規範值																																							
Shelf Life 高溫貯存特性	After leaving capacitors under no load at 125°C for 1000 hours, they meet the specified value for load life characteristics listed above. 在 125°C 環境中無負荷放置 1000 小時後，電容器的特性符合高溫負荷特性中所列的規定值。																																							
Resistance to Soldering Heat 耐焊接熱特性 (Please refer page 23 for soldering conditions) (焊接條件請查閱第 23 頁)	After reflow soldering and restored at room temperature, they meet the characteristics listed below. 經過回流焊並冷卻至室溫後，電容器的特性符合下表的要求。 <table border="1"> <tr> <td>Capacitance Change 靜電容量變化率</td> <td>Within ±10% of initial value 初始值的±10%以內</td> </tr> <tr> <td>Dissipation Factor 損耗角正切</td> <td>initial specified value or less 不大於規範值</td> </tr> <tr> <td>Leakage Current 漏電流</td> <td>initial specified value or less 不大於規範值</td> </tr> </table>	Capacitance Change 靜電容量變化率	Within ±10% of initial value 初始值的±10%以內	Dissipation Factor 損耗角正切	initial specified value or less 不大於規範值	Leakage Current 漏電流	initial specified value or less 不大於規範值																																	
Capacitance Change 靜電容量變化率	Within ±10% of initial value 初始值的±10%以內																																							
Dissipation Factor 損耗角正切	initial specified value or less 不大於規範值																																							
Leakage Current 漏電流	initial specified value or less 不大於規範值																																							
Marking 標識	Black print on the case top. 鋁殼頂部黑字印刷。																																							

□ DRAWING 外形圖 (Unit: mm)

(∅4~∅6.3×7.7)

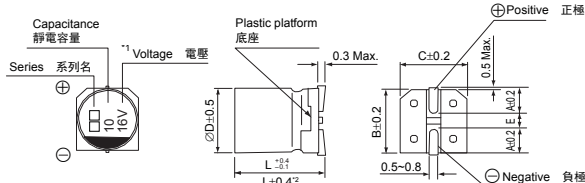

(∅8×10.5~∅18)

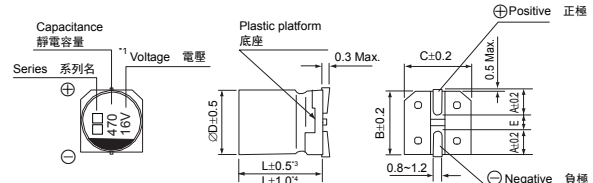

*1. Voltage mark for 6.3V is [6V]
*2. Applicable to ∅6.3×7.7

6.3V 的產品標識為 [6V]
適用於 ∅6.3×7.7

*3. Applicable to ∅8×10.5~∅10
*4. Applicable to ∅12.5~∅18

適用於 ∅8×10.5~∅10
適用於 ∅12.5~∅18

Dimension table in next page.
尺寸表見下一頁。

Note: All design and specifications are for reference only and is subject to change without prior notice. If any doubt about safety for your application, please contact us immediately for technical assistance before purchase.

注: 以上所提供的設計及特性參數僅供參考，任何修改不作預先通知。如果在使用上有疑問，請在採購前與我們聯繫，以便提供技術上的協助。

CAT.2023/V2

KH Series

□ DIMENSIONS (Unit: mm) 尺寸表

∅D x L	4 x 5.8	5 x 5.8	6.3 x 5.8	6.3 x 7.7	8 x 10.5	10 x 10.5	10 x 13.5	12.5 x 13.5	12.5 x 16	16 x 16.5	18 x 16.5
A	2.0	2.2	2.6	2.6	3.0	3.3	3.3	4.9	4.9	5.8	6.2
B	4.3	5.3	6.6	6.6	8.4	10.4	10.4	13.0	13.0	17.0	19.0
C	4.3	5.3	6.6	6.6	8.4	10.4	10.4	13.0	13.0	17.0	19.0
E ± 0.2	1.0	1.4	1.9	1.9	3.1	4.7	4.7	4.7	4.7	6.4	6.4
L	5.8	5.8	5.8	7.7	10.5	10.5	13.5	13.5	16.0	16.5	18.5

□ DIMENSIONS & MAXIMUM PERMISSIBLE RIPPLE CURRENT & ESR 規格尺寸及最大允許紋波電流及 ESR 值

WV Parameter 參數 μF	10 (1A)				16 (1C)				25 (1E)			
	Case size ∅D x L (mm) 尺寸	E.S.R. (Ω) 20°C E.S.R.值	E.S.R. (Ω) -40°C E.S.R.值	Ripple current (mA rms) at 125°C, 100KHz 紋波電流	Case size ∅D x L (mm) 尺寸	E.S.R. (Ω) 20°C E.S.R.值	E.S.R. (Ω) -40°C E.S.R.值	Ripple current (mA rms) at 125°C, 100KHz 紋波電流	Case size ∅D x L (mm) 尺寸	E.S.R. (Ω) 20°C E.S.R.值	E.S.R. (Ω) -40°C E.S.R.值	Ripple current (mA rms) at 125°C, 100KHz 紋波電流
33 330									6.3 x 5.8	3.3	66	45
47 470					6.3 x 5.8	3.3	66	43	6.3 x 7.7	2.3	46	68
100 101	6.3 x 7.7	2.3	46	72	8 x 10.5	1.0	20	115	8 x 10.5	1.0	20	126
220 221	8 x 10.5	1.0	20	136	10 x 10.5	0.7	13.4	175	10 x 10.5	0.7	13.4	211
330 331	10 x 10.5	0.7	13.4	188	10 x 13.5	0.5	9.5	280	12.5 x 13.5 (10 x 13.5)	0.14 (0.5)	2.1 (9.5)	750 (270)
470 471	10 x 13.5	0.5	9.5	300	12.5 x 13.5	0.14	2.1	750	12.5 x 13.5	0.14	2.1	750
680 681					16 x 16.5 (12.5 x 13.5)	0.10 (0.14)	1.5 (2.1)	1000 (750)	16 x 16.5	0.10	1.5	1000
1000 102	12.5 x 16 (12.5 x 13.5)	0.11 (0.14)	1.5 (2.1)	900 (750)	16 x 16.5	0.10	1.5	1000	16 x 16.5	0.10	1.5	1000
2200 222	16 x 16.5	0.10	1.5	1000	18 x 16.5	0.09	1.5	1100				
3300 332	18 x 16.5	0.09	1.5	1100								
4700 472	18 x 16.5	0.09	1.5	1100								

WV Parameter 參數 μF	35 (1V)				50 (1H)			
	Case size ∅D x L (mm) 尺寸	E.S.R. (Ω) 20°C E.S.R.值	E.S.R. (Ω) -40°C E.S.R.值	Ripple current (mA rms) at 125°C, 100KHz 紋波電流	Case size ∅D x L (mm) 尺寸	E.S.R. (Ω) 20°C E.S.R.值	E.S.R. (Ω) -40°C E.S.R.值	Ripple current (mA rms) at 125°C, 100KHz 紋波電流
10 100	6.3 x 5.8	3.3	66	38	6.3 x 7.7 (6.3 x 5.8)	2.3 (3.3)	46 (66)	50 (38)
22 220	6.3 x 5.8	3.3	66	39	6.3 x 7.7	2.3	46	50
33 330	6.3 x 7.7	2.3	46	62	8 x 10.5	1.0	20	83
47 470	8 x 10.5	1.0	20	92	10 x 10.5	0.7	13.4	111
100 101	10 x 10.5	0.7	13.4	151	12.5 x 13.5 (10 x 10.5) (10 x 13.5)	0.23 (0.7) (0.5)	3.5 (13.4) (12)	550 (151) (260)
220 221	12.5 x 13.5 (10 x 13.5)	0.14 (0.5)	2.1 (9.5)	750 (260)	16 x 16.5 (12.5 x 13.5)	0.15 (0.23)	2.3 (3.5)	850 (550)
330 331	12.5 x 13.5	0.14	2.1	750	16 x 16.5 (12.5 x 16)	0.15 (0.18)	2.3 (2.7)	850 (700)
470 471	16 x 16.5 (12.5 x 16)	0.10 (0.11)	1.5 (1.5)	1000 (900)	16 x 16.5	0.15	2.3	850
1000 102	18 x 16.5	0.10	1.5	1000				

WV Parameter 參數 μF	63 (1J)				100 (2A)			
	Case size ∅D x L (mm) 尺寸	E.S.R. (Ω) 20°C E.S.R.值	E.S.R. (Ω) -40°C E.S.R.值	Ripple current (mA rms) at 125°C, 100KHz 紋波電流	Case size ∅D x L (mm) 尺寸	E.S.R. (Ω) 20°C E.S.R.值	E.S.R. (Ω) -40°C E.S.R.值	Ripple current (mA rms) at 125°C, 100KHz 紋波電流
10 100	6.3 x 7.7	2.3	115	42	8 x 10.5	1.00	50	53
22 220	8 x 10.5	1.0	50	56	10 x 10.5	0.70	35	63
33 330	10 x 10.5	0.7	35	77	10 x 13.5	0.45	22.5	130
47 470	10 x 13.5 (10 x 10.5)	0.45 (0.7)	22.5 (35)	150 (125)	12.5 x 13.5	0.33	16.5	450
68 680					12.5 x 16	0.26	13	550
100 101	12.5 x 13.5	0.25	12.5	500	16 x 16.5	0.24	12	650
220 221	12.5 x 16	0.20	10	600				
330 331	16 x 16.5	0.18	9	820				

Note: All design and specifications are for reference only and is subject to change without prior notice. If any doubt about safety for your application, please contact us immediately for technical assistance before purchase.

注：以上所提供的設計及特性參數僅供參考，任何修改不作預先通知。如果在使用上有疑問，請在採購前與我們聯繫，以便提供技術上的協助。

CAT.2023/V2

KH Series

□ DIMENSIONS & MAXIMUM PERMISSIBLE RIPPLE CURRENT 規格尺寸及最大允許紋波電流

μF	WV Code 代碼	160		200		250		400		450	
		2C		2D		2E		2G		2W	
3.3	3R3									12.5 × 16	65
4.7	4R7							12.5 × 13.5	70	16 × 16.5	85
6.8	6R8							16 × 16.5	100		
10	100	12.5 × 13.5	100	12.5 × 13.5	100	12.5 × 16	110			Case size 尺寸	Ripple current 紋波電流
22	220	16 × 16.5	180	16 × 16.5	180						

•Case size $\varnothing D \times L$ (mm), ripple current (mA rms) at 125°C, 120Hz •尺寸 $\varnothing D \times L$ (mm), 紋波電流(mA rms)於 125°C, 120Hz

□ FREQUENCY COEFFICIENT OF ALLOWABLE RIPPLE CURRENT 紋波電流頻率補償系數

Frequency 頻率		50Hz	120Hz	1KHz	10KHz~	100KHz~	
Coefficient 系數	10~100V	10 ~ 100μF	0.35	0.40	0.75	0.90	1.00
		220 ~ 470μF	0.35	0.50	0.85	0.94	1.00
		680 ~ 2200μF	0.40	0.60	0.85	0.95	1.00

Frequency 頻率		50Hz	120Hz	300Hz	1KHz	10KHz	100KHz~
Coefficient 系數	160~450V	0.75	1.00	1.25	1.50	1.75	1.80

The endurance of capacitors is reduced with internal heating produced by ripple current at the rate of halving the lifetime with every 5~10°C rise. When long life performance is required in actual use, the rms ripple current has to be reduced. 鋁電解電容器在疊加紋波電流後會引起發熱，溫度每上升 5~10°C 壽命會減半。若要保持長壽命性能，請在使用過程中適當降低紋波電流。

- Taping specifications are given in page 17. 編帶標準請查閱第 17 頁。
- Soldering conditions and recommended land size are given in page 23. 焊接條件及推薦安裝尺寸請查閱第 23 頁。
- Please refer to page 18 for the minimum package quantity. 最小包裝數量請查閱第 18 頁。
- Please refer to page 15 for the Part Number System. 產品編碼規則請查閱第 15 頁。

Note: All design and specifications are for reference only and is subject to change without prior notice. If any doubt about safety for your application, please contact us immediately for technical assistance before purchase.

注：以上所提供的設計及特性參數僅供參考，任何修改不作預先通知。如果在使用上有疑問，請在採購前與我們聯繫，以便提供技術上的協助。

CAT.2023/V2

CP Series

CHIP TYPE, HIGH VOLTAGE, 3000 HOURS LOAD LIFE

貼片式, 3000 小時, 高壓長壽命品

- Operating with wide temperature range -40~+85°C
適用於 -40~+85°C 的寬溫範圍
- Endurance 3000 hours
耐久性 3000 小時
- RoHS & REACH compliant, Halogen-free
符合 RoHS 與 REACH, 無鹵

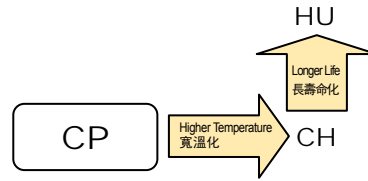

□ SPECIFICATIONS 特性表

Items 項目	Characteristics 主要特性															
Category Temperature Range 工作溫度範圍	-55 ~ +85°C															
Voltage Range 額定工作電壓範圍	160 ~ 450V															
Capacitance Range 靜電容量範圍	3.3 ~ 100μF															
Capacitance Tolerance 靜電容量允許偏差	±20% at 120Hz, 20°C															
Leakage Current 漏電流	Leakage current $\leq 0.04CV + 100\mu A$, whichever is greater (after 2 minutes application of rated voltage at 20°C) 漏電流 $\leq 0.04CV + 100\mu A$, 取較大值 (在 20°C 環境中施加額定工作電壓 2 分鐘後) C: Nominal capacitance (μF) 標稱靜電容量, V: Rated voltage (V) 額定電壓															
Dissipation Factor (tan δ) 損耗角正切	Measurement frequency 測試頻率: 120Hz, Temperature 溫度: 20°C <table border="1"> <tr> <td>Rated Voltage (V) 額定工作電壓</td> <td>160 ~ 250</td> <td>400, 500</td> </tr> <tr> <td>tan δ (max.) 最大損耗角正切</td> <td>0.20</td> <td>0.25</td> </tr> </table>	Rated Voltage (V) 額定工作電壓	160 ~ 250	400, 500	tan δ (max.) 最大損耗角正切	0.20	0.25									
Rated Voltage (V) 額定工作電壓	160 ~ 250	400, 500														
tan δ (max.) 最大損耗角正切	0.20	0.25														
Stability at Low Temperature 低溫特性	Measurement frequency 測試頻率: 120Hz <table border="1"> <tr> <td>Rated Voltage (V) 額定工作電壓</td> <td>160 ~ 250</td> <td>400, 500</td> </tr> <tr> <td>Impedance Ratio 阻抗比</td> <td>Z(-25°C) / Z(20°C)</td> <td>2</td> </tr> <tr> <td>ZT/Z20 (max.)</td> <td>Z(-40°C) / Z(20°C)</td> <td>6</td> </tr> <tr> <td></td> <td></td> <td>4</td> </tr> <tr> <td></td> <td></td> <td>10</td> </tr> </table>	Rated Voltage (V) 額定工作電壓	160 ~ 250	400, 500	Impedance Ratio 阻抗比	Z(-25°C) / Z(20°C)	2	ZT/Z20 (max.)	Z(-40°C) / Z(20°C)	6			4			10
Rated Voltage (V) 額定工作電壓	160 ~ 250	400, 500														
Impedance Ratio 阻抗比	Z(-25°C) / Z(20°C)	2														
ZT/Z20 (max.)	Z(-40°C) / Z(20°C)	6														
		4														
		10														
Endurance 耐久性	After 3000 hours application of the rated voltage at 85°C, they meet the characteristics listed below. 在 85°C 環境中施加額定工作電壓 3000 小時後, 電容器的特性符合下表的要求。 <table border="1"> <tr> <td>Capacitance Change 靜電容量變化率</td> <td>Within ±20% of initial value 初始值的±20%以內</td> </tr> <tr> <td>Dissipation Factor 損耗角正切</td> <td>200% or less of initial specified value 不大於規範值的 200%</td> </tr> <tr> <td>Leakage Current 漏電流</td> <td>initial specified value or less 不大於規範值</td> </tr> </table>	Capacitance Change 靜電容量變化率	Within ±20% of initial value 初始值的±20%以內	Dissipation Factor 損耗角正切	200% or less of initial specified value 不大於規範值的 200%	Leakage Current 漏電流	initial specified value or less 不大於規範值									
Capacitance Change 靜電容量變化率	Within ±20% of initial value 初始值的±20%以內															
Dissipation Factor 損耗角正切	200% or less of initial specified value 不大於規範值的 200%															
Leakage Current 漏電流	initial specified value or less 不大於規範值															
Shelf Life 高溫貯存特性	After leaving capacitors under no load at 85°C for 1000 hours, they meet the specified value for load life characteristics listed above. 在 85°C 環境中無負荷放置 1000 小時後, 電容器的特性符合高溫負荷特性中所列的規定值。															
Resistance to Soldering Heat 耐焊接熱特性 (Please refer page 23 for soldering conditions) (焊接條件請查閱第 23 頁)	After reflow soldering and restored at room temperature, they meet the characteristics listed below. 經過回流焊並冷卻至室溫後, 電容器的特性符合下表的要求。 <table border="1"> <tr> <td>Capacitance Change 靜電容量變化率</td> <td>Within ±10% of initial value 初始值的±10%以內</td> </tr> <tr> <td>Dissipation Factor 損耗角正切</td> <td>initial specified value or less 不大於規範值</td> </tr> <tr> <td>Leakage Current 漏電流</td> <td>initial specified value or less 不大於規範值</td> </tr> </table>	Capacitance Change 靜電容量變化率	Within ±10% of initial value 初始值的±10%以內	Dissipation Factor 損耗角正切	initial specified value or less 不大於規範值	Leakage Current 漏電流	initial specified value or less 不大於規範值									
Capacitance Change 靜電容量變化率	Within ±10% of initial value 初始值的±10%以內															
Dissipation Factor 損耗角正切	initial specified value or less 不大於規範值															
Leakage Current 漏電流	initial specified value or less 不大於規範值															
Marking 標識	Black print on the case top. 鋁殼頂部黑字印刷。															

□ DRAWING 外形圖 (Unit: mm)

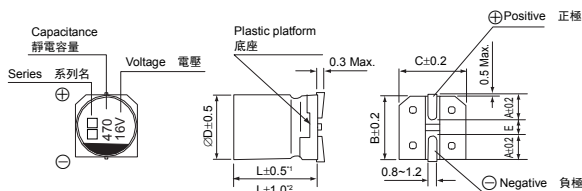

● A pressure relief vent is attached to products over $\varnothing D=12.5$
 $\varnothing D=12.5$ 以上產品有緩壓防爆閥

*1. Applicable to $\varnothing 8 \times 10.5 \sim \varnothing 10$
 *2. Applicable to $\varnothing 12.5 \sim \varnothing 18$

適用於 $\varnothing 10$
 適用於 $\varnothing 12.5 \sim \varnothing 18$

□ DIMENSIONS (Unit: mm) 尺寸表

ØD x L	10 x 13.5	12.5 x 13.5	12.5 x 16	16 x 16.5
A	3.3	4.9	4.9	5.8
B	10.4	13.0	13.0	17.0
C	10.4	13.0	13.0	17.0
E ± 0.2	4.7	4.7	4.7	6.4
L	13.5	13.5	16.0	16.5

Note: All design and specifications are for reference only and is subject to change without prior notice. If any doubt about safety for your application, please contact us immediately for technical assistance before purchase.

注: 以上所提供的設計及特性參數僅供參考, 任何修改不作預先通知。如果在使用上有疑問, 請在採購前與我們聯繫, 以便提供技術上的協助。

CAT.2023/V2

CP Series

□ DIMENSIONS & MAXIMUM PERMISSIBLE RIPPLE CURRENT 規格尺寸及最大允許紋波電流

WV Code 代碼		160		200		250		350	
μF		2C		2D		2E		2V	
4.7	4R7					10 × 13.5	65	10 × 13.5	85
10	100			10 × 13.5	75	10 × 13.5	75	12.5 × 13.5	105
22	220	10 × 13.5	50	12.5 × 13.5	105	12.5 × 13.5	105	16 × 16.5	130
33	330	12.5 × 13.5	95	12.5 × 13.5	120	16 × 16.5	135		
47	470	12.5 × 13.5 (16 × 16.5)	205 (240)			16 × 16.5	220	Case size 尺寸	Ripple current 紋波電流
100	101	16 × 16.5	250						

WV Code 代碼		400		450	
μF		2G		2W	
3.3	3R3	8 × 13.5 (10 × 13.5)	35 (40)	8 × 13.5 (10 × 13.5)	35 (40)
4.7	4R7	10 × 13.5	45	10 × 13.5	42
10	100	12.5 × 13.5	50	12.5 × 13.5	55
22	220	16 × 16.5	85	16 × 16.5	85
				Case size 尺寸	Ripple current 紋波電流

• Case size $\varnothing D \times L$ (mm), ripple current (mA rms) at 85°C, 120Hz • 尺寸 $\varnothing D \times L$ (mm), 紋波電流 (mA rms) 於 85°C, 120Hz

□ FREQUENCY COEFFICIENT OF ALLOWABLE RIPPLE CURRENT 紋波電流頻率補償系數

Frequency 頻率	50Hz	120Hz	300Hz	1KHz	10KHz~
Coefficient 系數	0.75	1.00	1.35	1.57	2.00

The endurance of capacitors is reduced with internal heating produced by ripple current at the rate of halving the lifetime with every 5~10°C rise. When long life performance is required in actual use, the rms ripple current has to be reduced. 鋁電解電容器在疊加紋波電流後會引起發熱，溫度每上升 5~10°C 壽命會減半。若要保持長壽命性能，請在使用過程中適當降低紋波電流。

- Taping specifications are given in page 17. 編帶標準請查閱第 17 頁。
- Soldering conditions and recommended land size are given in page 23. 焊接條件及推薦安裝尺寸請查閱第 23 頁。
- Please refer to page 18 for the minimum package quantity. 最小包裝數量請查閱第 18 頁。
- Please refer to page 15 for the Part Number System. 產品編碼規則請查閱第 15 頁。

Note: All design and specifications are for reference only and is subject to change without prior notice. If any doubt about safety for your application, please contact us immediately for technical assistance before purchase.

注：以上所提供的設計及特性參數僅供參考，任何修改不作預先通知。如果在使用上有疑問，請在採購前與我們聯繫，以便提供技術上的協助。

CAT.2023/V2

CH Series

CHIP TYPE, HIGH VOLTAGE, 3000 HOURS LOAD LIFE

貼片式, 3000 小時, 高壓長壽命品

- Operating with wide temperature range -55~+105°C
適用於 -55~+105°C 的寬溫範圍
- Endurance 3000 hours
耐久性 3000 小時
- RoHS & REACH compliant, Halogen-free
符合 RoHS 與 REACH, 無鹵

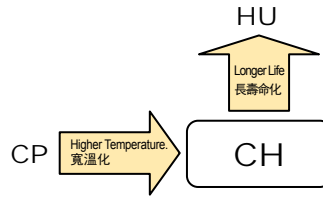

□ SPECIFICATIONS 特性表

Items 項目	Characteristics 主要特性															
Category Temperature Range 工作溫度範圍	-55 ~ +105°C															
Voltage Range 額定工作電壓範圍	160 ~ 450V															
Capacitance Range 靜電容量範圍	3.3 ~ 100μF															
Capacitance Tolerance 靜電容量允許偏差	±20% at 120Hz, 20°C															
Leakage Current 漏電流	Leakage current $\leq 0.04CV + 100\mu A$, whichever is greater (after 2 minutes application of rated voltage at 20°C) 漏電流 $\leq 0.04CV + 100\mu A$, 取較大值 (在 20°C 環境中施加額定工作電壓 2 分鐘後) C: Nominal capacitance (μF) 標稱靜電容量, V: Rated voltage (V) 額定電壓															
Dissipation Factor (tan δ) 損耗角正切	Measurement frequency 測試頻率: 120Hz, Temperature 溫度: 20°C <table border="1"> <tr> <td>Rated Voltage (V) 額定工作電壓</td> <td>160 ~ 250</td> <td>400, 500</td> </tr> <tr> <td>tan δ (max.) 最大損耗角正切</td> <td>0.20</td> <td>0.25</td> </tr> </table>	Rated Voltage (V) 額定工作電壓	160 ~ 250	400, 500	tan δ (max.) 最大損耗角正切	0.20	0.25									
Rated Voltage (V) 額定工作電壓	160 ~ 250	400, 500														
tan δ (max.) 最大損耗角正切	0.20	0.25														
Stability at Low Temperature 低溫特性	Measurement frequency 測試頻率: 120Hz <table border="1"> <tr> <td>Rated Voltage (V) 額定工作電壓</td> <td>160 ~ 250</td> <td>400, 500</td> </tr> <tr> <td>Impedance Ratio 阻抗比</td> <td>Z(-25°C) / Z(20°C)</td> <td>2</td> </tr> <tr> <td>ZT/Z20 (max.)</td> <td>Z(-55°C) / Z(20°C)</td> <td>6</td> </tr> <tr> <td></td> <td></td> <td>4</td> </tr> <tr> <td></td> <td></td> <td>10</td> </tr> </table>	Rated Voltage (V) 額定工作電壓	160 ~ 250	400, 500	Impedance Ratio 阻抗比	Z(-25°C) / Z(20°C)	2	ZT/Z20 (max.)	Z(-55°C) / Z(20°C)	6			4			10
Rated Voltage (V) 額定工作電壓	160 ~ 250	400, 500														
Impedance Ratio 阻抗比	Z(-25°C) / Z(20°C)	2														
ZT/Z20 (max.)	Z(-55°C) / Z(20°C)	6														
		4														
		10														
Endurance 耐久性	After 3000 hours application of the rated voltage at 105°C, they meet the characteristics listed below. 在 105°C 環境中施加額定工作電壓 3000 小時後, 電容器的特性符合下表的要求。 <table border="1"> <tr> <td>Capacitance Change 靜電容量變化率</td> <td>Within $\pm 20\%$ of initial value 初始值的$\pm 20\%$以內</td> </tr> <tr> <td>Dissipation Factor 損耗角正切</td> <td>200% or less of initial specified value 不大於規範值的 200%</td> </tr> <tr> <td>Leakage Current 漏電流</td> <td>initial specified value or less 不大於規範值</td> </tr> </table>	Capacitance Change 靜電容量變化率	Within $\pm 20\%$ of initial value 初始值的 $\pm 20\%$ 以內	Dissipation Factor 損耗角正切	200% or less of initial specified value 不大於規範值的 200%	Leakage Current 漏電流	initial specified value or less 不大於規範值									
Capacitance Change 靜電容量變化率	Within $\pm 20\%$ of initial value 初始值的 $\pm 20\%$ 以內															
Dissipation Factor 損耗角正切	200% or less of initial specified value 不大於規範值的 200%															
Leakage Current 漏電流	initial specified value or less 不大於規範值															
Shelf Life 高溫貯存特性	After leaving capacitors under no load at 105°C for 1000 hours, they meet the specified value for load life characteristics listed above. 在 105°C 環境中無負荷放置 1000 小時後, 電容器的特性符合高溫負荷特性中所列的規定值。															
Resistance to Soldering Heat 耐焊接熱特性 (Please refer page 23 for soldering conditions) (焊接條件請查閱第 23 頁)	After reflow soldering and restored at room temperature, they meet the characteristics listed below. 經過回流焊並冷卻至室溫後, 電容器的特性符合下表的要求。 <table border="1"> <tr> <td>Capacitance Change 靜電容量變化率</td> <td>Within $\pm 10\%$ of initial value 初始值的$\pm 10\%$以內</td> </tr> <tr> <td>Dissipation Factor 損耗角正切</td> <td>initial specified value or less 不大於規範值</td> </tr> <tr> <td>Leakage Current 漏電流</td> <td>initial specified value or less 不大於規範值</td> </tr> </table>	Capacitance Change 靜電容量變化率	Within $\pm 10\%$ of initial value 初始值的 $\pm 10\%$ 以內	Dissipation Factor 損耗角正切	initial specified value or less 不大於規範值	Leakage Current 漏電流	initial specified value or less 不大於規範值									
Capacitance Change 靜電容量變化率	Within $\pm 10\%$ of initial value 初始值的 $\pm 10\%$ 以內															
Dissipation Factor 損耗角正切	initial specified value or less 不大於規範值															
Leakage Current 漏電流	initial specified value or less 不大於規範值															
Marking 標識	Black print on the case top. 鋁殼頂部黑字印刷。															

□ DRAWING 外形圖 (Unit: mm)

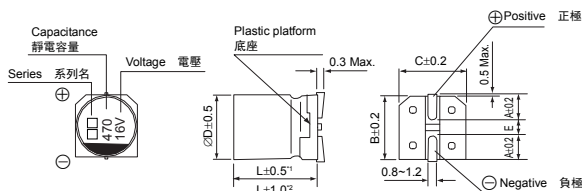

• A pressure relief vent is attached to products over $\varnothing D=12.5$
 $\varnothing D=12.5$ 以上產品有緩壓防爆閥

*1. Applicable to $\varnothing 8 \times 10.5 \sim \varnothing 10$
 *2. Applicable to $\varnothing 12.5 \sim \varnothing 18$

適用於 $\varnothing 10$
 適用於 $\varnothing 12.5 \sim \varnothing 18$

□ DIMENSIONS 尺寸表 (Unit: mm)

$\varnothing D \times L$	10 x 13.5	12.5 x 13.5	12.5 x 16	16 x 16.5
A	3.3	4.9	4.9	5.8
B	10.4	13.0	13.0	17.0
C	10.4	13.0	13.0	17.0
E ± 0.2	4.7	4.7	4.7	6.4
L	13.5	13.5	16.0	16.5

Note: All design and specifications are for reference only and is subject to change without prior notice. If any doubt about safety for your application, please contact us immediately for technical assistance before purchase.

注: 以上所提供的設計及特性參數僅供參考, 任何修改不作預先通知。如果在使用上有疑問, 請在採購前與我們聯繫, 以便提供技術上的協助。

CAT.2023/V2

CH Series

□ DIMENSIONS & MAXIMUM PERMISSIBLE RIPPLE CURRENT 規格尺寸及最大允許紋波電流

WV Code 代碼		160		200		250		350	
μF		2C		2D		2E		2V	
4.7	4R7					10 × 13.5	65	10 × 13.5	85
10	100			10 × 13.5	75	10 × 13.5	75	12.5 × 13.5	105
22	220	10 × 13.5	50	12.5 × 13.5	105	12.5 × 13.5	105	16 × 16.5	130
33	330	12.5 × 13.5	95	12.5 × 13.5	120	16 × 16.5	135		
47	470	12.5 × 13.5 (16 × 16.5)	205 (240)			16 × 16.5	220	Case size 尺寸	Ripple current 紋波電流
100	101	16 × 16.5	250	16 × 16.5	250				

WV Code 代碼		400		450	
μF		2G		2W	
3.3	3R3	8 × 13.5 (10 × 13.5)	35 (40)	8 × 13.5 (10 × 13.5)	35 (40)
4.7	4R7	10 × 13.5	45	10 × 13.5 (12.5 × 13.5)	42 (45)
10	100	12.5 × 13.5	50	12.5 × 13.5	55
22	220	16 × 16.5	85	16 × 16.5	85
33	330	16 × 16.5	100	16 × 16.5	100
				Case size 尺寸	Ripple current 紋波電流

•Case size $\varnothing D \times L$ (mm), ripple current (mA rms) at 105°C, 120Hz •尺寸 $\varnothing D \times L$ (mm), 紋波電流(mA rms)於 105°C, 120Hz

□ FREQUENCY COEFFICIENT OF ALLOWABLE RIPPLE CURRENT 紋波電流頻率補償系數

Frequency 頻率	50Hz	120Hz	300Hz	1KHz	10KHz~
Coefficient 系數	0.75	1.00	1.35	1.57	2.00

The endurance of capacitors is reduced with internal heating produced by ripple current at the rate of halving the lifetime with every 5~10°C rise. When long life performance is required in actual use, the rms ripple current has to be reduced. 鋁電解電容器在疊加紋波電流後會引起發熱，溫度每上升 5~10°C 壽命會減半。若要保持長壽命性能，請在使用過程中適當降低紋波電流。

- Taping specifications are given in page 17. 編帶標準請查閱第 17 頁。
- Soldering conditions and recommended land size are given in page 23. 焊接條件及推薦安裝尺寸請查閱第 23 頁。
- Please refer to page 18 for the minimum package quantity. 最小包裝數量請查閱第 18 頁。
- Please refer to page 15 for the Part Number System. 產品編碼規則請查閱第 15 頁。

Note: All design and specifications are for reference only and is subject to change without prior notice. If any doubt about safety for your application, please contact us immediately for technical assistance before purchase.

注：以上所提供的設計及特性參數僅供參考，任何修改不作預先通知。如果在使用上有疑問，請在採購前與我們聯繫，以便提供技術上的協助。

CAT.2023/V2

HU Series

CHIP TYPE, HIGH VOLTAGE, LONG LIFE

貼片式，高壓長壽命品



- Operating with wide temperature range -40~+105°C
適用於 -40~+105°C 的寬溫範圍
- Endurance 5000 hours
耐久性 5000 小時
- RoHS & REACH compliant, Halogen-free
符合 RoHS 與 REACH，無鹵

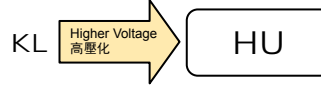

□ SPECIFICATIONS 特性表

Items 項目	Characteristics 主要特性											
Category Temperature Range 工作溫度範圍	-40 ~ +105°C											
Voltage Range 額定工作電壓範圍	160 ~ 450V											
Capacitance Range 靜電容量範圍	3.3 ~ 47μF											
Capacitance Tolerance 靜電容量允許偏差	±20% at 120Hz, 20°C											
Leakage Current 漏電流	Leakage current $\leq 0.04CV + 100\mu A$, whichever is greater (after 2 minutes application of rated voltage at 20°C) 漏電流 $\leq 0.04CV + 100\mu A$ ，取較大值（在 20°C 環境中施加額定工作電壓 2 分鐘後） C: Nominal capacitance (μF) 標稱靜電容量, V: Rated voltage (V) 額定電壓											
Dissipation Factor (tan δ) 損耗角正切	Measurement frequency 測試頻率: 120Hz, Temperature 溫度: 20°C <table border="1"> <tr> <td>Rated Voltage (V) 額定工作電壓</td> <td>160~250</td> <td>400, 500</td> </tr> <tr> <td>tan δ (max.) 最大損耗角正切</td> <td>0.15</td> <td>0.20</td> </tr> </table>	Rated Voltage (V) 額定工作電壓	160~250	400, 500	tan δ (max.) 最大損耗角正切	0.15	0.20					
Rated Voltage (V) 額定工作電壓	160~250	400, 500										
tan δ (max.) 最大損耗角正切	0.15	0.20										
Stability at Low Temperature 低溫特性	Measurement frequency 測試頻率: 120Hz <table border="1"> <tr> <td>Rated Voltage (V) 額定工作電壓</td> <td>160~250</td> <td>400, 500</td> </tr> <tr> <td>Impedance Ratio 阻抗比</td> <td>Z(-25°C) / Z(20°C)</td> <td>3</td> <td>6</td> </tr> <tr> <td>ZT/Z20 (max.)</td> <td>Z(-40°C) / Z(20°C)</td> <td>6</td> <td>10</td> </tr> </table>	Rated Voltage (V) 額定工作電壓	160~250	400, 500	Impedance Ratio 阻抗比	Z(-25°C) / Z(20°C)	3	6	ZT/Z20 (max.)	Z(-40°C) / Z(20°C)	6	10
Rated Voltage (V) 額定工作電壓	160~250	400, 500										
Impedance Ratio 阻抗比	Z(-25°C) / Z(20°C)	3	6									
ZT/Z20 (max.)	Z(-40°C) / Z(20°C)	6	10									
Endurance 耐久性	After 5000 hours application of the rated voltage at 105°C, they meet the characteristics listed below. 在 105°C 環境中施加額定工作電壓 5000 小時後，電容器的特性符合下表的要求。 <table border="1"> <tr> <td>Capacitance Change 靜電容量變化率</td> <td>Within ±20% of initial value 初始值的±20%以內</td> </tr> <tr> <td>Dissipation Factor 損耗角正切</td> <td>200% or less of initial specified value 不大於規範值的 200%</td> </tr> <tr> <td>Leakage Current 漏電流</td> <td>initial specified value or less 不大於規範值</td> </tr> </table>	Capacitance Change 靜電容量變化率	Within ±20% of initial value 初始值的±20%以內	Dissipation Factor 損耗角正切	200% or less of initial specified value 不大於規範值的 200%	Leakage Current 漏電流	initial specified value or less 不大於規範值					
Capacitance Change 靜電容量變化率	Within ±20% of initial value 初始值的±20%以內											
Dissipation Factor 損耗角正切	200% or less of initial specified value 不大於規範值的 200%											
Leakage Current 漏電流	initial specified value or less 不大於規範值											
Shelf Life 高溫貯存特性	After leaving capacitors under no load at 105°C for 1000 hours, they meet the specified value for load life characteristics listed above. 在 105°C 環境中無負荷放置 1000 小時後，電容器的特性符合高溫負荷特性中所列的規定值。											
Resistance to Soldering Heat 耐焊接熱特性 (Please refer page 23 for soldering conditions) (焊接條件請查閱第 23 頁)	After reflow soldering and restored at room temperature, they meet the characteristics listed below. 經過回流焊並冷卻至室溫後，電容器的特性符合下表的要求。 <table border="1"> <tr> <td>Capacitance Change 靜電容量變化率</td> <td>Within ±10% of initial value 初始值的±10%以內</td> </tr> <tr> <td>Dissipation Factor 損耗角正切</td> <td>initial specified value or less 不大於規範值</td> </tr> <tr> <td>Leakage Current 漏電流</td> <td>initial specified value or less 不大於規範值</td> </tr> </table>	Capacitance Change 靜電容量變化率	Within ±10% of initial value 初始值的±10%以內	Dissipation Factor 損耗角正切	initial specified value or less 不大於規範值	Leakage Current 漏電流	initial specified value or less 不大於規範值					
Capacitance Change 靜電容量變化率	Within ±10% of initial value 初始值的±10%以內											
Dissipation Factor 損耗角正切	initial specified value or less 不大於規範值											
Leakage Current 漏電流	initial specified value or less 不大於規範值											
Marking 標識	Black print on the case top. 鋁殼頂部黑字印刷。											

□ DRAWING 外形圖 (Unit: mm)

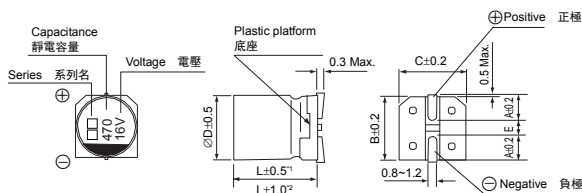

● A pressure relief vent is attached to products over $\varnothing D=12.5$
 $\varnothing D=12.5$ 以上產品有緩壓防爆閥

*1. Applicable to $\varnothing 8 \times 10.5 \sim \varnothing 10$
 *2. Applicable to $\varnothing 12.5 \sim \varnothing 18$

適用於 $\varnothing 10$
 適用於 $\varnothing 12.5 \sim \varnothing 18$

□ DIMENSIONS (Unit: mm) 尺寸表

$\varnothing D \times L$	8 x 12.5	10 x 10.5/13.5	12.5 x 13.5	12.5 x 16
A	3.0	3.3	4.9	4.9
B	8.4	10.4	13.0	13.0
C	8.4	10.4	13.0	13.0
E ± 0.2	3.1	4.7	4.7	4.7
L	12.5	13.5	13.5	16.0

Note: All design and specifications are for reference only and is subject to change without prior notice. If any doubt about safety for your application, please contact us immediately for technical assistance before purchase.

注：以上所提供的設計及特性參數僅供參考，任何修改不作預先通知。如果在使用上有疑問，請在採購前與我們聯繫，以便提供技術上的協助。

CAT.2023/V2

HU Series

□ DIMENSIONS & MAXIMUM PERMISSIBLE RIPPLE CURRENT 規格尺寸及最大允許紋波電流

μF	WV Code 代碼	160		200		250		400		450	
		2C		2D		2E		2G		2W	
3.3	3R3									10 × 13.5	40
4.7	4R7					10 × 10.5	65	8 × 12.5 (10 × 10.5) (10 × 13.5)	45 (48) (50)	10 × 13.5	50
6.8	6R8					10 × 10.5	70	10 × 10.5 (10 × 13.5)	45 (60)	10 × 13.5	50
10	100			10 × 10.5 (10 × 13.5)	70 (80)	10 × 13.5	105	10 × 13.5 (12.5 × 13.5)	65 (85)	12.5 × 13.5	85
22	220	12.5 × 13.5	85	10 × 13.5 (12.5 × 13.5)	95 (110)	12.5 × 13.5 (12.5 × 16)	120 (180)	16 × 16.5	95		
33	330	12.5 × 13.5	95	12.5 × 16	220					Case size 尺寸	Ripple current 紋波電流
47	470	12.5 × 13.5 (12.5 × 16)	110 (260)								

•Case size $\varnothing D \times L$ (mm), ripple current (mA rms) at 105°C, 120Hz •尺寸 $\varnothing D \times L$ (mm), 紋波電流(mA rms)於 105°C, 120Hz

□ FREQUENCY COEFFICIENT OF ALLOWABLE RIPPLE CURRENT 紋波電流頻率補償系數

Frequency 頻率	50Hz	120Hz	300Hz	1KHz	10KHz~
Coefficient 系數	0.80	1.00	1.25	1.40	1.60

The endurance of capacitors is reduced with internal heating produced by ripple current at the rate of halving the lifetime with every 5~10°C rise. When long life performance is required in actual use, the rms ripple current has to be reduced. 鋁電解電容器在疊加紋波電流後會引起發熱，溫度每上升 5~10°C 壽命會減半。若要保持長壽命性能，請在使用過程中適當降低紋波電流。

- Taping specifications are given in page 17. 編帶標準請查閱第 17 頁。
- Soldering conditions and recommended land size are given in page 23. 焊接條件及推薦安裝尺寸請查閱第 23 頁。
- Please refer to page 18 for the minimum package quantity. 最小包裝數量請查閱第 18 頁。
- Please refer to page 15 for the Part Number System. 產品編碼規則請查閱第 15 頁。

Note: All design and specifications are for reference only and is subject to change without prior notice. If any doubt about safety for your application, please contact us immediately for technical assistance before purchase.

注：以上所提供的設計及特性參數僅供參考，任何修改不作預先通知。如果在使用上有疑問，請在採購前與我們聯繫，以便提供技術上的協助。

CAT.2023/V2

Aluminum Electrolytic Capacitors (Radial Lead Type)
鋁電解電容器 (引線式)



Note: All design and specifications are for reference only and is subject to change without prior notice. If any doubt about safety for your application, please contact us immediately for technical assistance before purchase.

注：以上所提供的設計及特性參數僅供參考，任何修改不作預先通知。如果在使用上有疑問，請在採購前與我們聯繫，以便提供技術上的協助。

CAT.2023/V2

RA Series

STANDARD

標準品

- Standard series for general purpose
標準品通用型
- High performance and high reliability
高性能與高可靠
- Endurance 2000 hours at 85°C
在 85°C 環境中耐久性 2000 小時
- Comply with the RoHS & REACH
符合 RoHS 與 REACH

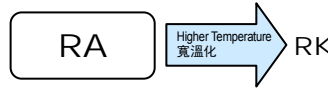
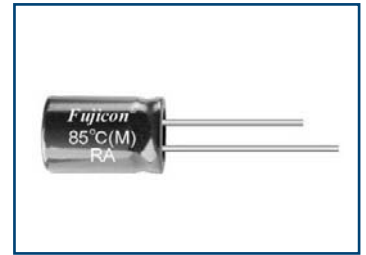

SPECIFICATIONS 特性表

Items 項目	Characteristics 主要特性	
Category Temperature Range 工作溫度範圍	-40 ~ +85°C	-25 ~ +85°C
Voltage Range 額定工作電壓範圍	6.3 ~ 100V	160 ~ 450V
Capacitance Range 靜電容量範圍	0.1 ~ 22000µF	0.47 ~ 470µF
Capacitance Tolerance 靜電容量允許偏差	±20% at 120Hz, 20°C	
Leakage Current 漏電流	Leakage current ≤0.01CV or 3µA, whichever is greater (after 2 minutes application of rated voltage at 20°C) 漏電流 ≤0.01CV 或 3µA 取較大值(在 20°C 環境中施加額定工作電壓 2 分鐘後)	Leakage current ≤0.02CV + 15µA (after 5 minutes application of rated voltage at 20°C) 漏電流 ≤0.02CV + 15µA(在 20°C 環境中施加額定工作電壓 5 分鐘後)
Dissipation Factor (tan δ) 損耗角正切	C: Nominal capacitance (µF) 標稱靜電容量, V: Rated voltage (V) 額定電壓	
	When nominal capacitance is over 1000µF, tan δ shall be added 0.02 to the listed value with increase of every 1000µF. 當標稱靜電容量大於 1000µF, 其標稱靜電容量每增加 1000µF, 損耗角正切增加 0.02。 Measurement frequency 測試頻率: 120Hz, Temperature 溫度: 20°C	
	Rated Voltage (V) 額定工作電壓	6.3 10 16 25 35 50 63 100 160~250 350~450
Stability at Low Temperature 低溫特性	Measurement frequency 測試頻率: 120Hz	
	Rated Voltage (V) 額定工作電壓	6.3 10 16 25 35~100 160 200~350 400,450
	Impedance Ratio 阻抗比	Z(-25°C) / Z(20°C) 4 3 2 2 2 4 8 16 Z(-40°C) / Z(20°C) 10 8 6 4 3 8 12 —
Endurance 耐久性	After 2000 hours application of the rated voltage at 85°C, they meet the characteristics listed below. 在 85°C 環境中施加額定工作電壓 2000 小時後, 電容器的特性符合下表的要求。	
	Capacitance Change 靜電容量變化率	Within ±20% of initial measured value 初始值的±20%以內
	Dissipation Factor 損耗角正切	≤200% of initial specified value 不大於規範值的 200%
Shelf Life 高溫貯存特性	After leaving capacitors under no load at 85°C for 1000 hours, they meet the specified value for load life characteristics listed above. 在 85°C 環境中無負荷放置 1000 小時後, 電容器的特性符合高溫負荷特性中所列的規定值。	
	Leakage Current 漏電流	≤initial specified value 不大於規範值
Marking 標識	Printed with white colour on navy blue sleeve (PVC) or printed with white colour on green sleeve (PET). 深藍色膠管白字印刷 (PVC) 或綠色膠管白字印刷 (PET)。	

DRAWING & DIMENSIONS 外形圖及尺寸 (Unit: mm)

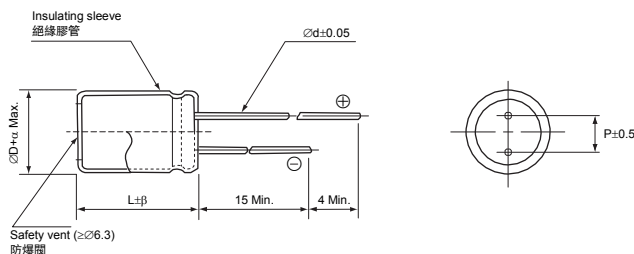

ØD	5	6.3	8 (L≤11.5)	8 (L≥16)	10	13	16	18	22	25
P	2.0	2.5	3.5	5.0	7.5	10.0	12.5			
Ød	0.5		0.6		0.8					
β	1.5			2.0						
α	0.5				1.0					

FREQUENCY COEFFICIENT OF ALLOWABLE RIPPLE CURRENT 紋波電流頻率補償係數

Frequency 頻率	50Hz	120Hz	300Hz	1KHz	10KHz~
Coefficient 係數	0.1 ~ 47µF	0.75	1.0	1.35	2.0
	68 ~ 680µF	0.80	1.0	1.25	1.5
	1000 ~ 22000µF	0.85	1.0	1.10	1.15

The endurance of capacitors is reduced with internal heating produced by ripple current at the rate of halving the lifetime with every 5~10°C rise. When long life performance is required in actual use, the rms ripple current has to be reduced. 鋁電解電容器在疊加紋波電流後會引起發熱, 溫度每上升 5~10°C 壽命會減半。若要保持長壽命性能, 請在使用過程中適當降低紋波電流。

Note: All design and specifications are for reference only and is subject to change without prior notice. If any doubt about safety for your application, please contact us immediately for technical assistance before purchase.
注: 以上所提供的設計及特性參數僅供參考, 任何修改不作預先通知。如果在使用上有疑問, 請在採購前與我們聯繫, 以便提供技術上的協助。

CAT.2023/V2

RA Series

□ DIMENSIONS & MAXIMUM PERMISSIBLE RIPPLE CURRENT 規格尺寸及最大允許紋波電流

WV Code 代碼 μF	6.3		10		16		25		35		50		63		
	0J		1A		1C		1E		1V		1H		1J		
0.1	0R1											5 × 11	6.4	5 × 11	7
0.22	R22											5 × 11	9.5	5 × 11	11
0.33	R33											5 × 11	11	5 × 11	13
0.47	R47											5 × 11	14	5 × 11	15
0.68	R68											5 × 11	17	5 × 11	19
1	010											5 × 11	20	5 × 11	22
2.2	2R2											5 × 11	29	5 × 11	34
3.3	3R3											5 × 11	35	5 × 11	40
4.7	4R7											5 × 11	42	5 × 11	48
6.8	6R8											5 × 11	50	5 × 11	60
10	100					5 × 11	50	5 × 11	65	5 × 11	60	5 × 11	65	5 × 11	70
22	220			5 × 11	50	5 × 11	55	5 × 11	90	5 × 11	95	5 × 11	100	5 × 11	120
33	330			5 × 11	65	5 × 11	85	5 × 11	95	5 × 11	110	5 × 11 (6.3 × 11.5)	125 (136)	6.3 × 11.5	145
47	470			5 × 11	80	5 × 11	90	5 × 11	115	5 × 11	130	6.3 × 11.5	165	6.3 × 11.5	170
68	680			5 × 11	80	5 × 11	104	5 × 11	140	6.3 × 11.5	170	6.3 × 11.5	195	8 × 11.5	245
100	101	5 × 11	134	5 × 11	140	5 × 11	180	5 × 11	190	6.3 × 11.5	210	8 × 11.5	260	8 × 11.5	370
220	221	5 × 11	200	5 × 11	220	6.3 × 11.5	260	6.3 × 11.5	330	8 × 11.5	385	8 × 16 (10 × 12)	425 (482)	10 × 16	490
330	331	6.3 × 11.5	240	6.3 × 11.5	290	6.3 × 11.5 (8 × 11.5)	300 (340)	8 × 11.5	440	10 × 12	490	10 × 16	585	10 × 20	710
470	471	6.3 × 11.5	340	6.3 × 11.5 (8 × 11.5)	350 (410)	8 × 11.5	440	8 × 11.5 (8 × 16)	530 (550)	10 × 16	740	10 × 20	755	13 × 21	900
680	681	8 × 11.5	468	8 × 11.5	470	8 × 16	560	10 × 16	645	10 × 20	930	13 × 21	925	13 × 25	1100
1000	102	8 × 11.5	580	8 × 16 (10 × 12)	550 (650)	8 × 16 (10 × 16)	770 (845)	10 × 16 (10 × 20)	860 (955)	13 × 21	1145	13 × 25	1340	16 × 25 (16 × 31)	1300 (1450)
2200	222	8 × 20 (10 × 16)	660 (845)	10 × 20	1070	10 × 20	1210	13 × 21 (13 × 25)	1300 (1540)	16 × 25	1400	16 × 31 (18 × 35)	1700 (2100)	18 × 35	2040
3300	332	10 × 20	1185	13 × 21	1420	13 × 25	1400	13 × 21 (16 × 25)	1500 (1600)	16 × 31	2070	18 × 35	2500	22 × 40	2575
4700	472	13 × 21	1545	13 × 25	1780	16 × 25	1700	16 × 31	2100	16 × 31 (18 × 35)	2200 (2700)	22 × 40	3040	25 × 40	3200
6800	682	13 × 25	1880	16 × 25	1870	16 × 31	2100	18 × 35	2550	22 × 35	2900	25 × 40	3185		
10000	103	16 × 31	2215	16 × 35	2250	18 × 35	2590	18 × 40 (22 × 40)	2815 (3080)						
15000	153	18 × 31	2250	18 × 35	2820	22 × 40	3100								
22000	223	22 × 35 (22 × 40)	2680 (3140)												

WV Code 代碼 μF	100		160		200		250		350		400		450		
	2A		2C		2D		2E		2V		2G		2W		
0.1	0R1	5 × 11	7.2												
0.22	R22	5 × 11	11												
0.33	R33	5 × 11	13												
0.47	R47	5 × 11	16	5 × 11	12	5 × 11	12	5 × 11	12	6.3 × 11.5	16	6.3 × 11.5	17		
0.68	R68	5 × 11	20	5 × 11	15	5 × 11	15	5 × 11	15	6.3 × 11.5	20	6.3 × 11.5	20		
1	010	5 × 11	25	5 × 11	18	5 × 11	18	6.3 × 11.5	20	6.3 × 11.5	24	6.3 × 11.5	24	8 × 11.5	28
2.2	2R2	5 × 11	33	6.3 × 11.5	25	6.3 × 11.5	33	6.3 × 11.5	33	6.3 × 11.5	37	8 × 11.5	37	8 × 11.5 (10 × 12)	45 (55)
3.3	3R3	5 × 11	40	6.3 × 11.5	35	6.3 × 11.5	46	6.3 × 11.5	46	8 × 11.5	50	8 × 11.5	50	10 × 12	65
4.7	4R7	5 × 11	48	6.3 × 11.5	42	6.3 × 11.5	50	8 × 11.5	55	8 × 11.5	60	10 × 12	80	10 × 16	90
6.8	6R8	5 × 11	55	8 × 11.5	58	8 × 11.5	67	8 × 11.5	77	10 × 12	85	10 × 16	100	10 × 20	125
10	100	5 × 11	65	10 × 12	75	10 × 12	85	10 × 12 (10 × 16)	100 (125)	10 × 16	110	10 × 20	120	13 × 21 (13 × 25)	168 (185)
22	220	6.3 × 11.5	124	10 × 16	130	10 × 16	135	10 × 20	150	13 × 21	190	13 × 21 (13 × 25)	200 (235)	13 × 25	300
33	330	8 × 11.5	177	10 × 16	175	10 × 20	180	13 × 21	215	13 × 25	275	13 × 25	275	16 × 25	320
47	470	10 × 12	235	13 × 21	235	13 × 21	250	13 × 21	290	16 × 25	380	16 × 25	360	16 × 31	390
68	680	10 × 16	293	13 × 21	330	13 × 25	340	16 × 25	380	16 × 31	450	16 × 35	435	16 × 35	460
100	101	10 × 20	405	13 × 25	440	16 × 25	460	16 × 25	510	16 × 35 (18 × 35)	510 (620)	18 × 31 (18 × 35)	520 (586)	18 × 40	580
220	221	13 × 25	640	16 × 31	790	16 × 35 (18 × 31)	830 (850)	18 × 35	890						
330	331	13 × 25	757	18 × 31	970	18 × 35	1150								
470	471	16 × 25	910	18 × 40	1150										
680	681	16 × 31	1365												
1000	102	18 × 40	1820												

•Case size $\varnothing D \times L$ (mm), ripple current (mA rms) at 85°C, 120Hz •尺寸 $\varnothing D \times L$ (mm), 紋波電流(mA rms)於 85°C, 120Hz

- Please refer to page 19 "Taping Specifications" & page 21 "Lead Forming & Cutting" about the taped or formed product spec. 編帶與引線成型標準請查閱第 19 頁 "編帶標準" 及第 21 頁 "引線成型與剪腳"。
- Please refer to page 20 "Packaging Specifications" for the minimum package quantity. 最小包裝數量請查閱第 20 頁 "包裝標準"。
- Please refer to page 16 for the Part Number System. 產品編碼規則請查閱第 16 頁。

Note: All design and specifications are for reference only and is subject to change without prior notice. If any doubt about safety for your application, please contact us immediately for technical assistance before purchase.
注: 以上所提供的設計及特性參數僅供參考, 任何修改不作預先通知。如果在使用上有疑問, 請在採購前與我們聯繫, 以便提供技術上的協助。

CAT.2023/V2

RK Series

WIDE TEMPERATURE

寬溫品

- Wide temperature range of $-40\sim+105^{\circ}\text{C}$
適用於 $-40\sim+105^{\circ}\text{C}$ 的寬溫範圍
- Standard series for general purposes
標準品通用型
- Endurance 2000 hours
耐久性 2000 小時
- Comply with the RoHS & REACH
符合 RoHS 與 REACH

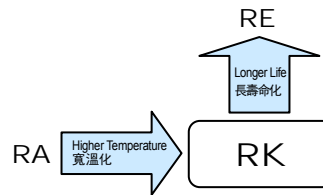
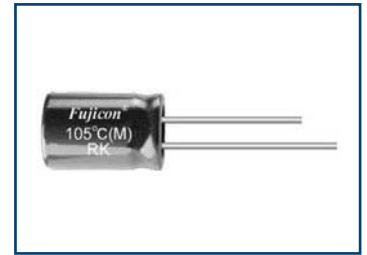

SPECIFICATIONS 特性表

Items 項目	Characteristics 主要特性	
Category Temperature Range 工作溫度範圍	$-40 \sim +105^{\circ}\text{C}$	$-25 \sim +105^{\circ}\text{C}$
Voltage Range 額定工作電壓範圍	6.3 ~ 100V	160 ~ 450V
Capacitance Range 靜電容量範圍	0.47 ~ 15000 μF	0.47 ~ 470 μF
Capacitance Tolerance 靜電容量允許偏差	$\pm 20\%$ at 120Hz, 20°C	
Leakage Current 漏電流	Leakage current $\leq 0.01\text{CV}$ or $3\mu\text{A}$, whichever is greater (after 2 minutes application of rated voltage at 20°C) 漏電流 $\leq 0.01\text{CV}$ 或 $3\mu\text{A}$, 取較大值 (在 20°C 環境中施加額定工作電壓 2 分鐘後)	Leakage current $\leq 0.02\text{CV} + 15\mu\text{A}$ (after 5 minutes application of rated voltage at 20°C) 漏電流 $\leq 0.02\text{CV} + 15\mu\text{A}$ (在 20°C 環境中施加額定工作電壓 5 分鐘後)
Dissipation Factor ($\tan \delta$) 損耗角正切	C: Nominal capacitance (μF) 標稱靜電容量, V: Rated voltage (V) 額定電壓	
	When nominal capacitance is over $1000\mu\text{F}$, $\tan \delta$ shall be added 0.02 to the listed value with increase of every $1000\mu\text{F}$. 當標稱靜電容量大於 $1000\mu\text{F}$, 其標稱靜電容量每增加 $1000\mu\text{F}$, 損耗角正切增加 0.02. Measurement frequency 測試頻率: 120Hz, Temperature 溫度: 20°C	
Stability at Low Temperature 低溫特性	Measurement frequency 測試頻率: 120Hz	
	Rated Voltage (V) 額定工作電壓	6.3 10 16 25 35 50 63 100 160~250 350~450
Endurance 耐久性	Impedance Ratio $Z(-25^{\circ}\text{C}) / Z(20^{\circ}\text{C})$ 阻抗比	4 3 2 2 3 4 3 4 —
	Impedance Ratio $Z(-40^{\circ}\text{C}) / Z(20^{\circ}\text{C})$ 阻抗比	8 6 4 3 4 —
Shelf Life 高溫貯存特性	After 2000 hours application of the rated voltage at 105°C , they meet the characteristics listed below. 在 105°C 環境中施加額定工作電壓 2000 小時後, 電容器的特性符合下表的要求。	
	Capacitance Change 靜電容量變化率	Within $\pm 20\%$ of initial measured value 初始值的 $\pm 20\%$ 以內
Marking 標識	Dissipation Factor 損耗角正切	$\leq 200\%$ of initial specified value 不大於規範值的 200%
	Leakage Current 漏電流	\leq initial specified value 不大於規範值
Marking 標識	After leaving capacitors under no load at 105°C for 1000 hours, they meet the specified value for load life characteristics listed above. 在 105°C 環境中無負荷放置 1000 小時後, 電容器的特性符合高溫負荷特性中所列的規定值。	
	Printed with white colour on black sleeve (PVC) or printed with white colour on green sleeve (PET). 黑色膠管白字印刷 (PVC) 或綠色膠管白字印刷 (PET).	

DRAWING & DIMENSIONS 外形圖及尺寸 (Unit: mm)

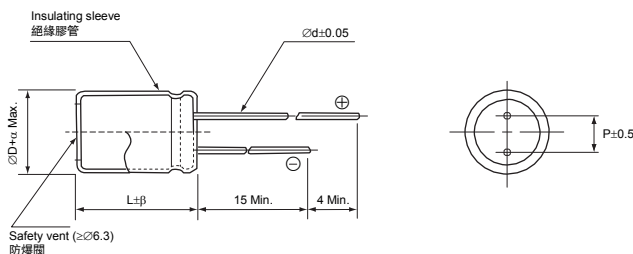

$\varnothing D$	5	6.3	8 (L ≤ 11.5)	8 (L ≤ 16)	10	13	16	18	22	25
P	2.0	2.5	3.5		5.0	7.5		10.0	12.5	
$\varnothing d$	0.5			0.6			0.8			
β	1.5					2.0				
α	0.5						1.0			

FREQUENCY COEFFICIENT OF ALLOWABLE RIPPLE CURRENT 紋波電流頻率補償系數

Frequency 頻率	50Hz	120Hz	300Hz	1KHz	10KHz~
Coefficient 系數	0.75	1.00	1.35	1.55	2.00
	0.80	1.00	1.25	1.34	1.50
	0.85	1.00	1.10	1.13	1.15

The endurance of capacitors is reduced with internal heating produced by ripple current at the rate of halving the lifetime with every $5\sim 10^{\circ}\text{C}$ rise. When long life performance is required in actual use, the rms ripple current has to be reduced. 鋁電解電容器在疊加紋波電流後會引起發熱, 溫度每上升 $5\sim 10^{\circ}\text{C}$ 壽命會減半。若要保持長壽命性能, 請在使用過程中適當降低紋波電流。

Note: All design and specifications are for reference only and is subject to change without prior notice. If any doubt about safety for your application, please contact us immediately for technical assistance before purchase.
注: 以上所提供的設計及特性參數僅供參考, 任何修改不作預先通知。如果在使用上有疑問, 請在採購前與我們聯繫, 以便提供技術上的協助。

CAT.2023/V2

RK Series

□ DIMENSIONS & MAXIMUM PERMISSIBLE RIPPLE CURRENT 規格尺寸及最大允許紋波電流

WV Code 代碼	6.3		10		16		25		35		50		63		
	μF	0J	1A	1C	1E	1V	1H	1J							
0.47	R47											5 x 11	8	5 x 11	8
0.68	R68											5 x 11	9	5 x 11	9
1	010											5 x 11	11	5 x 11	13
2.2	2R2											5 x 11	20	5 x 11	15
3.3	3R3											5 x 11	30	5 x 11	19
4.7	4R7											5 x 11	33	5 x 11	22
6.8	6R8											5 x 11	42	5 x 11	34
10	100				5 x 11	50	5 x 11	38	5 x 11	41	5 x 11	50	5 x 11	50	50
22	220			5 x 11	50	5 x 11	54	5 x 11	57	5 x 11	61	5 x 11 (6.3 x 11.5)	78 (85)	6.3 x 11.5	86
33	330			5 x 11	60	5 x 11	64	5 x 11	69	5 x 11	75	6.3 x 11.5	95	6.3 x 11.5	100
47	470	5 x 11	62	5 x 11	71	5 x 11	80	5 x 11	106	5 x 11 (6.3 x 11.5)	106 (110)	6.3 x 11.5	125	6.3 x 11.5 (8 x 11.5)	130 (150)
68	680	5 x 11	80	5 x 11	83	5 x 11	85	5 x 11	114	6.3 x 11.5	121	8 x 11.5	144	8 x 11.5	128
100	101	5 x 11	95	5 x 11	100	5 x 11 (6.3 x 11.5)	120 (135)	5 x 11 (6.3 x 11.5)	120 (145)	6.3 x 11.5 (8 x 11.5)	150 (180)	8 x 11.5 (10 x 12)	188 (200)	8 x 11.5 (10 x 12)	200 (295)
220	221	5 x 11	150	5 x 11 (6.3 x 11.5)	155 (175)	6.3 x 11.5 (8 x 11.5)	190 (230)	6.3 x 11.5 (8 x 11.5)	190 (236)	8 x 11.5	270	10 x 12 (10 x 16)	345 (370)	10 x 12 (10 x 16)	390 (440)
330	331	6.3 x 11.5	170	6.3 x 11.5	200	8 x 11.5	270	8 x 11.5 (10 x 12)	310 (335)	10 x 12 (8 x 16)	395 (455)	10 x 16 (10 x 20)	420 (460)	10 x 20 (13 x 21)	510 (560)
470	471	6.3 x 11.5	230	6.3 x 11.5 (8 x 11.5) (10 x 12)	260 (290) (320)	8 x 11.5	310	8 x 11.5 (8 x 16) (10 x 12)	325 (350) (380)	10 x 16 (10 x 20)	520 (550)	10 x 20 (13 x 21)	560 (630)	13 x 21 (13 x 25)	650 (700)
680	681	8 x 11.5	314	8 x 11.5 (8 x 16)	345 (390)	8 x 16 (10 x 16)	480 (520)	10 x 16	520	10 x 16 (10 x 20)	550 (590)	13 x 25 (16 x 25)	720	13 x 25 (16 x 25)	780 (800)
1000	102	8 x 11.5	380	8 x 11.5 (8 x 16) (10 x 12)	400 (425) (585)	8 x 20 (10 x 16) (10 x 20)	580 (645) (700)	10 x 16 (10 x 20) (13 x 21)	705 (775) (845)	13 x 21 (13 x 25)	810 (930)	13 x 25 (16 x 25)	950 (1080)	16 x 25	930
2200	222	10 x 12 (10 x 16)	630 (690)	10 x 20 (13 x 21)	760 (815)	10 x 20 (13 x 21)	735 (760)	13 x 21 (13 x 25)	890 (1110)	13 x 25 (16 x 25)	1080 (1260)	16 x 35 (18 x 35)	1470 (1530)	16 x 31 (18 x 35)	1565 (2180)
3300	332	10 x 20 (13 x 21)	845 (920)	13 x 25	1130	13 x 25 (13 x 25)	980 (1170)	16 x 25	1440	16 x 31 (16 x 35)	1420 (1480)	18 x 35	1770	22 x 40	2510
4700	472	13 x 21 (13 x 25)	1200 (1240)	13 x 25	1280	16 x 25	1320	16 x 31	1650	16 x 35 (18 x 35)	1720 (1900)	18 x 40 (22 x 40)	2055 (2340)	25 x 40	3000
6800	682	16 x 25	1480	16 x 31	1510	16 x 25 (16 x 31)	1620 (1930)	18 x 35	2160	22 x 40	2216	25 x 40	2530		
10000	103	16 x 31	1920	16 x 31 (16 x 35)	2100 (2220)	18 x 35 (22 x 30)	2350 (2450)	18 x 40	2500						
15000	153	18 x 31	2390												

WV Code 代碼	100		160		200		250		350		400		450		
	μF	2A	2C	2D	2E	2V	2G	2W							
0.47	R47	5 x 11	14	5 x 11	12	5 x 11	12	5 x 11	12	6.3 x 11.5	12	6.3 x 11.5	12	6.3 x 11.5	12
0.68	R68	5 x 11	15	5 x 11	13	5 x 11	13	5 x 11	13	6.3 x 11.5	13	6.3 x 11.5	13	8 x 11.5	13
1	010	5 x 11	19	5 x 11	16	5 x 11	16	6.3 x 11.5	16	6.3 x 11.5	16	6.3 x 11.5 (8 x 11.5)	21 (25)	8 x 11.5	27
2.2	2R2	5 x 11	30	6.3 x 11.5	23	6.3 x 11.5	30	6.3 x 11.5	35	8 x 11.5	38	6.3 x 11.5 (8 x 11.5)	32 (39)	8 x 11.5	39
3.3	3R3	5 x 11	32	6.3 x 11.5	34	6.3 x 11.5	39	8 x 11.5	42	8 x 11.5	43	6.3 x 11.5 (8 x 11.5)	40 (45)	8 x 11.5	45
4.7	4R7	5 x 11	38	6.3 x 11.5	40	8 x 11.5	46	8 x 11.5	45	10 x 12	55	8 x 11.5 (10 x 12)	50 (55)	8 x 11.5 (10 x 12)	50 (55)
6.8	6R8	5 x 11	52	8 x 11.5	48	8 x 11.5	52	8 x 11.5 (10 x 12)	52 (57)	10 x 16	62	8 x 16 (10 x 16)	65 (80)	10 x 16	90
10	100	5 x 11 (6.3 x 11.5)	66 (73)	8 x 11.5 (10 x 12)	65 (60)	8 x 11.5 (10 x 12)	65 (70)	10 x 12 (10 x 16)	92 (116)	10 x 16	95	10 x 16 (10 x 20)	95 (105)	13 x 21	125
22	220	6.3 x 11.5 (8 x 11.5)	104 (120)	10 x 16	96	10 x 16	140	10 x 16 (10 x 20)	140 (145)	13 x 21	220	13 x 21 (13 x 25) (16 x 20)	160 (170) (185)	13 x 25	185
33	330	8 x 11.5	150	10 x 20	155	10 x 16 (10 x 20)	155 (170)	13 x 21	190	13 x 25	215	13 x 25 (16 x 25)	185 (245)	16 x 20 (16 x 25)	207 (260)
47	470	10 x 12	190	13 x 21	220	13 x 21	220	13 x 21 (13 x 25)	210 (250)	16 x 25	285	16 x 25 (16 x 31)	295 (320)	16 x 25 (16 x 31)	305 (313)
68	680	10 x 16	239	13 x 21	275	13 x 21 (13 x 25)	240 (270)	16 x 25	365	16 x 31	370	16 x 31 (16 x 35)	350 (405)	16 x 35 (18 x 31)	435 (450)
100	101	10 x 20	320	13 x 25	355	16 x 25 (16 x 31)	385 (465)	16 x 31	485	16 x 31 (18 x 35)	395 (485)	18 x 31 (18 x 35)	420 (540)	18 x 35 (18 x 40)	520 (560)
150	151	13 x 21	380	16 x 25	460	16 x 25	465	18 x 25	530	18 x 35	570	18 x 40	600		
220	221	13 x 25	450	16 x 31	660	16 x 35 (18 x 31)	695 (755)	18 x 35	760			22 x 40	650		
330	331	13 x 25	625	18 x 35	820	18 x 35 (18 x 40)	820 (965)								
470	471	16 x 25	780	18 x 40	975	22 x 40	1050								
680	681	16 x 35	1021												
1000	102	18 x 40	1344											Case size 尺寸	Ripple current 紋波電流

•Case size ØD×L(mm), ripple current (mA rms) at 105°C, 120Hz •尺寸ØD×L(mm), 紋波電流(mA rms)於 105°C, 120Hz

- Please refer to page 19 "Taping Specifications" & page 21 "Lead Forming & Cutting" about the taped or formed product spec. 編帶與引線成型標準請查閱第 19 頁 "編帶標準" 及第 21 頁 "引線成型與剪腳"。
- Please refer to page 20 "Packaging Specifications" for the minimum package quantity. 最小包裝數量請查閱第 20 頁 "包裝標準"。
- Please refer to page 16 for the Part Number System. 產品編碼規則請查閱第 16 頁。

Note: All design and specifications are for reference only and is subject to change without prior notice. If any doubt about safety for your application, please contact us immediately for technical assistance before purchase.
 注: 以上所提供的設計及特性參數僅供參考, 任何修改不作預先通知。如果在使用上有疑問, 請在採購前與我們聯繫, 以便提供技術上的協助。

CAT.2023/V2

KT Series New
新品

SLEEVELESS, WIDE TEMPERATURE

無膠管，寬溫品

- Operating with wide temperature range -55~+105°C
適用於 -55~+105°C 的寬溫範圍
- Endurance 2000 hours
耐久性 2000 小時
- Sleeveless
無膠管
- RoHS & REACH compliant, Halogen-free
符合 RoHS 與 REACH，無鹵

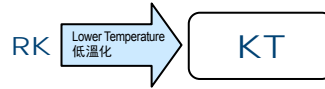

□ SPECIFICATIONS 特性表

Items 項目	Characteristics 主要特性												
Category Temperature Range 工作溫度範圍	-55 ~ +105°C	-40 ~ +105°C	-25 ~ +105°C										
Voltage Range 額定工作電壓範圍	4 ~ 100V	160 ~ 400V	450V										
Capacitance Range 靜電容量範圍	0.1 ~ 8200μF	3.3 ~ 100μF	3.3 ~ 33μF										
Capacitance Tolerance 靜電容量允許偏差	±20% at 120Hz, 20°C												
Leakage Current 漏電流	Rated Voltage 額定工作電壓	6.3 ~ 100V											
	Case size 尺寸	Ø4~Ø10	Ø12.5~Ø18										
	Time 時間	After 2 min. application of rated voltage at 20°C 在 20°C 環境中施加額定工作電壓 2 分鐘後	After 1 min. application of rated voltage at 20°C 在 20°C 環境中施加額定工作電壓 1 分鐘後										
	Leakage current 漏電流	≤0.01CV or 3μA, whichever is greater ≤0.01CV 或 3μA, 取較大值	≤0.03CV or 4μA, whichever is greater ≤0.03CV 或 4μA, 取較大值										
Dissipation Factor (tan δ) 損耗角正切	Measurement frequency 測試頻率: 120Hz, Temperature 溫度: 20°C												
	Rated Voltage (V) 額定工作電壓	4	6.3	10	16	25	35	50	63	100	160~250	350~450	
Stability at Low Temperature 低溫特性	Measurement frequency 測試頻率: 120Hz												
	Rated Voltage (V) 額定工作電壓												
	Impedance Ratio 阻抗比	Ø4~Ø10	Z(-25°C)/Z(20°C)	7	4	3	2	2	2	2	3	2	3
			Z(-55°C)/Z(20°C)	15	8	6	4	4	3	3	4	3	6
ZT/Z20 (max.)	Ø12.5~Ø18	Z(-25°C)/Z(20°C)	7	5	4	3	2	2	2	2	2	4	
		Z(-55°C)/Z(20°C)	17	12	10	8	5	4	3	3	6	10	
Endurance 耐久性	After 2000 hours application of the rated voltage at 105°C, they meet the characteristics listed below. 在 105°C 環境中施加額定工作電壓 2000 小時後，電容器的特性符合下表的要求。												
	Capacitance Change 靜電容量變化率	Within ±20% of initial value for capacitors of 10V or more (Within ±30% of initial value for capacitors of 4V or less) ≥10V 為初始值的±20%以內 (≤4V 為初始值的±30%以內)											
	Dissipation Factor 損耗角正切	200% or less of initial specified value 不大於規範值的 200%											
	Leakage Current 漏電流	initial specified value or less 不大於規範值											
Shelf Life 高溫貯存特性	After leaving capacitors under no load at 105°C for 1000 hours, they meet the specified value for load life characteristics listed above. 在 105°C 環境中無負荷放置 1000 小時後，電容器的特性符合高溫負荷特性中所列的規定值。												
Marking 標識	Black print on the case top. 鋁殼頂部黑字印刷。												

□ DRAWING 外形圖 (Unit: mm)

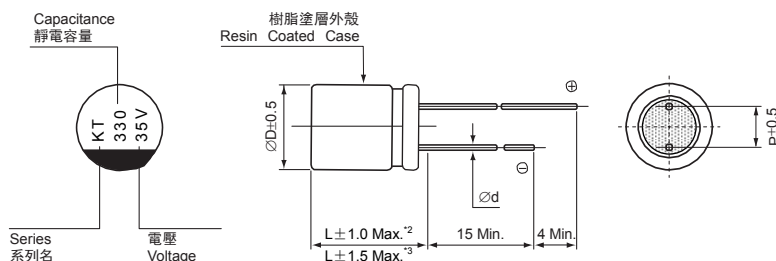

- *1. Voltage mark for 6.3V is [6V]
*2. Applicable to Ø4~Ø8
*3. Applicable to Ø10 and above
- 6.3V 的產品標識為 [6V]
適用於 Ø4~Ø8
適用於 Ø10 和 Ø10 以上

Dimension table in next page.
尺寸表見下一頁。

Note: All design and specifications are for reference only and is subject to change without prior notice. If any doubt about safety for your application, please contact us immediately for technical assistance before purchase.

注：以上所提供的設計及特性參數僅供參考，任何修改不作預先通知。如果在使用上有疑問，請在採購前與我們聯繫，以便提供技術上的協助。

CAT.2023/V2

KT Series New
新品

□ DIMENSIONS (Unit: mm) 尺寸表

∅D x L	4 x 5	5 x 5	6.3 x 5/7	8 x 5/10	10 x 10/13	12.5 x 13/16	16 x 16	18 x 16/18
P	1.5	2.0	2.5	3.5	5.0	5.0	7.5	7.5
∅d	0.45	0.45	0.45	0.5	0.6	0.6	0.8	0.8
L	5.0	5.0	5.0/7.0	5.0/10.0	10.0/13.0	13.0/16.0	16.0	16.0/18.0

□ DIMENSIONS & MAXIMUM PERMISSIBLE RIPPLE CURRENT 規格尺寸及最大允許紋波電流

WV		4		6.3		10		16		25	
μF	Code 代碼	0G		0J		1A		1C		1E	
		4.7	4R7							4 x 5	13
10	100							4 x 5	20	5 x 5 (4 x 5)	23 (20)
22	220	4 x 5	20	4 x 5	23	5 x 5 (4 x 5)	29 (22)	5 x 5 (4 x 5)	32 (25)	6.3 x 5 (5 x 5)	39 (32)
33	330	5 x 5 (4 x 5)	30 (25)	5 x 5 (4 x 5)	34 (30)	5 x 5 (4 x 5)	35 (30)	6.3 x 5 (5 x 5)	45 (35)	6.3 x 5 (5 x 5)	48 (35)
47	470	5 x 5 (4 x 5)	36 (30)	5 x 5 (4 x 5)	38 (35)	5 x 5	38	6.3 x 5 (5 x 5)	55 (40)	6.3 x 5	60
100	101	6.3 x 5 (5 x 5)	64 (54)	6.3 x 5 (5 x 5)	69 (59)	6.3 x 5 (5 x 5)	80 (60)	6.3 x 5	80	6.3 x 7 (6.3 x 5) (8 x 5)	100 (80) (130)
150	151	6.3 x 5	80	6.3 x 5	85	6.3 x 5	85	6.3 x 7	105	8 x 10 (6.3 x 7)	240 (120)
220	221	6.3 x 5	90	6.3 x 7 (6.3 x 5)	120 (95)	6.3 x 7 (6.3 x 5)	120 (95)	8 x 10 (6.3 x 7)	270 (120)	8 x 10	270
330	331	6.3 x 7	120	6.3 x 7	120	8 x 10 (6.3 x 7)	290 (135)	8 x 10	290	10 x 10 (8 x 10)	380 (290)
470	471	6.3 x 7	120	8 x 10 (6.3 x 7)	320 (120)	10 x 10 (8 x 10)	380 (320)	10 x 10 (8 x 10)	380 (290)	10 x 10	380
680	681	8 x 10	320	8 x 10	350	10 x 10 (8 x 10)	380 (350)	10 x 10	380	10 x 13	400
1000	102	8 x 10	320	10 x 10 (8 x 10)	410 (350)	10 x 10	410	12.5 x 13 (10 x 13) (10 x 10)	550 (460) (410)	12.5 x 13	580
1500	152	10 x 10	410	10 x 13 (10 x 10)	450 (410)	10 x 13	460	12.5 x 13	550	12.5 x 16	850
2200	222	10 x 13 (10 x 10)	440 (410)	12.5 x 13 (10 x 13)	680 (560)	12.5 x 13	680	16 x 16 (12.5 x 16)	900 (750)	16 x 16	1050
3300	332	10 x 13	490	12.5 x 16 (12.5 x 13)	850 (810)	16 x 16	1000	16 x 16	1000	18 x 16	1150
4700	472	12.5 x 13	600	16 x 16	1000	16 x 16	1000	18 x 16	1225	18 x 18	1300
6800	682	16 x 16 (12.5 x 16)	950 (650)	18 x 16	1290	18 x 16	1290			Case size 尺寸	Ripple current 紋波電流
8200	822			18 x 18	1450	18 x 18	1450				

WV		35		50		63		100	
μF	Code 代碼	1V		1H		1J		2A	
		0.1	0R1			4 x 5	2	4 x 5	2
0.22	R22			4 x 5	4	4 x 5	4		
0.33	R33			4 x 5	4	4 x 5	4		
0.47	R47			4 x 5	5	4 x 5	5		
1	010			4 x 5	8	4 x 5	8	4 x 5	8
2.2	2R2			4 x 5	12	4 x 5	12	6.3 x 5 (5 x 5)	14 (12)
3.3	3R3	4 x 5	13	4 x 5	14	5 x 5	17	6.3 x 7 (6.3 x 5)	55 (20)
4.7	4R7	4 x 5	17	5 x 5 (4 x 5)	20 (14)	5 x 5	20	6.3 x 7 (6.3 x 5)	50 (21)
10	100	5 x 5 (4 x 5)	27 (18)	6.3 x 5 (5 x 5)	32 (27)	6.3 x 7 (6.3 x 5)	58 (32)	8 x 10 (8 x 5) (6.3 x 7)	77 (55) (58)
22	220	6.3 x 5 (5 x 5)	44 (36)	6.3 x 7 (6.3 x 5)	58 (44)	8 x 10 (6.3 x 7)	100 (58)	10 x 10 (8 x 10)	126 (100)
33	330	6.3 x 5	50	6.3 x 7	65	8 x 10	140	10 x 10	150
47	470	6.3 x 7 (6.3 x 5)	80 (58)	8 x 10 (6.3 x 7)	170 (70)	10 x 10 (8 x 10)	160 (170)	12.5 x 13 (10 x 13) (10 x 10)	250 (180) (160)
68	680					Case size 尺寸	Ripple current 紋波電流	12.5 x 13 (10 x 13)	300 (180)

•Case size ∅D×L(mm), ripple current (mA rms) at 105°C, 120Hz •尺寸∅D×L(mm), 紋波電流(mA rms)於 105°C, 120Hz

Note: All design and specifications are for reference only and is subject to change without prior notice. If any doubt about safety for your application, please contact us immediately for technical assistance before purchase.

注：以上所提供的設計及特性參數僅供參考，任何修改不作預先通知。如果在使用上有疑問，請在採購前與我們聯繫，以便提供技術上的協助。

CAT.2023/V2

KT Series New
新品

□ DIMENSIONS & MAXIMUM PERMISSIBLE RIPPLE CURRENT 規格尺寸及最大允許紋波電流

WV Code 代碼	μF	35		50		63		100		160	
		1V		1H		1J		2A		2C	
22	220									10 × 13	50
33	330									12.5 × 13	95
47	470							10 × 10	160	12.5 × 13 (16 × 16)	205 (240)
100	101	8 × 10 (6.3 × 7)	240 (92)	10 × 10 (8 × 10)	250 (210)	12.5 × 13 (10 × 13) (10 × 10)	400 (350) (310)	16 × 16 (12.5 × 13)	450 (380)	16 × 16	250
150	151	8 × 10	240	10 × 10	300	10 × 13	350				
220	221	10 × 10 (8 × 10)	270 (250)	10 × 13 (10 × 10)	330 (280)	16 × 16 (12.5 × 13)	560 (470)	16 × 16	550		
330	331	10 × 10	370	16 × 16 (12.5 × 13) (10 × 13)	600 (490) (295)	16 × 16 (12.5 × 16)	700 (510)	18 × 16	590		
470	471	12.5 × 13 (10 × 13) (10 × 10)	520 (400) (370)	16 × 16 (12.5 × 16) (12.5 × 13)	700 (550) (470)	16 × 16	750	18 × 18	980		
680	681	12.5 × 13	530	16 × 16	750	18 × 16	790				
1000	102	16 × 16 (12.5 × 16)	800 (600)	18 × 16	990						
1500	152	16 × 16	750							Case size 尺寸	Ripple current 紋波電流
2200	222	18 × 16	1050								

WV Code 代碼	μF	200		250		350		400		450	
		2D		2E		2V		2G		2W	
3.3	3R3							10 × 13 (8 × 10)	40 (35)	10 × 13 (8 × 12)	40 (38)
4.7	4R7			10 × 13	65	10 × 13	45	10 × 13 (12.5 × 13)	45 (48)	10 × 13 (12.5 × 13)	42 45
10	100	10 × 13	75	10 × 13	70	12.5 × 13	50	12.5 × 13	50	12.5 × 13	70
22	220	12.5 × 13	105	12.5 × 13	105	16 × 16	85	16 × 16	85	16 × 16	85
33	330	12.5 × 13	120	16 × 16	180	18 × 16	100	18 × 16	100	18 × 16	100
47	470	16 × 16	220	16 × 16	220						
100	101	18 × 16	280	18 × 16	260					Case size 尺寸	Ripple current 紋波電流

•Case size $\varnothing D \times L$ (mm), ripple current (mA rms) at 105°C, 120Hz •尺寸 $\varnothing D \times L$ (mm), 紋波電流(mA rms)於 105°C, 120Hz

□ FREQUENCY COEFFICIENT OF ALLOWABLE RIPPLE CURRENT 紋波電流頻率補償系數

Frequency 頻率		50Hz	120Hz	300Hz	1KHz	10KHz~
Coefficient 系數	Ø4 ~ Ø10	0.1 ~ 68μF	0.70	1.00	1.17	1.36
		100 ~ 3300μF	0.85	1.00	1.08	1.20
	Ø12.5 ~ Ø18	~ 68μF	0.75	1.00	1.35	1.57
		100 ~ 680μF	0.80	1.00	1.23	1.34
		1000 ~ 6800μF	0.85	1.00	1.10	1.13

The endurance of capacitors is reduced with internal heating produced by ripple current at the rate of halving the lifetime with every 5~10°C rise. When long life performance is required in actual use, the rms ripple current has to be reduced. 鋁電解電容器在疊加紋波電流後會引起發熱，溫度每上升 5~10°C 壽命會減半。若要保持長壽命性能，請在使用過程中適當降低紋波電流。

- Taping specifications are given in page 17. 編帶標準請查閱第 17 頁。
- Soldering conditions and recommended land size are given in page 23. 焊接條件及推薦安裝尺寸請查閱第 23 頁。
- Please refer to page 18 for the minimum package quantity. 最小包裝數量請查閱第 18 頁。
- Please refer to page 15 for the Part Number System. 產品編碼規則請查閱第 15 頁。

Note: All design and specifications are for reference only and is subject to change without prior notice. If any doubt about safety for your application, please contact us immediately for technical assistance before purchase.

注：以上所提供的設計及特性參數僅供參考，任何修改不作預先通知。如果在使用上有疑問，請在採購前與我們聯繫，以便提供技術上的協助。

CAT.2023/V2

RE Series

WIDE TEMPERATURE

寬溫品

- Wide temperature range of -40~+105°C
適用於 -40~+105°C 的寬溫範圍
- Standard series for general purposes
標準品通用型
- Endurance 3000 hours
耐久性 3000 小時
- Comply with the RoHS & REACH
符合 RoHS 與 REACH

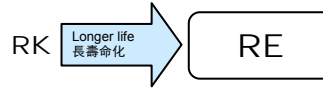
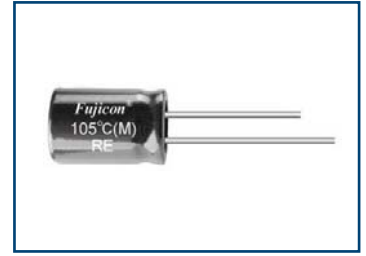

SPECIFICATIONS 特性表

Items 項目	Characteristics 主要特性	
Category Temperature Range 工作溫度範圍	-40 ~ +105°C	-25 ~ +105°C
Voltage Range 額定工作電壓範圍	6.3 ~ 100V	160 ~ 450V
Capacitance Range 靜電容量範圍	0.47 ~ 15000µF	1 ~ 470µF
Capacitance Tolerance 靜電容量允許偏差	±20% at 120Hz, 20°C	
Leakage Current 漏電流	Leakage current ≤0.01CV or 3µA, whichever is greater (after 2 minutes application of rated voltage at 20°C) 漏電流 ≤0.01CV 或 3µA 取較大值(在 20°C 環境中施加額定工作電壓 2 分鐘後)	Leakage current ≤0.02CV + 15µA (after 5 minutes application of rated voltage at 20°C) 漏電流 ≤0.02CV + 15µA(在 20°C 環境中施加額定工作電壓 5 分鐘後)
Dissipation Factor (tan δ) 損耗角正切	C: Nominal capacitance (µF) 標稱靜電容量, V: Rated voltage (V) 額定電壓	
	When nominal capacitance is over 1000µF, tan δ shall be added 0.02 to the listed value with increase of every 1000µF. 當標稱靜電容量大於 1000µF, 其標稱靜電容量每增加 1000µF, 損耗角正切增加 0.02. Measurement frequency 測試頻率: 120Hz, Temperature 溫度: 20°C	
Stability at Low Temperature 低溫特性	Measurement frequency 測試頻率: 120Hz	
	Rated Voltage (V) 額定工作電壓	6.3 10 16 25 35 50 63 100 160~250 350~450
Endurance 耐久性	After 3000 hours application of the rated voltage at 105°C, they meet the characteristics listed below. 在 105°C 環境中施加額定工作電壓 3000 小時後, 電容器的特性符合下表的要求。	
	Capacitance Change 靜電容量變化率	Within ±20% of initial measured value 初始值的±20%以內
Shelf Life 高溫貯存特性	After leaving capacitors under no load at 105°C for 1000 hours, they meet the specified value for load life characteristics listed above. 在 105°C 環境中無負荷放置 1000 小時後, 電容器的特性符合高溫負荷特性中所列的規定值。	
	Dissipation Factor 損耗角正切	≤200% of initial specified value 不大於規範值的 200%
Marking 標識	Printed with white colour on black sleeve (PVC) or printed with white colour on green sleeve (PET). 黑色膠管白字印刷 (PVC) 或綠色膠管白字印刷 (PET)。	
	Leakage Current 漏電流	≤initial specified value 不大於規範值

DRAWING & DIMENSIONS 外形圖及尺寸 (Unit: mm)

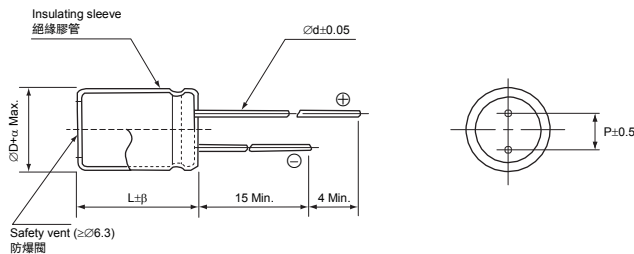

ØD	5	6.3	8 (L≤11.5)	8 (L≥16)	10	13	16	18	22	25
P	2.0	2.5	3.5		5.0	7.5		10.0	12.5	
Ød	0.5			0.6			0.8			
β	1.5					2.0				
α	0.5								1.0	

FREQUENCY COEFFICIENT OF ALLOWABLE RIPPLE CURRENT 紋波電流頻率補償系數

Frequency 頻率	50Hz	120Hz	300Hz	1KHz	10KHz~
Coefficient 系數	0.75	1.00	1.35	1.55	2.00
	0.80	1.00	1.25	1.34	1.50
	0.85	1.00	1.10	1.13	1.15

The endurance of capacitors is reduced with internal heating produced by ripple current at the rate of halving the lifetime with every 5~10°C rise. When long life performance is required in actual use, the rms ripple current has to be reduced. 鋁電解電容器在疊加紋波電流後會引起發熱, 溫度每上升 5~10°C 壽命會減半。若要保持長壽命性能, 請在使用過程中適當降低紋波電流。

Note: All design and specifications are for reference only and is subject to change without prior notice. If any doubt about safety for your application, please contact us immediately for technical assistance before purchase.

注: 以上所提供的設計及特性參數僅供參考, 任何修改不作預先通知。如果在使用上有疑問, 請在採購前與我們聯繫, 以便提供技術上的協助。

CAT.2023/V2

RE Series

□ DIMENSIONS & MAXIMUM PERMISSIBLE RIPPLE CURRENT 規格尺寸及最大允許紋波電流

μF	WV Code 代碼	6.3		10		16		25		35		50		63	
		0J		1A		1C		1E		1V		1H		1J	
0.47	R47											5 x 11	8	5 x 11	8
0.68	R68											5 x 11	9	5 x 11	9
1	010											5 x 11	11	5 x 11	13
2.2	2R2											5 x 11	20	5 x 11	15
3.3	3R3											5 x 11	30	5 x 11	19
4.7	4R7											5 x 11	33	5 x 11	22
6.8	6R8											5 x 11	42	5 x 11	34
10	100					5 x 11	50	5 x 11	38	5 x 11	41	5 x 11	50	5 x 11	50
22	220			5 x 11	50	5 x 11	54	5 x 11	57	5 x 11	61	5 x 11 (6.3 x 11.5)	78 (85)	6.3 x 11.5	86
33	330			5 x 11	60	5 x 11	64	5 x 11	69	5 x 11	75	6.3 x 11.5	95	6.3 x 11.5	100
47	470	5 x 11	62	5 x 11	71	5 x 11	80	5 x 11	106	5 x 11 (6.3 x 11.5)	106 (110)	6.3 x 11.5	125	6.3 x 11.5	130
68	680	5 x 11	80	5 x 11	83	5 x 11	85	5 x 11	114	6.3 x 11.5	121	8 x 11.5	144	8 x 11.5	128
100	101	5 x 11	95	5 x 11	100	5 x 11 (6.3 x 11.5)	120 (135)	5 x 11 (6.3 x 11.5)	120 (145)	6.3 x 11.5 (8 x 11.5)	150 (180)	8 x 11.5 (10 x 12)	188 (200)	10 x 12	295
220	221	5 x 11	150	5 x 11 (6.3 x 11.5)	155 (175)	6.3 x 11.5	190	6.3 x 11.5 (8 x 11.5)	190 (236)	8 x 11.5	270	10 x 12 (10 x 16)	345 (370)	10 x 16	390
330	331	6.3 x 11.5	170	6.3 x 11.5	200	8 x 11.5	270	8 x 11.5 (10 x 12)	310 (335)	10 x 12 (8 x 16)	395 (455)	10 x 16 (10 x 20)	420 (460)	10 x 20 (13 x 21)	510 (560)
470	471	6.3 x 11.5	230	6.3 x 11.5 (8 x 11.5)	260 (290)	8 x 11.5	310	8 x 11.5 (8 x 16) (10 x 12)	325 (350) (380)	10 x 16 (10 x 20)	520 (550)	13 x 21	560	13 x 21 (13 x 25)	650 (700)
680	681	8 x 11.5	314	8 x 11.5 (8 x 16)	345 (390)	8 x 16 (10 x 16)	480 (520)	10 x 16	520	10 x 16 (10 x 20)	550 (590)	13 x 25	720	16 x 25	800
1000	102	8 x 11.5	380	8 x 11.5 (8 x 16) (10 x 12)	400 (425) (585)	8 x 20 (10 x 16) (10 x 20)	580 (645) (700)	10 x 20 (13 x 21)	775 (845)	13 x 21 (13 x 25)	810 (930)	16 x 25	1080	16 x 25	930
2200	222	10 x 12 (10 x 16)	630 (690)	10 x 20 (13 x 21)	760 (815)	13 x 21	760	13 x 21 (13 x 25)	890 (1110)	13 x 25 (16 x 25)	1080 (1260)	16 x 35 (18 x 35)	1470 (1530)	16 x 31 (18 x 35)	1565 (2180)
3300	332	10 x 20 (13 x 21)	845 (920)	13 x 25	1130	13 x 21 (13 x 25)	980 (1170)	16 x 25	1440	16 x 31 (16 x 35)	1420 (1480)	18 x 35	1770		
4700	472	13 x 25	1240	13 x 25	1280	16 x 25	1320	16 x 31	1650	18 x 35	1900	22 x 40	2340		
6800	682	16 x 25	1480	16 x 31	1510	16 x 31	1930	18 x 35	2160	22 x 40					
10000	103	16 x 31	1920	16 x 35	2220	18 x 35	2350								
15000	153	18 x 31	2390												

μF	WV Code 代碼	100		160		200		250		350		400		450	
		2A		2C		2D		2E		2V		2G		2W	
1	010	5 x 11	19	5 x 11	16	5 x 11	16	6.3 x 11.5	16	6.3 x 11.5	16	6.3 x 11.5 (8 x 11.5)	16 (20)	8 x 11.5	17
2.2	2R2	5 x 11	30	6.3 x 11.5	23	6.3 x 11.5	30	6.3 x 11.5	35	8 x 11.5	38	6.3 x 11.5 (8 x 11.5)	32 (39)	8 x 11.5	39
3.3	3R3	5 x 11	32	6.3 x 11.5	34	6.3 x 11.5	39	8 x 11.5	42	8 x 11.5	43	6.3 x 11.5 (8 x 11.5)	40 (45)	8 x 11.5	45
4.7	4R7	5 x 11	38	6.3 x 11.5	40	8 x 11.5	46	8 x 11.5	45	10 x 12	55	8 x 11.5 (10 x 12)	50 (55)	10 x 12	55
6.8	6R8	5 x 11	52	8 x 11.5	48	8 x 11.5	52	8 x 11.5 (10 x 12)	52 (57)	10 x 16	62	8 x 16 (10 x 16)	65 (80)	10 x 16	90
10	100	6.3 x 11.5	73	8 x 11.5 (10 x 12)	65 (60)	8 x 11.5 (10 x 12)	65 (70)	10 x 12 (10 x 16)	92 (116)	10 x 16	95	10 x 16 (10 x 20)	95 (105)	10 x 20 (13 x 21)	120 (125)
22	220	6.3 x 11.5	104	10 x 12	96	8 x 16 (10x16)	115 (140)	10 x 16 (10 x 20)	140 (145)	13 x 21	220	13 x 21 (13 x 25) (16 x 20)	160 (170) (185)	13 x 25	185
33	330	8 x 11.5	150	10 x 20	155	10 x 20	170	13 x 21	190	13 x 25	215	13 x 25 (16 x 25)	185 (245)	16 x 20 (16 x 25)	207 (260)
47	470	10 x 12	190	13 x 21	220	13 x 21	220	13 x 25	250	16 x 25	285	16 x 25 (16 x 31)	295 (320)	16 x 25 (16 x 31)	305 (313)
68	680	10 x 16	239	13 x 21	275	13 x 25	270	16 x 25	365	16 x 31	370	16 x 31 (16 x 35)	350 (405)	16 x 35 (18 x 31)	435 (450)
100	101	10 x 20	320	13 x 25	355	16 x 25	385	16 x 31	485	18 x 35	485	18 x 31 (18 x 35)	420 (540)	18 x 35 (18 x 40)	520 (560)
220	221	13 x 25	450	16 x 31	660	16 x 35 (18 x 31)	695 (755)	18 x 35	760						
330	331	13 x 25	625	18 x 35	820	18 x 35 (18 x 40)	820 (965)								
470	471	16 x 25	780	18 x 40	975										
680	681	16 x 35	1021												

•Case size ØD×L(mm), ripple current (mA rms) at 105°C, 120Hz •尺寸ØD×L(mm), 紋波電流(mA rms)於 105°C, 120Hz

- Please refer to page 19 "Taping Specifications" & page 21 "Lead Forming & Cutting" about the taped or formed product spec. 編帶與引線成型標準請查閱第 19 頁 "編帶標準" 及第 21 頁 "引線成型與剪腳"。
- Please refer to page 20 "Packaging Specifications" for the minimum package quantity. 最小包裝數量請查閱第 20 頁 "包裝標準"。
- Please refer to page 16 for the Part Number System. 產品編碼規則請查閱第 16 頁。

Note: All design and specifications are for reference only and is subject to change without prior notice. If any doubt about safety for your application, please contact us immediately for technical assistance before purchase.
 注: 以上所提供的設計及特性參數僅供參考, 任何修改不作預先通知。如果在使用上有疑問, 請在採購前與我們聯繫, 以便提供技術上的協助。

CAT.2023/V2

RM Series

WIDE TEMPERATURE RANGE, HEIGHT 7(9)MM

7(9)MM 高, 寬溫品

- Super miniature series with 7(9)mm height
7(9)mm 高, 超小型系列
- High performance and excellent temperature characteristics
高性能和卓越的溫度特性
- Endurance 1000 hours
耐久性 1000 小時
- Comply with the RoHS & REACH
符合 RoHS 與 REACH

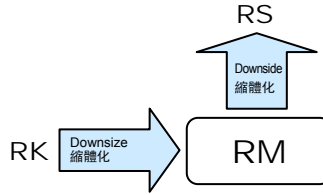
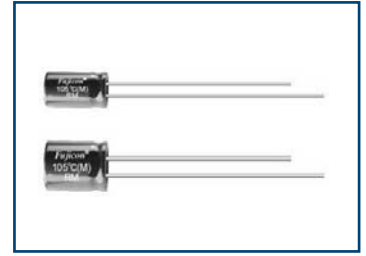

□ SPECIFICATIONS 特性表

Items 項目	Characteristics 主要特性																					
Category Temperature Range 工作溫度範圍	-40 ~ +105°C																					
Voltage Range 額定工作電壓範圍	4 ~ 63V																					
Capacitance Range 靜電容量範圍	0.1 ~ 1000μF																					
Capacitance Tolerance 靜電容量允許偏差	±20% at 120Hz, 20°C																					
Leakage Current 漏電流	Leakage current ≤0.01CV or 3μA, whichever is greater (after 2 minutes application of rated voltage at 20°C) 漏電流 ≤0.01CV 或 3μA, 取較大值 (在 20°C 環境中施加額定工作電壓 2 分鐘後) C: Nominal capacitance (μF) 標稱靜電容量, V: Rated voltage (V) 額定電壓																					
Dissipation Factor (tan δ) 損耗角正切	When nominal capacitance is over 1000μF, tan δ shall be added 0.02 to the listed value with increase of every 1000μF. 當標稱靜電容量大於 1000μF, 其標稱靜電容量每增加 1000μF, 損耗角正切增加 0.02. Measurement frequency 測試頻率: 120Hz, Temperature 溫度: 20°C <table border="1"> <tr> <td>Rated Voltage (V) 額定工作電壓</td> <td>4</td> <td>6.3</td> <td>10</td> <td>16</td> <td>25</td> <td>35</td> <td>50, 63</td> </tr> <tr> <td>tan δ (max.) 最大損耗角正切</td> <td>0.35</td> <td>0.24</td> <td>0.20</td> <td>0.16</td> <td>0.14</td> <td>0.12</td> <td>0.10</td> </tr> </table>	Rated Voltage (V) 額定工作電壓	4	6.3	10	16	25	35	50, 63	tan δ (max.) 最大損耗角正切	0.35	0.24	0.20	0.16	0.14	0.12	0.10					
Rated Voltage (V) 額定工作電壓	4	6.3	10	16	25	35	50, 63															
tan δ (max.) 最大損耗角正切	0.35	0.24	0.20	0.16	0.14	0.12	0.10															
Stability at Low Temperature 低溫特性	Measurement frequency 測試頻率: 120Hz <table border="1"> <tr> <td>Rated Voltage (V) 額定工作電壓</td> <td>4</td> <td>6.3</td> <td>10</td> <td>16</td> <td>25, 35</td> <td>50, 63</td> </tr> <tr> <td>Impedance Ratio 阻抗比</td> <td>Z(-25°C) / Z(20°C)</td> <td>6</td> <td>4</td> <td>3</td> <td>2</td> <td>2</td> </tr> <tr> <td></td> <td>Z(-40°C) / Z(20°C)</td> <td>12</td> <td>10</td> <td>8</td> <td>6</td> <td>4</td> </tr> </table>	Rated Voltage (V) 額定工作電壓	4	6.3	10	16	25, 35	50, 63	Impedance Ratio 阻抗比	Z(-25°C) / Z(20°C)	6	4	3	2	2		Z(-40°C) / Z(20°C)	12	10	8	6	4
Rated Voltage (V) 額定工作電壓	4	6.3	10	16	25, 35	50, 63																
Impedance Ratio 阻抗比	Z(-25°C) / Z(20°C)	6	4	3	2	2																
	Z(-40°C) / Z(20°C)	12	10	8	6	4																
Endurance 耐久性	After 1000 hours application of the rated voltage at 105°C, they meet the characteristics listed below. 在 105°C 環境中施加額定工作電壓 1000 小時後, 電容器的特性符合下表的要求。 <table border="1"> <tr> <td>Capacitance Change 靜電容量變化率</td> <td>Within ±20% of initial measured value 初始值的±20%以內</td> </tr> <tr> <td>Dissipation Factor 損耗角正切</td> <td>≤200% of initial specified value 不大於規範值的 200%</td> </tr> <tr> <td>Leakage Current 漏電流</td> <td>≤initial specified value 不大於規範值</td> </tr> </table>	Capacitance Change 靜電容量變化率	Within ±20% of initial measured value 初始值的±20%以內	Dissipation Factor 損耗角正切	≤200% of initial specified value 不大於規範值的 200%	Leakage Current 漏電流	≤initial specified value 不大於規範值															
Capacitance Change 靜電容量變化率	Within ±20% of initial measured value 初始值的±20%以內																					
Dissipation Factor 損耗角正切	≤200% of initial specified value 不大於規範值的 200%																					
Leakage Current 漏電流	≤initial specified value 不大於規範值																					
Shelf Life 高溫貯存特性	After leaving capacitors under no load at 105°C for 1000 hours, they meet the specified value for load life characteristics listed above. 在 105°C 環境中無負荷放置 1000 小時後, 電容器的特性符合高溫負荷特性中所列的規定值。																					
Marking 標識	Printed with white colour on black sleeve (PVC) or printed with white colour on green sleeve (PET). 黑色膠管白字印刷 (PVC) 或綠色膠管白字印刷 (PET)。																					

□ DRAWING & DIMENSIONS 外形圖及尺寸 (Unit: mm)

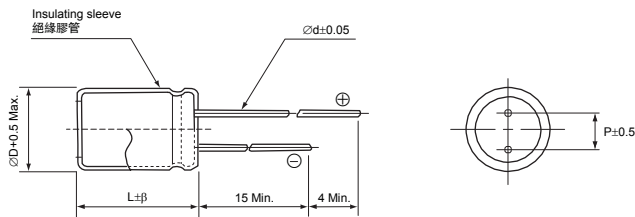

ØD	4	5	6.3	8
P	1.5	2.0	2.5	3.5
Ød	0.45			0.50
β	1.0			

Note: All design and specifications are for reference only and is subject to change without prior notice. If any doubt about safety for your application, please contact us immediately for technical assistance before purchase.

注: 以上所提供的設計及特性參數僅供參考, 任何修改不作預先通知。如果在使用上有疑問, 請在採購前與我們聯繫, 以便提供技術上的協助。

CAT.2023/V2

RM Series

□ DIMENSIONS & MAXIMUM PERMISSIBLE RIPPLE CURRENT 規格尺寸及最大允許紋波電流

μF	WV Code 代碼	4		6.3		10		16		25		35		50		63	
		0G		0J		1A		1C		1E		1V		1H		1J	
0.1	0R1													4 x 7	1	4 x 7	2.4
0.22	R22													4 x 7	2.3	4 x 7	3.2
0.33	R33													4 x 7	3.5	4 x 7	4
0.47	R47													4 x 7	5	4 x 7	6
0.68	R68													4 x 7	10	4 x 7	11
1	010													4 x 7	16	4 x 7	18
2.2	2R2													4 x 7	24	4 x 7	26
3.3	3R3													4 x 7	29	4 x 7	30
4.7	4R7											4 x 7	26	4 x 7	32	5 x 7	33
6.8	6R8											4 x 7	28	4 x 7	34	5 x 7	35
10	100							4 x 7	28	4 x 7	28	4 x 7 (5 x 7)	32 (40)	4 x 7 (5 x 7)	34 (44)	6.3 x 7	45
22	220					4 x 7	36	4 x 7	45	4 x 7 (5 x 7)	48 (50)	5 x 7	53	6.3 x 7	65	6.3 x 7	68
33	330					4 x 7	45	4 x 7	48	5 x 7	52	5 x 7	67	6.3 x 7	100	8 x 7	110
47	470			4 x 7	45	4 x 7	48	4 x 7 (5 x 7)	70 (80)	5 x 7 (6.3 x 7)	80 (85)	6.3 x 7	90	8 x 7	140		
68	680			4 x 7	45	5 x 7	80	5 x 7	85	6.3 x 7	105	6.3 x 7	120				
100	101	4 x 7	28	4 x 7 (5 x 7)	55 (85)	5 x 7	90	5 x 7 (6.3 x 7)	105 (125)	6.3 x 7 (8 x 7) (8 x 9)	125 (135) (170)	6.3 x 7 (8 x 7) (8 x 9)	135 (165) (200)				
220	221	5 x 7	65	6.3 x 7	110	6.3 x 7	125	6.3 x 7 (8 x 7) (8 x 9)	138 (145) (168)	8 x 9	179						
330	331	6.3 x 7	120	6.3 x 7	130	8 x 7 (8 x 9)	150 (170)	8 x 9	188								
470	471	6.3 x 7	150	6.3 x 7 (8 x 7) (8 x 9)	140 (160) (180)	8 x 9	190	8 x 9	200								Case size 尺寸
1000	102	8 x 9	215	8 x 9	230												Ripple current 紋波電流

•Case size $\varnothing D \times L$ (mm), ripple current (mA rms) at 105°C, 120Hz •尺寸 $\varnothing D \times L$ (mm), 紋波電流(mA rms)於 105°C, 120Hz

- Please refer to page 19 "Taping Specifications" & page 21 "Lead Forming & Cutting" about the taped or formed product spec. 編帶與引線成型標準請查閱第 19 頁 "編帶標準" 及第 21 頁 "引線成型與剪腳"。
- Please refer to page 20 "Packaging Specifications" for the minimum package quantity. 最小包裝數量請查閱第 20 頁 "包裝標準"。
- Please refer to page 16 for the Part Number System. 產品編碼規則請查閱第 16 頁。

Note: All design and specifications are for reference only and is subject to change without prior notice. If any doubt about safety for your application, please contact us immediately for technical assistance before purchase.

注：以上所提供的設計及特性參數僅供參考，任何修改不作預先通知。如果在使用上有疑問，請在採購前與我們聯繫，以便提供技術上的協助。

CAT.2023/V2

RS Series

WIDE TEMPERATURE RANGE, HEIGHT 5MM

5MM 高, 寬溫品

- Super miniature series with 5mm height
5mm 高, 超小型系列
- Suitable to replace tantalum capacitors at low cost
可替換價格較高的鉭電容器
- Endurance 1000 hours
耐久性 1000 小時
- Comply with the RoHS & REACH
符合 RoHS 與 REACH

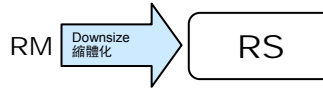
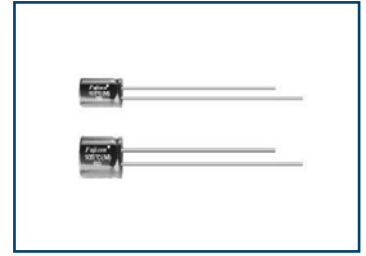

□ SPECIFICATIONS 特性表

Items 項目	Characteristics 主要特性																				
Category Temperature Range 工作溫度範圍	-40 ~ +105°C																				
Voltage Range 額定工作電壓範圍	4 ~ 63V																				
Capacitance Range 靜電容量範圍	0.1 ~ 470μF																				
Capacitance Tolerance 靜電容量允許偏差	±20% at 120Hz, 20°C																				
Leakage Current 漏電流	Leakage current ≤0.01CV or 3μA, whichever is greater (after 2 minutes application of rated voltage at 20°C) 漏電流 ≤0.01CV 或 3μA, 取較大值 (在 20°C 環境中施加額定工作電壓 2 分鐘後) C: Nominal capacitance (μF) 標稱靜電容量, V: Rated voltage (V) 額定電壓																				
Dissipation Factor (tan δ) 損耗角正切	Measurement frequency 測試頻率: 120Hz, Temperature 溫度: 20°C <table border="1"> <thead> <tr> <th>Rated Voltage (V) 額定工作電壓</th> <th>4</th> <th>6.3</th> <th>10</th> <th>16</th> <th>25</th> <th>35</th> <th>50</th> </tr> </thead> <tbody> <tr> <td>tan δ (max.) 最大損耗角正切</td> <td>0.35</td> <td>0.27</td> <td>0.23</td> <td>0.19</td> <td>0.15</td> <td>0.13</td> <td>0.11</td> </tr> </tbody> </table>	Rated Voltage (V) 額定工作電壓	4	6.3	10	16	25	35	50	tan δ (max.) 最大損耗角正切	0.35	0.27	0.23	0.19	0.15	0.13	0.11				
Rated Voltage (V) 額定工作電壓	4	6.3	10	16	25	35	50														
tan δ (max.) 最大損耗角正切	0.35	0.27	0.23	0.19	0.15	0.13	0.11														
Stability at Low Temperature 低溫特性	Measurement frequency 測試頻率: 120Hz <table border="1"> <thead> <tr> <th>Rated Voltage (V) 額定工作電壓</th> <th>4</th> <th>6.3</th> <th>10</th> <th>16</th> <th>25-50</th> </tr> </thead> <tbody> <tr> <td>Impedance Ratio 阻抗比</td> <td>Z(-25°C) / Z(20°C)</td> <td>7</td> <td>3</td> <td>3</td> <td>2</td> <td>2</td> </tr> <tr> <td></td> <td>Z(-40°C) / Z(20°C)</td> <td>12</td> <td>8</td> <td>5</td> <td>4</td> <td>3</td> </tr> </tbody> </table>	Rated Voltage (V) 額定工作電壓	4	6.3	10	16	25-50	Impedance Ratio 阻抗比	Z(-25°C) / Z(20°C)	7	3	3	2	2		Z(-40°C) / Z(20°C)	12	8	5	4	3
Rated Voltage (V) 額定工作電壓	4	6.3	10	16	25-50																
Impedance Ratio 阻抗比	Z(-25°C) / Z(20°C)	7	3	3	2	2															
	Z(-40°C) / Z(20°C)	12	8	5	4	3															
Endurance 耐久性	After 1000 hours application of the rated voltage at 105°C, they meet the characteristics listed below. 在 105°C 環境中施加額定工作電壓 1000 小時後, 電容器的特性符合下表的要求。 <table border="1"> <tbody> <tr> <td>Capacitance Change 靜電容量變化率</td> <td>Within ±25% of initial measured value 初始值的±25%以內</td> </tr> <tr> <td>Dissipation Factor 損耗角正切</td> <td>≤200% of initial specified value 不大於規範值的 200%</td> </tr> <tr> <td>Leakage Current 漏電流</td> <td>≤initial specified value 不大於規範值</td> </tr> </tbody> </table>	Capacitance Change 靜電容量變化率	Within ±25% of initial measured value 初始值的±25%以內	Dissipation Factor 損耗角正切	≤200% of initial specified value 不大於規範值的 200%	Leakage Current 漏電流	≤initial specified value 不大於規範值														
Capacitance Change 靜電容量變化率	Within ±25% of initial measured value 初始值的±25%以內																				
Dissipation Factor 損耗角正切	≤200% of initial specified value 不大於規範值的 200%																				
Leakage Current 漏電流	≤initial specified value 不大於規範值																				
Shelf Life 高溫貯存特性	After leaving capacitors under no load at 105°C for 1000 hours, they meet the specified value for load life characteristics listed above. 在 105°C 環境中無負荷放置 1000 小時後, 電容器的特性符合高溫負荷特性中所列的規定值。																				
Marking 標識	Printed with white colour on black sleeve (PVC) or printed with white colour on green and brown (∅3×5) sleeve (PET). 黑色膠管白字印刷 (PVC) 或綠色和褐色 (∅3×5) 膠管白字印刷 (PET)。																				

□ DRAWING & DIMENSIONS 外形圖及尺寸 (Unit: mm)

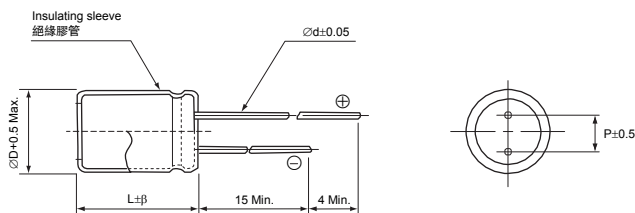

∅D	3	4	5	6.3	8
p	1.0	1.5	2.0	2.5	3.5
∅d	0.45				
β	1.0				

Note: All design and specifications are for reference only and is subject to change without prior notice. If any doubt about safety for your application, please contact us immediately for technical assistance before purchase.

注: 以上所提供的設計及特性參數僅供參考, 任何修改不作預先通知。如果在使用上有疑問, 請在採購前與我們聯繫, 以便提供技術上的協助。

CAT.2023/V2

RS Series

□ DIMENSIONS & MAXIMUM PERMISSIBLE RIPPLE CURRENT 規格尺寸及最大允許紋波電流

μF	WV Code 代碼	4		6.3		10		16		25		35		50	
		0G		0J		1A		1C		1E		1V		1H	
0.1	0R1													3 x 5 (4 x 5)	2.0 (2.4)
0.22	R22													3 x 5 (4 x 5)	3.0 (3.6)
0.33	R33													3 x 5 (4 x 5)	3.7 (4.4)
0.47	R47													3 x 5 (4 x 5)	4.4 (5.2)
0.68	R68													3 x 5 (4 x 5)	5.3 (6.3)
1	010													3 x 5 (4 x 5)	6.4 (7.7)
2.2	2R2													3 x 5 (4 x 5)	9.5 (11)
3.3	3R3											3 x 5 (4 x 5)	9 (11)	4 x 5	14
4.7	4R7									3 x 5 (4 x 5)	10 (12)	4 x 5	13	4 x 5 (5 x 5)	16 (19)
6.8	6R8					3 x 5	11	3 x 5	14	4 x 5	15	4 x 5	17	5 x 5	23
10	100			3 x 5 (4 x 5)	13 (15)	3 x 5 (4 x 5)	14 (17)	3 x 5 (4 x 5)	16 (16)	4 x 5	19	5 x 5	22	5 x 5 (6.3 x 5)	28 (33)
22	220	3 x 5 (4 x 5)	16 (16)	3 x 5 (4 x 5)	18 (19)	3 x 5 (4 x 5)	20 (22)	4 x 5	29	5 x 5	34	5 x 5	36	6.3 x 5	40
33	330	4 x 5	20	4 x 5	23	4 x 5	29	5 x 5	37	5 x 5	45	6.3 x 5	50	8 x 5	58
47	470	4 x 5	24	4 x 5	28	5 x 5	35	5 x 5 (6.3 x 5)	46 (49)	6.3 x 5	54	6.3 x 5	62	8 x 5	71
68	680	5 x 5	36	5 x 5	46	5 x 5	47	6.3 x 5	52	6.3 x 5	63	8 x 5	105		
100	101	5 x 5	41	5 x 5	50	5 x 5 (6.3 x 5)	50 (52)	6.3 x 5 (8 x 5)	58 (72)	8 x 5	90				
220	221	6.3 x 5	56	6.3 x 5	60	6.3 x 5 (8 x 5)	65 (78)	8 x 5	86						
330	331	8 x 5	80	8 x 5	86	8 x 5	90							Case size 尺寸	Ripple current 紋波電流
470	471	8 x 5	88	8 x 5	96										

•Case size $\varnothing D \times L$ (mm), ripple current (mA rms) at 105°C, 120Hz •尺寸 $\varnothing D \times L$ (mm), 紋波電流(mA rms)於 105°C, 120Hz

- Please refer to page 19 "Taping Specifications" & page 21 "Lead Forming & Cutting" about the taped or formed product spec. 編帶與引線成型標準請查閱第 19 頁 "編帶標準" 及第 21 頁 "引線成型與剪腳"。
- Please refer to page 20 "Packaging Specifications" for the minimum package quantity. 最小包裝數量請查閱第 20 頁 "包裝標準"。
- Please refer to page 16 for the Part Number System. 產品編碼規則請查閱第 16 頁。

Note: All design and specifications are for reference only and is subject to change without prior notice. If any doubt about safety for your application, please contact us immediately for technical assistance before purchase.

注：以上所提供的設計及特性參數僅供參考，任何修改不作預先通知。如果在使用上有疑問，請在採購前與我們聯繫，以便提供技術上的協助。

CAT.2023/V2

LA Series

LOW LEAKAGE CURRENT

低漏電流品

- Standard low leakage current series
低漏電流標準型系列
- Suitable for high gain audio coupling applications
適用於高增益音頻耦合器材
- Stable leakage current characteristics for a long period
使漏電流特性處於長週期穩定
- Endurance 2000 hours at 85°C
在 85°C 環境中耐久性 2000 小時
- Comply with the RoHS & REACH
符合 RoHS 與 REACH

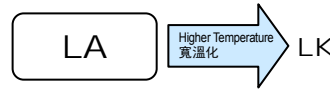
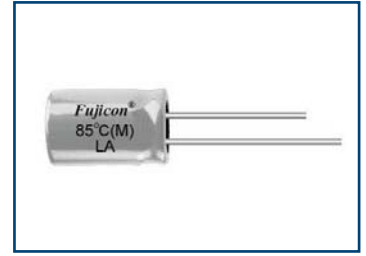

□ SPECIFICATIONS 特性表

Items 項目	Characteristics 主要特性															
Category Temperature Range 工作溫度範圍	-40 ~ +85°C															
Voltage Range 額定工作電壓範圍	10 ~ 100V															
Capacitance Range 靜電容量範圍	1 ~ 4700μF															
Capacitance Tolerance 靜電容量允許偏差	±20% at 120Hz, 20°C															
Leakage Current 漏電流	Leakage current ≤0.002CV or 0.4μA, whichever is greater (after 2 minutes application of rated voltage at 20°C) 漏電流 ≤0.002CV 或 0.4μA, 取較大值 (在 20°C 環境中施加額定工作電壓 2 分鐘後) C: Nominal capacitance (μF) 標稱靜電容量, V: Rated voltage (V) 額定電壓															
Dissipation Factor (tan δ) 損耗角正切	When nominal capacitance is over 1000μF, tan δ shall be added 0.02 to the listed value with increase of every 1000μF. 當標稱靜電容量大於 1000μF, 其標稱靜電容量每增加 1000μF, 損耗角正切增加 0.02. Measurement frequency 測試頻率: 120Hz, Temperature 溫度: 20°C															
Stability at Low Temperature 低溫特性	Measurement frequency 測試頻率: 120Hz															
	<table border="1"> <thead> <tr> <th>Rated Voltage (V) 額定工作電壓</th> <th>10</th> <th>16</th> <th>25</th> <th>35</th> <th>50</th> <th>63</th> <th>100</th> </tr> </thead> <tbody> <tr> <td>tan δ (max.) 最大損耗角正切</td> <td>0.20</td> <td>0.16</td> <td>0.14</td> <td>0.12</td> <td>0.10</td> <td>0.09</td> <td>0.08</td> </tr> </tbody> </table>	Rated Voltage (V) 額定工作電壓	10	16	25	35	50	63	100	tan δ (max.) 最大損耗角正切	0.20	0.16	0.14	0.12	0.10	0.09
Rated Voltage (V) 額定工作電壓	10	16	25	35	50	63	100									
tan δ (max.) 最大損耗角正切	0.20	0.16	0.14	0.12	0.10	0.09	0.08									
Endurance 耐久性	After 2000 hours application of the rated voltage at 85°C, they meet the characteristics listed below. 在 85°C 環境中施加額定工作電壓 2000 小時後, 電容器的特性符合下表的要求。															
	Capacitance Change 靜電容量變化率	Within ±20% of initial measured value 初始值的±20%以內														
	Dissipation Factor 損耗角正切	≤200% of initial specified value 不大於規範值的 200%														
Shelf Life 高溫貯存特性	Leakage Current 漏電流	≤initial specified value 不大於規範值														
	After leaving capacitors under no load at 85°C for 1000 hours, they meet the specified value for load life characteristics listed above. 在 85°C 環境中無負荷放置 1000 小時後, 電容器的特性符合高溫負荷特性中所列的規定值。															
Marking 標識	Printed with black colour on orange sleeve (PVC) or printed with white colour on green sleeve (PET). 桔紅色膠管黑字印刷 (PVC) 或綠色膠管白字印刷 (PET)。															

□ DRAWING & DIMENSIONS 外形圖及尺寸 (Unit: mm)

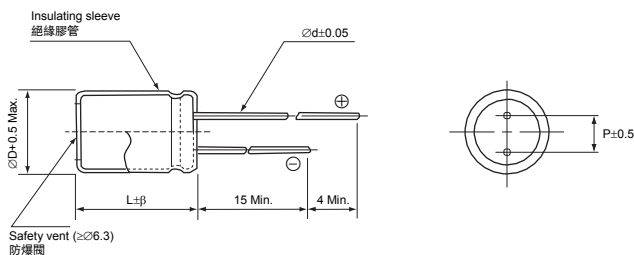

ØD	5	6.3	8 (L≤11.5)	8 (L≥16)	10	13	16
P	2.0	2.5	3.5		5.0		7.5
Ød	0.5			0.6		0.8	
β	1.5				2.0		

Note: All design and specifications are for reference only and is subject to change without prior notice. If any doubt about safety for your application, please contact us immediately for technical assistance before purchase.

注: 以上所提供的設計及特性參數僅供參考, 任何修改不作預先通知。如果在使用上有疑問, 請在採購前與我們聯繫, 以便提供技術上的協助。

CAT.2023/V2

LA Series

DIMENSIONS & MAXIMUM PERMISSIBLE RIPPLE CURRENT 規格尺寸及最大允許紋波電流

μF	WV Code 代碼	10		16		25		35		50		63		100			
		1A		1C		1E		1V		1H		1J		2A			
1	010											5 x 11	22	5 x 11	18		
1.5	1R5											5 x 11	25	5 x 11	22		
2.2	2R2									5 x 11	28	5 x 11	30	5 x 11	26		
3.3	3R3									5 x 11	35	5 x 11	37	5 x 11	32		
4.7	4R7									5 x 11	42	5 x 11	44	5 x 11	38		
6.8	6R8							5 x 11	46	5 x 11	50	5 x 11	53	5 x 11	53		
10	100					5 x 11	55	5 x 11	55	5 x 1	70	5 x 11	73	6.3 x 11.5	76		
15	150			5 x 11	61	5 x 11	68	5 x 11	68	5 x 11	85	5 x 11	106	6.3 x 11.5	93		
22	220	5 x 11	69	5 x 11	73	5 x 11	82	5 x 11	94	5 x 11	122	6.3 x 11.5	129	6.3 x 11.5	130		
33	330	5 x 11	84	5 x 11	90	5 x 11	116	5 x 11	116	6.3 x 11.5	149	6.3 x 11.5	183	8 x 11.5	175		
47	470	5 x 11	101	5 x 11	110	5 x 11	115	6.3 x 11.5	145	6.3 x 11.5	150	8 x 11.5	190	10 x 12	227		
68	680	5 x 11	120	5 x 11	138	5 x 11	160	6.3 x 11.5	203	8 x 11.5	210	8 x 11.5	270	10 x 16	313		
100	101	5 x 11	145	5 x 11 (6.3x11.5)	145 (180)	6.3 x 11.5	190	8 x 11.5	240	8 x 11.5	255	10 x 12	320	10 x 20	380		
150	151	5 x 11	169	6.3 x 11.5	240	8 x 11.5	270	8 x 11.5	340	10 x 12	360	10 x 16	450	13 x 21	508		
220	221	6.3 x 11.5	250	6.3 x 11.5	300	8 x 11.5	320	10 x 12	420	10 x 16	490	10 x 20	565	13 x 25	699		
330	331	6.3 x 11.5	300	8 x 11.5	370	8 x 11.5	470	10 x 12	570	10 x 20	650	13 x 21	765	16 x 25	983		
470	471	8 x 11.5	415	8 x 11.5	510	10 x 12	620	10 x 20	740	13 x 21	860	13 x 25	990	16 x 31	1320		
680	681	8 x 11.5	580	10 x 16	715	10 x 16	860	10 x 20	1050	13 x 25	1200	16 x 25	1380				
1000	102	10 x 12	790	10 x 20	910	10 x 20	1090	13 x 21	1300	16 x 25	1530						
1500	152	10 x 20	1100	10 x 20	1275	13 x 25	1530	16 x 25	1820								
2200	222	13 x 21	1240	13 x 25	1420	16 x 25	1660										
3300	332	13 x 21	1590	13 x 25	1840												
4700	472	13 x 25	1980														
																Case size 尺寸	Ripple current 紋波電流

•Case size $\varnothing D \times L$ (mm), ripple current (mA rms) at 85°C, 120Hz •尺寸 $\varnothing D \times L$ (mm), 紋波電流(mA rms)於 85°C, 120Hz

- Please refer to page 19 "Taping Specifications" & page 21 "Lead Forming & Cutting" about the taped or formed product spec. 編帶與引線成型標準請查閱第 19 頁 "編帶標準" 及第 21 頁 "引線成型與剪腳"。
- Please refer to page 20 "Packaging Specifications" for the minimum package quantity. 最小包裝數量請查閱第 20 頁 "包裝標準"。
- Please refer to page 16 for the Part Number System. 產品編碼規則請查閱第 16 頁。

Note: All design and specifications are for reference only and is subject to change without prior notice. If any doubt about safety for your application, please contact us immediately for technical assistance before purchase.

注：以上所提供的設計及特性參數僅供參考，任何修改不作預先通知。如果在使用上有疑問，請在採購前與我們聯繫，以便提供技術上的協助。

CAT.2023/V2

LK Series

LOW LEAKAGE CURRENT, WIDE TEMPERATURE RANGE

低漏電流寬溫品

- Wide operating temperature range of -40~+105°C
適用於 -40~+105°C 的寬溫範圍
- Low leakage current series
低漏電流系列
- For Hi-Fi sound audio systems
適用於高保真音響設備
- Comply with the RoHS & REACH
符合 RoHS 與 REACH

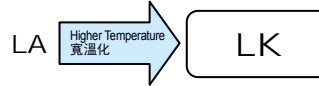

SPECIFICATIONS 特性表

Items 項目	Characteristics 主要特性														
Category Temperature Range 工作溫度範圍	-40 ~ +105°C														
Voltage Range 額定工作電壓範圍	10 ~ 50V														
Capacitance Range 靜電容量範圍	0.1 ~ 330μF														
Capacitance Tolerance 靜電容量允許偏差	±20% at 120Hz, 20°C														
Leakage Current 漏電流	Leakage current ≤0.002CV or 0.4μA, whichever is greater (after 2 minutes application of rated voltage at 20°C) 漏電流 ≤0.002CV 或 0.4μA, 取較大值 (在 20°C 環境中施加額定工作電壓 2 分鐘後) C: Nominal capacitance (μF) 標稱靜電容量, V: Rated voltage (V) 額定電壓														
Dissipation Factor (tan δ) 損耗角正切	When nominal capacitance is over 1000μF, tan δ shall be added 0.02 to the listed value with increase of every 1000μF. 當標稱靜電容量大於 1000μF, 其標稱靜電容量每增加 1000μF, 損耗角正切增加 0.02。 Measurement frequency 測試頻率: 120Hz, Temperature 溫度: 20°C <table border="1"> <thead> <tr> <th>Rated Voltage (V) 額定工作電壓</th> <th>10</th> <th>16</th> <th>25</th> <th>35</th> <th>50</th> </tr> </thead> <tbody> <tr> <td>tan δ (max.) 最大損耗角正切</td> <td>0.20</td> <td>0.16</td> <td>0.14</td> <td>0.12</td> <td>0.10</td> </tr> </tbody> </table>	Rated Voltage (V) 額定工作電壓	10	16	25	35	50	tan δ (max.) 最大損耗角正切	0.20	0.16	0.14	0.12	0.10		
Rated Voltage (V) 額定工作電壓	10	16	25	35	50										
tan δ (max.) 最大損耗角正切	0.20	0.16	0.14	0.12	0.10										
Stability at Low Temperature 低溫特性	Measurement frequency 測試頻率: 120Hz <table border="1"> <thead> <tr> <th>Rated Voltage (V) 額定工作電壓</th> <th>10</th> <th>16</th> <th>25 ~ 50</th> </tr> </thead> <tbody> <tr> <td>Impedance Ratio 阻抗比</td> <td>Z(-25°C) / Z(20°C)</td> <td>3</td> <td>2</td> <td>2</td> </tr> <tr> <td></td> <td>Z(-40°C) / Z(20°C)</td> <td>6</td> <td>6</td> <td>4</td> </tr> </tbody> </table>	Rated Voltage (V) 額定工作電壓	10	16	25 ~ 50	Impedance Ratio 阻抗比	Z(-25°C) / Z(20°C)	3	2	2		Z(-40°C) / Z(20°C)	6	6	4
Rated Voltage (V) 額定工作電壓	10	16	25 ~ 50												
Impedance Ratio 阻抗比	Z(-25°C) / Z(20°C)	3	2	2											
	Z(-40°C) / Z(20°C)	6	6	4											
Endurance 耐久性	After 1000 hours application of the rated voltage at 105°C, they meet the characteristics listed below. 在 105°C 環境中施加額定工作電壓 1000 小時後, 電容器的特性符合下表的要求。 <table border="1"> <thead> <tr> <th>Capacitance Change 靜電容量變化率</th> <th>Within ±20% of initial measured value 初始值的±20%以內</th> </tr> </thead> <tbody> <tr> <td>Dissipation Factor 損耗角正切</td> <td>≤200% of initial specified value 不大於規範值的 200%</td> </tr> <tr> <td>Leakage Current 漏電流</td> <td>≤initial specified value 不大於規範值</td> </tr> </tbody> </table>	Capacitance Change 靜電容量變化率	Within ±20% of initial measured value 初始值的±20%以內	Dissipation Factor 損耗角正切	≤200% of initial specified value 不大於規範值的 200%	Leakage Current 漏電流	≤initial specified value 不大於規範值								
Capacitance Change 靜電容量變化率	Within ±20% of initial measured value 初始值的±20%以內														
Dissipation Factor 損耗角正切	≤200% of initial specified value 不大於規範值的 200%														
Leakage Current 漏電流	≤initial specified value 不大於規範值														
Shelf Life 高溫貯存特性	After leaving capacitors under no load at 105°C for 1000 hours, they meet the specified value for load life characteristics listed above. 在 105°C 環境中無負荷放置 1000 小時後, 電容器的特性符合高溫負荷特性中所列的規定值。														
Marking 標識	Printed with black colour on orange sleeve (PVC) or printed with white colour on green sleeve (PET). 桔紅色膠管黑字印刷 (PVC) 或綠色膠管白字印刷 (PET)。														

DRAWING & DIMENSIONS 外形圖及尺寸 (Unit: mm)

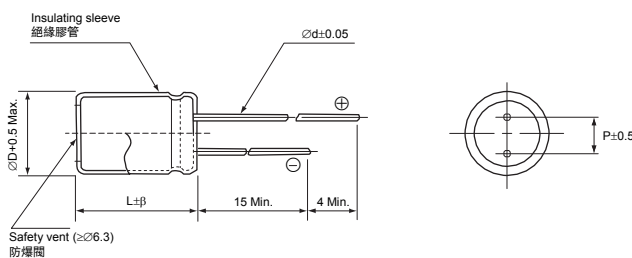

ØD	5	6.3	8 (L≤11.5)	8 (L≤16)	10
P	2.0	2.5	3.5		5.0
Ød	0.5			0.6	
β	1.5				

Note: All design and specifications are for reference only and is subject to change without prior notice. If any doubt about safety for your application, please contact us immediately for technical assistance before purchase.

注: 以上所提供的設計及特性參數僅供參考, 任何修改不作預先通知。如果在使用上有疑問, 請在採購前與我們聯繫, 以便提供技術上的協助。

CAT.2023/V2

LK Series

DIMENSIONS & MAXIMUM PERMISSIBLE RIPPLE CURRENT 規格尺寸及最大允許紋波電流

WV Code 代碼	10		16		25		35		50		
	1A	1C	1E	1V	1H						
0.47	R47									5 x 11	9.6
0.68	R68									5 x 11	11
1	010									5 x 11	14
1.5	1R5									5 x 11	17
2.2	2R2									5 x 11	21
3.3	3R3									5 x 11	25
4.7	4R7									5 x 11	30
6.8	6R8									5 x 11	36
10	100									5 x 11	44
15	150							5 x 11	54	5 x 11	62
22	220			5 x 11	54	5 x 11	57	5 x 11	61	5 x 11	68
33	330			5 x 11	64	5 x 11	69	5 x 11	75	6.3 x 11.5	90
47	470	5 x 11	70	5 x 11	79	5 x 11	82	6.3 x 11.5	100	6.3 x 11.5	110
68	680	5 x 11	96	5 x 11	108	5 x 11	115	6.3 x 11.5	156	8 x 11.5	150
100	101	5 x 11	105	5 x 11 (6.3 x 11.5)	115 (125)	6.3 x 11.5	135	8 x 11.5	170	8 x 11.5	180
150	151	5 x 11	150	6.3 x 11.5	175	8 x 11.5	190	10 x 12	245	10 x 12	285
220	221	6.3 x 11.5	175	6.3 x 11.5	205	8 x 11.5	230	10 x 12	300	10 x 16	390
330	331	6.3 x 11.5	245	8 x 11.5	285	8 x 11.5	345	10 x 16	400		
470	471	8 x 11.5	355	8 x 11.5	365	10 x 12	470	10 x 20	565	Case size 尺寸	Ripple current 紋波電流
1000	102	10 x 12	600	10 x 16	745	10 x 20	850				

•Case size $\varnothing D \times L$ (mm), ripple current (mA rms) at 105°C, 120Hz •尺寸 $\varnothing D \times L$ (mm), 紋波電流(mA rms)於 105°C, 120Hz

- Please refer to page 19 "Taping Specifications" & page 21 "Lead Forming & Cutting" about the taped or formed product spec. 編帶與引線成型標準請查閱第 19 頁“編帶標準”及第 21 頁“引線成型與剪腳”。
- Please refer to page 20 "Packaging Specifications" for the minimum package quantity. 最小包裝數量請查閱第 20 頁“包裝標準”。
- Please refer to page 16 for the Part Number System. 產品編碼規則請查閱第 16 頁。

Note: All design and specifications are for reference only and is subject to change without prior notice. If any doubt about safety for your application, please contact us immediately for technical assistance before purchase.

注：以上所提供的設計及特性參數僅供參考，任何修改不作預先通知。如果在使用上有疑問，請在採購前與我們聯繫，以便提供技術上的協助。

CAT.2023/V2

LM Series

LOW LEAKAGE CURRENT, HEIGHT 7MM

7MM 高, 低漏電流品

- Low leakage current series with 7mm height
7mm 高, 低漏電流品系列
- Endurance 1000 hours
耐久性 1000 小時
- Comply with the RoHS & REACH
符合 RoHS 與 REACH

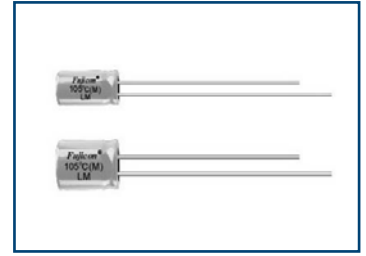

□ SPECIFICATIONS 特性表

Items 項目	Characteristics 主要特性															
Category Temperature Range 工作溫度範圍	-40 ~ +105°C															
Voltage Range 額定工作電壓範圍	6.3 ~ 63V															
Capacitance Range 靜電容量範圍	0.1 ~ 220µF															
Capacitance Tolerance 靜電容量允許偏差	±20% at 120Hz, 20°C															
Leakage Current 漏電流	Leakage current ≤0.002CV or 0.4µA, whichever is greater (after 2 minutes application of rated voltage at 20°C) 漏電流 ≤0.002CV 或 0.4µA, 取較大值 (在 20°C 環境中施加額定工作電壓 2 分鐘後) C: Nominal capacitance (µF) 標稱靜電容量, V: Rated voltage (V) 額定電壓															
Dissipation Factor (tan δ) 損耗角正切	Measurement frequency 測試頻率: 120Hz, Temperature 溫度: 20°C <table border="1"> <thead> <tr> <th>Rated Voltage (V) 額定工作電壓</th> <th>6.3</th> <th>10</th> <th>16</th> <th>25</th> <th>35</th> <th>50, 63</th> </tr> </thead> <tbody> <tr> <td>tan δ (max.) 最大損耗角正切</td> <td>0.24</td> <td>0.20</td> <td>0.16</td> <td>0.14</td> <td>0.12</td> <td>0.10</td> </tr> </tbody> </table>	Rated Voltage (V) 額定工作電壓	6.3	10	16	25	35	50, 63	tan δ (max.) 最大損耗角正切	0.24	0.20	0.16	0.14	0.12	0.10	
Rated Voltage (V) 額定工作電壓	6.3	10	16	25	35	50, 63										
tan δ (max.) 最大損耗角正切	0.24	0.20	0.16	0.14	0.12	0.10										
Stability at Low Temperature 低溫特性	Measurement frequency 測試頻率: 120Hz <table border="1"> <thead> <tr> <th>Rated Voltage (V) 額定工作電壓</th> <th>6.3</th> <th>10</th> <th>16~25</th> <th>35~63</th> </tr> </thead> <tbody> <tr> <td>Impedance Ratio 阻抗比</td> <td>Z(-25°C) / Z(20°C)</td> <td>4</td> <td>3</td> <td>2</td> </tr> <tr> <td></td> <td>Z(-40°C) / Z(20°C)</td> <td>10</td> <td>6</td> <td>4</td> </tr> </tbody> </table>	Rated Voltage (V) 額定工作電壓	6.3	10	16~25	35~63	Impedance Ratio 阻抗比	Z(-25°C) / Z(20°C)	4	3	2		Z(-40°C) / Z(20°C)	10	6	4
Rated Voltage (V) 額定工作電壓	6.3	10	16~25	35~63												
Impedance Ratio 阻抗比	Z(-25°C) / Z(20°C)	4	3	2												
	Z(-40°C) / Z(20°C)	10	6	4												
Endurance 耐久性	After 1000 hours application of the rated voltage at 105°C, they meet the characteristics listed below. 在 105°C 環境中施加額定工作電壓 1000 小時後, 電容器的特性符合下表的要求。 <table border="1"> <tbody> <tr> <td>Capacitance Change 靜電容量變化率</td> <td>Within ±20% of initial measured value 初始值的±20%以內</td> </tr> <tr> <td>Dissipation Factor 損耗角正切</td> <td>≤200% of initial specified value 不大於規範值的 200%</td> </tr> <tr> <td>Leakage Current 漏電流</td> <td>≤initial specified value 不大於規範值</td> </tr> </tbody> </table>	Capacitance Change 靜電容量變化率	Within ±20% of initial measured value 初始值的±20%以內	Dissipation Factor 損耗角正切	≤200% of initial specified value 不大於規範值的 200%	Leakage Current 漏電流	≤initial specified value 不大於規範值									
Capacitance Change 靜電容量變化率	Within ±20% of initial measured value 初始值的±20%以內															
Dissipation Factor 損耗角正切	≤200% of initial specified value 不大於規範值的 200%															
Leakage Current 漏電流	≤initial specified value 不大於規範值															
Shelf Life 高溫貯存特性	After leaving capacitors under no load at 105°C for 500 hours, they meet the specified value for load life characteristics listed above. 在 105°C 環境中無負荷放置 500 小時後, 電容器的特性符合高溫負荷特性中所列的規定值。															
Marking 標識	Printed with black colour on orange sleeve (PVC) or printed with white colour on green sleeve (PET). 桔紅色膠管黑字印刷 (PVC) 或綠色膠管白字印刷 (PET)。															

□ DRAWING & DIMENSIONS 外形圖及尺寸 (Unit: mm)

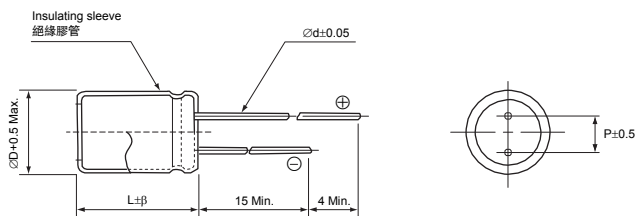

ØD	4	5	6.3
p	1.5	2.0	2.5
Ød	0.45		
β	1.0		

Note: All design and specifications are for reference only and is subject to change without prior notice. If any doubt about safety for your application, please contact us immediately for technical assistance before purchase.

注: 以上所提供的設計及特性參數僅供參考, 任何修改不作預先通知。如果在使用上有疑問, 請在採購前與我們聯繫, 以便提供技術上的協助。

CAT.2023/V2

LM Series

□ DIMENSIONS & MAXIMUM PERMISSIBLE RIPPLE CURRENT 規格尺寸及最大允許紋波電流

μF	WV Code 代碼	6.3		10		16		25		35		50		63	
		0J		1A		1C		1E		1V		1H		1J	
0.1	0R1											4 x 7	1	4 x 7	2.4
0.22	R22											4 x 7	2	4 x 7	3.2
0.33	R33											4 x 7	3.5	4 x 7	4
0.47	R47											4 x 7	5	4 x 7	6
0.68	R68											4 x 7	7	4 x 7	9
1	010											4 x 7	10	4 x 7	16
2.2	2R2											4 x 7	15	4 x 7	18
3.3	3R3									4 x 7	16	4 x 7	18	4 x 7	20
4.7	4R7									4 x 7	18	4 x 7	22	4 x 7	26
6.8	6R8							4 x 7	18	4 x 7	24	4 x 7	28	5 x 7	32
10	100					4 x 7	29	4 x 7	33	5 x 7	36	5 x 7	44	6.3 x 7	48
22	220	4 x 7	34	4 x 7	38	4 x 7	44	5 x 7	51	5 x 7	57	6.3 x 7	65	8 x 7	74
33	330	4 x 7	42	4 x 7	47	4 x 7	57	5 x 7	63	6.3 x 7	72	8 x 7	85		
47	470	4 x 7	50	5 x 7	59	5 x 7	68	6.3 x 7	78	8 x 7	85				
68	680	5 x 7	72	6.3 x 7	78	6.3 x 7	82	8 x 7	95						
100	101	6.3 x 7	76	8 x 7	96	8 x 7	105								
220	221	8 x 7	130												Case size 尺寸
															Ripple current 紋波電流

•Case size $\varnothing D \times L$ (mm), ripple current (mA rms) at 105°C, 120Hz •尺寸 $\varnothing D \times L$ (mm), 紋波電流(mA rms)於 105°C, 120Hz

- Please refer to page 19 "Taping Specifications" & page 21 "Lead Forming & Cutting" about the taped or formed product spec. 編帶與引線成型標準請查閱第 19 頁“編帶標準”及第 21 頁“引線成型與剪腳”。
- Please refer to page 20 "Packaging Specifications" for the minimum package quantity. 最小包裝數量請查閱第 20 頁“包裝標準”。
- Please refer to page 16 for the Part Number System. 產品編碼規則請查閱第 16 頁。

Note: All design and specifications are for reference only and is subject to change without prior notice. If any doubt about safety for your application, please contact us immediately for technical assistance before purchase.

注：以上所提供的設計及特性參數僅供參考，任何修改不作預先通知。如果在使用上有疑問，請在採購前與我們聯繫，以便提供技術上的協助。

CAT.2023/V2

LS Series

LOW LEAKAGE CURRENT, HEIGHT 5MM

5MM 高, 低漏電流品

- Low leakage current series with 5mm height
5mm 高, 低漏電流品系列
- Designed for use in lightweight and portable equipment
適用於小型及便攜器材
- Endurance 1000 hours
耐久性 1000 小時
- Comply with the RoHS & REACH
符合 RoHS 與 REACH

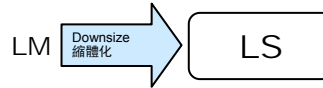
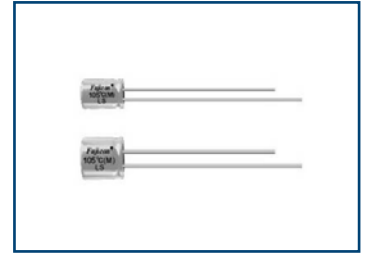

□ SPECIFICATIONS 特性表

Items 項目	Characteristics 主要特性																					
Category Temperature Range 工作溫度範圍	-40 ~ +105°C																					
Voltage Range 額定工作電壓範圍	4 ~ 50V																					
Capacitance Range 靜電容量範圍	0.1 ~ 100μF																					
Capacitance Tolerance 靜電容量允許偏差	±20% at 120Hz, 20°C																					
Leakage Current 漏電流	Leakage current ≤0.002CV or 0.4μA, whichever is greater (after 2 minutes application of rated voltage at 20°C) 漏電流 ≤0.002CV 或 0.4μA, 取較大值 (在 20°C 環境中施加額定工作電壓 2 分鐘後) C: Nominal capacitance (μF) 標稱靜電容量, V: Rated voltage (V) 額定電壓																					
Dissipation Factor (tan δ) 損耗角正切	Measurement frequency 測試頻率: 120Hz, Temperature 溫度: 20°C <table border="1"> <thead> <tr> <th>Rated Voltage (V) 額定工作電壓</th> <th>4</th> <th>6.3</th> <th>10</th> <th>16</th> <th>25</th> <th>35</th> <th>50</th> </tr> </thead> <tbody> <tr> <td>tan δ (max.) 最大損耗角正切</td> <td>0.35</td> <td>0.24</td> <td>0.20</td> <td>0.16</td> <td>0.14</td> <td>0.12</td> <td>0.10</td> </tr> </tbody> </table>	Rated Voltage (V) 額定工作電壓	4	6.3	10	16	25	35	50	tan δ (max.) 最大損耗角正切	0.35	0.24	0.20	0.16	0.14	0.12	0.10					
Rated Voltage (V) 額定工作電壓	4	6.3	10	16	25	35	50															
tan δ (max.) 最大損耗角正切	0.35	0.24	0.20	0.16	0.14	0.12	0.10															
Stability at Low Temperature 低溫特性	Measurement frequency 測試頻率: 120Hz <table border="1"> <thead> <tr> <th>Rated Voltage (V) 額定工作電壓</th> <th>4</th> <th>6.3</th> <th>10</th> <th>16</th> <th>25</th> <th>35, 50</th> </tr> </thead> <tbody> <tr> <td>Impedance Ratio 阻抗比</td> <td>Z(-25°C) / Z(20°C)</td> <td>7</td> <td>4</td> <td>3</td> <td>2</td> <td>2</td> </tr> <tr> <td></td> <td>Z(-40°C) / Z(20°C)</td> <td>15</td> <td>10</td> <td>8</td> <td>6</td> <td>4</td> </tr> </tbody> </table>	Rated Voltage (V) 額定工作電壓	4	6.3	10	16	25	35, 50	Impedance Ratio 阻抗比	Z(-25°C) / Z(20°C)	7	4	3	2	2		Z(-40°C) / Z(20°C)	15	10	8	6	4
Rated Voltage (V) 額定工作電壓	4	6.3	10	16	25	35, 50																
Impedance Ratio 阻抗比	Z(-25°C) / Z(20°C)	7	4	3	2	2																
	Z(-40°C) / Z(20°C)	15	10	8	6	4																
Endurance 耐久性	After 1000 hours application of the rated voltage at 105°C, they meet the characteristics listed below. 在 105°C 環境中施加額定工作電壓 1000 小時後, 電容器的特性符合下表的要求。 <table border="1"> <thead> <tr> <th>Capacitance Change 靜電容量變化率</th> <th>Within ±20% of initial measured value 初始值的±20%以內</th> </tr> </thead> <tbody> <tr> <td>Dissipation Factor 損耗角正切</td> <td>≤200% of initial specified value 不大於規範值的 200%</td> </tr> <tr> <td>Leakage Current 漏電流</td> <td>≤initial specified value 不大於規範值</td> </tr> </tbody> </table>	Capacitance Change 靜電容量變化率	Within ±20% of initial measured value 初始值的±20%以內	Dissipation Factor 損耗角正切	≤200% of initial specified value 不大於規範值的 200%	Leakage Current 漏電流	≤initial specified value 不大於規範值															
Capacitance Change 靜電容量變化率	Within ±20% of initial measured value 初始值的±20%以內																					
Dissipation Factor 損耗角正切	≤200% of initial specified value 不大於規範值的 200%																					
Leakage Current 漏電流	≤initial specified value 不大於規範值																					
Shelf Life 高溫貯存特性	After leaving capacitors under no load at 105°C for 500 hours, they meet the specified value for load life characteristics listed above. 在 105°C 環境中無負荷放置 500 小時後, 電容器的特性符合高溫負荷特性中所列的規定值。																					
Marking 標識	Printed with black colour on orange sleeve (PVC) or printed with white colour on green sleeve (PET). 桔紅色膠管黑字印刷 (PVC) 或綠色膠管白字印刷 (PET)。																					

□ DRAWING & DIMENSIONS 外形圖及尺寸 (Unit: mm)

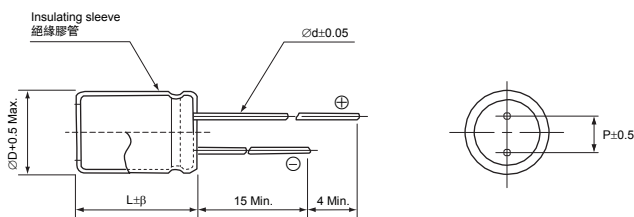

ØD	4	5	6.3
p	1.5	2.0	2.5
Ød	0.45		
β	1.0		

Note: All design and specifications are for reference only and is subject to change without prior notice. If any doubt about safety for your application, please contact us immediately for technical assistance before purchase.

注: 以上所提供的設計及特性參數僅供參考, 任何修改不作預先通知。如果在使用上有疑問, 請在採購前與我們聯繫, 以便提供技術上的協助。

CAT.2023/V2

LS Series

□ DIMENSIONS & MAXIMUM PERMISSIBLE RIPPLE CURRENT 規格尺寸及最大允許紋波電流

μF	WV Code 代碼	4		6.3		10		16		25		35		50	
		0G		0J		1A		1C		1E		1V		1H	
0.1	0R1													4 x 5	1
0.22	R22													4 x 5	2
0.33	R33													4 x 5	2.8
0.47	R47													4 x 5	4
0.68	R68													4 x 5	8.3
1	010													4 x 5	9
2.2	2R2													4 x 5	13
3.3	3R3													4 x 5	17
4.7	4R7											4 x 5	18	5 x 5	20
6.8	6R8									4 x 5	21	5 x 5	24	6.3 x 5	28
10	100							4 x 5	23	5 x 5	27	5 x 5	29	6.3 x 5	33
22	220			4 x 5	28	5 x 5	30	5 x 5	37	6.3 x 5	42	6.3 x 5	46		
33	330	5 x 5	25	5 x 5	35	5 x 5	41	6.3 x 5	49	6.3 x 5	52				
47	470	5 x 5	33	5 x 5	45	6.3 x 5	52	6.3 x 5	58						
68	680	6.3 x 5	45	6.3 x 5	55										
100	101	6.3 x 5	56	6.3 x 5	70									Case size 尺寸	Ripple current 紋波電流

•Case size $\varnothing D \times L$ (mm), ripple current (mA rms) at 105°C, 120Hz •尺寸 $\varnothing D \times L$ (mm), 紋波電流(mA rms)於 105°C, 120Hz

- Please refer to page 19 "Taping Specifications" & page 21 "Lead Forming & Cutting" about the taped or formed product spec. 編帶與引線成型標準請查閱第 19 頁 "編帶標準" 及第 21 頁 "引線成型與剪腳"。
- Please refer to page 20 "Packaging Specifications" for the minimum package quantity. 最小包裝數量請查閱第 20 頁 "包裝標準"。
- Please refer to page 16 for the Part Number System. 產品編碼規則請查閱第 16 頁。

Note: All design and specifications are for reference only and is subject to change without prior notice. If any doubt about safety for your application, please contact us immediately for technical assistance before purchase.

注：以上所提供的設計及特性參數僅供參考，任何修改不作預先通知。如果在使用上有疑問，請在採購前與我們聯繫，以便提供技術上的協助。

CAT.2023/V2

NP Series

NON-POLARIZED

無極性品

- Standard non-polarized series
無極性標準型系列
- Designed for use in circuits with reversing polarity
適用於極性變換電路
- Endurance 2000 hours at 85°C
在 85°C 環境中耐久性 2000 小時
- Comply with the RoHS & REACH
符合 RoHS 與 REACH

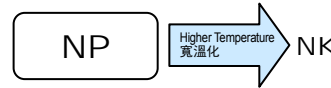
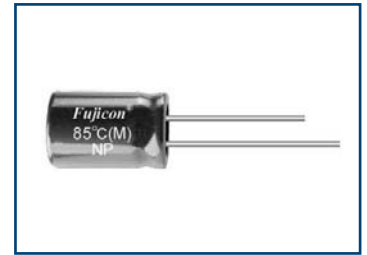

□ SPECIFICATIONS 特性表

Items 項目	Characteristics 主要特性																	
Category Temperature Range 工作溫度範圍	-40 ~ +85°C																	
Voltage Range 額定工作電壓範圍	6.3 ~ 250V																	
Capacitance Range 靜電容量範圍	0.47 ~ 10000μF																	
Capacitance Tolerance 靜電容量允許偏差	±20% at 120Hz, 20°C																	
Leakage Current 漏電流	Leakage current ≤0.03CV or 3μA, whichever is greater (after 5 minutes application of rated voltage at 20°C) 漏電流 ≤0.03CV 或 3μA, 取較大值 (在 20°C 環境中施加額定工作電壓 5 分鐘後) C: Nominal capacitance (μF) 標稱靜電容量, V: Rated voltage (V) 額定電壓																	
Dissipation Factor (tan δ) 損耗角正切	When nominal capacitance is over 1000μF, tan δ shall be added 0.02 to the listed value with increase of every 1000μF. 當標稱靜電容量大於 1000μF, 其標稱靜電容量每增加 1000μF, 損耗角正切增加 0.02。 Measurement frequency 測試頻率: 120Hz, Temperature 溫度: 20°C																	
Stability at Low Temperature 低溫特性	Measurement frequency 測試頻率: 120Hz																	
	<table border="1"> <thead> <tr> <th>Rated Voltage (V) 額定工作電壓</th> <th>6.3</th> <th>10</th> <th>16</th> <th>25</th> <th>35</th> <th>50~100</th> <th>160</th> <th>200~250</th> </tr> </thead> <tbody> <tr> <td>tan δ (max.) 最大損耗角正切</td> <td>0.25</td> <td>0.23</td> <td>0.20</td> <td>0.15</td> <td>0.15</td> <td>0.12</td> <td>0.15</td> <td>0.20</td> </tr> </tbody> </table>	Rated Voltage (V) 額定工作電壓	6.3	10	16	25	35	50~100	160	200~250	tan δ (max.) 最大損耗角正切	0.25	0.23	0.20	0.15	0.15	0.12	0.15
Rated Voltage (V) 額定工作電壓	6.3	10	16	25	35	50~100	160	200~250										
tan δ (max.) 最大損耗角正切	0.25	0.23	0.20	0.15	0.15	0.12	0.15	0.20										
Endurance 耐久性	After 2000 hours application of the rated voltage at 85°C, they meet the characteristics listed below. 在 85°C 環境中施加額定工作電壓 2000 小時後, 電容器的特性符合下表的要求。																	
	<table border="1"> <thead> <tr> <th>Capacitance Change 靜電容量變化率</th> <th>Within ±20% of initial measured value 初始值的±20%以內</th> </tr> </thead> <tbody> <tr> <td>Dissipation Factor 損耗角正切</td> <td>≤200% of initial specified value 不大於規範值的 200%</td> </tr> <tr> <td>Leakage Current 漏電流</td> <td>≤initial specified value 不大於規範值</td> </tr> </tbody> </table>	Capacitance Change 靜電容量變化率	Within ±20% of initial measured value 初始值的±20%以內	Dissipation Factor 損耗角正切	≤200% of initial specified value 不大於規範值的 200%	Leakage Current 漏電流	≤initial specified value 不大於規範值											
	Capacitance Change 靜電容量變化率	Within ±20% of initial measured value 初始值的±20%以內																
Dissipation Factor 損耗角正切	≤200% of initial specified value 不大於規範值的 200%																	
Leakage Current 漏電流	≤initial specified value 不大於規範值																	
Shelf Life 高溫貯存特性	After leaving capacitors under no load at 85°C for 1000 hours, they meet the specified value for load life characteristics listed above. 在 85°C 環境中無負荷放置 1000 小時後, 電容器的特性符合高溫負荷特性中所列的規定值。																	
Marking 標識	Printed with white colour on black sleeve (PVC) or printed with white colour on green sleeve (PET). 黑色膠管白字印刷 (PVC) 或綠色膠管白字印刷 (PET)。																	

□ DRAWING & DIMENSIONS 外形圖及尺寸 (Unit: mm)

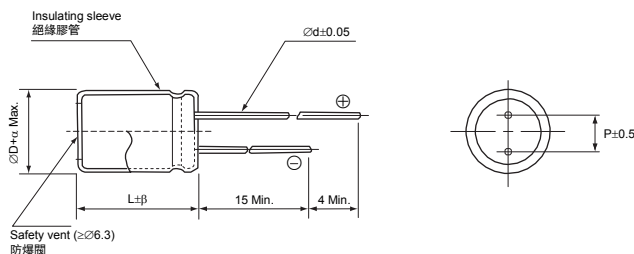

ØD	5	6.3	8 (L≤11.5)	8 (L≥16)	10	13	16	18	22	25
P	2.0	2.5	3.5	5.0	7.5	10.0	12.5			
Ød	0.5		0.6		0.8					
β	1.5					2.0				
α	0.5								1.0	

□ FREQUENCY COEFFICIENT OF ALLOWABLE RIPPLE CURRENT 紋波電流頻率補償係數

Frequency 頻率	50Hz	120Hz	300Hz	1kHz	10kHz~
Coefficient 係數	0.1 ~47μF	0.75	1.00	1.35	2.0
	68 ~680μF	0.80	1.00	1.25	1.5
	1000 ~10000μF	0.85	1.00	1.10	1.13

The endurance of capacitors is reduced with internal heating produced by ripple current at the rate of halving the lifetime with every 5~10°C rise. When long life performance is required in actual use, the rms ripple current has to be reduced. 鋁電解電容器在疊加紋波電流後會引起發熱, 溫度每上升 5~10°C 壽命會減半。若要保持長壽命性能, 請在使用過程中適當降低紋波電流。

Note: All design and specifications are for reference only and is subject to change without prior notice. If any doubt about safety for your application, please contact us immediately for technical assistance before purchase.

注: 以上所提供的設計及特性參數僅供參考, 任何修改不作預先通知。如果在使用上有疑問, 請在採購前與我們聯繫, 以便提供技術上的協助。

CAT.2023/V2

NP Series

□ DIMENSIONS & MAXIMUM PERMISSIBLE RIPPLE CURRENT 規格尺寸及最大允許紋波電流

μF	WV Code 代碼	6.3		10		16		25		35		50		63	
		0J		1A		1C		1E		1V		1H		1J	
0.47	R47											5 x 11	12	5 x 11	12
0.68	R68											5 x 11	14	5 x 11	14
1	010											5 x 11	18	5 x 11	18
1.5	1R5											5 x 11	21	5 x 11	21
2.2	2R2											5 x 11	26	5 x 11	26
3.3	3R3											5 x 11	32	5 x 11	32
4.7	4R7											5 x 11	38	5 x 11	38
6.8	6R8											5 x 11	46	5 x 11	46
10	100											5 x 11	55	6.3 x 11.5	64
15	150									5 x 11	61	6.3 x 11.5	78	6.3 x 11.5	78
22	220							5 x 11	73	6.3 x 11.5	84	6.3 x 11.5	94	8 x 11.5	111
33	330					5 x 11	78	6.3 x 11.5	103	6.3 x 11.5	103	8 x 11.5	136	10 x 12	158
47	470			5 x 11	87	5 x 11 (6.3 x 11.5)	92 (107)	6.3 x 11.5	123	8 x 11.5	145	10 x 12	189	10 x 16	207
68	680	5 x 11	100	6.3 x 11.5	120	6.3 x 11.5	129	8 x 11.5	175	10 x 12	203	10 x 16	249	10 x 20	272
100	101	6.3 x 11.5	139	6.3 x 11.5	145	8 x 11.5	184	10 x 12	247	10 x 16	270	10 x 20	329	10 x 20	329
150	151	6.3 x 11.5	171	8 x 11.5	210	10 x 12	262	10 x 12 (10 x 16)	300 (331)	10 x 20	361	10 x 20	404	13 x 21	474
220	221	8 x 11.5	244	10 x 12	295	10 x 16	347	10 x 12 (10 x 20)	310 (437)	10 x 20	437	13 x 21	574	13 x 25	625
330	331	10 x 12	347	10 x 16	396	10 x 20	464	10 x 20	535	13 x 21	628	16 x 25	850	16 x 25	850
470	471	10 x 16	454	10 x 20	516	10 x 20	553	13 x 21	750	13 x 21	818	16 x 31	1110	16 x 35	1164
680	681	10 x 20	595	13 x 21	729	13 x 21	781	13 x 25	984	16 x 25	1091	18 x 35	1503	18 x 40	1577
1000	102	13 x 21	847	13 x 21	883	13 x 25	1033	16 x 25	1323	16 x 35	1519	18 x 40	1912	22 x 40	2105
1500	152	13 x 21	999	13 x 25	1132	16 x 25	1338	16 x 35	1748	18 x 40	1968	22 x 40	2368	25 x 40	2607
2200	222	13 x 25	1272	16 x 25	1463	16 x 35	1781	18 x 40	2254	22 x 40	2481	25 x 50	3221		
3300	332	16 x 25	1672	16 x 35	1985	18 x 40	2890	22 x 40	2890	25 x 40	3157				
4700	472	16 x 35	2221	18 x 40	2579	22 x 40	2987	25 x 50	3927						
6800	682	18 x 40	2840	22 x 40	3214	25 x 50	4004								
10000	103	22 x 40	3516	25 x 50	4290										

μF	WV Code 代碼	100		160		200		250	
		2A		2C		2D		2E	
0.47	R47	5 x 11	12						
0.68	R68	5 x 11	14						
1	010	5 x 11	18						
1.5	1R5	5 x 11	21						
2.2	2R2	5 x 11	26						
3.3	3R3	5 x 11	32	8 x 11.5	49	8 x 11.5	42	10 x 12	46
4.7	4R7	6.3 x 11.5	44	8 x 11.5	59	10 x 12	55	10 x 12	65
6.8	6R8	8 x 11.5	62	10 x 20	77	13 x 21	78	13 x 21	78
10	100	8 x 11.5 (8 x 16)	75 (80)	13 x 21	109	13 x 21	95	13 x 25	103
15	150	10 x 12	107	13 x 21	134	13 x 25	127	16 x 25	140
22	220	10 x 12 (10 x 16)	130 (142)	13 x 25	177	16 x 25	170	16 x 31	186
33	330	10 x 20	189	16 x 25	240	16 x 35	239	18 x 35	256
47	470	13 x 21	265	16 x 35	329	18 x 40	321		
68	680	13 x 25	348	18 x 35	425				
100	101	16 x 25	468						
150	151	16 x 25	573						
220	221	16 x 35	797						
330	331	18 x 40	1098						
470	471	22 x 40	1443						
680	681	25 x 40	1896						
								Case size 尺寸	Ripple current 紋波電流

•Case size $\varnothing D \times L$ (mm), ripple current (mA rms) at 85°C, 120Hz •尺寸 $\varnothing D \times L$ (mm), 紋波電流(mA rms)於 85°C, 120Hz

- Please refer to page 19 "Taping Specifications" & page 21 "Lead Forming & Cutting" about the taped or formed product spec. 編帶與引線成型標準請查閱第 19 頁“編帶標準”及第 21 頁“引線成型與剪腳”。
- Please refer to page 20 "Packaging Specifications" for the minimum package quantity. 最小包裝數量請查閱第 20 頁“包裝標準”。
- Please refer to page 16 for the Part Number System. 產品編碼規則請查閱第 16 頁。

Note: All design and specifications are for reference only and is subject to change without prior notice. If any doubt about safety for your application, please contact us immediately for technical assistance before purchase.
 注：以上所提供的設計及特性參數僅供參考，任何修改不作預先通知。如果在使用上有疑問，請在採購前與我們聯繫，以便提供技術上的協助。

CAT.2023/V2

NK Series

NON-POLARIZED, WIDE TEMPERATURE RANGE

無極性寬溫品

- Wide operating temperature range of $-40\sim+105^{\circ}\text{C}$
適用於 $-40\sim+105^{\circ}\text{C}$ 的寬溫範圍
- Designed for use in circuits with reversing polarity
適用於極性變換電路
- Comply with the RoHS & REACH
符合 RoHS 與 REACH

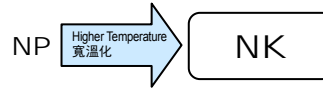

SPECIFICATIONS 特性表

Items 項目	Characteristics 主要特性						
Category Temperature Range 工作溫度範圍	$-40\sim+105^{\circ}\text{C}$						
Voltage Range 額定工作電壓範圍	6.3 ~ 100V						
Capacitance Range 靜電容量範圍	0.1 ~ 10000 μF						
Capacitance Tolerance 靜電容量允許偏差	$\pm 20\%$ at 120Hz, 20°C						
Leakage Current 漏電流	Leakage current $\leq 0.03\text{CV}$ or $3\mu\text{A}$, whichever is greater (after 5 minutes application of rated voltage at 20°C) 漏電流 $\leq 0.03\text{CV}$ 或 $3\mu\text{A}$, 取較大值 (在 20°C 環境中施加額定工作電壓 5 分鐘後) C: Nominal capacitance (μF) 標稱靜電容量, V: Rated voltage (V) 額定電壓						
Dissipation Factor (tan δ) 損耗角正切	When nominal capacitance is over 1000 μF , tan δ shall be added 0.02 to the listed value with increase of every 1000 μF . 當標稱靜電容量大於 1000 μF , 其標稱靜電容量每增加 1000 μF , 損耗角正切增加 0.02. Measurement frequency 測試頻率: 120Hz, Temperature 溫度: 20°C						
Stability at Low Temperature 低溫特性	Rated Voltage (V) 額定工作電壓	6.3	10	16	25	35	50~100
	tan δ (max.) 最大損耗角正切	0.24	0.20	0.16	0.16	0.14	0.12
Endurance 耐久性	Measurement frequency 測試頻率: 120Hz						
	Rated Voltage (V) 額定工作電壓	6.3	10	16	25	35	50~100
Shelf Life 高溫貯存特性	Impedance Ratio $Z(-25^{\circ}\text{C}) / Z(20^{\circ}\text{C})$ 阻抗比	4	3	2	2		
	$Z(-40^{\circ}\text{C}) / Z(20^{\circ}\text{C})$	8	6	4	3		
Marking 標識	Capacitance Change 靜電容量變化率	Within $\pm 20\%$ of initial measured value 初始值的 $\pm 20\%$ 以內					
	Dissipation Factor 損耗角正切	$\leq 200\%$ of initial specified value 不大於規範值的 200%					
	Leakage Current 漏電流	\leq initial specified value 不大於規範值					

DRAWING & DIMENSIONS 外形圖及尺寸 (Unit: mm)

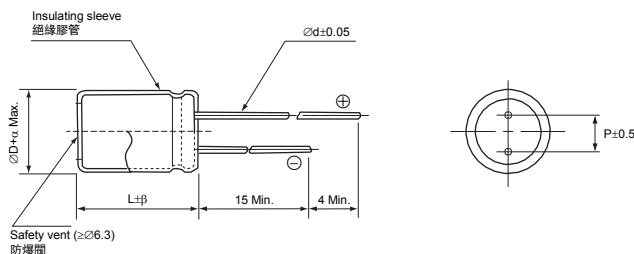

$\varnothing D$	5	6.3	8 (L ≤ 11.5)	8 (L ≥ 16)	10	13	16	18	22	25	
P	2.0	2.5	3.5		5.0	7.5		10.0	12.5		
$\varnothing d$	0.5			0.6		0.8					
β	1.5				2.0						
α	0.5								1.0		

FREQUENCY COEFFICIENT OF ALLOWABLE RIPPLE CURRENT 紋波電流頻率補償係數

Frequency 頻率		50Hz	120Hz	300Hz	1kHz	10kHz~
Coefficient 係數	0.1 ~ 47 μF	0.75	1.00	1.35	1.55	2.00
	68 ~ 680 μF	0.80	1.00	1.25	1.34	1.50
	1000 ~ 6800 μF	0.85	1.00	1.10	1.13	1.15

The endurance of capacitors is reduced with internal heating produced by ripple current at the rate of halving the lifetime with every $5\sim 10^{\circ}\text{C}$ rise. When long life performance is required in actual use, the rms ripple current has to be reduced. 鋁電解電容器在疊加紋波電流後會引起發熱，溫度每上升 $5\sim 10^{\circ}\text{C}$ 壽命會減半。若要保持長壽命性能，請在使用過程中適當降低紋波電流。

Note: All design and specifications are for reference only and is subject to change without prior notice. If any doubt about safety for your application, please contact us immediately for technical assistance before purchase.
注：以上所提供的設計及特性參數僅供參考，任何修改不作預先通知。如果在使用上有疑問，請在採購前與我們聯繫，以便提供技術上的協助。

CAT.2023/V2

NK Series

□ DIMENSIONS & MAXIMUM PERMISSIBLE RIPPLE CURRENT 規格尺寸及最大允許紋波電流

μF	WV Code 代碼	6.3		10		16		25		35		50		63		100		
		0J		1A		1C		1E		1V		1H		1J		2A		
0.1	0R1											5 x 11	3.6	5 x 11	3.9	5 x 11	4.2	
0.15	R15											5 x 11	4.4	5 x 11	4.8	5 x 11	5.1	
0.22	R22											5 x 11	5.3	5 x 11	5.8	5 x 11	6.2	
0.33	R33											5 x 11	6.5	5 x 11	7.2	5 x 11	7.5	
0.47	R47											5 x 11	7.8	5 x 11	8.5	5 x 11	9.2	
0.68	R68											5 x 11	9.4	5 x 11	10	5 x 11	11	
1	010											5 x 11	11	5 x 11	12	5 x 11	13	
1.5	1R5											5 x 11	14	5 x 11	15	5 x 11	16	
2.2	2R2											5 x 11	17	5 x 11	18	5 x 11	19	
3.3	3R3											5 x 11	21	5 x 11	23	6.3 x 11.5	27	
4.7	4R7									5 x 11	23	5 x 11	25	6.3 x 11.5	31	8 x 11.5	39	
6.8	6R8							5 x 11	26	5 x 11	27	6.3 x 11.5	34	6.3 x 11.5	37	10 x 12	54	
10	100					5 x 11	31	5 x 11	31	6.3 x 11.5	38	6.3 x 11.5	41	6.3 x 11.5	53	10 x 12	65	
15	150			5 x 11	34	5 x 11	38	6.3 x 11.5	44	8 x 11.5	55	8 x 11.5	60	10 x 12	76	10 x 16	88	
22	220	5 x 11	38	5 x 11	41	6.3 x 11.5	53	8 x 11.5	63	8 x 11.5	67	8 x 11.5	84	10 x 16	101			
33	330	5 x 11	46	6.3 x 11.5	58	8 x 11.5	77	8 x 11.5	77	10 x 12	95	10 x 16	113	10 x 16	124			
47	470	6.3 x 11.5	63	6.3 x 11.5	69	8 x 11.5	92	10 x 12	106	10 x 16	125	10 x 20	147	10 x 20	161			
68	680	6.3 x 11.5	76	8 x 11.5	98	10 x 12	128	10 x 16	140	10 x 20	164	10 x 20	177	13 x 21	227			
100	101	8 x 11.5	109	10 x 12	139	10 x 16	170	10 x 20	185	10 x 20	198	13 x 21	251	13 x 25	300			
150	151	10 x 12	155	10 x 16	186	10 x 20	227	13 x 21	267	13 x 21	285	13 x 25	336	16 x 25	408			
220	221	10 x 12	188	10 x 20	246	13 x 21	323	13 x 21	323	13 x 25	376	16 x 25	451	16 x 35	567			
330	331	10 x 16	252	13 x 21	354	13 x 21	396	13 x 25	431	16 x 25	511	16 x 35	634	18 x 35	745			
470	471	10 x 20	328	13 x 21	422	13 x 25	515	16 x 25	571	16 x 35	701	18 x 35	812	18 x 40	933			
680	681	13 x 21	464	13 x 25	554	16 x 25	687	16 x 35	788	18 x 35	904	18 x 40	1025	22 x 40	1236			
1000	102	13 x 25	613	16 x 25	745	16 x 35	956	18 x 35	1026	18 x 40	1151	22 x 40	1368	25 x 40	1637			
1500	152	16 x 25	800	16 x 35	999	18 x 35	1184	18 x 40	1243	22 x 40	1451	25 x 40	1694					
2200	222	16 x 35	1072	18 x 35	1242	18 x 40	1428	22 x 40	1572	25 x 50	1974							
3300	332	18 x 35	1361	18 x 40	1534	22 x 40	1835	25 x 40	2005									
4700	472	18 x 40	1650	22 x 40	1942	25 x 50	2498											
6800	682	18 x 35	2060	25 x 50	2603													
10000	103	25 x 50	2755														Case size 尺寸	Ripple current 紋波電流

•Case size $\varnothing D \times L$ (mm), ripple current (mA rms) at 105°C, 120Hz •尺寸 $\varnothing D \times L$ (mm), 紋波電流(mA rms)於 105°C, 120Hz

- Please refer to page 19 "Taping Specifications" & page 21 "Lead Forming & Cutting" about the taped or formed product spec. 編帶與引線成型標準請查閱第 19 頁 "編帶標準" 及第 21 頁 "引線成型與剪腳"。
- Please refer to page 20 "Packaging Specifications" for the minimum package quantity. 最小包裝數量請查閱第 20 頁 "包裝標準"。
- Please refer to page 16 for the Part Number System. 產品編碼規則請查閱第 16 頁。

Note: All design and specifications are for reference only and is subject to change without prior notice. If any doubt about safety for your application, please contact us immediately for technical assistance before purchase.

注：以上所提供的設計及特性參數僅供參考，任何修改不作預先通知。如果在使用上有疑問，請在採購前與我們聯繫，以便提供技術上的協助。

CAT.2023/V2

NM Series

NON-POLARIZED, HEIGHT 7MM

7MM 高，無極性品

- Non-polarized series with 7mm height
7mm 高，無極性品系列
- Endurance 1000 hours
耐久性 1000 小時
- Comply with the RoHS & REACH
符合 RoHS 與 REACH

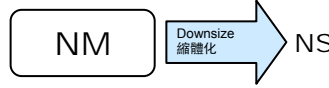
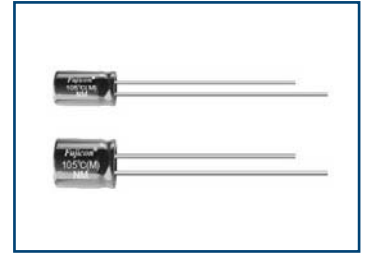

□ SPECIFICATIONS 特性表

Items 項目	Characteristics 主要特性														
Category Temperature Range 工作溫度範圍	-40 ~ +105°C														
Voltage Range 額定工作電壓範圍	6.3 ~ 63V														
Capacitance Range 靜電容量範圍	0.1 ~ 220μF														
Capacitance Tolerance 靜電容量允許偏差	±20% at 120Hz, 20°C														
Leakage Current 漏電流	Leakage current ≤0.05CV or 10μA, whichever is greater (after 5 minutes application of rated voltage at 20°C) 漏電流 ≤0.05CV 或 10μA, 取較大值 (在 20°C 環境中施加額定工作電壓 5 分鐘後) C: Nominal capacitance (μF) 標稱靜電容量, V: Rated voltage (V) 額定電壓														
Dissipation Factor (tan δ) 損耗角正切	Measurement frequency 測試頻率: 120Hz, Temperature 溫度: 20°C <table border="1"> <thead> <tr> <th>Rated Voltage (V) 額定工作電壓</th> <th>6.3</th> <th>10</th> <th>16</th> <th>25</th> <th>35</th> <th>50, 63</th> </tr> </thead> <tbody> <tr> <td>tan δ (max.) 最大損耗角正切</td> <td>0.24</td> <td>0.20</td> <td>0.16</td> <td>0.14</td> <td>0.12</td> <td>0.10</td> </tr> </tbody> </table>	Rated Voltage (V) 額定工作電壓	6.3	10	16	25	35	50, 63	tan δ (max.) 最大損耗角正切	0.24	0.20	0.16	0.14	0.12	0.10
Rated Voltage (V) 額定工作電壓	6.3	10	16	25	35	50, 63									
tan δ (max.) 最大損耗角正切	0.24	0.20	0.16	0.14	0.12	0.10									
Stability at Low Temperature 低溫特性	Measurement frequency 測試頻率: 120Hz <table border="1"> <thead> <tr> <th>Rated Voltage (V) 額定工作電壓</th> <th>6.3</th> <th>10</th> <th>16-63</th> </tr> </thead> <tbody> <tr> <td>Impedance Ratio 阻抗比</td> <td>Z(-25°C) / Z(20°C)</td> <td>4</td> <td>3</td> <td>2</td> </tr> <tr> <td></td> <td>Z(-40°C) / Z(20°C)</td> <td>8</td> <td>6</td> <td>4</td> </tr> </tbody> </table>	Rated Voltage (V) 額定工作電壓	6.3	10	16-63	Impedance Ratio 阻抗比	Z(-25°C) / Z(20°C)	4	3	2		Z(-40°C) / Z(20°C)	8	6	4
Rated Voltage (V) 額定工作電壓	6.3	10	16-63												
Impedance Ratio 阻抗比	Z(-25°C) / Z(20°C)	4	3	2											
	Z(-40°C) / Z(20°C)	8	6	4											
Endurance 耐久性	After 1000 hours application of the rated voltage at 105°C, they meet the characteristics listed below. 在 105°C 環境中施加額定工作電壓 1000 小時後，電容器的特性符合下表的要求。 <table border="1"> <tbody> <tr> <td>Capacitance Change 靜電容量變化率</td> <td>Within ±20% of initial measured value 初始值的±20%以內</td> </tr> <tr> <td>Dissipation Factor 損耗角正切</td> <td>≤200% of initial specified value 不大於規範值的 200%</td> </tr> <tr> <td>Leakage Current 漏電流</td> <td>≤initial specified value 不大於規範值</td> </tr> </tbody> </table>	Capacitance Change 靜電容量變化率	Within ±20% of initial measured value 初始值的±20%以內	Dissipation Factor 損耗角正切	≤200% of initial specified value 不大於規範值的 200%	Leakage Current 漏電流	≤initial specified value 不大於規範值								
Capacitance Change 靜電容量變化率	Within ±20% of initial measured value 初始值的±20%以內														
Dissipation Factor 損耗角正切	≤200% of initial specified value 不大於規範值的 200%														
Leakage Current 漏電流	≤initial specified value 不大於規範值														
Shelf Life 高溫貯存特性	After leaving capacitors under no load at 105°C for 500 hours, they meet the specified value for load life characteristics listed above. 在 105°C 環境中無負荷放置 500 小時後，電容器的特性符合高溫負荷特性中所列的規定值。														
Marking 標識	Printed with white colour on black sleeve (PVC) or printed with white colour on green sleeve (PET). 黑色膠管白字印刷 (PVC) 或綠色膠管白字印刷 (PET)。														

□ DRAWING & DIMENSIONS 外形圖及尺寸 (Unit: mm)

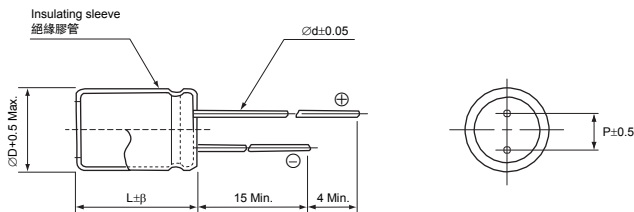

ØD	4	5	6.3
p	1.5	2.0	2.5
Ød	0.45		
β	1.0		

Note: All design and specifications are for reference only and is subject to change without prior notice. If any doubt about safety for your application, please contact us immediately for technical assistance before purchase.

注：以上所提供的設計及特性參數僅供參考，任何修改不作預先通知。如果在使用上有疑問，請在採購前與我們聯繫，以便提供技術上的協助。

CAT.2023/V2

NM Series

□ DIMENSIONS & MAXIMUM PERMISSIBLE RIPPLE CURRENT 規格尺寸及最大允許紋波電流

μF	WV Code 代碼	6.3		10		16		25		35		50		63	
		0J		1A		1C		1E		1V		1H		1J	
0.1	0R1											4 x 7	1	4 x 7	2.4
0.22	R22											4 x 7	2	4 x 7	3.2
0.33	R33											4 x 7	3.5	4 x 7	4
0.47	R47											4 x 7	5	4 x 7	6
0.68	R68											4 x 7	7	4 x 7	9
1	010											4 x 7	10	4 x 7	16
2.2	2R2											4 x 7	15	4 x 7	18
3.3	3R3									4 x 7	16	4 x 7	18	5 x 7	20
4.7	4R7									4 x 7	18	5 x 7	22	6.3 x 7	26
6.8	6R8							4 x 7	18	5 x 7	22	5 x 7	28	6.3 x 7	32
10	100	4 x 7	16	4 x 7	18	4 x 7	20	5 x 7	28	5 x 7	32	6.3 x 7	36	8 x 7	42
22	220	4 x 7	20	4 x 7	32	5 x 7	36	6.3 x 7	44	6.3 x 7	48	8 x 7	53		
33	330	4 x 7	26	5 x 7	36	5 x 7	42	6.3 x 7	52	8 x 7	67				
47	470	5 x 7	45	5 x 7	60	6.3 x 7	78	8 x 7	85						
68	680	6.3 x 7	45	6.3 x 7	78	6.3 x 7	82	8 x 7	95						
100	101	6.3 x 7	76	8 x 7	102	8 x 7	105								
220	221	8 x 7	115												Case size 尺寸
															Ripple current 紋波電流

•Case size ØD×L(mm), ripple current (mA rms) at 105°C, 120Hz •尺寸ØD×L(mm), 紋波電流(mA rms)於 105°C, 120Hz

- Please refer to page 19 "Taping Specifications" & page 21 "Lead Forming & Cutting" about the taped or formed product spec. 編帶與引線成型標準請查閱第 19 頁 "編帶標準" 及第 21 頁 "引線成型與剪腳"。
- Please refer to page 20 "Packaging Specifications" for the minimum package quantity. 最小包裝數量請查閱第 20 頁 "包裝標準"。
- Please refer to page 16 for the Part Number System. 產品編碼規則請查閱第 16 頁。

Note: All design and specifications are for reference only and is subject to change without prior notice. If any doubt about safety for your application, please contact us immediately for technical assistance before purchase.

注：以上所提供的設計及特性參數僅供參考，任何修改不作預先通知。如果在使用上有疑問，請在採購前與我們聯繫，以便提供技術上的協助。

CAT.2023/V2

NS Series

NON-POLARIZED, HEIGHT 5MM

5MM 高，無極性品

- Non-polarized series with 5mm height
5mm 高，無極性品系列
- Uniquely designed for use in lightweight and portable equipment
適用於小型及便攜器材
- Endurance 1000 hours
耐久性 1000 小時
- Comply with the RoHS & REACH
符合 RoHS 與 REACH

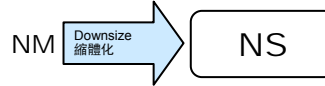

□ SPECIFICATIONS 特性表

Items 項目	Characteristics 主要特性															
Category Temperature Range 工作溫度範圍	-40 ~ +105°C															
Voltage Range 額定工作電壓範圍	6.3 ~ 50V															
Capacitance Range 靜電容量範圍	0.1 ~ 47μF															
Capacitance Tolerance 靜電容量允許偏差	±20% at 120Hz, 20°C															
Leakage Current 漏電流	Leakage current ≤0.05CV or 10μA, whichever is greater (after 5 minutes application of rated voltage at 20°C) 漏電流 ≤0.05CV 或 10μA, 取較大值 (在 20°C 環境中施加額定工作電壓 5 分鐘後) C: Nominal capacitance (μF) 標稱靜電容量, V: Rated voltage (V) 額定電壓															
Dissipation Factor (tan δ) 損耗角正切	Measurement frequency 測試頻率: 120Hz, Temperature 溫度: 20°C <table border="1"> <thead> <tr> <th>Rated Voltage (V) 額定工作電壓</th> <th>6.3</th> <th>10</th> <th>16</th> <th>25</th> <th>35</th> <th>50</th> </tr> </thead> <tbody> <tr> <td>tan δ (max.) 最大損耗角正切</td> <td>0.24</td> <td>0.20</td> <td>0.17</td> <td>0.17</td> <td>0.15</td> <td>0.15</td> </tr> </tbody> </table>	Rated Voltage (V) 額定工作電壓	6.3	10	16	25	35	50	tan δ (max.) 最大損耗角正切	0.24	0.20	0.17	0.17	0.15	0.15	
Rated Voltage (V) 額定工作電壓	6.3	10	16	25	35	50										
tan δ (max.) 最大損耗角正切	0.24	0.20	0.17	0.17	0.15	0.15										
Stability at Low Temperature 低溫特性	Measurement frequency 測試頻率: 120Hz <table border="1"> <thead> <tr> <th>Rated Voltage (V) 額定工作電壓</th> <th>6.3</th> <th>10</th> <th>16, 25</th> <th>35-50</th> </tr> </thead> <tbody> <tr> <td>Impedance Ratio 阻抗比</td> <td>Z(-25°C) / Z(20°C)</td> <td>4</td> <td>3</td> <td>2</td> </tr> <tr> <td></td> <td>Z(-40°C) / Z(20°C)</td> <td>8</td> <td>6</td> <td>4</td> </tr> </tbody> </table>	Rated Voltage (V) 額定工作電壓	6.3	10	16, 25	35-50	Impedance Ratio 阻抗比	Z(-25°C) / Z(20°C)	4	3	2		Z(-40°C) / Z(20°C)	8	6	4
Rated Voltage (V) 額定工作電壓	6.3	10	16, 25	35-50												
Impedance Ratio 阻抗比	Z(-25°C) / Z(20°C)	4	3	2												
	Z(-40°C) / Z(20°C)	8	6	4												
Endurance 耐久性	After 1000 hours application of the rated voltage at 105°C, they meet the characteristics listed below. 在 105°C 環境中施加額定工作電壓 1000 小時後，電容器的特性符合下表的要求。 <table border="1"> <thead> <tr> <th>Capacitance Change 靜電容量變化率</th> <th>Within ±20% of initial measured value 初始值的±20%以內</th> </tr> </thead> <tbody> <tr> <td>Dissipation Factor 損耗角正切</td> <td>≤200% of initial specified value 不大於規範值的 200%</td> </tr> <tr> <td>Leakage Current 漏電流</td> <td>≤initial specified value 不大於規範值</td> </tr> </tbody> </table>	Capacitance Change 靜電容量變化率	Within ±20% of initial measured value 初始值的±20%以內	Dissipation Factor 損耗角正切	≤200% of initial specified value 不大於規範值的 200%	Leakage Current 漏電流	≤initial specified value 不大於規範值									
Capacitance Change 靜電容量變化率	Within ±20% of initial measured value 初始值的±20%以內															
Dissipation Factor 損耗角正切	≤200% of initial specified value 不大於規範值的 200%															
Leakage Current 漏電流	≤initial specified value 不大於規範值															
Shelf Life 高溫貯存特性	After leaving capacitors under no load at 105°C for 500 hours, they meet the specified value for load life characteristics listed above. 在 105°C 環境中無負荷放置 500 小時後，電容器的特性符合高溫負荷特性中所列的規定值。															
Marking 標識	Printed with white colour on black sleeve (PVC) or printed with white colour on green sleeve (PET). 黑色膠管白字印刷 (PVC) 或綠色膠管白字印刷 (PET)。															

□ DRAWING & DIMENSIONS 外形圖及尺寸 (Unit: mm)

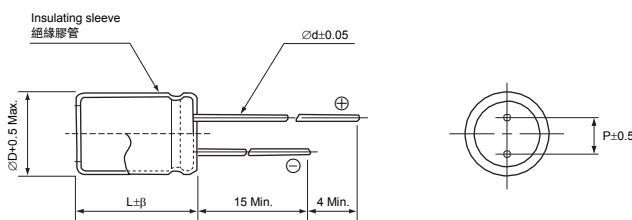

ØD	4	5	6.3
p	1.5	2.0	2.5
Ød	0.45		
β	1.0		

Note: All design and specifications are for reference only and is subject to change without prior notice. If any doubt about safety for your application, please contact us immediately for technical assistance before purchase.

注：以上所提供的設計及特性參數僅供參考，任何修改不作預先通知。如果在使用上有疑問，請在採購前與我們聯繫，以便提供技術上的協助。

CAT.2023/V2

NS Series

□ DIMENSIONS & MAXIMUM PERMISSIBLE RIPPLE CURRENT 規格尺寸及最大允許紋波電流

μF	WV Code 代碼	6.3		10		16		25		35		50	
		0J		1A		1C		1E		1V		1H	
0.1	0R1											4 x 5	3.2
0.22	R22											4 x 5	4.7
0.33	R33											4 x 5	5.8
0.47	R47											4 x 5	6.9
0.68	R68											4 x 5	8.3
1	010											4 x 5	10
2.2	2R2							4 x 5	10	4 x 5	11	5 x 5	12
3.3	3R3							4 x 5	14	4 x 5	16	5 x 5	21
4.7	4R7					4 x 5	12	4 x 5	16	4 x 5	18	6.3 x 5	24
6.8	6R8					4 x 5	18	5 x 5	20	5 x 5	24	6.3 x 5	32
10	100	4 x 5	14	4 x 5	18	4 x 5	20	5 x 5	21	6.3 x 5	28		
22	220	5 x 5	25	5 x 5	30	5 x 5	32	6.3 x 5	34				
33	330	5 x 5	35	6.3 x 5	37	6.3 x 5	42						
47	470	6.3 x 5	40									Case size 尺寸	Ripple current 紋波電流

•Case size $\varnothing D \times L$ (mm), ripple current (mA rms) at 105°C, 120Hz •尺寸 $\varnothing D \times L$ (mm), 紋波電流(mA rms)於 105°C, 120Hz

- Please refer to page 19 "Taping Specifications" & page 21 "Lead Forming & Cutting" about the taped or formed product spec. 編帶與引線成型標準請查閱第 19 頁“編帶標準”及第 21 頁“引線成型與剪腳”。
- Please refer to page 20 "Packaging Specifications" for the minimum package quantity. 最小包裝數量請查閱第 20 頁“包裝標準”。
- Please refer to page 16 for the Part Number System. 產品編碼規則請查閱第 16 頁。

Note: All design and specifications are for reference only and is subject to change without prior notice. If any doubt about safety for your application, please contact us immediately for technical assistance before purchase.

注：以上所提供的設計及特性參數僅供參考，任何修改不作預先通知。如果在使用上有疑問，請在採購前與我們聯繫，以便提供技術上的協助。

CAT.2023/V2

BP Series

BI-POLARIZED, HIGH RIPPLE CURRENT

雙極性，高紋波電流品

- High frequency and high ripple current characteristics
高頻及高紋波電流特性
- Suitable for horizontal deflection circuit
適用於水平偏轉電路
- Comply with the RoHS & REACH
符合 RoHS 與 REACH

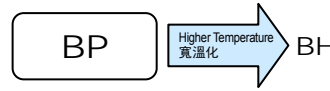

SPECIFICATIONS 特性表

Items 項目	Characteristics 主要特性						
Category Temperature Range 工作溫度範圍	-40 ~ +85°C						
Voltage Range 額定工作電壓範圍	25 & 50V						
Capacitance Range 靜電容量範圍	2.2 ~ 10μF						
Capacitance Tolerance 靜電容量允許偏差	±10% at 120Hz, 20°C						
Leakage Current 漏電流	Leakage current ≤0.03CV+50μA (Max.) (after 5 minutes application of rated voltage at 20°C) 漏電流 ≤0.03CV+50μA (Max.) (在 20°C 環境中施加額定工作電壓 5 分鐘後) C: Nominal capacitance (μF) 標稱靜電容量, V: Rated voltage (V) 額定電壓						
Dissipation Factor (tan δ) 損耗角正切	(Measurement frequency 測試頻率: 120Hz, Temperature 溫度: 20°C) Less than 0.05 不大於 0.05						
Stability at Low Temperature 低溫特性	Measurement frequency 測試頻率: 120Hz <table border="1"> <tr> <td>Impedance Ratio 阻抗比</td> <td>Z(-25°C) / Z(20°C)</td> <td>1.5</td> </tr> <tr> <td></td> <td>Z(-40°C) / Z(20°C)</td> <td>3.0</td> </tr> </table>	Impedance Ratio 阻抗比	Z(-25°C) / Z(20°C)	1.5		Z(-40°C) / Z(20°C)	3.0
Impedance Ratio 阻抗比	Z(-25°C) / Z(20°C)	1.5					
	Z(-40°C) / Z(20°C)	3.0					
Endurance 耐久性	After 1000 hours application of the rated voltage at 85°C (the polarity needs to exchange every 250 hours), they meet the characteristics listed below. 在 85°C 環境中施加額定工作電壓 1000 小時 (每 250 小時必須轉換一次極性) 後，電容器的特性符合下表的要求。 <table border="1"> <tr> <td>Capacitance Change 靜電容量變化率</td> <td>Within ±15% of initial measured value 初始值的±15%以內</td> </tr> <tr> <td>Dissipation Factor 損耗角正切</td> <td>≤200% of initial specified value 不大於規範值的 200%</td> </tr> <tr> <td>Leakage Current 漏電流</td> <td>≤initial specified value 不大於規範值</td> </tr> </table>	Capacitance Change 靜電容量變化率	Within ±15% of initial measured value 初始值的±15%以內	Dissipation Factor 損耗角正切	≤200% of initial specified value 不大於規範值的 200%	Leakage Current 漏電流	≤initial specified value 不大於規範值
Capacitance Change 靜電容量變化率	Within ±15% of initial measured value 初始值的±15%以內						
Dissipation Factor 損耗角正切	≤200% of initial specified value 不大於規範值的 200%						
Leakage Current 漏電流	≤initial specified value 不大於規範值						
Shelf Life 高溫貯存特性	After leaving capacitors under no load at 85°C for 500 hours, they meet the specified value for load life characteristics listed above. 在 85°C 環境中無負荷放置 500 小時後，電容器的特性符合高溫負荷特性中所列的規定值。						
Marking 標識	Printed with white colour on black sleeve (PVC) or printed with white colour on green sleeve (PET). 黑色膠管白字印刷 (PVC) 或綠色膠管白字印刷 (PET)。						

DRAWING & DIMENSIONS 外形圖及尺寸 (Unit: mm)

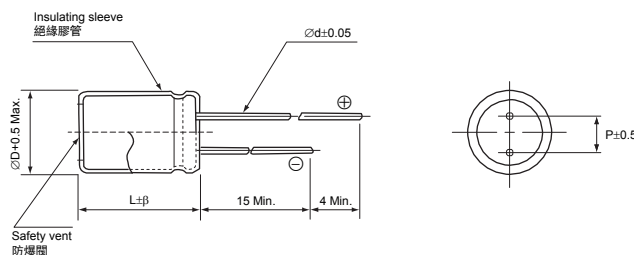

ØD	13	16	18
P	5.0	7.5	
Ød	0.6	0.8	
β	2.0		

DIMENSIONS & MAXIMUM PERMISSIBLE RIPPLE CURRENT 規格尺寸及最大允許紋波電流

WV Parameter Code 參數 代碼 μF	25 (1E)		50 (1H)		
	Case size ØD×L (mm) 尺寸	Ripple current (Ap-p) at 85°C, 15.75KHz 紋波電流	Case size ØD×L (mm) 尺寸	Ripple current (Ap-p) at 85°C, 15.75KHz 紋波電流	
2.2	2R2	13 × 25	5.0	13 × 25	5.0
3.3	3R3	16 × 25	6.0	16 × 25	6.0
4.7	4R7	16 × 32	7.0	16 × 32	7.0
5.6	5R6	16 × 32	7.5	16 × 32	7.5
6.8	6R8	16 × 35	8.0	16 × 35	8.0
8.2	8R2	16 × 35	9.0	16 × 35	9.0
10	100	18 × 35	10.0	18 × 35	10.0

- Please refer to page 19 "Taping Specifications" & page 21 "Lead Forming & Cutting" about the taped or formed product spec. 編帶與引線成型標準請查閱第 19 頁 "編帶標準" 及第 21 頁 "引線成型與剪腳"。
- Please refer to page 20 "Packaging Specifications" for the minimum package quantity. 最小包裝數量請查閱第 20 頁 "包裝標準"。
- Please refer to page 16 for the Part Number System. 產品編碼規則請查閱第 16 頁。

Note: All design and specifications are for reference only and is subject to change without prior notice. If any doubt about safety for your application, please contact us immediately for technical assistance before purchase.
注：以上所提供的設計及特性參數僅供參考，任何修改不作預先通知。如果在使用上有疑問，請在採購前與我們聯繫，以便提供技術上的協助。

CAT.2023/V2

BH Series

BI-POLARIZED, HIGH RIPPLE CURRENT

雙極性，高紋波電流品

- High frequency and high ripple current characteristics
高頻及高紋波電流特性
- Suitable for horizontal deflection circuit
適用於水平偏轉電路
- Comply with the RoHS & REACH
符合 RoHS 與 REACH

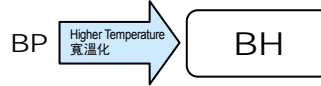

SPECIFICATIONS 特性表

Items 項目	Characteristics 主要特性						
Category Temperature Range 工作溫度範圍	-40 ~ +105°C						
Voltage Range 額定工作電壓範圍	25 & 50V						
Capacitance Range 靜電容量範圍	2.2 ~ 10μF						
Capacitance Tolerance 靜電容量允許偏差	±10% at 120Hz, 20°C						
Leakage Current 漏電流	Leakage current ≤0.03CV+50μA (Max.) (after 5 minutes application of rated voltage at 20°C) 漏電流 ≤0.03CV+50μA (Max.) (在 20°C 環境中施加額定工作電壓 5 分鐘後) C: Nominal capacitance (μF) 標稱靜電容量, V: Rated voltage (V) 額定電壓						
Dissipation Factor (tan δ) 損耗角正切	(Measurement frequency 測試頻率: 120Hz, Temperature 溫度: 20°C) Less than 0.05 不大於 0.05						
Stability at Low Temperature 低溫特性	Measurement frequency 測試頻率: 120Hz <table border="1"> <tr> <td rowspan="2">Impedance Ratio 阻抗比</td> <td>Z(-25°C) / Z(20°C)</td> <td>1.5</td> </tr> <tr> <td>Z(-40°C) / Z(20°C)</td> <td>3.0</td> </tr> </table>	Impedance Ratio 阻抗比	Z(-25°C) / Z(20°C)	1.5	Z(-40°C) / Z(20°C)	3.0	
Impedance Ratio 阻抗比	Z(-25°C) / Z(20°C)		1.5				
	Z(-40°C) / Z(20°C)	3.0					
Endurance 耐久性	After 1000 hours application of the rated voltage at 105°C (the polarity needs to exchange every 250 hours), they meet the characteristics listed below. 在 105°C 環境中施加額定工作電壓 1000 小時 (每 250 小時必須轉換一次極性) 後，電容器的特性符合下表的要求。 <table border="1"> <tr> <td>Capacitance Change 靜電容量變化率</td> <td>Within ±15% of initial measured value 初始值的±15%以內</td> </tr> <tr> <td>Dissipation Factor 損耗角正切</td> <td>≤200% of initial specified value 不大於規範值的 200%</td> </tr> <tr> <td>Leakage Current 漏電流</td> <td>≤initial specified value 不大於規範值</td> </tr> </table>	Capacitance Change 靜電容量變化率	Within ±15% of initial measured value 初始值的±15%以內	Dissipation Factor 損耗角正切	≤200% of initial specified value 不大於規範值的 200%	Leakage Current 漏電流	≤initial specified value 不大於規範值
Capacitance Change 靜電容量變化率	Within ±15% of initial measured value 初始值的±15%以內						
Dissipation Factor 損耗角正切	≤200% of initial specified value 不大於規範值的 200%						
Leakage Current 漏電流	≤initial specified value 不大於規範值						
Shelf Life 高溫貯存特性	After leaving capacitors under no load at 105°C for 500 hours, they meet the specified value for load life characteristics listed above. 在 105°C 環境中無負荷放置 500 小時後，電容器的特性符合高溫負荷特性中所列的規定值。						
Marking 標識	Printed with white colour on black sleeve (PVC) or printed with white colour on green sleeve (PET). 黑色膠管白字印刷 (PVC) 或綠色膠管白字印刷 (PET)。						

DRAWING & DIMENSIONS 外形圖及尺寸 (Unit: mm)

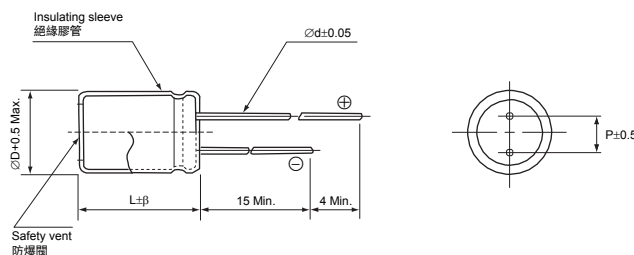

ØD	13	16	18
P	5.0	7.5	
Ød	0.6	0.8	
β	2.0		

DIMENSIONS & MAXIMUM PERMISSIBLE RIPPLE CURRENT 規格尺寸及最大允許紋波電流

WV Parameter Code 參數 代碼 μF	25 (1E)		50 (1H)		
	Case size ØD×L (mm) 尺寸	Ripple current (Ap-p) at 105°C, 15.75KHz 紋波電流	Case size ØD×L (mm) 尺寸	Ripple current (Ap-p) at 105°C, 15.75KHz 紋波電流	
2.2	2R2	13 × 25	3.0	13 × 25	3.0
3.3	3R3	16 × 25	3.6	16 × 25	3.6
4.7	4R7	16 × 32	4.2	16 × 32	4.2
5.6	5R6	16 × 32	4.5	16 × 32	4.5
6.8	6R8	16 × 35	4.8	16 × 35	4.8
8.2	8R2	16 × 35	5.0	16 × 35	5.0
10	100	18 × 35	6.0	18 × 35	6.0

- Please refer to page 19 "Taping Specifications" & page 21 "Lead Forming & Cutting" about the taped or formed product spec. 編帶與引線成型標準請查閱第 19 頁 "編帶標準" 及第 21 頁 "引線成型與剪腳"。
- Please refer to page 20 "Packaging Specifications" for the minimum package quantity. 最小包裝數量請查閱第 20 頁 "包裝標準"。
- Please refer to page 16 for the Part Number System. 產品編碼規則請查閱第 16 頁。

Note: All design and specifications are for reference only and is subject to change without prior notice. If any doubt about safety for your application, please contact us immediately for technical assistance before purchase.
注：以上所提供的設計及特性參數僅供參考，任何修改不作預先通知。如果在使用上有疑問，請在採購前與我們聯繫，以便提供技術上的協助。

CAT.2023/V2

TM Series

LOW IMPEDANCE

低阻抗品

- Low impedance at high frequency
高頻低阻抗
- Ideally suited for use of switching power supplies
適用於開關電源
- Endurance 2000~3000 hours
壽命持久性 2000~3000 小時
- Comply with the RoHS & REACH
符合 RoHS 與 REACH

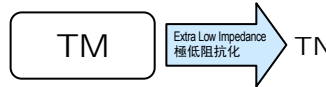
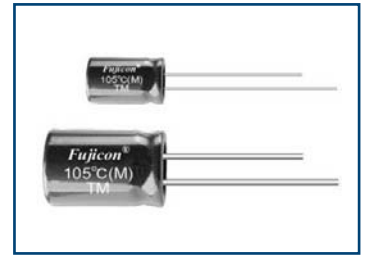

SPECIFICATIONS 特性表

Items 項目	Characteristics 主要特性	
Category Temperature Range 工作溫度範圍	-40 ~ +105°C	-25 ~ +105°C
Voltage Range 額定工作電壓範圍	6.3 ~ 100V	160 ~ 450V
Capacitance Range 靜電容量範圍	1 ~ 15000µF	22 ~ 330µF
Capacitance Tolerance 靜電容量允許偏差	±20% at 120Hz, 20°C	
Leakage Current 漏電流	Leakage current ≤0.01CV or 3µA, whichever is greater (after 2 minutes application of rated voltage at 20°C) 漏電流 ≤0.01CV 或 3µA 取較大值(在 20°C 環境中施加額定工作電壓 2 分鐘後)	Leakage current ≤0.02CV + 15µA (after 5 minutes application of rated voltage at 20°C) 漏電流 ≤0.02CV + 15µA(在 20°C 環境中施加額定工作電壓 5 分鐘後)
Dissipation Factor (tan δ) 損耗角正切	C: Nominal capacitance (µF) 標稱靜電容量, V: Rated voltage (V) 額定電壓	
	When nominal capacitance is over 1000µF, tan δ shall be added 0.02 to the listed value with increase of every 1000µF. 當標稱靜電容量大於 1000µF, 其標稱靜電容量每增加 1000µF, 損耗角正切增加 0.02。 Measurement frequency 測試頻率: 120Hz, Temperature 溫度: 20°C	
	Rated Voltage (V) 額定工作電壓	6.3 10 16~35 50, 63 100 160~250 350~450
Stability at Low Temperature 低溫特性	Measurement frequency 測試頻率: 120Hz	
	Rated Voltage (V) 額定工作電壓	6.3~16 25~100 160~250 350~450
	Impedance Ratio 阻抗比	Z(-25°C) / Z(20°C) 2 2 3 8 Z(-40°C) / Z(20°C) 4 3 — —
Endurance 耐久性	After 3000 hours (∅5~∅8 products are for 2000 hours) application of the rated voltage at 105°C, they meet the characteristics listed below. 在 105°C 環境中施加額定工作電壓 3000 小時 (∅5~∅8 產品為 2000 小時) 後, 電容器的特性符合下表的要求。	
	Capacitance Change 靜電容量變化率	Within ±20% of initial measured value 初始值的±20%以內
	Dissipation Factor 損耗角正切	≤200% of initial specified value 不大於規範值的 200%
Shelf Life 高溫貯存特性	After leaving capacitors under no load at 105°C for 1000 hours, they meet the specified value for load life characteristics listed above. 在 105°C 環境中無負荷放置 1000 小時後, 電容器的特性符合高溫負荷特性中所列的規定值。	
	Marking 標識 Printed with white colour on black sleeve (PVC) or printed with white colour on green sleeve (PET). 黑色膠管白字印刷 (PVC) 或綠色膠管白字印刷 (PET)。	

DRAWING & DIMENSIONS 外形圖及尺寸 (Unit: mm)

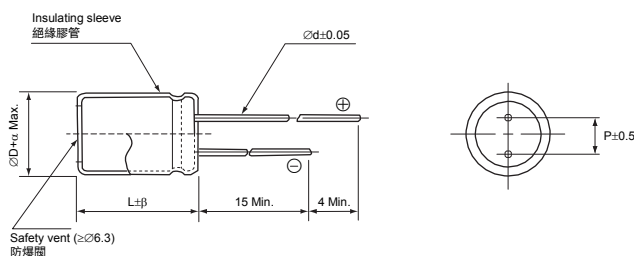

∅D	5	6.3	8 (L≤11.5)	8 (L≥16)	10	13	16	18	22
P	2.0	2.5	3.5		5.0	7.5		10.0	
∅d	0.5		0.6			0.8			
β	1.5				2.0				
α	0.5							1.0	

FREQUENCY COEFFICIENT OF ALLOWABLE RIPPLE CURRENT 紋波電流頻率補償係數

Frequency 頻率		50Hz	120Hz	300Hz	1KHz	10KHz~
Coefficient 係數	1 ~ 47µF	0.75	1.00	1.35	1.55	2.0
	68 ~ 680µF	0.80	1.00	1.25	1.34	1.5
	1000 ~ 15000µF	0.85	1.00	1.10	1.13	1.15

The endurance of capacitors is reduced with internal heating produced by ripple current at the rate of halving the lifetime with every 5~10°C rise. When long life performance is required in actual use, the rms ripple current has to be reduced. 鋁電解電容器在疊加紋波電流後會引起發熱, 溫度每上升 5~10°C 壽命會減半。若要保持長壽命性能, 請在使用過程中適當降低紋波電流。

Note: All design and specifications are for reference only and is subject to change without prior notice. If any doubt about safety for your application, please contact us immediately for technical assistance before purchase.
注: 以上所提供的設計及特性參數僅供參考, 任何修改不作預先通知。如果在使用上有疑問, 請在採購前與我們聯繫, 以便提供技術上的協助。

CAT.2023/V2

TM Series

DIMENSIONS & MAXIMUM PERMISSIBLE RIPPLE CURRENT & IMPEDANCE 規格尺寸及最大允許紋波電流及阻抗值

Parameter 參數 μF		WV		6.3 (0J)				10 (1A)			
		Case size ØD×L (mm) 尺寸	Impedance (Ω) max. 20°C, 100KHz 阻抗值	Ripple current (mA rms) 紋波電流		Case size ØD×L (mm) 尺寸	Impedance (Ω) max. 20°C, 100KHz 阻抗值	Ripple current (mA rms) 紋波電流			
				105°C, 120Hz	105°C, 100KHz			105°C, 120Hz	105°C, 100KHz		
33	330							5 × 11	2.10	74	111
47	470	5 × 11	2.10	56	117	5 × 11	1.90	88	132		
68	680	5 × 11	1.90	74	140	5 × 11	1.74	106	156		
100	101	5 × 11	1.70	113	170	5 × 11	1.30	147	221		
220	221	6.3 × 11.5	0.92	158	260	6.3 × 11.5	0.59	185	280		
330	331	6.3 × 11.5	0.83	195	300	6.3 × 11.5	0.33	215	410		
470	471	8 × 11.5	0.62	385	578	8 × 11.5 (10 × 12)	0.29 (0.25)	443 (465)	563 (630)		
680	681	8 × 11.5	0.44	483	627	8 × 11.5	0.13	482	697		
1000	102	8 × 11.5	0.36	505	645	8 × 16 (10 × 12)	0.10 (0.098)	816 (820)	928 (935)		
1200	122	8 × 16	0.18	525	685	10 × 16	0.095	835	969		
1500	152	10 × 12 (10 × 16)	0.16 (0.16)	787 (787)	964 (964)	10 × 16 (10 × 20)	0.094 (0.092)	905 (1029)	1050 (1208)		
2200	222	10 × 20	0.095	1002	1195	10 × 20 (13 × 21)	0.08 (0.08)	1006 (1103)	1200 (1315)		
3300	332	10 × 20 (13 × 21)	0.093 (0.087)	1100 (1189)	1225 (1391)	13 × 25 (16 × 20)	0.065 (0.063)	1573 (1425)	1812 (1645)		
4700	472	13 × 25	0.068	1608	1875	16 × 25	0.060	1971	2262		
6800	682	13 × 25 (16 × 25)	0.067 (0.065)	1680 (1776)	1905 (2076)	16 × 31	0.048	2390	2650		
10000	103	16 × 31	0.050	2169	2404	18 × 31	0.035	2590	2730		
15000	153	18 × 31	0.040	2380	2850						

Parameter 參數 μF		WV		16 (1C)				25 (1E)			
		Case size ØD×L (mm) 尺寸	Impedance (Ω) max. 20°C, 100KHz 阻抗值	Ripple current (mA rms) 紋波電流		Case size ØD×L (mm) 尺寸	Impedance (Ω) max. 20°C, 100KHz 阻抗值	Ripple current (mA rms) 紋波電流			
				105°C, 120Hz	105°C, 100KHz			105°C, 120Hz	105°C, 100KHz		
22	220	5 × 11	2	66	132	5 × 11	1.90	65	130		
33	330	5 × 11	1.8	81	163	5 × 11	1.60	78	156		
47	470	5 × 11	1.4	97	194	5 × 11	1.30	106	198		
68	580	5 × 11	0.93	134	201	6.3 × 11.5	0.82	152	228		
100	101	5 × 11 (6.3 × 11.5)	0.09 (0.85)	152 (163)	230 (244)	6.3 × 11.5	0.71	198	265		
220	221	6.3 × 11.5 (8 × 11.5)	0.50 (0.45)	320 (358)	400 (430)	6.3 × 11.5 (8 × 11.5)	0.46 (0.38)	305 (356)	440 (480)		
330	331	8 × 11.5	0.41	425	565	8 × 11.5 (10 × 12)	0.36 (0.25)	434 (645)	656 (840)		
470	471	6.3 × 15 (8 × 11.5) (10 × 12)	0.38 (0.35) (0.30)	465 (503) (600)	660 (707) (845)	8 × 16 (10 × 12)	0.23 (0.20)	600 (700)	949 (970)		
680	681	8 × 16 (10 × 12)	0.26 (0.24)	768 (815)	1024 (1038)	10 × 16	0.10	924	1387		
1000	102	10 × 16 (10 × 20)	0.12 (0.14)	982 (1000)	1126 (1207)	10 × 16 (10 × 20)	0.09 (0.068)	1179 (1179)	1386 (1386)		
1200	122	10 × 20	0.15	1035	1268	13 × 21	0.065	1280	1515		
1500	152	10 × 20 (13 × 21)	0.096 (0.072)	1100 (1182)	1270 (1355)	13 × 25	0.062	1403	1621		
2200	222	13 × 25	0.063	1453	1674	13 × 25 (16 × 25)	0.063 (0.055)	1500 (1567)	1774 (1839)		
3300	332	13 × 30	0.056	1619	1816	16 × 31 (18 × 25)	0.050 (0.052)	2003 (1745)	2391 (1992)		
4700	472	16 × 25	0.050	2173	2403	16 × 35	0.040	2420	2840		
6800	682	16 × 35	0.040	2440	2797	18 × 35	0.035	2840	3250		
10000	103	18 × 35	0.038	2850	3230						

Note: All design and specifications are for reference only and is subject to change without prior notice. If any doubt about safety for your application, please contact us immediately for technical assistance before purchase.

注：以上所提供的設計及特性參數僅供參考，任何修改不作預先通知。如果在使用上有疑問，請在採購前與我們聯繫，以便提供技術上的協助。

CAT.2023/V2

TM Series

□ DIMENSIONS & MAXIMUM PERMISSIBLE RIPPLE CURRENT & IMPEDANCE 規格尺寸及最大允許紋波電流及阻抗值

WV		35 (1V)				50 (1H)			
Parameter 參數 μF		Case size ∅D×L (mm) 尺寸	Impedance (Ω) max. 20°C, 100KHz 阻抗值	Ripple current (mA rms) 紋波電流		Case size ∅D×L (mm) 尺寸	Impedance (Ω) max. 20°C, 100KHz 阻抗值	Ripple current (mA rms) 紋波電流	
				105°C, 120Hz	105°C, 100KHz			105°C, 120Hz	105°C, 100KHz
1	010					5 × 11	4.2	16	32
2.2	2R2					5 × 11	4.0	18	36
3.3	3R3					5 × 11	3.8	20	40
4.7	4R7					5 × 11	2.5	29	58
6.8	6R8					5 × 11	2.2	38	76
10	100	5 × 11	1.80	55	100	5 × 11	2.0	52	104
22	220	5 × 11 (6.3 × 11.5)	1.50 (1.40)	67 (75)	134 (145)	5 × 11 (6.3 × 11.5)	1.6 (1.0)	68 (76)	136 (150)
33	330	5 × 11	1.20	81	163	6.3 × 11.5	0.8	85	175
47	470	6.3 × 11.5	1.10	114	229	6.3 × 11.5	0.71	125	225
68	680	6.3 × 11.5	0.85	137	273	8 × 11.5	0.65	215	385
100	101	6.3 × 11.5 (8 × 11.5)	0.68 (0.50)	205 (273)	340 (409)	8 × 11.5	0.4	380	480
220	221	8 × 11.5 (8 × 16)	0.27 (0.25)	484 (510)	725 (750)	8 × 16 (10 × 12)	0.25 (0.20)	580 (600)	760 (805)
330	331	8 × 16 (10 × 16)	0.16 (0.14)	540 (610)	795 (900)	10 × 20	0.10	900	1045
470	470	10 × 16 (10 × 20)	0.12 (0.10)	810 (960)	1020 (1095)	10 × 20 (13 × 21)	0.09 (0.088)	1000 (1085)	1120 (1260)
680	681	10 × 20 (10 × 25)	0.085 (0.072)	1015 (1089)	1160 (1433)	13 × 25	0.078	1275	1464
1000	102	13 × 21	0.065	1350	1490	13 × 25 (16 × 25)	0.075 (0.065)	1305 (1460)	1500 (1700)
1500	152	13 × 25	0.060	1580	1715	16 × 31	0.050	1710	1990
2200	222	16 × 25	0.055	1759	2069	16 × 35 (18 × 31)	0.045 (0.045)	2076 (2076)	2326 (2326)
3300	332	16 × 35 (18 × 25)	0.045 (0.050)	2300 (2165)	2520 (2420)	18 × 35	0.04	2500	2700
4700	472	18 × 35	0.038	2450	2875				

WV		63 (1J)				100 (2A)			
Parameter 參數 μF		Case size ∅D×L (mm) 尺寸	Impedance (Ω) max. 20°C, 100KHz 阻抗值	Ripple current (mA rms) 紋波電流		Case size ∅D×L (mm) 尺寸	Impedance (Ω) max. 20°C, 100KHz 阻抗值	Ripple current (mA rms) 紋波電流	
				105°C, 120Hz	105°C, 100KHz			105°C, 120Hz	105°C, 100KHz
1	010					5 × 11	7	47	66
2.2	2R2					5 × 11	6	66	72
3.3	3R3					5 × 11	5	68	78
4.7	4R7	5 × 11	2.5	45	71	5 × 11	4	72	88
10	100	5 × 11	1.5	50	81	6.3 × 11.5	1.2	100	180
22	220	5 × 11	1.2	110	165	8 × 11.5	0.66	196	282
33	330	6.3 × 11.5	0.85	135	210	8 × 11.5	0.5	310	380
47	470	8 × 11.5	0.56	210	330	8 × 16 (10 × 12)	0.32 (0.25)	405 (460)	500 (630)
68	680	8 × 11.5	0.56	210	330	10 × 16	0.25	515	780
100	101	8 × 16 (10 × 12)	0.50 (0.40)	370 (380)	581 (600)	10 × 16 (10 × 20)	0.22 (0.16)	600 (650)	820 (890)
220	221	10 × 16 (10 × 20)	0.35 (0.27)	540 (710)	850 (1000)	13 × 25	0.13	920	1280
330	331	10 × 20 (13 × 21)	0.20 (0.16)	860 (950)	1100 (1200)	16 × 25	0.09	1200	1440
470	471	13 × 25	0.14	1100	1300	16 × 31	0.06	1560	1790
680	681	16 × 25	0.08	1215	1450	18 × 35	0.055	1650	1850
1000	102	16 × 25 (16 × 31)	0.06 (0.06)	1295 (1350)	1525 (1600)	18 × 40	0.051	1700	2040
2200	222	18 × 40	0.045	1500	1800				

Note: All design and specifications are for reference only and is subject to change without prior notice. If any doubt about safety for your application, please contact us immediately for technical assistance before purchase.

注：以上所提供的設計及特性參數僅供參考，任何修改不作預先通知。如果在使用上有疑問，請在採購前與我們聯繫，以便提供技術上的協助。

CAT.2023/V2

TM Series

DIMENSIONS & MAXIMUM PERMISSIBLE RIPPLE CURRENT & IMPEDANCE 規格尺寸及最大允許紋波電流及阻抗值

WV		160 (2C)				200 (2D)			
Parameter 參數 μF		Case size ∅D×L (mm) 尺寸	Impedance (Ω) max. 20°C, 100KHz 阻抗值	Ripple current (mA rms) 紋波電流		Case size ∅D×L (mm) 尺寸	Impedance (Ω) max. 20°C, 100KHz 阻抗值	Ripple current (mA rms) 紋波電流	
				105°C, 120Hz	105°C, 100KHz			105°C, 120Hz	105°C, 100KHz
10	100					8 × 11.5 (10 × 12)	7.80 (6.20)	225 (240)	295 (320)
22	220	10 × 20	1.30	315	440	10 × 16 (10 × 20)	4.30 (4.20)	285 (300)	365 (380)
33	330	10 × 20	1.30	405	565	13 × 21	3.0	425	560
47	470	10 × 20 (13 × 21)	1.12 (0.91)	495 (525)	685 (725)	13 × 21	2.6	510	785
68	680	13 × 25	0.63	680	950	13 × 25	1.4	645	875
100	101	16 × 25 (16 × 31)	0.27 (0.25)	920 (925)	1280 (1290)	13 × 25	0.95	715	980
150	151	16 × 31	0.22	930	1300	16 × 31 (18 × 25)	0.80 (0.72)	745 (730)	995 (985)
220	221	16 × 31	0.22	930	1300	18 × 31	0.45	750	1000
330	331	16 × 35 (18 × 31)	0.22	1580	1700	18 × 35 (22 × 35)	0.38 (0.28)	760 (795)	1050 (1135)

WV		250 (2E)				350 (2V)			
Parameter 參數 μF		Case size ∅D×L (mm) 尺寸	Impedance (Ω) max. 20°C, 100KHz 阻抗值	Ripple current (mA rms) 紋波電流		Case size ∅D×L (mm) 尺寸	Impedance (Ω) max. 20°C, 100KHz 阻抗值	Ripple current (mA rms) 紋波電流	
				105°C, 120Hz	105°C, 100KHz			105°C, 120Hz	105°C, 100KHz
4.7	4R7	8 × 11.5	7.00	90	145	8 × 11.5 (10 × 12)	6.5 (6.2)	115 (140)	460 (195)
6.8	6R8	10 × 12	5.80	115	180	10 × 12 (10 × 16)	5.4 (5.0)	145 (150)	210 (220)
10	100	10 × 16	4.50	150	245	10 × 16 (10 × 20)	4.5 (4.2)	160 (175)	230 (275)
22	220	10 × 20	3.20	265	360	13 × 21 (13 × 25)	3.9 (2.5)	295 (300)	400 (455)
33	330	13 × 21	2.50	310	495	13 × 25 (16 × 20)	3.4 (3.0)	405 (465)	525 (645)
47	470	13 × 25	1.90	425	570	16 × 25	2.8	550	705
68	680	16 × 25	1.20	480	655	16 × 31	2.0	625	825
100	101	16 × 31 (18 × 31)	0.65 (0.40)	505 (550)	690 (750)	16 × 35 (18 × 31)	1.2 (0.7)	700 (705)	905 (960)
150	151	18 × 35 (22 × 35)	0.30 (0.24)	600 (630)	845 (900)	18 × 35	0.6	1020	1050
220	221	22 × 35	0.25	750	1000				

WV		400 (2G)				450 (2W)			
Parameter 參數 μF		Case size ∅D×L (mm) 尺寸	Impedance (Ω) max. 20°C, 100KHz 阻抗值	Ripple current (mA rms) 紋波電流		Case size ∅D×L (mm) 尺寸	Impedance (Ω) max. 20°C, 100KHz 阻抗值	Ripple current (mA rms) 紋波電流	
				105°C, 120Hz	105°C, 100KHz			105°C, 120Hz	105°C, 100KHz
2.2	2R2	6.3 × 11.5 (8 × 11.5)	8.8 (8.0)	80 (95)	110 (130)	8 × 11.5	7.0	95	138
3.3	3R3	8 × 11.5	8.0	105	140	8 × 11.5	6.0	105	140
4.7	4R7	8 × 11.5 (10 × 12)	8.0 (6.0)	130 (135)	175 (210)	10 × 12	5.6	150	200
6.8	6R8	10 × 12 (10 × 16)	5.0 (4.5)	150 (160)	220 (230)	10 × 16	6.5	205	265
10	100	10 × 16 (10 × 20)	3.6 (3.6)	195 (205)	265 (285)	10 × 20	9.0	235	320
22	220	13 × 21	3.8	310	420	13 × 35	6.0	415	570
33	330	16 × 20 (16 × 25)	3.4 (3.0)	405 (465)	525 (645)	16 × 31	2.4	385	710
47	470	16 × 25 (16 × 31)	2.8 (2.6)	550 (585)	705 (775)	16 × 35 (18 × 26)	1.8 (1.2)	515 (585)	755 (800)
68	680	16 × 31	2.0	625	825	18 × 31	1.0	620	845
100	101	18 × 31 (18 × 35)	1.2 (0.7)	700 (705)	905 (960)	18 × 35	0.64	380	520
150	151	18 × 40	0.6	1020	1050				

- Please refer to page 19 "Taping Specifications" & page 21 "Lead Forming & Cutting" about the taped or formed product spec. 編帶與引線成型標準請查閱第 19 頁“編帶標準”及第 21 頁“引線成型與剪腳”。
- Please refer to page 20 "Packaging Specifications" for the minimum package quantity. 最小包裝數量請查閱第 20 頁“包裝標準”。
- Please refer to page 16 for the Part Number System. 產品編碼規則請查閱第 16 頁。

Note: All design and specifications are for reference only and is subject to change without prior notice. If any doubt about safety for your application, please contact us immediately for technical assistance before purchase.
 注：以上所提供的設計及特性參數僅供參考，任何修改不作預先通知。如果在使用上有疑問，請在採購前與我們聯繫，以便提供技術上的協助。

CAT.2023/V2

TN Series

EXTREMELY LOW IMPEDANCE

極低阻抗品

- Extremely low impedance at high frequency
高頻極低阻抗
- Ideally suited for use of switching power supplies
適用於開關電源
- Endurance 5000 hours
(2000~3000 hours for smaller case sizes as specified below)
耐久性 5000 小時 (小尺寸為 2000~3000 小時)
- Comply with the RoHS & REACH
符合 RoHS 與 REACH

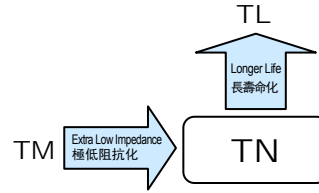
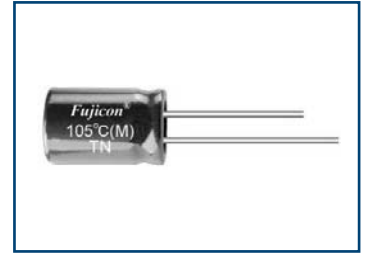

SPECIFICATIONS 特性表

Items 項目	Characteristics 主要特性	
Category 工作溫度範圍	-40 ~ +105°C	-25 ~ +105°C
Voltage Range 額定工作電壓範圍	6.3 ~ 63V	160 ~ 450V
Capacitance Range 靜電容量範圍	1 ~ 15000µF	22 ~ 330µF
Capacitance Tolerance 靜電容量允許偏差	±20% at 120Hz, 20°C	
Leakage Current 漏電流	Leakage current ≤0.01CV or 3µA, whichever is greater (after 2 minutes application of rated voltage at 20°C) 漏電流 ≤0.01CV 或 3µA 取較大值(在 20°C 環境中施加額定工作電壓 2 分鐘後)	Leakage current ≤0.02CV + 15µA (after 5 minutes application of rated voltage at 20°C) 漏電流 ≤0.02CV + 15µA(在 20°C 環境中施加額定工作電壓 5 分鐘後)
Dissipation Factor (tan δ) 損耗角正切	C: Nominal capacitance (µF) 標稱靜電容量, V: Rated voltage (V) 額定電壓 When nominal capacitance is over 1000µF, tan δ shall be added 0.02 to the listed value with increase of every 1000µF. 當標稱靜電容量大於 1000µF, 其標稱靜電容量每增加 1000µF, 損耗角正切增加 0.02。 Measurement frequency 測試頻率: 120Hz, Temperature 溫度: 20°C	
Stability at Low Temperature 低溫特性	Measurement frequency 測試頻率: 120Hz	
Endurance 耐久性	The characteristics listed below shall be satisfied when the capacitors are restored to 20°C after subject to DC voltage with the rated ripple current is applied (the peak voltage shall not exceed the rated voltage) for the specified period of time at 105°C. 在 105°C 環境中的規定時間內施加額定紋波電流 (峰值電壓不得超過額定電壓) 後, 電容器經直流電壓後恢復至 20°C 時, 應符合下表參數要求。	
	Rated Voltage (V) 額定工作電壓	6.3, 10, 16, 25, 35, 50, 63, 100, 160~250, 350~450
	tan δ (max.) 最大損耗角正切	0.22, 0.19, 0.16, 0.14, 0.12, 0.10, 0.09, 0.08, 0.15, 0.20
	Impedance Ratio 阻抗比	Z(-25°C) / Z(20°C) Z(-40°C) / Z(20°C)
Shelf Life 高溫貯存特性	After leaving capacitors under no load at 105°C for 1000 hours, they meet the specified value for load life characteristics listed above. 在 105°C 環境中無負荷放置 1000 小時後, 電容器的特性符合高溫負荷特性中所列的規定值。	
Marking 標識	Printed with white colour on black sleeve (PVC) or printed with white colour on green sleeve (PET). 黑色膠管白字印刷 (PVC) 或綠色膠管白字印刷 (PET)。	

DRAWING 外形圖 (Unit: mm)

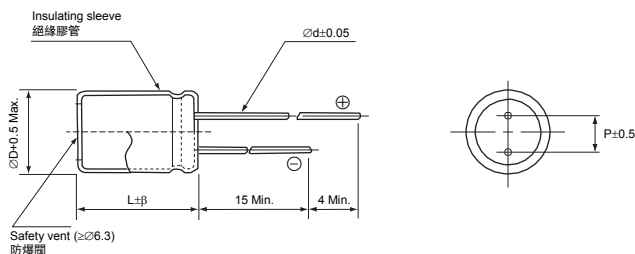

ØD	5	6.3	8 (L≤11.5)	8 (L≤16)	10	13	16	18
P	2.0	2.5	3.5		5.0	7.5		
Ød	0.5		0.6			0.8		
β	1.5					2.0		

FREQUENCY COEFFICIENT OF ALLOWABLE RIPPLE CURRENT 紋波電流頻率補償係數

Frequency 頻率	50Hz	120Hz	300Hz	1KHz	10KHz~
Coefficient 係數	1 ~ 47µF	0.75	1.00	1.35	2.0
	68 ~ 680µF	0.80	1.00	1.25	1.5
	1000 ~ 15000µF	0.85	1.00	1.10	1.13

The endurance of capacitors is reduced with internal heating produced by ripple current at the rate of halving the lifetime with every 5~10°C rise. When long life performance is required in actual use, the rms ripple current has to be reduced. 鋁電解電容器在疊加紋波電流後會引起發熱, 溫度每上升 5~10°C 壽命會減半。若要保持長壽命性能, 請在使用過程中適當降低紋波電流。

Note: All design and specifications are for reference only and is subject to change without prior notice. If any doubt about safety for your application, please contact us immediately for technical assistance before purchase.
注: 以上所提供的設計及特性參數僅供參考, 任何修改不作預先通知。如果在使用上有疑問, 請在採購前與我們聯繫, 以便提供技術上的協助。

CAT.2023/V2

TN Series

□ DIMENSIONS & MAXIMUM PERMISSIBLE RIPPLE CURRENT & IMPEDANCE 規格尺寸及最大允許紋波電流及阻抗值

WV		6.3 (0J)				10 (1A)				16 (1C)				25 (1E)			
Parameter 參數	μF	Case size ∅D×L (mm) 尺寸	Impedance (Ω) max. 20°C, 100KHz 阻抗值	Ripple current (mA rms) 紋波電流		Case size ∅D×L (mm) 尺寸	Impedance (Ω) max. 20°C, 100KHz 阻抗值	Ripple current (mA rms) 紋波電流		Case size ∅D×L (mm) 尺寸	Impedance (Ω) max. 20°C, 100KHz 阻抗值	Ripple current (mA rms) 紋波電流		Case size ∅D×L (mm) 尺寸	Impedance (Ω) max. 20°C, 100KHz 阻抗值	Ripple current (mA rms) 紋波電流	
				105°C, 120Hz	105°C, 100KHz			105°C, 120Hz	105°C, 100KHz			105°C, 120Hz	105°C, 100KHz			105°C, 120Hz	105°C, 100KHz
33	330																
47	470					5 × 11	0.90	75	125	5 × 11	0.80	92	155	5 × 11	0.80	88	155
68	680					5 × 11	0.80	97	155	6.3×11.5	0.50	135	220	6.3×11.5	0.55	125	210
100	101	5 × 11	0.85	99	150	5 × 11 (6.3×11.5)	0.70 (0.55)	115 (135)	185 (210)	6.3×11.5	0.35	175	265	6.3×11.5 (8 × 11.5)	0.32 (0.24)	195 (254)	312 (383)
150	151	6.3×11.5	0.49	155	225	6.3×11.5	0.35	185	265	8 × 11.5	0.23	270	388	8 × 11.5	0.16	320	460
220	221	6.3×11.5	0.30	205	285	6.3×11.5 (8×11.5)	0.30 (0.24)	225 (283)	305 (387)	8 × 11.5	0.16	335	460	8 × 11.5 (10×12)	0.14 (0.13)	370 (435)	500 (600)
330	331	6.3×11.5 (8 × 11.5)	0.26 (0.20)	220 (223)	290 (292)	6.3×11.5 (8 × 11.5)	0.20 (0.16)	305 (350)	425 (460)	8 × 11.5 (10 × 12)	0.14 (0.12)	400 (480)	520 (625)	8 × 16 (10 × 12)	0.12 (0.10)	450 (595)	545 (680)
470	471	8 × 11.5 (10 × 12)	0.18 (0.14)	325 (455)	435 (575)	8 × 11.5 (10 × 12)	0.15 (0.13)	405 (475)	575 (600)	8 × 11.5 (10 × 12)	0.12 (0.10)	575 (520)	645 (680)	10 × 16 (10 × 20)	0.084 (0.065)	680 (810)	890 (1020)
680	681	10 × 16	0.11	580	700	10 × 12 (10 × 16)	0.11 (0.09)	545 (635)	650 (770)	10 × 20	0.065	845	1020	10 × 20 (13 × 21)	0.054 (0.046)	985 (1160)	1165 (1392)
1000	102	10 × 12 (10 × 20)	0.095 (0.075)	715 (820)	865 (950)	8 × 16 (10 × 20)	0.068 (0.060)	760 (915)	880 (1060)	10 × 16 (10 × 20)	0.058 (0.055)	850 (950)	1060 (1185)	10 × 20 (13 × 21) (13 × 25)	0.046 (0.043) (0.036)	1150 (1200) (1430)	1400 (1475) (1660)
1500	152	10 × 25	0.055	1090	1220	10 × 20 (13 × 21)	0.058 (0.045)	1020 (1266)	1245 (1417)	10 × 20 (13 × 25)	0.050 (0.036)	1050 (1490)	1245 (1660)	16 × 20	0.034	1590	1770
2200	222	10 × 20 (13 × 21)	0.050 (0.043)	1115 (1296)	1305 (1438)	10 × 25 (13 × 25)	0.038 (0.034)	1375 (1530)	1550 (1710)	13 × 21 (13 × 25) (16 × 20)	0.035 (0.035) (0.033)	1485 (1545) (1620)	1695 (1705) (1800)	13 × 25 (16 × 25)	0.030 (0.028)	1645 (1848)	1750 (2051)
3300	332	13 × 25	0.034	1530	1710	16 × 20	0.031	1660	1850	13 × 25 (16 × 25)	0.034 (0.027)	1700 (1888)	1725 (2095)	16 × 35	0.020	2410	2680
4700	472	16 × 25	0.032	1728	1935	16 × 31	0.023	2170	2420	16 × 35	0.020	2410	2680	18 × 31 (18 × 40)	0.019 (0.018)	2515 (2660)	2785 (2960)
6800	682	16 × 31	0.024	2130	2370	16 × 35	0.020	2410	2680	18 × 35	0.018	2610	2900				
10000	103	16 × 40	0.020	2470	2750	18 × 40	0.017	2730	3040								
15000	153	18 × 40	0.018	2660	2960												

WV		35V (1V)				50V (1H)				63V (1J)			
Parameter 參數	μF	Case size ∅D×L (mm) 尺寸	Impedance (Ω) max. 20°C, 100KHz 阻抗值	Ripple current (mA rms) 紋波電流		Case size ∅D×L (mm) 尺寸	Impedance (Ω) max. 20°C, 100KHz 阻抗值	Ripple current (mA rms) 紋波電流		Case size ∅D×L (mm) 尺寸	Impedance (Ω) max. 20°C, 100KHz 阻抗值	Ripple current (mA rms) 紋波電流	
				105°C, 120Hz	105°C, 100KHz			105°C, 120Hz	105°C, 100KHz			105°C, 120Hz	105°C, 100KHz
1	101					5 × 11	4.0	18	36				
1.5	1R5					5 × 11	3.8	22	45				
2.2	2R2					5 × 11	3.5	27	54				
3.3	3R3					5 × 11	3.0	33	66				
4.7	4R7					5 × 11	2.2	40	81				
6.8	6R8					5 × 11	1.8	45	91				
10	100					5 × 11	1.4	57	115	5 × 11	1.06	67	135
15	150					5 × 11	0.93	72	145	6.3 × 11.5	0.73	92	185
22	220	5 × 11	0.75	85	160	5 × 11 (6.3 × 11.5)	0.86 (0.65)	85 (100)	165 (195)	6.3 × 11.5	0.52	110	215
33	330	6.3 × 11.5	0.49	125	225	6.3 × 11.5	0.43	135	240	8 × 11.5	0.35	179	320
47	470	6.3 × 11.5	0.34	160	270	6.3 × 11.5 (8 × 11.5)	0.10 (0.30)	170 (204)	300 (344)	8 × 11.5	0.25	215	365
68	680	8 × 11.5	0.24	239	384	8 × 11.5	0.20	255	410	10 × 12	0.19	310	495
100	101	8 × 11.5	0.16	305	460	8 × 16 (10 × 16)	0.18 (0.16)	315 (385)	490 (581)	8 × 16 (10 × 20)	0.16 (0.12)	400 (495)	615 (750)
150	151	10 × 12	0.12	435	625	10 × 20	0.10	570	820	10 × 25	0.09	665	950
220	221	8 × 16 (10 × 12) (10 × 16)	0.12 (0.10) (0.09)	485 (520) (560)	700 (735) (770)	10 × 16 (10 × 20) (10 × 25)	0.09 (0.09) (0.075)	615 (650) (760)	850 (900) (1040)	10 × 20 (13 × 21)	0.080 (0.065)	785 (835)	1010 (1140)
330	331	10 × 16 (10 × 20)	0.063 (0.060)	745 (810)	1000 (1060)	10 × 20 (13 × 21)	0.058 (0.055)	885 (978)	1150 (1281)	13 × 21 (13 × 25)	0.056 (0.049)	945 (1090)	1295 (1420)
470	471	10 × 20 (13 × 21)	0.050 (0.046)	995 (1112)	1300 (1401)	10 × 20 (13 × 21)	0.054 (0.050)	980 (1085)	1285 (1385)	13 × 25 (16 × 25)	0.045 (0.042)	1220 (1350)	1580 (1700)
680	681	13 × 25	0.036	1370	1660	16 × 20	0.040	1350	1630	16 × 31	0.032	1700	2050
1000	102	16 × 20	0.034	1330	1770	16 × 25 (16 × 31)	0.036 (0.030)	1755 (1830)	1950 (2120)	16 × 31 (18 × 31) (18 × 35)	0.032 (0.032) (0.029)	1840 (1840) (1970)	2180 (2180) (2280)
1500	152	16 × 31	0.028	2149	2385	16 × 35	0.026	2170	2410	18 × 35	0.026	1850	2165
2200	222	16 × 31 (16 × 35)	0.024 (0.020)	2365 (2410)	2600 (2680)	18 × 35 (18 × 40)	0.026 (0.024)	2265 (2300)	2485 (2560)				
3300	332	18 × 40	0.017	2730	3040								

Note: All design and specifications are for reference only and is subject to change without prior notice. If any doubt about safety for your application, please contact us immediately for technical assistance before purchase.

注：以上所提供的設計及特性參數僅供參考，任何修改不作預先通知。如果在使用上有疑問，請在採購前與我們聯繫，以便提供技術上的協助。

CAT.2023/V2

TN Series

□ DIMENSIONS & MAXIMUM PERMISSIBLE RIPPLE CURRENT & IMPEDANCE 規格尺寸及最大允許紋波電流及阻抗值

Parameter 參數 μF		100 (2A)				160 (2C)				200 (2D)				250 (2E)				
		Case size ØD×L (mm) 尺寸	Impedance (Ω) max. 20°C, 100KHz 阻抗值	Ripple current (mA rms) 紋波電流		Case size ØD×L (mm) 尺寸	Impedance (Ω) max. 20°C, 100KHz 阻抗值	Ripple current (mA rms) 紋波電流		Case size ØD×L (mm) 尺寸	Impedance (Ω) max. 20°C, 100KHz 阻抗值	Ripple current (mA rms) 紋波電流		Case size ØD×L (mm) 尺寸	Impedance (Ω) max. 20°C, 100KHz 阻抗值	Ripple current (mA rms) 紋波電流		
				105°C, 120Hz	105°C, 100KHz			105°C, 120Hz	105°C, 100KHz			105°C, 120Hz	105°C, 100KHz			105°C, 120Hz	105°C, 100KHz	
2.2	2R2	5 × 11	2.50	25	52										5 × 11	0.80	88	155
3.3	3R3	5 × 11	2.50	30	64										8 × 11.5	1.40	105	200
4.7	4R7	5 × 11	2.50	35	76										8 × 11.5	2.00	135	240
6.8	6R8	6.3×11.5	1.00	70	128										8 × 11.5	2.80	165	275
10	100	8 × 11.5	0.60	125	224										10 × 16	3.50	170	300
22	220	8 × 11.5 (10×12)	0.50 (0.40)	130 (185)	285 (319)	10 × 20	1.30	310	440	10 × 20	1.5	310	440	13 × 21	2.30	315	480	
33	330	10 × 16	0.30	285	417	10 × 20	1.30	395	565	13 × 21	0.91	390	590	13 × 25	1.70	435	630	
47	470	10 × 16 (13×21)	0.08 (0.15)	445 (380)	680 (570)	13 × 21	0.91	470	725	13 × 21	0.91	515	780	13 × 25	1.70	435	630	
68	680	13 × 25	0.12	490	760	13 × 25	0.63	675	950	13 × 25	0.63	675	950	16 × 25	0.78	765	1000	
100	101	10 × 16 (16×25)	0.22 (0.07)	450 (905)	700 (1250)	16 × 25	0.27	980	1280	16 × 25	0.27	980	1280	16 × 31	0.63	1080	1400	
150	151	16 × 31	0.05	1080	1400	16 × 31	0.22	1015	1300	18 × 25	0.27	1190	1500	18 × 31	0.42	1100	1450	
220	221	18 × 40	0.03	1695	1980	16 × 31	0.22	1015	1300	18 × 31	0.22	1350	1700	18 × 40	0.35	1175	1485	
330	331					18 × 31	0.22	1350	1700									

Parameter 參數 μF		350V (2V)				400V (2G)				450V (2W)			
		Case size ØD×L (mm) 尺寸	Impedance (Ω) max. 20°C, 100KHz 阻抗值	Ripple current (mA rms) 紋波電流		Case size ØD×L (mm) 尺寸	Impedance (Ω) max. 20°C, 100KHz 阻抗值	Ripple current (mA rms) 紋波電流		Case size ØD×L (mm) 尺寸	Impedance (Ω) max. 20°C, 100KHz 阻抗值	Ripple current (mA rms) 紋波電流	
				105°C, 120Hz	105°C, 100KHz			105°C, 120Hz	105°C, 100KHz			105°C, 120Hz	105°C, 120Hz
3.3	3R3					8 × 11.5	4.80	60	110	10 × 20	6.5	75	150
4.7	4R7					8 × 11.5	4.20	75	125	13 × 21	3.6	105	200
10	100	10 × 20	2.90	100	180	10 × 20	2.90	95	180	13 × 25	2.5	185	315
22	220	13 × 21	2.10	160	270	13 × 25	1.30	175	300	16 × 25	1.7	380	570
33	330	16 × 20	0.91	365	600	16 × 20	0.91	365	600	16 × 31	1.1	435	620
47	470	16 × 25	0.73	485	700	16 × 25	0.73	485	700	18 × 31	0.93	650	900
68	680	16 × 31	0.49	845	1100	16 × 31	0.49	845	1100	18 × 35	0.71	670	980
100	101	18 × 31	0.40	855	1170	18 × 40	0.34	975	1250				

- Please refer to page 19 "Taping Specifications" & page 21 "Lead Forming & Cutting" about the taped or formed product spec. 編帶與引線成型標準請查閱第 19 頁 "編帶標準" 及第 21 頁 "引線成型與剪腳"。
- Please refer to page 20 "Packaging Specifications" for the minimum package quantity. 最小包裝數量請查閱第 20 頁 "包裝標準"。
- Please refer to page 16 for the Part Number System. 產品編碼規則請查閱第 16 頁。

Note: All design and specifications are for reference only and is subject to change without prior notice. If any doubt about safety for your application, please contact us immediately for technical assistance before purchase.
 注：以上所提供的設計及特性參數僅供參考，任何修改不作預先通知。如果在使用上有疑問，請在採購前與我們聯繫，以便提供技術上的協助。

CAT.2023/V2

RZ Series New
新品

SLEEVELESS, LONG LIFE WITH EXTRA LOWER IMPEDANCE

無膠管，長壽命極低阻抗品



- Extra lower impedance with temperature range -55~+105°C
極低阻抗和適用於 -55~+105°C 的溫度範圍
- Endurance 2000~5000 hours
耐久性 2000~5000 小時
- Sleeveless
無膠管
- RoHS & REACH compliant, Halogen-free
符合 RoHS 與 REACH，無鹵

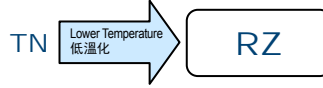

□ SPECIFICATIONS 特性表

Items 項目	Characteristics 主要特性																											
Operation Temperature Range 使用溫度範圍	-55 ~ +105°C																											
Voltage Range 額定工作電壓範圍	6.3 ~ 100V																											
Capacitance Range 靜電容量範圍	3.3 ~ 8200µF																											
Capacitance Tolerance 靜電容量允許偏差	±20% at 120Hz, 20°C																											
Leakage Current 漏電流	Leakage current ≤0.01CV or 3µA (∅4~∅10), whichever is greater (after 2 minutes application of rated voltage at 20°C) Leakage current ≤0.03CV or 4µA (∅12.5~∅18), whichever is greater (after 1 minute application of rated voltage at 20°C) 漏電流 ≤0.01CV 或 3µA (∅4~∅10)，取較大值（在 20°C 環境中施加額定工作電壓 2 分鐘後） 漏電流 ≤0.03CV 或 4µA (∅12.5~∅18)，取較大值（在 20°C 環境中施加額定工作電壓 1 分鐘後） C: Nominal capacitance (µF) 標稱靜電容量, V: Rated voltage (V) 額定電壓																											
Dissipation Factor (tan δ) 損耗角正切	Measurement frequency 測試頻率: 120Hz, Temperature 溫度: 20°C <table border="1"> <thead> <tr> <th>Rated Voltage (V) 額定工作電壓</th> <th>6.3</th> <th>10</th> <th>16</th> <th>25</th> <th>35</th> <th>50</th> <th>63~80</th> <th>100</th> </tr> </thead> <tbody> <tr> <td>tan δ (max.) ∅4~∅10</td> <td>0.26</td> <td>0.19</td> <td>0.16</td> <td>0.14</td> <td>0.12</td> <td>0.10</td> <td>0.08</td> <td>0.07</td> </tr> <tr> <td>最大損耗角正切 ∅12.5~∅18</td> <td>0.26</td> <td>0.19</td> <td>0.18</td> <td>0.16</td> <td>0.14</td> <td>0.10</td> <td>0.08</td> <td>0.07</td> </tr> </tbody> </table>	Rated Voltage (V) 額定工作電壓	6.3	10	16	25	35	50	63~80	100	tan δ (max.) ∅4~∅10	0.26	0.19	0.16	0.14	0.12	0.10	0.08	0.07	最大損耗角正切 ∅12.5~∅18	0.26	0.19	0.18	0.16	0.14	0.10	0.08	0.07
Rated Voltage (V) 額定工作電壓	6.3	10	16	25	35	50	63~80	100																				
tan δ (max.) ∅4~∅10	0.26	0.19	0.16	0.14	0.12	0.10	0.08	0.07																				
最大損耗角正切 ∅12.5~∅18	0.26	0.19	0.18	0.16	0.14	0.10	0.08	0.07																				
Stability at Low Temperature 低溫特性	Measurement frequency 測試頻率: 120Hz <table border="1"> <thead> <tr> <th>Rated Voltage (V) 額定工作電壓</th> <th>6.3 ~ 16</th> <th>25 ~ 100</th> </tr> </thead> <tbody> <tr> <td>Impedance Ratio 阻抗比 Z(-25°C) / Z(20°C)</td> <td>2</td> <td>2</td> </tr> <tr> <td>Z(-40°C) / Z(20°C)</td> <td>3</td> <td>3</td> </tr> <tr> <td>ZT/Z20 (max.) Z(-55°C) / Z(20°C)</td> <td>4</td> <td>3</td> </tr> </tbody> </table>	Rated Voltage (V) 額定工作電壓	6.3 ~ 16	25 ~ 100	Impedance Ratio 阻抗比 Z(-25°C) / Z(20°C)	2	2	Z(-40°C) / Z(20°C)	3	3	ZT/Z20 (max.) Z(-55°C) / Z(20°C)	4	3															
Rated Voltage (V) 額定工作電壓	6.3 ~ 16	25 ~ 100																										
Impedance Ratio 阻抗比 Z(-25°C) / Z(20°C)	2	2																										
Z(-40°C) / Z(20°C)	3	3																										
ZT/Z20 (max.) Z(-55°C) / Z(20°C)	4	3																										
Endurance 耐久性	After 5000 hrs. (2000 hrs. for ∅4~∅6.3×5.8) application of the rated voltage at 105°C, they meet the characteristics listed below. 在 105°C 環境中施加額定工作電壓 5000 小時（∅4~∅6.3×5.8 為 2000 小時）後，電容器的特性符合下表的要求。 <table border="1"> <tbody> <tr> <td>Capacitance Change 靜電容量變化率</td> <td>Within ±30% of initial value 初始值的±30%以內</td> </tr> <tr> <td>Dissipation Factor 損耗角正切</td> <td>200% or less of initial specified value 不大於規範值的 200%</td> </tr> <tr> <td>Leakage Current 漏電流</td> <td>initial specified value or less 不大於規範值</td> </tr> </tbody> </table>	Capacitance Change 靜電容量變化率	Within ±30% of initial value 初始值的±30%以內	Dissipation Factor 損耗角正切	200% or less of initial specified value 不大於規範值的 200%	Leakage Current 漏電流	initial specified value or less 不大於規範值																					
Capacitance Change 靜電容量變化率	Within ±30% of initial value 初始值的±30%以內																											
Dissipation Factor 損耗角正切	200% or less of initial specified value 不大於規範值的 200%																											
Leakage Current 漏電流	initial specified value or less 不大於規範值																											
Shelf Life 高溫貯存特性	After leaving capacitors under no load at 105°C for 1000 hours, they meet the specified value for load life characteristics listed above. 在 105°C 環境中無負荷放置 1000 小時後，電容器的特性符合高溫負荷特性中所列的規定值。																											
Marking 標識	Black print on the case top. 鋁殼頂部黑字印刷。																											

□ DRAWING 外形圖 (Unit: mm)

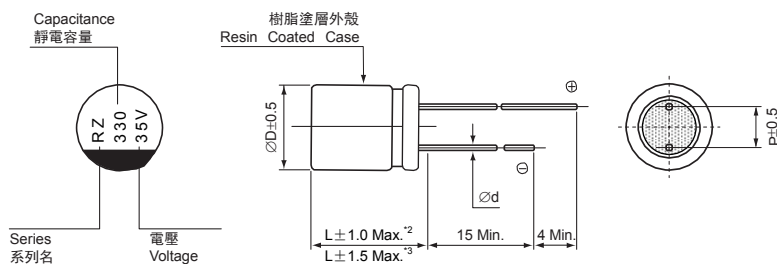

*1. Voltage mark for 6.3V is [6V]
*2. Applicable to ∅4~∅8
*3. Applicable to ∅10 and above

6.3V 的產品標識為 [6V]
適用於∅4~∅8
適用於∅10 和∅10 以上

Dimension table in next page.
尺寸表見下一頁。

Note: All design and specifications are for reference only and is subject to change without prior notice. If any doubt about safety for your application, please contact us immediately for technical assistance before purchase.

注：以上所提供的設計及特性參數僅供參考，任何修改不作預先通知。如果在使用上有疑問，請在採購前與我們聯繫，以便提供技術上的協助。

CAT.2023/V2

RZ Series New 新品

□ DIMENSIONS (Unit: mm) 尺寸表

∅D x L	4 x 5	5 x 5	6.3 x 5/7	8 x 10	10 x 10/13	12.5 x 13/16	16 x 16	18 x 16/18
P	1.5	2.0	2.5	3.5	5.0	5.0	7.5	7.5
∅d	0.45	0.45	0.45	0.5	0.6	0.6	0.8	0.8
L	5.0	5.0	5.0/7.0	10.0	10.0/13.0	13.0/16.0	16.0	16.0/18.0

□ DIMENSIONS & MAXIMUM PERMISSIBLE RIPPLE CURRENT & IMPEDANCE 規格尺寸及最大允許紋波電流及阻抗值

μF	WV Code 代碼	6.3			10			16		
		0J			1A			1C		
10	100							4 x 5	1.35	90
15	150							4 x 5	1.35	90
22	220	4 x 5	1.35	90	4 x 5	1.35	90	5 x 5	0.76	160
33	330	5 x 5 (4 x 5)	0.76 (1.35)	160 (90)	5 x 5	0.76	160	6.3 x 5	0.44	240
47	470	5 x 5 (4 x 5)	0.76 (1.35)	160 (90)	6.3 x 5	0.44	240	6.3 x 5 (5 x 5)	0.44 (0.76)	240 (160)
56	560	5 x 5	0.76	160	6.3 x 5	0.44	240	6.3 x 5	0.44	240
68	680	6.3 x 5	0.44	240	6.3 x 5	0.44	240	6.3 x 7 (6.3 x 5)	0.34 (0.44)	300 (240)
100	101	6.3 x 5	0.44	240	6.3 x 7	0.34	300	6.3 x 7 (6.3 x 5)	0.34 (0.44)	300 (240)
150	151	6.3 x 5	0.44	240	6.3 x 7	0.34	300	6.3 x 7	0.34	300
220	221	6.3 x 7 (6.3 x 5)	0.34 (0.44)	300 (240)	6.3 x 7	0.34	300	8 x 10 (6.3 x 7)	0.17 (0.34)	600 (300)
330	331	8 x 10	0.17	600	10 x 10 (8 x 10)	0.09 (0.17)	850 (600)	10 x 10 (8 x 10)	0.08 (0.17)	850 (600)
470	471	8 x 10	0.17	600	10 x 10 (8 x 10)	0.09 (0.17)	850 (600)	10 x 10 (8 x 10)	0.09 (0.17)	850 (600)
680	681	10 x 10 (8 x 10)	0.09 (0.17)	850 (600)	10 x 10	0.09	850	10 x 13 (10 x 10)	0.07 (0.09)	950 (850)
1000	102	10 x 10 (8 x 10)	0.09 (0.17)	850 (600)	10 x 13 (10 x 10)	0.07 (0.09)	950 (850)	12.5 x 16 (12.5 x 13)	0.055 (0.06)	1200 (1100)
1500	152	10 x 13	0.09	950	12.5 x 13	0.06	1100	16 x 16	0.05	1450
2200	222	12.5 x 13	0.06	1100	12.5 x 16	0.055	1200	16 x 16	0.05	1450
3300	332	12.5 x 16 (12.5 x 13)	0.055 (0.06)	1200 (1100)	16 x 16	0.05	1260	16 x 16	0.05	1450
4700	472	16 x 16	0.05	1450	16 x 16	0.05	1450	18 x 16	0.048	1500
6800	682	18 x 16	0.048	1500	18 x 16	0.048	1500	Case size 尺寸	Impedance 阻抗值	Ripple current 紋波電流
8200	822	18 x 16	0.048	1500						

μF	WV Code 代碼	25			35			50		
		1E			1V			1H		
4.7	4R7				4 x 5	1.35	90	5 x 5	1.52	85
10	100	4 x 5	1.35	90	5 x 5	0.76	160	6.3 x 5 (5 x 5)	0.88 (1.35)	165 (115)
15	150	5 x 5	0.76	160	5 x 5	0.76	160	6.3 x 5	0.88	165
22	220	6.3 x 5 (5 x 5)	0.44 (0.76)	240 (160)	6.3 x 5	0.44	240	6.3 x 7 (6.3 x 5)	0.68 (0.88)	195 (165)
33	330	6.3 x 5	0.44	240	6.3 x 5	0.44	240	6.3 x 7	0.68	195
47	470	6.3 x 7 (6.3 x 5)	0.34 (0.44)	300 (240)	6.3 x 7 (6.3 x 5)	0.34 (0.88)	300 (165)	8 x 10 (6.3 x 7)	0.34 (0.68)	350 (195)
56	560	6.3 x 7	0.34	300	6.3 x 7	0.34	300	8 x 10	0.34	350
68	680	6.3 x 7	0.34	300	8 x 10	0.17	600	8 x 10	0.34	350
100	101	8 x 10 (6.3 x 7)	0.17 (0.34)	600 (300)	8 x 10	0.17	600	10 x 10 (8 x 10)	0.18 (0.34)	670 (350)
150	151	8 x 10 (6.3 x 7)	0.16 (0.34)	600 (300)	10 x 10 (8 x 10)	0.09 (0.16)	850 (600)	10 x 13 (10 x 10)	0.14 (0.18)	780 (670)
220	221	8 x 10	0.17	600	10 x 10 (8 x 10)	0.09 (0.16)	850 (600)	10 x 13.5 (10 x 10.5)	0.14 (0.26)	780 (750)
330	331	10 x 10 (8 x 10)	0.09 (0.17)	850 (600)	10 x 13 (10 x 10)	0.07 (0.10)	950 (850)	12.5 x 13	0.12	900
470	471	10 x 13 (10 x 10)	0.07 (0.09)	950 (850)	12.5 x 13 (10 x 13) (10 x 10)	0.06 (0.07) (0.10)	1100 (1000) (950)	16 x 16 (12.5 x 16) (12.5 x 13)	0.08 (0.10) (0.08)	1250 (1050) (1100)
680	681	12.5 x 13	0.06	1100	12.5 x 16 (12.5 x 13)	0.055 (0.06)	1200 (1100)	16 x 16	0.073	1250
1000	102	16 x 16 (12.5 x 16) (12.5 x 13)	0.05 (0.055) (0.06)	1450 (1200) (1100)	16 x 16	0.05	1450	18 x 18 (16 x 16) (18 x 16)	0.073 (0.08) (0.073)	1250 (1000) (1250)
1500	152	16 x 16	0.05	1450	16 x 16	0.048	1500	Case size 尺寸	Impedance 阻抗值	Ripple current 紋波電流
2200	222	16 x 16	0.05	1450	18 x 18	0.038	1750			
3300	333	18 x 16 (18 x 18)	0.048 (0.048)	1500 (1500)						

•Case size 尺寸 ∅D×L(mm), Impedance 阻抗值 (Ω) at 20°C, 100KHz, Ripple current 紋波電流 (mA rms) at 105°C, 100KHz

Note: All design and specifications are for reference only and is subject to change without prior notice. If any doubt about safety for your application, please contact us immediately for technical assistance before purchase.

注：以上所提供的設計及特性參數僅供參考，任何修改不作預先通知。如果在使用上有疑問，請在採購前與我們聯繫，以便提供技術上的協助。

CAT.2023/V2

RZ Series New
新品

□ DIMENSIONS & MAXIMUM PERMISSIBLE RIPPLE CURRENT & IMPEDANCE 規格尺寸及最大允許紋波電流及阻抗值

WV Code 代碼	μF	63			80			100		
		1J			1K			2A		
3.3	3R3				5 × 5	5.0	25			
4.7	4R7	5 × 5	3.0	50	6.3 × 5	3.0	40			
10	100	6.3 × 7 (6.3 × 5)	1.2 (1.5)	120 (80)	6.3 × 7	2.4	60	8 × 10	1.3	130
22	220	8 × 10 (6.3 × 7)	0.65 (1.2)	250 (120)	8 × 10	1.3	130	10 × 10 (8 × 10)	0.7 (1.3)	200 (160)
33	330	8 × 10	0.65	250	10 × 10	0.7	200	10 × 13	0.7	200
47	470	10 × 10 (8 × 10)	0.5 (0.65)	300 (250)	10 × 13	0.45	300	12.5 × 13	0.32	500
68	680	12.5 × 13 (10 × 10)	0.16 (0.5)	800 (300)	12.5 × 13	0.32	500	12.5 × 13	0.32	500
100	101	12.5 × 13 (10 × 13) (10 × 10)	0.16 (0.25) (0.5)	800 (400) (300)	12.5 × 13 (10 × 13)	0.32 (0.18)	500 (750)	16 × 16 (12.5 × 16) (12.5 × 13)	0.17 (0.26) (0.32)	795 (550) (500)
150	151	12.5 × 13 (10 × 13)	0.16 (0.25)	800 (650)	12.5 × 13	0.32	500	16 × 16 (12.5 × 16)	0.17 (0.26)	650 (550)
220	221	12.5 × 13	0.16	800	12.5 × 16 (12.5 × 13)	0.26 (0.12)	550 (900)	18 × 16	0.15	850
330	331	16 × 16	0.082	900	16 × 16	0.17	795	18 × 16	0.15	850
470	471	16 × 16	0.082	900	18 × 16	0.15	850	18 × 18	0.15	950
680	681	18 × 16	0.08	1150	18 × 18	0.15	950	Case size 尺寸	Impedance 阻抗值	Ripple current 紋波電流
1000	102	18 × 18	0.06	1250						

•Case size 尺寸 $\varnothing D \times L$ (mm), Impedance 阻抗值 (Ω) at 20°C, 100KHz, Ripple current 紋波電流 (mA rms) at 105°C, 100KHz

□ FREQUENCY COEFFICIENT OF ALLOWABLE RIPPLE CURRENT 紋波電流頻率補償系數

Frequency 頻率		50Hz	120Hz	300Hz	1KHz	10KHz~	
Coefficient 系數	$\varnothing 4 \sim \varnothing 10$	4.7 ~ 68 μ F	0.35	0.50	0.64	0.83	1.00
		100 ~ 1500 μ F	0.40	0.55	0.70	0.85	1.00
	$\varnothing 12.5 \sim \varnothing 18$	~ 68 μ F	0.40	0.55	0.70	0.85	1.00
		100 ~ 680 μ F	0.45	0.65	0.80	0.90	1.00
		1000 ~ 4700 μ F	0.65	0.85	0.95	1.00	1.00

The endurance of capacitors is reduced with internal heating produced by ripple current at the rate of halving the lifetime with every 5~10°C rise. When long life performance is required in actual use, the rms ripple current has to be reduced. 鋁電解電容器在疊加紋波電流後會引起發熱，溫度每上升 5~10°C 壽命會減半。若要保持長壽命性能，請在使用過程中適當降低紋波電流。

- Taping specifications are given in page 17. 編帶標準請查閱第 17 頁。
- Soldering conditions and recommended land size are given in page 23. 焊接條件及推薦安裝尺寸請查閱第 23 頁。
- Please refer to page 18 for the minimum package quantity. 最小包裝數量請查閱第 18 頁。
- Please refer to page 15 for the Part Number System. 產品編碼規則請查閱第 15 頁。

Note: All design and specifications are for reference only and is subject to change without prior notice. If any doubt about safety for your application, please contact us immediately for technical assistance before purchase.

注：以上所提供的設計及特性參數僅供參考，任何修改不作預先通知。如果在使用上有疑問，請在採購前與我們聯繫，以便提供技術上的協助。

CAT.2023/V2

TL Series

EXTREMELY LOW IMPEDANCE, LONG LIFE

極低阻抗，長壽命品

- Endurance 4000~10000 hours
耐久性 4000~10000 小時
- Suitable for long life applications
適用於長壽命應用
- Comply with the RoHS & REACH
符合 RoHS 與 REACH

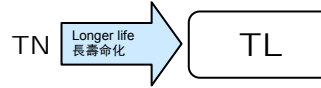
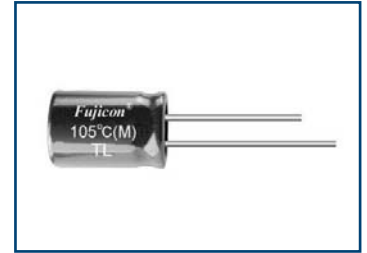

□ SPECIFICATIONS 特性表

Items 項目	Characteristics 主要特性																											
Category Temperature Range 工作溫度範圍	-40 ~ +105°C																											
Voltage Range 額定工作電壓範圍	6.3 ~ 100V																											
Capacitance Range 靜電容量範圍	0.47 ~ 18000μF																											
Capacitance Tolerance 靜電容量允許偏差	±20% at 120Hz, 20°C																											
Leakage Current 漏電流	Leakage current ≤0.01CV or 3μA, whichever is greater (after 2 minutes application of rated voltage at 20°C) 漏電流 ≤0.01CV 或 3μA, 取較大值 (在 20°C 環境中施加額定工作電壓 2 分鐘後) C: Nominal capacitance (μF) 標稱靜電容量, V: Rated voltage (V) 額定電壓																											
Dissipation Factor (tan δ) 損耗角正切	Measurement frequency 測試頻率: 120Hz, Temperature 溫度: 20°C <table border="1"> <thead> <tr> <th>Rated Voltage (V) 額定工作電壓</th> <th>6.3</th> <th>10</th> <th>16</th> <th>25</th> <th>35</th> <th>50</th> <th>63</th> <th>100</th> </tr> </thead> <tbody> <tr> <td>tan δ (max.) 最大損耗角正切</td> <td>0.22</td> <td>0.19</td> <td>0.16</td> <td>0.14</td> <td>0.12</td> <td>0.10</td> <td>0.09</td> <td>0.08</td> </tr> </tbody> </table>	Rated Voltage (V) 額定工作電壓	6.3	10	16	25	35	50	63	100	tan δ (max.) 最大損耗角正切	0.22	0.19	0.16	0.14	0.12	0.10	0.09	0.08									
Rated Voltage (V) 額定工作電壓	6.3	10	16	25	35	50	63	100																				
tan δ (max.) 最大損耗角正切	0.22	0.19	0.16	0.14	0.12	0.10	0.09	0.08																				
Stability at Low Temperature 低溫特性	Measurement frequency 測試頻率: 120Hz <table border="1"> <thead> <tr> <th>Rated Voltage (V) 額定工作電壓</th> <th>6.3</th> <th>10</th> <th>16</th> <th>25</th> <th>35</th> <th>50</th> <th>63</th> <th>100</th> </tr> </thead> <tbody> <tr> <td>Impedance Ratio 阻抗比</td> <td>Z(-25°C) / Z(20°C)</td> <td>4</td> <td>3</td> <td>2</td> <td>2</td> <td>2</td> <td>2</td> <td>2</td> </tr> <tr> <td></td> <td>Z(-40°C) / Z(20°C)</td> <td>8</td> <td>6</td> <td>4</td> <td>3</td> <td>3</td> <td>3</td> <td>3</td> </tr> </tbody> </table>	Rated Voltage (V) 額定工作電壓	6.3	10	16	25	35	50	63	100	Impedance Ratio 阻抗比	Z(-25°C) / Z(20°C)	4	3	2	2	2	2	2		Z(-40°C) / Z(20°C)	8	6	4	3	3	3	3
Rated Voltage (V) 額定工作電壓	6.3	10	16	25	35	50	63	100																				
Impedance Ratio 阻抗比	Z(-25°C) / Z(20°C)	4	3	2	2	2	2	2																				
	Z(-40°C) / Z(20°C)	8	6	4	3	3	3	3																				
Endurance 耐久性	The characteristics listed below shall be satisfied when the capacitors are restored to 20°C after subject to DC voltage with the rated ripple current is applied (the peak voltage shall not exceed the rated voltage) for the specified period of time at 105°C. 在 105°C 環境中的規定時間內施加額定紋波電流 (峰值電壓不得超過額定電壓) 後, 電容器經直流電壓後恢復至 20°C 時, 應符合下表參數要求。 <table border="1"> <thead> <tr> <th rowspan="2">Size (mm) 尺寸</th> <th colspan="2">Life time (hours) 壽命 (小時)</th> </tr> <tr> <th>6.3 ~ 10V</th> <th>16 ~ 100V</th> </tr> </thead> <tbody> <tr> <td>∅5, ∅6.3 (∅5×15)*</td> <td>4000</td> <td>5000*</td> </tr> <tr> <td>∅8, ∅10</td> <td>6000</td> <td>7000</td> </tr> <tr> <td>∅D≥13</td> <td>8000</td> <td>10000</td> </tr> </tbody> </table> <table border="1"> <tbody> <tr> <td>Capacitance Change 靜電容量變化率</td> <td>Within ±25% of initial measured value 初始值的±25%以內</td> </tr> <tr> <td>Dissipation Factor 損耗角正切</td> <td>≤200% of initial specified value 不大於規範值的 200%</td> </tr> <tr> <td>Leakage Current 漏電流</td> <td>≤initial specified value 不大於規範值</td> </tr> </tbody> </table>	Size (mm) 尺寸	Life time (hours) 壽命 (小時)		6.3 ~ 10V	16 ~ 100V	∅5, ∅6.3 (∅5×15)*	4000	5000*	∅8, ∅10	6000	7000	∅D≥13	8000	10000	Capacitance Change 靜電容量變化率	Within ±25% of initial measured value 初始值的±25%以內	Dissipation Factor 損耗角正切	≤200% of initial specified value 不大於規範值的 200%	Leakage Current 漏電流	≤initial specified value 不大於規範值							
Size (mm) 尺寸	Life time (hours) 壽命 (小時)																											
	6.3 ~ 10V	16 ~ 100V																										
∅5, ∅6.3 (∅5×15)*	4000	5000*																										
∅8, ∅10	6000	7000																										
∅D≥13	8000	10000																										
Capacitance Change 靜電容量變化率	Within ±25% of initial measured value 初始值的±25%以內																											
Dissipation Factor 損耗角正切	≤200% of initial specified value 不大於規範值的 200%																											
Leakage Current 漏電流	≤initial specified value 不大於規範值																											
Shelf Life 高溫貯存特性	After leaving capacitors under no load at 105°C for 1000 hours, they meet the specified value for load life characteristics listed above. 在 105°C 環境中無負荷放置 1000 小時後, 電容器的特性符合高溫負荷特性中所列的規定值。																											
Marking 標識	Printed with white colour on black sleeve (PVC) or printed with white colour on green sleeve (PET). 黑色膠管白字印刷 (PVC) 或綠色膠管白字印刷 (PET)。																											

□ DRAWING & DIMENSIONS 外形圖及尺寸 (Unit: mm)

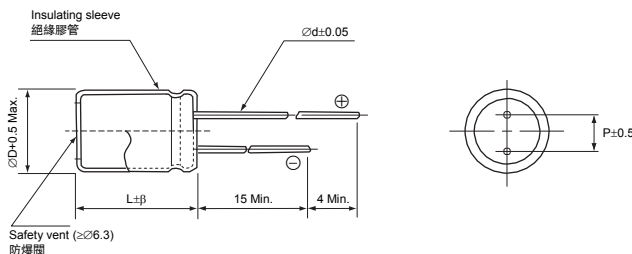

∅D	5	6.3	8 (L≤11.5)	8 (L≥16)	10	13	16	18
P	2.0	2.5	3.5		5.0	7.5		
∅d	0.5			0.6		0.8		
β	1.5				2.0			

□ FREQUENCY COEFFICIENT OF ALLOWABLE RIPPLE CURRENT 紋波電流頻率補償系數

Frequency 頻率	60Hz	120Hz	300Hz	1KHz	10KHz~	
Coefficient 系數	< 33μF	0.20	0.42	0.52	0.70	0.90
	39 ~ 270μF	0.26	0.50	0.55	0.73	0.92
	330 ~ 680μF	0.28	0.55	0.60	0.77	0.94
	820 ~ 1800μF	0.35	0.60	0.70	0.80	0.96
	2200 ~ 18000μF	0.42	0.70	0.77	0.85	0.98

The endurance of capacitors is reduced with internal heating produced by ripple current at the rate of halving the lifetime with every 5~10°C rise. When long life performance is required in actual use, the rms ripple current has to be reduced. 鋁電解電容器在疊加紋波電流後會引起發熱, 溫度每上升 5~10°C 壽命會減半。若要保持長壽命性能, 請在使用過程中適當降低紋波電流。

Note: All design and specifications are for reference only and is subject to change without prior notice. If any doubt about safety for your application, please contact us immediately for technical assistance before purchase.
注: 以上所提供的設計及特性參數僅供參考, 任何修改不作預先通知。如果在使用上有疑問, 請在採購前與我們聯繫, 以便提供技術上的協助。

CAT.2023/V2

TL Series

DIMENSIONS & MAXIMUM PERMISSIBLE RIPPLE CURRENT & IMPEDANCE 規格尺寸及最大允許紋波電流及阻抗值

WV Parameter 參數 μF		6.3 (0J)			10 (1A)			16 (1C)			25 (1E)		
		Case size ØD×L (mm) 尺寸	Impedance (Ω) max. 20°C, 100KHz 阻抗值	Ripple current 紋波電流 (mA rms, 105°C, 100KHz)	Case size ØD×L (mm) 尺寸	Impedance (Ω) max. 20°C, 100KHz 阻抗值	Ripple current 紋波電流 (mA rms, 105°C, 100KHz)	Case size ØD×L (mm) 尺寸	Impedance (Ω) max. 20°C, 100KHz 阻抗值	Ripple current 紋波電流 (mA rms, 105°C, 100KHz)	Case size ØD×L (mm) 尺寸	Impedance (Ω) max. 20°C, 100KHz 阻抗值	Ripple current 紋波電流 (mA rms, 105°C, 100KHz)
47	470									5 x 11 (5 x 15)	0.58 (0.55)	210 (230)	
56	560							5 x 11	0.58	210			
100	101				5 x 11 (5 x 15)	0.58 (0.52)	210 (230)	6.3 x 11.5	0.35	295	6.3 x 11.5	0.22	340
120	121							6.3 x 11.5	0.35	340			
150	151	5 x 11 (5 x 15)	0.58 (0.52)	210 (230)				6.3 x 11.5	0.22	340			
220	221				6.3 x 11.5	0.22	340	8 x 11.5	0.16	430	8 x 11.5 (10 x 12)	0.11 (0.10)	640 (735)
270	271										8 x 16	0.085	820
330	331	6.3 x 11.5	0.22	340				8 x 11.5	0.11	640	8 x 16 (10 x 12)	0.083 (0.080)	840 (865)
470	471				8 x 11.5	0.11	640	8 x 16 (10 x 12)	0.083 (0.080)	840 (865)	8 x 20 (10 x 16)	0.064 (0.060)	1050 (1210)
680	681	8 x 11.5	0.13	640	8 x 16 (10 x 12)	0.083 (0.080)	840 (865)	8 x 20 (10 x 16)	0.064 (0.060)	1050 (1210)	10 x 20 (13 x 21)	0.046 (0.049)	1400 (1450)
820	82	10 x 12	0.080	865							10 x 25	0.042	1650
1000	102	8 x 16	0.087	840	8 x 20 (10 x 16)	0.064 (0.060)	1050 (1210)	10 x 20 (13 x 21)	0.046 (0.049)	1400 (1450)	10 x 30 (13 x 21) (16 x 20)	0.031 (0.035) (0.042)	1910 (1900) (1940)
1200	122	8 x 20 (10 x 16)	0.069 (0.060)	1050 (1210)	10 x 20	0.046	1400	10 x 25	0.042	1650	13 x 25	0.043	2210
1500	152	13 x 21	0.046	1400	10 x 25 (13 x 21)	0.042 (0.049)	1650 (1450)	13 x 21	0.035	1900	13 x 25	0.027	2230
1800	182	13 x 21	0.049	1450							13 x 30 (16 x 25)	0.024 (0.027)	2650 (2530)
2200	222	13 x 21	0.042	1650	10 x 30 (13 x 21) (16 x 20)	0.031 (0.035) (0.042)	1910 (1900) (1940)	13 x 25 (18 x 20)	0.027 (0.043)	2230 (2210)	13 x 35 (16 x 25)	0.020 (0.026)	2880 (2860)
2700	272	13 x 25	0.042	1940	13 x 25	0.043	2210	13 x 30 (16 x 25)	0.024 (0.027)	2650 (2530)	16 x 25 (16 x 31)	0.026 (0.017)	2860 (3350)
3300	332	13 x 25	0.035	1900	13 x 25	0.027	2230	13 x 35	0.020	2880	16 x 35 (18 x 31)	0.017 (0.019)	3450 (3140)
3900	392	13 x 25 (18 x 16)	0.027 (0.043)	2230 (2210)	13 x 30 (16 x 25)	0.024 (0.027)	2650 (2530)	16 x 35 (18 x 31)	0.021 (0.026)	2930 (2860)	16 x 40 (18 x 31)	0.015 (0.015)	3610 (4170)
4700	472	13 x 30	0.024	2650	13 x 35	0.020	2880	16 x 35 (18 x 31)	0.017 (0.019)	3450 (3140)	16 x 40 (18 x 35)	0.013 (0.014)	4080 (4220)
5600	562	13 x 35 (16 x 20)	0.020 (0.027)	2880 (2530)	16 x 31 (18 x 25)	0.021 (0.026)	2930 (2860)	16 x 35 (18 x 31)	0.015 (0.015)	3610 (4170)	18 x 40	0.012	4280
6800	682	16 x 31 (18 x 25)	0.021 (0.026)	2930 (2860)	16 x 31 (18 x 25)	0.017 (0.019)	3450 (3140)	18 x 35	0.013	4080			
8200	822	16 x 31	0.017	3450	16 x 35 (18 x 31)	0.015 (0.015)	3610 (4170)	18 x 35	0.014	4220			
10000	103	16 x 35 (18 x 31)	0.015 (0.019)	3610 (3140)	16 x 40 (18 x 35)	0.013 (0.014)	4080 (4220)	18 x 40	0.012	4280			
12000	123	16 x 40 (18 x 31)	0.013 (0.015)	4080 (4170)	18 x 40	0.012	4280						
15000	153	18 x 35	0.014	4220									
18000	183	18 x 40	0.012	4280									

Note: All design and specifications are for reference only and is subject to change without prior notice. If any doubt about safety for your application, please contact us immediately for technical assistance before purchase.

注：以上所提供的設計及特性參數僅供參考，任何修改不作預先通知。如果在使用上有疑問，請在採購前與我們聯繫，以便提供技術上的協助。

CAT.2023/V2

TL Series

□ DIMENSIONS & MAXIMUM PERMISSIBLE RIPPLE CURRENT & IMPEDANCE 規格尺寸及最大允許紋波電流及阻抗值

WV		35 (1V)			50 (1H)			63 (1J)		
Parameter	參數	Case size ØDxL (mm) 尺寸	Impedance (Ω) max. 20°C, 100KHz 阻抗值	Ripple current 紋波電流 (mA rms, 105°C, 100KHz)	Case size ØDxL (mm) 尺寸	Impedance (Ω) max. 20°C, 100KHz 阻抗值	Ripple current 紋波電流 (mA rms, 105°C, 100KHz)	Case size ØDxL (mm) 尺寸	Impedance (Ω) max. 20°C, 100KHz 阻抗值	Ripple current 紋波電流 (mA rms, 105°C, 100KHz)
0.47	R47				5 x 11	7.2	17			
1	010				5 x 11 (5 x 15)	5.2 (5.0)	30 (33)			
2.2	2R2				5 x 11 (5 x 15)	3.3 (3.0)	43 (48)			
3.3	3R3				5 x 11 (5 x 15)	2.9 (2.6)	53 (56)			
4.7	4R7				5 x 11 (5 x 15)	2.5 (2.2)	95 (100)			
10	100				5 x 11 (6.3 x 11.5)	2.0 (2.0)	120 (130)			
15	150							6.3 x 11.5	1.2	165
22	220				6.3 x 11.5	0.91	180			
33	330	5 x 11 (5 x 15)	0.58 (0.55)	210 (235)	6.3 x 11.5	0.75	225	6.3 x 11.5	0.49	265
47	470	6.3 x 11.5	0.22	340	6.3 x 11.5 (8 x 11.5)	0.4 (0.39)	250 (295)			
56	560	6.3 x 11.5	0.22	340				8 x 11.5	0.31	500
82	820							8 x 16 (10 x 12)	0.22 (0.15)	665 (690)
100	101	6.3 x 11.5	0.20	450	10 x 12	0.22	555	10 x 12	0.15	690
120	121				10 x 16	0.154	730	8 x 20 (10 x 16)	0.17 (0.11)	820 (950)
150	151	8 x 11.5	0.11	640	10 x 16	0.16	760			
180	181	8 x 16	0.086	850	10 x 16	0.118	910	10 x 20 (13 x 21)	0.078 (0.101)	1150 (1150)
220	221	8 x 16 (10 x 12)	0.086 (0.080)	850 (865)	10 x 16 (10 x 20)	0.11 (0.11)	980 (1050)	10 x 25	0.064	1350
270	271	8 x 20	0.064	1050	10 x 20 (13 x 21)	0.078 (0.079)	1220 (1260)	13 x 21	0.057	1500
330	331	10 x 16	0.060	1210	10 x 25	0.072	1440			
390	391							13 x 25	0.043	1900
470	471	10 x 20 (13 x 21)	0.046 (0.049)	1400 (1450)	13 x 21 (16 x 20)	0.059 (0.072)	1660 (1690)	13 x 30 (16 x 25)	0.039 (0.045)	2300 (2000)
560	561	13 x 21	0.042	1650	13 x 25 (16 x 20)	0.044 (0.070)	1950 (1930)	13 x 35	0.034	2500
680	681	13 x 21 (16 x 20)	0.035 (0.042)	1900 (1940)	13 x 30	0.039	2310	16 x 31	0.035	2600
820	821				13 x 35 (16 x 20)	0.033 (0.044)	2510 (2210)	16 x 31 (18 x 25)	0.029 (0.034)	2850 (2800)
1000	102	16 x 25 (18 x 20)	0.027 (0.043)	2230 (2210)	13 x 40 (16 x 25) (18 x 20)	0.027 (0.033) (0.047)	2920 (2555) (2490)	16 x 35	0.027	2900
1200	122	13 x 30 (16 x 20)	0.024 (0.027)	2650 (2530)	16 x 31 (18 x 25)	0.027 (0.028)	3010 (2740)	16 x 40 (18 x 31)	0.025 (0.028)	3400 (3300)
1500	152	13 x 35	0.020	2880	16 x 35	0.024	3150	18 x 35	0.025	3400
1800	182	16 x 31 (18 x 25)	0.021 (0.026)	2930 (2860)	16 x 40 (18 x 31)	0.021 (0.024)	3710 (3635)	18 x 40	0.024	3500
2200	222	16 x 35 (18 x 31)	0.016 (0.019)	3500 (3140)	18 x 35 (18 x 40)	0.022 (0.020)	3680 (3750)			
2700	272	16 x 40 (18 x 35)	0.015 (0.015)	3610 (4170)	18 x 40	0.018	3800			
3300	332	16 x 40 (18 x 35)	0.013 (0.014)	4080 (4220)						

WV		100 (2A)		
Parameter	參數	Case size ØDxL (mm) 尺寸	Impedance (Ω) max. 20°C, 100KHz 阻抗值	Ripple current 紋波電流 (mA rms, 105°C, 100KHz)
47	470	10 x 16	0.28	680

- Please refer to page 19 "Taping Specifications" & page 21 "Lead Forming & Cutting" about the taped or formed product spec. 編帶與引線成型標準請查閱第 19 頁“編帶標準”及第 21 頁“引線成型與剪腳”。
- Please refer to page 20 "Packaging Specifications" for the minimum package quantity. 最小包裝數量請查閱第 20 頁“包裝標準”。
- Please refer to page 16 for the Part Number System. 產品編碼規則請查閱第 16 頁。

Note: All design and specifications are for reference only and is subject to change without prior notice. If any doubt about safety for your application, please contact us immediately for technical assistance before purchase.
注: 以上所提供的設計及特性參數僅供參考，任何修改不作預先通知。如果在使用上有疑問，請在採購前與我們聯繫，以便提供技術上的協助。

CAT.2023/V2

TW Series

HIGH TEMPERATURE, FOR 125°C USE

125°C 高温品

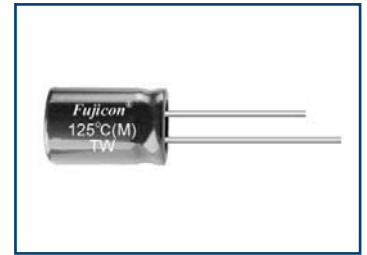

- Low impedance at high frequency
高頻低阻抗
- For electronic control units and other high temperature applications
適用於電子控制器與其他高溫應用
- Endurance 2000 hours at 125°C
在 125°C 環境中耐久性 2000 小時
- Comply with the RoHS & REACH
符合 RoHS 與 REACH

□ SPECIFICATIONS 特性表

Items 項目	Characteristics 主要特性	
Category Temperature Range 工作溫度範圍	-40 ~ +125°C	
Voltage Range 額定工作電壓範圍	6.3 ~ 50V	63 ~ 250V
Capacitance Range 靜電容量範圍	1 ~ 15000µF	0.47 ~ 100µF
Capacitance Tolerance 靜電容量允許偏差	±20% at 120Hz, 20°C	
Leakage Current 漏電流	Leakage current ≤0.01CV or 3µA, whichever is greater (after 2 minutes application of rated voltage at 20°C) 漏電流 ≤0.01CV 或 3µA 取較大值(在 20°C 環境中施加額定工作電壓 2 分鐘後)	Leakage current ≤0.02CV + 15µA (after 5 minutes application of rated voltage at 20°C) 漏電流 ≤0.02CV + 15µA(在 20°C 環境中施加額定工作電壓 5 分鐘後)
Dissipation Factor (tan δ) 損耗角正切	C: Nominal capacitance (µF) 標稱靜電容量, V: Rated voltage (V) 額定電壓 When nominal capacitance is over 1000µF, tan δ shall be added 0.02 to the listed value with increase of every 1000µF. 當標稱靜電容量大於 1000µF, 其標稱靜電容量每增加 1000µF, 損耗角正切增加 0.02. Measurement frequency 測試頻率: 120Hz, Temperature 溫度: 20°C	
Stability at Low Temperature 低溫特性	Rated Voltage (V) 額定工作電壓	6.3 10 16 25 35 50 63~100 160~250
	tan δ (max.) 最大損耗角正切	0.22 0.19 0.16 0.14 0.12 0.10 0.08 0.15
Endurance 耐久性	After 2000 hours application of the rated voltage at 125°C, they meet the characteristics listed below. (∅5, ∅6.3 and WV≥100 products are for 1000 hours) 在 125°C 環境中施加額定工作電壓 2000 小時後, 電容器的特性符合下表的要求 (∅5, ∅6.3 和 WV≥100 產品為 1000 小時)。	
	Capacitance Change 靜電容量變化率	Within ±20% of initial measured value 初始值的±20%以內
Shelf Life 高溫貯存特性	Dissipation Factor 損耗角正切	≤300% of initial specified value 不大於規範值的 300%
	Leakage Current 漏電流	≤initial specified value 不大於規範值
Marking 標識	Printed with white colour on black sleeve (PVC) or printed with white colour on green sleeve (PET). 黑色膠管白字印刷 (PVC) 或綠色膠管白字印刷 (PET)。	

□ DRAWING & DIMENSIONS 外形圖及尺寸 (Unit: mm)

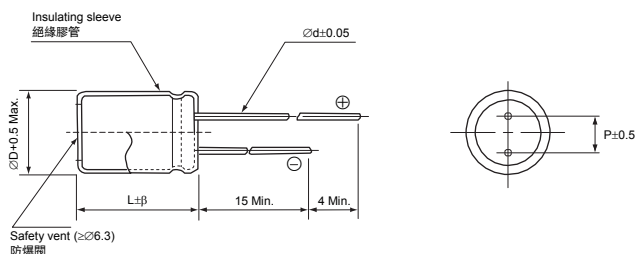

∅D	5	6.3	8 (L≤11.5)	8 (L≥16)	10	13	16	18
P	2.0	2.5	3.5		5.0	7.5		
∅d	0.5		0.6			0.8		
β	1.5				2.0			

□ FREQUENCY COEFFICIENT OF ALLOWABLE RIPPLE CURRENT 紋波電流頻率補償係數

Frequency 頻率	120Hz	300Hz	1KHz	10KHz	100KHz
Cap.(µF) 容量					
1000 > CV	0.50	0.64	0.83	0.90	1.0
1000 ≤ CV	0.67	0.79	0.91	0.95	1.0

The endurance of capacitors is reduced with internal heating produced by ripple current at the rate of halving the lifetime with every 5~10°C rise. When long life performance is required in actual use, the rms ripple current has to be reduced. 鋁電解電容器在疊加紋波電流後會引起發熱, 溫度每上升 5~10°C 壽命會減半。若要保持長壽命性能, 請在使用過程中適當降低紋波電流。

Note: All design and specifications are for reference only and is subject to change without prior notice. If any doubt about safety for your application, please contact us immediately for technical assistance before purchase.
注: 以上所提供的設計及特性參數僅供參考, 任何修改不作預先通知。如果在使用上有疑問, 請在採購前與我們聯繫, 以便提供技術上的協助。

CAT.2023/V2

TW Series

DIMENSIONS & MAXIMUM PERMISSIBLE RIPPLE CURRENT & IMPEDANCE 規格尺寸及最大允許紋波電流及阻抗值

WV		6.3 (0J)			10 (1A)			16 (1C)		
Parameter 參數 μF	Case size ØD×L (mm) 尺寸	Impedance (Ω) max. 20°C, 100KHz 阻抗值	Ripple current (mA rms) 125°C, 100KHz 紋波電流	Case size ØD×L (mm) 尺寸	Impedance (Ω) max. 20°C, 100KHz 阻抗值	Ripple current (mA rms) 125°C, 100KHz 紋波電流	Case size ØD×L (mm) 尺寸	Impedance (Ω) max. 20°C, 100KHz 阻抗值	Ripple current (mA rms) 125°C, 100KHz 紋波電流	
										Parameter 參數
47	470						5 × 11	1.0	24	
68	680			5 × 11	1.0	124	6.3 × 11.5	0.65	176	
100	101	5 × 11	1.1	120	63. × 11.5	0.71	168	6.3 × 11.5	0.45	212
150	151	6.3 × 11.5	0.64	180	6.3 × 11.5	0.45	212	8 × 11.5	0.30	310
220	221	6.3 × 11.5	0.39	228	8 × 11.5	0.31	310	8 × 11.5	0.21	368
330	331	8 × 11.5	0.26	234	8 × 11.5	0.21	368	10 × 12.5	0.16	500
470	471	10 × 12.5	0.18	460	10 × 12.5	0.17	480	10 × 16	0.12	616
680	681	10 × 16	0.14	560	10 × 16	0.12	616	10 × 20	0.085	816
1000	102	10 × 20	0.097	760	10 × 20	0.078	848	13 × 21	0.061	1129
1500	152	10 × 25	0.071	976	13 × 21	0.059	1134	13 × 25	0.047	1328
2200	222	13 × 21	0.056	1150	13 × 25	0.044	1368	16 × 20	0.043	1440
3300	332	13 × 25	0.044	1368	16 × 20	0.040	1480	16 × 25	0.035	1676
4700	472	16 × 25	0.042	1548	16 × 31.5	0.030	1936	16 × 35.5	0.026	2144
6800	682	16 × 31.5	0.031	1896	16 × 35.5	0.026	2144	18 × 35.5	0.023	2320
10000	103	16 × 40	0.026	2200	18 × 40	0.022	2432			
15000	153	18 × 40	0.023	2368						

WV		25 (1E)			35 (1V)			50 (1H)		
Parameter 參數 μF	Case size ØD×L (mm) 尺寸	Impedance (Ω) max. 20°C, 100KHz 阻抗值	Ripple current (mA rms) 125°C, 100KHz 紋波電流	Case size ØD×L (mm) 尺寸	Impedance (Ω) max. 20°C, 100KHz 阻抗值	Ripple current (mA rms) 125°C, 100KHz 紋波電流	Case size ØD×L (mm) 尺寸	Impedance (Ω) max. 20°C, 100KHz 阻抗值	Ripple current (mA rms) 125°C, 100KHz 紋波電流	
										Parameter 參數
1	010						5 × 11	5.2	29	
1.5	1R5						5 × 11	4.9	36	
2.2	2R2						5 × 11	4.5	43	
3.3	3R3						5 × 11	3.9	53	
4.7	4R7						5 × 11	2.9	65	
6.8	6R8						5 × 11	2.3	73	
10	100						5 × 11	1.8	92	
15	150						5 × 11	1.2	116	
22	220			5 × 11	0.97	128	6.3 × 11.5	0.84	156	
33	330	5 × 11	1.0	124	6.3 × 11.5	0.64	180	6.3 × 11.5	0.56	192
47	470	6.3 × 11.5	0.72	168	6.3 × 11.5	0.44	216	8 × 11.5	0.39	275
68	680	6.3 × 11.5	0.47	208	8 × 11.5	0.31	307	8 × 11.5	0.26	328
100	101	8 × 11.5	0.31	306	8 × 11.5	0.21	368	10 × 16	0.21	465
150	151	8 × 11.5	0.21	368	10 × 12.5	0.16	500	10 × 20	0.13	656
220	221	10 × 12.5	0.17	480	10 × 16	0.12	616	10 × 25	0.098	832
330	331	10 × 16	0.12	600	10 × 20	0.078	848	13 × 21	0.072	1025
470	471	10 × 20	0.084	816	13 × 21	0.060	1121	13 × 25	0.057	1200
680	681	13 × 21	0.060	1114	13 × 25	0.047	1328	16 × 20	0.052	1304
1000	102	13 × 25	0.047	1328	16 × 20	0.044	1416	16 × 31.5	0.039	1696
1500	152	16 × 20	0.044	1416	16 × 31.5	0.036	1908	16 × 40	0.034	1928
2200	222	16 × 25	0.036	1641	16 × 35.5	0.026	2144	18 × 40	0.031	2048
3300	332	16 × 35.5	0.026	2144	18 × 40	0.022	2432			
4700	472	18 × 40	0.023	2368						

Note: All design and specifications are for reference only and is subject to change without prior notice. If any doubt about safety for your application, please contact us immediately for technical assistance before purchase.

注：以上所提供的設計及特性參數僅供參考，任何修改不作預先通知。如果在使用上有疑問，請在採購前與我們聯繫，以便提供技術上的協助。

CAT.2023/V2

TW Series

□ DIMENSIONS & MAXIMUM PERMISSIBLE RIPPLE CURRENT & IMPEDANCE 規格尺寸及最大允許紋波電流及阻抗值

WV		63 (1J)		100 (2A)		160 (2C)	
Parameter 參數		Case size ØD×L (mm) 尺寸	Ripple current (mA rms) 125°C, 100KHz 紋波電流	Case size ØD×L (mm) 尺寸	Ripple current (mA rms) 125°C, 100KHz 紋波電流	Case size ØD×L (mm) 尺寸	Ripple current (mA rms) 125°C, 100KHz 紋波電流
0.47	R47	8 × 11.5	13	8 × 11.5	13	10 × 12.5	10
1	010	8 × 11.5	19	8 × 11.5	19	10 × 12.5	15
2.2	2R2	8 × 11.5	28	10 × 12.5	33	10 × 16	24
3.3	3R3	8 × 11.5	34	10 × 16	44	10 × 16	32
4.7	4R7	8 × 11.5	41	10 × 16	52	10 × 20	38
10	100	8 × 11.5	61	10 × 20	83	13 × 21	66
22	220	10 × 16	113	13 × 25	157	16 × 25	118
33	330	10 × 20	151	16 × 25	214	16 × 31.5	158
47	470	13 × 21	211	16 × 31.5	279		
100	101	13 × 25	336				

WV		200 (2D)		250 (2E)	
Parameter 參數		Case size ØD×L (mm) 尺寸	Ripple current (mA rms) 125°C, 100KHz 紋波電流	Case size ØD×L (mm) 尺寸	Ripple current (mA rms) 125°C, 100KHz 紋波電流
0.47	R47	10 × 12.5	10	10 × 12.5	10
1	010	10 × 12.5	15	10 × 12.5	14
2.2	2R2	10 × 16	24	10 × 16	24
3.3	3R3	10 × 20	32	10 × 20	32
4.7	4R7	10 × 20	38	13 × 21	45
10	100	13 × 21	72	16 × 25	79
22	220	16 × 31.5	129		

- Please refer to page 19 "Taping Specifications" & page 21 "Lead Forming & Cutting" about the taped or formed product spec. 編帶與引線成型標準請查閱第 19 頁 "編帶標準" 及第 21 頁 "引線成型與剪腳"。
- Please refer to page 20 "Packaging Specifications" for the minimum package quantity. 最小包裝數量請查閱第 20 頁 "包裝標準"。
- Please refer to page 16 for the Part Number System. 產品編碼規則請查閱第 16 頁。

Note: All design and specifications are for reference only and is subject to change without prior notice. If any doubt about safety for your application, please contact us immediately for technical assistance before purchase.

注：以上所提供的設計及特性參數僅供參考，任何修改不作預先通知。如果在使用上有疑問，請在採購前與我們聯繫，以便提供技術上的協助。

CAT.2023/V2

TY Series

HIGH RIPPLE CURRENT, HIGH RELIABILITY

高紋波電流，高可靠品

- High frequency, high ripple current and low impedance
高頻、高紋波電流和低阻抗
- Endurance 2000~7000 hours
耐久性 2000~7000 小時
- Comply with the RoHS & REACH
符合 RoHS 與 REACH

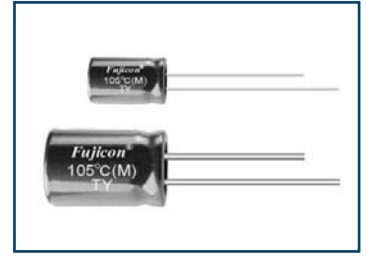

SPECIFICATIONS 特性表

Items 項目	Characteristics 主要特性																	
Category Temperature Range 工作溫度範圍	-40 ~ +105°C																	
Voltage Range 額定工作電壓範圍	6.3 ~ 50V																	
Capacitance Range 靜電容量範圍	22 ~ 18000µF																	
Capacitance Tolerance 靜電容量允許偏差	±20% at 120Hz, 20°C																	
Leakage Current 漏電流	Leakage current ≤0.01CV or 3µA, whichever is greater (after 2 minutes application of rated voltage at 20°C) 漏電流 ≤0.01CV 或 3µA, 取較大值 (在 20°C 環境中施加額定工作電壓 2 分鐘後) C: Nominal capacitance (µF) 標稱靜電容量, V: Rated voltage (V) 額定電壓																	
Dissipation Factor (tan δ) 損耗角正切	When nominal capacitance is over 1000µF, tan δ shall be added 0.02 to the listed value with increase of every 1000µF. 當標稱靜電容量大於 1000µF, 其標稱靜電容量每增加 1000µF, 損耗角正切增加 0.02. Measurement frequency 測試頻率: 120Hz, Temperature 溫度: 20°C																	
	<table border="1"> <thead> <tr> <th>Rated Voltage (V) 額定工作電壓</th> <th>6.3</th> <th>10</th> <th>16</th> <th>25</th> <th>35</th> <th>50</th> </tr> </thead> <tbody> <tr> <td>tan δ (max.) 最大損耗角正切</td> <td>0.22</td> <td>0.19</td> <td>0.16</td> <td>0.14</td> <td>0.12</td> <td>0.10</td> </tr> </tbody> </table>	Rated Voltage (V) 額定工作電壓	6.3	10	16	25	35	50	tan δ (max.) 最大損耗角正切	0.22	0.19	0.16	0.14	0.12	0.10			
Rated Voltage (V) 額定工作電壓	6.3	10	16	25	35	50												
tan δ (max.) 最大損耗角正切	0.22	0.19	0.16	0.14	0.12	0.10												
Stability at Low Temperature 低溫特性	Measurement frequency 測試頻率: 120Hz																	
	<table border="1"> <thead> <tr> <th colspan="2">Rated Voltage (V) 額定工作電壓</th> <th>6.3</th> <th>10</th> <th>16</th> <th>25~50</th> </tr> </thead> <tbody> <tr> <td>Impedance Ratio Z(-25°C) / Z(20°C) 阻抗比</td> <td></td> <td>4</td> <td>3</td> <td>2</td> <td>2</td> </tr> <tr> <td></td> <td>Z(-40°C) / Z(20°C)</td> <td>8</td> <td>6</td> <td>4</td> <td>3</td> </tr> </tbody> </table>	Rated Voltage (V) 額定工作電壓		6.3	10	16	25~50	Impedance Ratio Z(-25°C) / Z(20°C) 阻抗比		4	3	2	2		Z(-40°C) / Z(20°C)	8	6	4
Rated Voltage (V) 額定工作電壓		6.3	10	16	25~50													
Impedance Ratio Z(-25°C) / Z(20°C) 阻抗比		4	3	2	2													
	Z(-40°C) / Z(20°C)	8	6	4	3													
Endurance 耐久性	The characteristics listed below shall be satisfied when the capacitors are restored to 20°C after subject to DC voltage with the rated ripple current is applied (the peak voltage shall not exceed the rated voltage) for the specified period of time at 105°C. 在 105°C 環境中的規定時間內施加額定紋波電流 (峰值電壓不得超過額定電壓) 後, 電容器經直流電壓後恢復至 20°C 時, 應符合下表參數要求。																	
	<table border="1"> <thead> <tr> <th rowspan="2">Size (mm) 尺寸</th> <th colspan="2">Life time (hours) 壽命 (小時)</th> </tr> <tr> <th>6.3~10V</th> <th>16~50V</th> </tr> </thead> <tbody> <tr> <td>∅5, ∅6.3</td> <td>2000</td> <td>3000</td> </tr> <tr> <td>∅8, ∅10</td> <td>4000</td> <td>5000</td> </tr> <tr> <td>∅D≥13</td> <td>6000</td> <td>7000</td> </tr> </tbody> </table>	Size (mm) 尺寸	Life time (hours) 壽命 (小時)		6.3~10V	16~50V	∅5, ∅6.3	2000	3000	∅8, ∅10	4000	5000	∅D≥13	6000	7000			
	Size (mm) 尺寸		Life time (hours) 壽命 (小時)															
		6.3~10V	16~50V															
	∅5, ∅6.3	2000	3000															
∅8, ∅10	4000	5000																
∅D≥13	6000	7000																
Capacitance Change 靜電容量變化率	Within ±25% of initial measured value 初始值的±25%以內																	
Dissipation Factor 損耗角正切	≤200% of initial specified value 不大於規範值的 200%																	
Leakage Current 漏電流	≤initial specified value 不大於規範值																	
Shelf Life 高溫貯存特性	After leaving capacitors under no load at 105°C for 1000 hours, they meet the specified value for load life characteristics listed above 在 105°C 環境中無負荷放置 1000 小時後, 電容器的特性符合高溫負荷特性中所列的規定值。																	
Marking 標識	Printed with white colour on black sleeve (PVC) or printed with white colour on green sleeve (PET). 黑色膠管白字印刷 (PVC) 或綠色膠管白字印刷 (PET)。																	

DRAWING & DIMENSIONS 外形圖及尺寸 (Unit: mm)

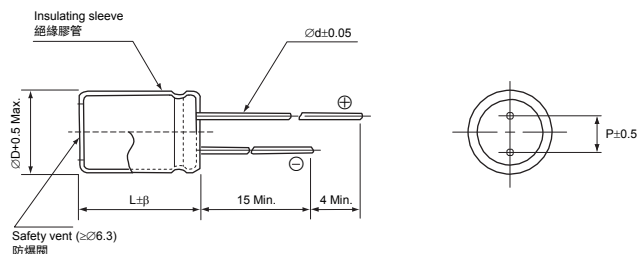

∅D	5	6.3	8 (L≤11.5)	8 (L≤16)	10	13	16	18
P	2.0	2.5	3.5		5.0	7.5		
∅d	0.5			0.6		0.8		
β	1.5					2.0		

FREQUENCY COEFFICIENT OF ALLOWABLE RIPPLE CURRENT 紋波電流頻率補償系數

Frequency 頻率	120Hz	1KHz	10KHz	100KHz	
Coefficient 系數	22 ~ 180µF	0.40	0.75	0.90	1.0
	220 ~ 560µF	0.50	0.85	0.94	1.0
	680 ~ 1800µF	0.60	0.87	0.95	1.0
	2200 ~ 3900µF	0.75	0.90	0.95	1.0
	4700 ~ 18000µF	0.85	0.95	0.98	1.0

The endurance of capacitors is reduced with internal heating produced by ripple current at the rate of halving the lifetime with every 5~10°C rise. When long life performance is required in actual use, the rms ripple current has to be reduced. 鋁電解電容器在疊加紋波電流後會引起發熱, 溫度每上升 5~10°C 壽命會減半。若要保持長壽命性能, 請在使用過程中適當降低紋波電流。

Note: All design and specifications are for reference only and is subject to change without prior notice. If any doubt about safety for your application, please contact us immediately for technical assistance before purchase.
注: 以上所提供的設計及特性參數僅供參考, 任何修改不作預先通知。如果在使用上有疑問, 請在採購前與我們聯繫, 以便提供技術上的協助。

CAT.2023/V2

TY Series

□ DIMENSIONS & MAXIMUM PERMISSIBLE RIPPLE CURRENT & IMPEDANCE 規格尺寸及最大允許紋波電流及阻抗值

Case size ØD×L (mm) 尺寸	WV Items 項目	6.3 (0J)					10 (1A)					16 (1C)				
		Capacitance (µF) 靜電容量		Impedance (Ω) max. 阻抗值		Ripple current 紋波電流 (mA rms, 105°C, 100KHz)	Capacitance (µF) 靜電容量		Impedance (Ω) max. 阻抗值		Ripple current 紋波電流 (mA rms, 105°C, 100KHz)	Capacitance (µF) 靜電容量		Impedance (Ω) max. 阻抗值		Ripple current 紋波電流 (mA rms, 105°C, 100KHz)
				20°C, 100KHz	-10°C, 100KHz				20°C, 100KHz	-10°C, 100KHz				20°C, 100KHz	-10°C, 100KHz	
5 × 11		150	151	1.16	4.6	215	100	101	1.16	4.6	215	56	560	1.16	4.6	215
6.3 × 11.5		330	331	0.44	1.74	345	220	221	0.44	1.74	345	120	121	0.44	1.74	345
8 × 11.5		680	681	0.26	1.04	645	470	471	0.26	1.04	645	330	331	0.26	1.04	645
10 × 12		820	820	0.16	0.64	870	680	681	0.16	0.064	870	470	471	0.174	0.70	845
10 × 16		1200	122	0.12	0.48	1215	1000	102	0.12	0.480	1215	680	681	0.138	0.54	1055
10 × 20		1500	152	0.092	0.36	1410	1200	122	0.092	0.360	1410	1000	102	0.092	0.36	1410
10 × 25		2200	222	0.084	0.34	1655	1500	152	0.084	0.340	1655	1200	122	0.084	0.34	1655
10 × 30		2700	272	0.062	0.24	1915	2200	222	0.062	0.240	1915	1500	152	0.062	0.24	1915
13 × 21		3300	332	0.070	0.24	1905	2200	222	0.070	0.120	1905	1500	152	0.070	0.24	1905
13 × 25		3900	392	0.054	0.178	2235	3300	332	0.054	0.178	2235	2200	222	0.054	0.178	2235
13 × 30		4700	472	0.048	0.156	2655	3900	392	0.048	0.156	2655	2700	272	0.048	0.156	2655
13 × 35		5600	562	0.040	0.130	2885	4700	472	0.040	0.130	2885	3300	332	0.040	0.130	2885
16 × 20		5600	562	0.054	0.156	2535	3900	392	0.054	0.156	2535	2700	272	0.054	0.140	2535
16 × 25		6800	682	0.042	0.120	2935	5600	562	0.042	0.120	2935	3900	392	0.042	0.120	2935
16 × 31		8200	822	0.034	0.100	3455	6800	682	0.034	0.100	3455	4700	472	0.034	0.100	3455
16 × 35		10000	103	0.030	0.088	3615	8200	822	0.030	0.088	3615	5600	562	0.030	0.088	3615
16 × 40		12000	123	0.026	0.076	4085	10000	103	0.026	0.076	4085	6800	682	0.026	0.076	4085
18 × 20		6800	682	0.052	0.134	2865	5600	562	0.052	0.134	2865	3900	392	0.052	0.134	2865
18 × 25		10000	103	0.038	0.098	3145	6800	682	0.038	0.098	3145	4700	472	0.038	0.049	3145
18 × 31		12000	123	0.030	0.080	4175	8200	822	0.030	0.080	4175	5600	562	0.030	0.040	4175
18 × 35		15000	153	0.028	0.076	4225	10000	103	0.028	0.076	4225	8200	822	0.028	0.038	4225
18 × 40		18000	183	0.024	0.064	4285	12000	123	0.024	0.064	4285	10000	103	0.024	0.032	4285

Case size ØD×L (mm) 尺寸	WV Items 項目	25 (1E)					35 (1V)					50 (1H)				
		Capacitance (µF) 靜電容量		Impedance (Ω) max. 阻抗值		Ripple current 紋波電流 (mA rms, 105°C, 100KHz)	Capacitance (µF) 靜電容量		Impedance (Ω) max. 阻抗值		Ripple current 紋波電流 (mA rms, 105°C, 100KHz)	Capacitance (µF) 靜電容量		Impedance (Ω) max. 阻抗值		Ripple current 紋波電流 (mA rms, 105°C, 100KHz)
				20°C, 100KHz	-10°C, 100KHz				20°C, 100KHz	-10°C, 100KHz				20°C, 100KHz	-10°C, 100KHz	
5 × 11		47	470	1.16	4.6	215	33	330	1.16	2.3	215	22	220	1.4	5.6	185
6.3 × 11.5		100	101	0.44	1.74	345	56	560	0.44	1.74	345	56	560	0.6	2.4	300
8 × 11.5		220	221	0.26	1.04	645	150	151	0.26	1.04	645	100	101	0.34	1.36	560
10 × 12		330	331	0.160	0.64	870	220	221	0.160	0.64	865	150	151	0.24	0.96	785
10 × 16		470	471	0.120	0.48	1215	330	331	0.100	0.48	1215	220	221	0.168	0.68	1055
10 × 20		680	681	0.092	0.36	1410	470	471	0.080	0.36	1410	270	271	0.110	0.48	1225
10 × 25		820	821	0.084	0.34	1655	560	561	0.084	0.34	1655	330	331	0.090	0.44	1445
10 × 30		1000	102	0.062	0.24	1915	680	681	0.062	0.24	1915	470	471	0.086	0.34	1695
13 × 21		1000	102	0.070	0.24	1905	680	681	0.070	0.24	1905	470	471	0.090	0.30	1665
13 × 25		1500	152	0.054	0.178	2235	1000	102	0.054	0.178	2235	560	561	0.070	0.22	1955
13 × 30		1800	182	0.048	0.156	2650	1200	122	0.048	0.156	2655	680	681	0.068	0.20	2315
13 × 35		2200	222	0.040	0.130	2885	1500	152	0.040	0.130	2885	820	821	0.070	0.20	2515
16 × 20		1800	182	0.054	0.156	2535	1200	122	0.054	0.156	2535	820	821	0.068	0.166	2215
16 × 25		2700	272	0.042	0.120	2935	1800	182	0.042	0.120	2935	1000	102	0.050	0.150	2560
16 × 31		3300	332	0.034	0.100	3455	2200	222	0.034	0.100	3455	1200	122	0.044	0.132	3015
16 × 35		3900	392	0.030	0.088	3615	2700	272	0.030	0.088	3615	1500	152	0.038	0.114	3155
16 × 40		4700	472	0.026	0.076	4085	3300	332	0.026	0.076	4085	1800	182	0.032	0.960	2715
18 × 20		2200	222	0.052	0.134	2865	1800	182	0.052	0.134	2865	1000	102	0.072	0.194	2495
18 × 25		3300	332	0.038	0.098	3145	2200	222	0.038	0.098	3145	1200	122	0.052	0.140	2745
18 × 31		3900	392	0.030	0.080	4175	2700	272	0.030	0.080	4175	1800	182	0.042	0.114	3640
18 × 35		4700	472	0.028	0.076	4225	3300	332	0.028	0.076	4225	2200	222	0.034	0.092	3685
18 × 40		5600	562	0.024	0.064	4285	3900	392	0.024	0.064	4285	2700	272	0.028	0.076	3805

- Please refer to page 19 "Taping Specifications" & page 21 "Lead Forming & Cutting" about the taped or formed product spec. 編帶與引線成型標準請查閱第 19 頁 "編帶標準" 及第 21 頁 "引線成型與剪腳"。
- Please refer to page 20 "Packaging Specifications" for the minimum package quantity. 最小包裝數量請查閱第 20 頁 "包裝標準"。
- Please refer to page 16 for the Part Number System. 產品編碼規則請查閱第 16 頁。

Note: All design and specifications are for reference only and is subject to change without prior notice. If any doubt about safety for your application, please contact us immediately for technical assistance before purchase.
 注：以上所提供的設計及特性參數僅供參考，任何修改不作預先通知。如果在使用上有疑問，請在採購前與我們聯繫，以便提供技術上的協助。

CAT.2023/V2

TB Series

HIGH RIPPLE CURRENT

高紋波電流品

- High ripple current
高紋波電流特性
- Endurance 2000~5000 hours
耐久性 2000~5000 小時
- Suitable for electronic ballast, power supply and LED lighting
適用於電子鎮流器，電源和 LED 照明
- Comply with the RoHS & REACH
符合 RoHS 與 REACH

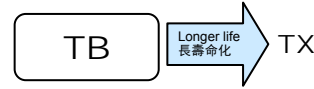
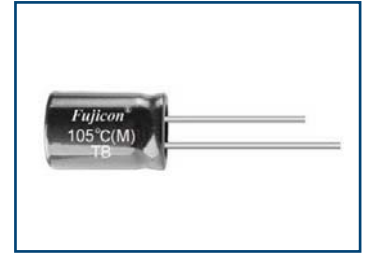

SPECIFICATIONS 特性表

Items 項目	Characteristics 主要特性														
Category Temperature Range 工作溫度範圍	-25 ~ +105°C														
Voltage Range 額定工作電壓範圍	160 ~ 450V														
Capacitance Range 靜電容量範圍	2.2 ~ 100μF														
Capacitance Tolerance 靜電容量允許偏差	±20% at 120Hz, 20°C														
Leakage Current 漏電流	Leakage current ≤0.02CV + 25μA (after 5 minutes application of rated voltage at 20°C) or Leakage current ≤0.04CV + 100μA (after 1 minute application of rated voltage at 20°C) 漏電流 ≤0.02CV + 25μA (在 20°C 環境中施加額定工作電壓 5 分鐘後) 或 漏電流 ≤0.04CV + 100μA (在 20°C 環境中施加額定工作電壓 1 分鐘後) C: Nominal capacitance (μF) 標稱靜電容量, V: Rated voltage (V) 額定電壓														
Dissipation Factor (tan δ) 損耗角正切	Measurement frequency 測試頻率: 120Hz, Temperature 溫度: 20°C <table border="1"> <thead> <tr> <th>Rated Voltage (V) 額定工作電壓</th> <th>160</th> <th>200</th> <th>250</th> <th>350</th> <th>400</th> <th>450</th> </tr> </thead> <tbody> <tr> <td>tan δ (max.) 最大損耗角正切</td> <td>0.15</td> <td>0.15</td> <td>0.15</td> <td>0.20</td> <td>0.20</td> <td>0.20</td> </tr> </tbody> </table>	Rated Voltage (V) 額定工作電壓	160	200	250	350	400	450	tan δ (max.) 最大損耗角正切	0.15	0.15	0.15	0.20	0.20	0.20
Rated Voltage (V) 額定工作電壓	160	200	250	350	400	450									
tan δ (max.) 最大損耗角正切	0.15	0.15	0.15	0.20	0.20	0.20									
Stability at Low Temperature 低溫特性	Measurement frequency 測試頻率: 120Hz <table border="1"> <thead> <tr> <th>Rated Voltage (V) 額定工作電壓</th> <th>160</th> <th>200</th> <th>250</th> <th>350</th> <th>400</th> <th>450</th> </tr> </thead> <tbody> <tr> <td>Impedance Ratio 阻抗比 Z(-25°C) / Z(20°C)</td> <td>3</td> <td>3</td> <td>3</td> <td>6</td> <td>6</td> <td>6</td> </tr> </tbody> </table>	Rated Voltage (V) 額定工作電壓	160	200	250	350	400	450	Impedance Ratio 阻抗比 Z(-25°C) / Z(20°C)	3	3	3	6	6	6
Rated Voltage (V) 額定工作電壓	160	200	250	350	400	450									
Impedance Ratio 阻抗比 Z(-25°C) / Z(20°C)	3	3	3	6	6	6									
Endurance 耐久性	After an application of DC bias voltage plus the rated ripple current for 5000 hours (3000 hours for Ø8, 2000 hours for Ø6.3) at 105°C the peak voltage shall not exceed the rated DC voltage, capacitors meet the characteristics listed below. 在 105°C 環境下，在不超過額定電壓的範圍內重疊規定的紋波電流，施加 5000 小時 (Ø8 為 3000 小時，Ø6.3 為 2000 小時) 電壓後，電容器的特性符合下表的規定。 <table border="1"> <tbody> <tr> <td>Capacitance Change 靜電容量變化率</td> <td>Within ±20% of initial measured value 初始值的±20%以內</td> </tr> <tr> <td>Dissipation Factor 損耗角正切</td> <td>≤200% of initial specified value 不大於規範值的 200%</td> </tr> <tr> <td>Leakage Current 漏電流</td> <td>≤initial specified value 不大於規範值</td> </tr> </tbody> </table>	Capacitance Change 靜電容量變化率	Within ±20% of initial measured value 初始值的±20%以內	Dissipation Factor 損耗角正切	≤200% of initial specified value 不大於規範值的 200%	Leakage Current 漏電流	≤initial specified value 不大於規範值								
Capacitance Change 靜電容量變化率	Within ±20% of initial measured value 初始值的±20%以內														
Dissipation Factor 損耗角正切	≤200% of initial specified value 不大於規範值的 200%														
Leakage Current 漏電流	≤initial specified value 不大於規範值														
Shelf Life 高溫貯存特性	After leaving capacitors under no load at 105°C for 1000 hours, they meet the specified value for load life characteristics listed above. 在 105°C 環境中無負荷放置 1000 小時後，電容器的特性符合高溫負荷特性中所列的規定值。														
Marking 標識	Printed with white colour on black sleeve (PVC) or printed with white colour on green sleeve (PET). 黑色膠管白字印刷 (PVC) 或綠色膠管白字印刷 (PET)。														

DRAWING & DIMENSIONS 外形圖及尺寸 (Unit: mm)

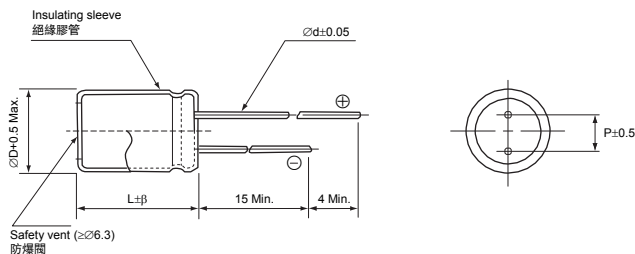

ØD	6.3	8 (L≤11.5)	8 (L≥16)	10	13	16
P	2.5	3.5		5.0		7.5
Ød	0.5		0.6		0.8	
β	1.5			2.0		

FREQUENCY COEFFICIENT OF ALLOWABLE RIPPLE CURRENT 紋波電流頻率補償系數

Frequency 頻率	120Hz	1KHz	10KHz	100KHz	
Coefficient 系數	1 ~ 4.7μF	0.20	0.40	0.80	1.00
	6.8 ~ 15μF	0.30	0.60	0.90	1.00
	22μF	0.40	0.70	0.90	1.00

The endurance of capacitors is reduced with internal heating produced by ripple current at the rate of halving the lifetime with every 5~10°C rise. When long life performance is required in actual use, the rms ripple current has to be reduced. 鋁電解電容器在疊加紋波電流後會引起發熱，溫度每上升 5~10°C 壽命會減半。若要保持長壽命性能，請在使用過程中適當降低紋波電流。

Note: All design and specifications are for reference only and is subject to change without prior notice. If any doubt about safety for your application, please contact us immediately for technical assistance before purchase.

注：以上所提供的設計及特性參數僅供參考，任何修改不作預先通知。如果在使用上有疑問，請在採購前與我們聯繫，以便提供技術上的協助。

CAT.2023/V2

TB Series

□ DIMENSIONS & MAXIMUM PERMISSIBLE RIPPLE CURRENT 規格尺寸及最大允許紋波電流

WV Parameter 參數 μF		160 (2C)		200 (2D)		250 (2E)	
		Case size ØD×L (mm) 尺寸	Ripple current (mA rms) 105°C, 100KHz 紋波電流	Case size ØD×L (mm) 尺寸	Ripple current (mA rms) 105°C, 100KHz 紋波電流	Case size ØD×L (mm) 尺寸	Ripple current (mA rms) 105°C, 100KHz 紋波電流
2.2	2R2	6.3 × 11.5	60	6.3 × 11.5	65	8 × 11.5	70
3.3	3R3	8 × 11.5	72	8 × 11.5	95	8 × 11.5	75
4.7	4R7	8 × 11.5	80	8 × 11.5	98	8 × 11.5	98
5.6	5R6	8 × 11.5	84	8 × 11.5	102	8 × 16	100
6.8	6R8	8 × 11.5	90	8 × 16 (10 × 12)	102 (108)	8 × 16	102
8.2	8R2	8 × 11.5	100	10 × 12	112	10 × 16	112
10	100	8 × 11.5	206	10 × 12	210	10 × 16	230
15	150	10 × 12	235	10 × 16	255	10 × 20	265
22	220	10 × 16	245	10 × 20	285	10 × 20 (13 × 21)	290 (300)
33	330	10 × 20	265	13 × 21	300	13 × 21	345
47	470	13 × 21	300	13 × 21	345	13 × 21 (13 × 25)	390 (410)
68	680	13 × 21	330	13 × 25	385	16 × 25	485
100	101	13 × 25	380	16 × 25	465	16 × 31	510

WV Parameter 參數 μF		350 (2V)		400 (2G)		450 (2W)	
		Case size ØD×L (mm) 尺寸	Ripple current (mA rms) 105°C, 100KHz 紋波電流	Case size ØD×L (mm) 尺寸	Ripple current (mA rms) 105°C, 100KHz 紋波電流	Case size ØD×L (mm) 尺寸	Ripple current (mA rms) 105°C, 100KHz 紋波電流
2.2	2R2	8 × 11.5	65	8 × 11.5	72	8 × 11.5	85
3.3	3R3	10 × 12	100	10 × 12	105	10 × 12	110
4.7	4R7	10 × 12	115	8 × 11.5 (10 × 12)	75 (120)	10 × 12	130
5.6	5R6	10 × 12	135	10 × 16	150	10 × 16	160
6.8	6R8	10 × 16	155	10 × 16	165	10 × 16	175
8.2	8R2	10 × 16	190	10 × 20	205	10 × 20	230
10	100	10 × 20	230	10 × 20	230	10 × 20	270
15	150	13 × 21	275	13 × 21	285	13 × 21	350
22	220	13 × 21	345	13 × 21 (13 × 25)	350 (390)	13 × 25	420
33	330	13 × 25	410	13 × 25 (16 × 20)	420 (480)	16 × 25	505
47	470	16 × 25	485	16 × 25	505	18 × 25	610
68	680	16 × 31	580	18 × 25	610	18 × 31	732
100	101	16 × 35	695	18 × 31 (18 × 35)	732 (845)	18 × 35 (18 × 40)	845 (875)

- Please refer to page 19 "Taping Specifications" & page 21 "Lead Forming & Cutting" about the taped or formed product spec. 編帶與引線成型標準請查閱第 19 頁“編帶標準”及第 21 頁“引線成型與剪腳”。
- Please refer to page 20 "Packaging Specifications" for the minimum package quantity. 最小包裝數量請查閱第 20 頁“包裝標準”。
- Please refer to page 16 for the Part Number System. 產品編碼規則請查閱第 16 頁。

Note: All design and specifications are for reference only and is subject to change without prior notice. If any doubt about safety for your application, please contact us immediately for technical assistance before purchase.

注：以上所提供的設計及特性參數僅供參考，任何修改不作預先通知。如果在使用上有疑問，請在採購前與我們聯繫，以便提供技術上的協助。

CAT.2023/V2

TX Series

HIGH RIPPLE CURRENT, LONG LIFE

高紋波電流，長壽命品

- High ripple current
高紋波電流特性
- Endurance 5000~10000 hours
耐久性 5000~10000 小時
- Suitable for electronic ballast, power supply and LED lighting
適用於電子鎮流器，電源和 LED 照明
- Comply with the RoHS & REACH
符合 RoHS 與 REACH

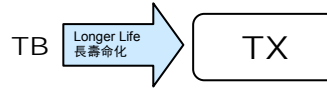
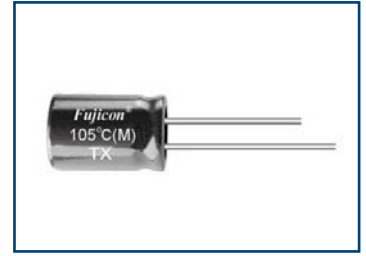

SPECIFICATIONS 特性表

Items 項目	Characteristics 主要特性															
Category Temperature Range 工作溫度範圍	-25 ~ +105°C															
Voltage Range 額定工作電壓範圍	160 ~ 450V															
Capacitance Range 靜電容量範圍	2.2 ~ 330μF															
Capacitance Tolerance 靜電容量允許偏差	±20% at 120Hz, 20°C															
Leakage Current 漏電流	Leakage current ≤0.03CV + 15μA (after 5 minutes application of rated voltage at 20°C) 漏電流 ≤0.03CV + 15μA (在 20°C 環境中施加額定工作電壓 5 分鐘後) C: Nominal capacitance (μF) 標稱靜電容量, V: Rated voltage (V) 額定電壓															
Dissipation Factor (tan δ) 損耗角正切	Measurement frequency 測試頻率: 120Hz, Temperature 溫度: 20°C <table border="1"> <thead> <tr> <th>Rated Voltage (V) 額定工作電壓</th> <th>160</th> <th>200</th> <th>250</th> <th>350</th> <th>400</th> <th>450</th> </tr> </thead> <tbody> <tr> <td>tan δ (max.) 最大損耗角正切</td> <td>0.15</td> <td>0.15</td> <td>0.15</td> <td>0.20</td> <td>0.20</td> <td>0.20</td> </tr> </tbody> </table>	Rated Voltage (V) 額定工作電壓	160	200	250	350	400	450	tan δ (max.) 最大損耗角正切	0.15	0.15	0.15	0.20	0.20	0.20	
Rated Voltage (V) 額定工作電壓	160	200	250	350	400	450										
tan δ (max.) 最大損耗角正切	0.15	0.15	0.15	0.20	0.20	0.20										
Stability at Low Temperature 低溫特性	Measurement frequency 測試頻率: 120Hz <table border="1"> <thead> <tr> <th>Rated Voltage (V) 額定工作電壓</th> <th>160</th> <th>200</th> <th>250</th> <th>350</th> <th>400</th> <th>450</th> </tr> </thead> <tbody> <tr> <td>Impedance Ratio 阻抗比</td> <td>Z(-25°C) / Z(20°C)</td> <td>3</td> <td>3</td> <td>3</td> <td>5</td> <td>5</td> <td>6</td> </tr> </tbody> </table>	Rated Voltage (V) 額定工作電壓	160	200	250	350	400	450	Impedance Ratio 阻抗比	Z(-25°C) / Z(20°C)	3	3	3	5	5	6
Rated Voltage (V) 額定工作電壓	160	200	250	350	400	450										
Impedance Ratio 阻抗比	Z(-25°C) / Z(20°C)	3	3	3	5	5	6									
Endurance 耐久性	The characteristics listed below shall be satisfied when the capacitors are restored to 20°C after subject to DC voltage with the rated ripple current is applied (the peak voltage shall not exceed the rated voltage) for the specified period of time at 105°C. 在 105°C 環境中的規定時間內施加額定紋波電流 (峰值電壓不得超過額定電壓) 後，電容器經直流電壓後恢復至 20°C 時，應符合下表參數要求。 <table border="1"> <thead> <tr> <th>Size (mm) 尺寸</th> <th>Life time (hours) 壽命 (小時)</th> </tr> </thead> <tbody> <tr> <td>∅D8</td> <td>5000</td> </tr> <tr> <td>∅D10</td> <td>8000</td> </tr> <tr> <td>∅D≥13</td> <td>10000</td> </tr> </tbody> </table> <table border="1"> <tbody> <tr> <td>Capacitance Change 靜電容量變化率</td> <td>Within ±20% of initial measured value 初始值的±20%以內</td> </tr> <tr> <td>Dissipation Factor 損耗角正切</td> <td>≤200% of initial specified value 不大於規範值的 200%</td> </tr> <tr> <td>Leakage Current 漏電流</td> <td>≤initial specified value 不大於規範值</td> </tr> </tbody> </table>	Size (mm) 尺寸	Life time (hours) 壽命 (小時)	∅D8	5000	∅D10	8000	∅D≥13	10000	Capacitance Change 靜電容量變化率	Within ±20% of initial measured value 初始值的±20%以內	Dissipation Factor 損耗角正切	≤200% of initial specified value 不大於規範值的 200%	Leakage Current 漏電流	≤initial specified value 不大於規範值	
Size (mm) 尺寸	Life time (hours) 壽命 (小時)															
∅D8	5000															
∅D10	8000															
∅D≥13	10000															
Capacitance Change 靜電容量變化率	Within ±20% of initial measured value 初始值的±20%以內															
Dissipation Factor 損耗角正切	≤200% of initial specified value 不大於規範值的 200%															
Leakage Current 漏電流	≤initial specified value 不大於規範值															
Shelf Life 高溫貯存特性	After leaving capacitors under no load at 105°C for 1000 hours, they meet the specified value for load life characteristics listed above. 在 105°C 環境中無負荷放置 1000 小時後，電容器的特性符合高溫負荷特性中所列的規定值。															
Marking 標識	Printed with white colour on black sleeve (PVC) or printed with white colour on green sleeve (PET). 黑色膠管白字印刷 (PVC) 或綠色膠管白字印刷 (PET)。															

DRAWING 外形圖 (Unit: mm)

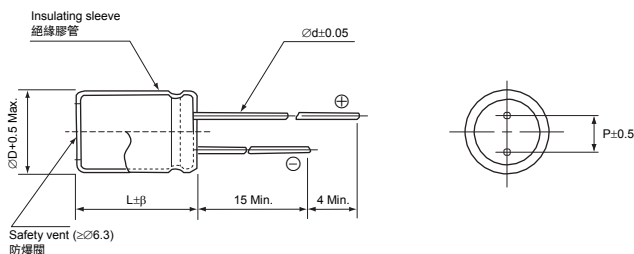

∅D	8 (L≤11.5)	8 (L≥16)	10	13	16	18
P	3.5		5.0		7.5	
∅d	0.5		0.6		0.8	
β	1.5			2.0		

FREQUENCY COEFFICIENT OF ALLOWABLE RIPPLE CURRENT 紋波電流頻率補償系數

Frequency 頻率	120Hz	1KHz	10KHz	100KHz
Coefficient 系數	0.85	0.90	1.00	1.10
	0.90	0.95	1.00	1.10

The endurance of capacitors is reduced with internal heating produced by ripple current at the rate of halving the lifetime with every 5~10°C rise. When long life performance is required in actual use, the rms ripple current has to be reduced. 鋁電解電容器在疊加紋波電流後會引起發熱，溫度每上升 5~10°C 壽命會減半。若要保持長壽命性能，請在使用過程中適當降低紋波電流。

Note: All design and specifications are for reference only and is subject to change without prior notice. If any doubt about safety for your application, please contact us immediately for technical assistance before purchase.
注：以上所提供的設計及特性參數僅供參考，任何修改不作預先通知。如果在使用上有疑問，請在採購前與我們聯繫，以便提供技術上的協助。

CAT.2023/V2

TX Series

DIMENSIONS & MAXIMUM PERMISSIBLE RIPPLE CURRENT 規格尺寸及最大允許紋波電流

WV		160 (2C)			200 (2D)		
Parameter 參數	Case size ØDxL (mm) 尺寸	Ripple current (mA rms) 紋波電流		Case size ØDxL (mm) 尺寸	Ripple current (mA rms) 紋波電流		
		105°C, 120Hz	105°C, 100KHz		105°C, 120Hz	105°C, 100KHz	
10	100	10 × 16	125	313	10 × 16	140	350
22	220	10 × 20	200	500	10 × 20	200	500
33	330	10 × 20	250	625	10 × 20	260	650
47	470	10 × 20	300	750	13 × 21	390	975
68	680	13 × 21	470	1175	13 × 21	470	1175
82	820	13 × 21	510	1275	16 × 20	550	1375
100	101	13 × 25 (16 × 20)	620 (630)	1395 (1418)	16 × 20	630	1418
150	151	16 × 25	770	1733	16 × 31	840	1890
220	221	16 × 31	1020	2295	18 × 31	1050	2363
330	331	18 × 35	1390	3128	18 × 40	1430	3218

WV		250 (2E)			350 (2V)		
Parameter 參數	Case size ØDxL (mm) 尺寸	Ripple current (mA rms) 紋波電流		Case size ØDxL (mm) 尺寸	Ripple current (mA rms) 紋波電流		
		105°C, 120Hz	105°C, 100KHz		105°C, 120Hz	105°C, 100KHz	
2.2	2R2	8 × 11.5	75	130	8 × 11.5	80	165
3.3	3R3	8 × 11.5	80	145	10 × 12	90	185
4.7	4R7	8 × 11.5	96	180	10 × 12	100	210
6.8	6R8	8 × 16 (10 × 12)	105 (120)	235 (250)	10 × 16	125	275
10	100	10 × 20	140	350	10 × 20	140	650
22	220	10 × 20	200	500	16 × 20	360	900
47	470	13 × 21	390	975	16 × 20	430	1075
68	680	16 × 20	520	1300	16 × 31 (18 × 25)	560 (550)	1400 (1375)
82	820	16 × 25	550	1375	18 × 31	610	1525
100	101	16 × 25 (16 × 31)	620 (680)	1450 (1530)	18 × 31	700	1575
150	151	18 × 31	860	1935	18 × 40	960	2160
220	221	18 × 40	1130	2543			

WV		400 (2G)			450 (2W)		
Parameter 參數	Case size ØDxL (mm) 尺寸	Ripple current (mA rms) 紋波電流		Case size ØDxL (mm) 尺寸	Ripple current (mA rms) 紋波電流		
		105°C, 120Hz	105°C, 100KHz		105°C, 120Hz	105°C, 100KHz	
2.2	2R2	8 × 11.5 (10 × 12)	80 85	165 175			
3.3	3R3	10 × 12	90	185	10 × 12	60	165
4.7	4R7	10 × 12	100	210	10 × 16	70	185
5.6	5R6	10 × 12	105	200			
6.8	6R8	10 × 12 (10 × 16)	111 (125)	230 (275)	10 × 20	110	275
10	100	10 × 16 (10 × 20)	120 (140)	320 (350)	13 × 21	180	450
22	220	13 × 21	260	650	16 × 20	290	725
33	330	16 × 20	360	900	16 × 25	390	975
47	470	16 × 25 (18 × 20)	470 (450)	1175 (1125)	18 × 25	480	1200
68	680	18 × 25	585	1463	18 × 31	630	1575
82	820	18 × 31	610	1525	18 × 35	715	1788
100	101	18 × 35	765	1721	18 × 40	800	1800

- Please refer to page 19 "Taping Specifications" & page 21 "Lead Forming & Cutting" about the taped or formed product spec. 編帶與引線成型標準請查閱第 19 頁 "編帶標準" 及第 21 頁 "引線成型與剪腳"。
- Please refer to page 20 "Packaging Specifications" for the minimum package quantity. 最小包裝數量請查閱第 20 頁 "包裝標準"。
- Please refer to page 16 for the Part Number System. 產品編碼規則請查閱第 16 頁。

Note: All design and specifications are for reference only and is subject to change without prior notice. If any doubt about safety for your application, please contact us immediately for technical assistance before purchase.

注：以上所提供的設計及特性參數僅供參考，任何修改不作預先通知。如果在使用上有疑問，請在採購前與我們聯繫，以便提供技術上的協助。

CAT.2023/V2

PL Series

HIGH RIPPLE CURRENT, HIGH RELIABILITY

高紋波電流，高可靠品

- High ripple current
高紋波電流特性
- Endurance 5000 hours
耐久性 5000 小時
- Suitable for SMPS and adaptor
適用於開關式電源及變壓器
- Comply with the RoHS & REACH
符合 RoHS 與 REACH

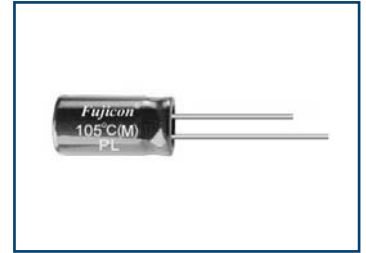

SPECIFICATIONS 特性表

Items 項目	Characteristics 主要特性		
Category Temperature Range 工作溫度範圍	-40 ~ +105°C		-25 ~ +105°C
Voltage Range 額定工作電壓範圍	400V		450V
Capacitance Range 靜電容量範圍	33 ~ 150µF		33 ~ 150µF
Capacitance Tolerance 靜電容量允許偏差	±20% at 120Hz, 20°C		
Leakage Current 漏電流	Leakage current ≤0.02CV + 15µA (after 5 minutes application of rated voltage at 20°C) 漏電流 ≤0.02CV + 15µA (在 20°C 環境中施加額定工作電壓 5 分鐘後) C: Nominal capacitance (µF) 標稱靜電容量, V: Rated voltage (V) 額定電壓		
Dissipation Factor (tan δ) 損耗角正切	Measurement frequency 測試頻率: 120Hz, Temperature 溫度: 20°C		
	Rated Voltage (V) 額定工作電壓	400	450
	tan δ (max.) 最大損耗角正切	0.24	0.24
Stability at Low Temperature 低溫特性	Measurement frequency 測試頻率: 120Hz		
	Rated Voltage (V) 額定工作電壓	400	450
	Impedance Ratio 阻抗比	Z(-25°C) / Z(20°C) Z(-40°C) / Z(20°C)	6 6
Endurance 耐久性	After applying rated voltage and rated ripple current for 5000 hours at 105°C, the capacitors shall meet the characteristics listed below. 在 105°C 環境中施加額定工作電壓及額定紋波電流 5000 小時後，電容器的特性符合下表的要求。		
	Capacitance Change 靜電容量變化率	Within ±20% of initial measured value 初始值的±20%以內	
	Dissipation Factor 損耗角正切	≤200% of initial specified value 不大於規範值的 200%	
	Leakage Current 漏電流	≤initial specified value 不大於規範值	
Shelf Life 高溫貯存特性	After leaving capacitors under no load at 105°C for 1000 hours, they meet the specified value for load life characteristics listed above. 在 105°C 環境中無負荷放置 1000 小時後，電容器的特性符合高溫負荷特性中所列的規定值。		
Marking 標識	Printed with white colour on black sleeve (PVC) or printed with white colour on green sleeve (PET). 黑色膠管白字印刷 (PVC) 或綠色膠管白字印刷 (PET)。		

DRAWING & DIMENSIONS 外形圖及尺寸 (Unit: mm)

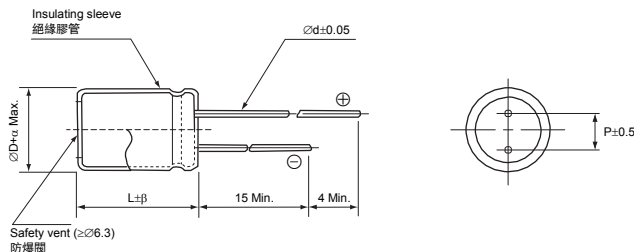

ØD	10	13	16	18
P	5.0		7.5	
Ød	0.6		0.8	
β	2.5			

FREQUENCY COEFFICIENT OF ALLOWABLE RIPPLE CURRENT 紋波電流頻率補償系數

Frequency 頻率	60Hz	120Hz	1KHz	10KHz~
Coefficient 系數	400 ~ 450VV			
	0.80	1.00	1.40	1.50

The endurance of capacitors is reduced with internal heating produced by ripple current at the rate of halving the lifetime with every 5~10°C rise. When long life performance is required in actual use, the rms ripple current has to be reduced. 鋁電解電容器在疊加紋波電流後會引起發熱，溫度每上升 5~10°C 壽命會減半。若要保持長壽命性能，請在使用過程中適當降低紋波電流。

Note: All design and specifications are for reference only and is subject to change without prior notice. If any doubt about safety for your application, please contact us immediately for technical assistance before purchase.
注：以上所提供的設計及特性參數僅供參考，任何修改不作預先通知。如果在使用上有疑問，請在採購前與我們聯繫，以便提供技術上的協助。

CAT.2023/V2

PL Series

□ DIMENSIONS & MAXIMUM PERMISSIBLE RIPPLE CURRENT 規格尺寸及最大允許紋波電流

Parameter 參數 μF		400 (2G)			450 (2W)		
		Case size ØD×L (mm) 尺寸	Ripple current (mA rms) 紋波電流		Case size ØD×L (mm) 尺寸	Ripple current (mA rms) 紋波電流	
			105°C, 120Hz	105°C, 100KHz		105°C, 120Hz	105°C, 100KHz
33	330	10 × 35	320	480	10 × 40 (13 × 30)	350 (350)	525 (525)
39	390	10 × 40 (13 × 30)	380 (380)	570 (570)	10 × 45 (13 × 35) (16 × 25)	390 (400) (370)	585 (600) (555)
47	470	10 × 45 (16 × 25)	425 (400)	638 (600)	10 × 50 (13 × 40) (16 × 31)	445 (425) (455)	668 (683) (683)
56	560	10 × 50 (13 × 35)	490 (475)	735 (713)	13 × 45 (16 × 35)	500 (550)	750 (750)
68	680	13 × 40 (16 × 31)	550 (530)	825 (795)	16 × 40 (18 × 31)	590 (550)	885 (825)
82	820	13 × 45 (16 × 35)	615 (605)	923 (908)	13 × 50 (16 × 45) (18 × 35)	625 (675) (645)	938 (1013) (968)
100	101	13 × 50 (16 × 40) (18 × 31)	690 (740) (625)	1035 (1110) (938)	16 × 50 (18 × 40)	785 (740)	1178 (1110)
120	121	16 × 45 (18 × 35)	795 (730)	1193 (1095)	18 × 45	825	1238
150	151	18 × 45	910	1365	18 × 50	950	1425

- Please refer to page 19 "Taping Specifications" & page 21 "Lead Forming & Cutting" about the taped or formed product spec. 編帶與引線成型標準請查閱第19頁“編帶標準”及第21頁“引線成型與剪腳”。
- Please refer to page 20 "Packaging Specifications" for the minimum package quantity. 最小包裝數量請查閱第20頁“包裝標準”。
- Please refer to page 16 for the Part Number System. 產品編碼規則請查閱第16頁。

Note: All design and specifications are for reference only and is subject to change without prior notice. If any doubt about safety for your application, please contact us immediately for technical assistance before purchase.

注：以上所提供的設計及特性參數僅供參考，任何修改不作預先通知。如果在使用上有疑問，請在採購前與我們聯繫，以便提供技術上的協助。

CAT.2023/V2

Aluminum Electrolytic Capacitors (Snap-in Terminal Type)
鋁電解電容器 (導箔式)



Note: All design and specifications are for reference only and is subject to change without prior notice. If any doubt about safety for your application, please contact us immediately for technical assistance before purchase.

注：以上所提供的設計及特性參數僅供參考，任何修改不作預先通知。如果在使用上有疑問，請在採購前與我們聯繫，以便提供技術上的協助。

CAT.2023/V2

SM Series

SNAP-IN TERMINAL TYPE, STANDARD

導箔型，標準品

- Standard snap-in terminal series
導箔型標準品系列
- Voltage range of 6.3~450V
額定工作電壓範圍 6.3~450V
- Comply with the RoHS & REACH
符合 RoHS 與 REACH

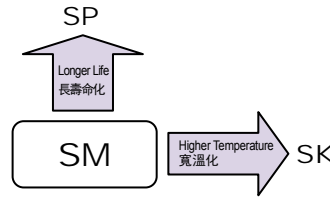

□ SPECIFICATIONS 特性表

Items 項目	Characteristics 主要特性	
Category Temperature Range 工作溫度範圍	-40 ~ +85°C	-25 ~ +85°C
Voltage Range 額定工作電壓範圍	6.3 ~ 350V	400 ~ 450V
Capacitance Range 靜電容量範圍	82 ~ 10000µF	68 ~ 560µF
Capacitance Tolerance 靜電容量允許偏差	±20% at 120Hz, 20°C	
Leakage Current 漏電流	$I \leq 3\sqrt{CV}$ (after 5 minutes application of rated voltage at 20°C) (在 20°C 環境中施加額定工作電壓 5 分鐘後) I: Leakage current (µA) 漏電流, C: Nominal capacitance (µF) 標稱靜電容量, V: Rated voltage (V) 額定電壓	
Dissipation Factor (tan δ) 損耗角正切	When nominal capacitance is over 1000µF, tan δ shall be added 0.01 to the listed value with increase of every 1000µF. 當標稱靜電容量大於 1000µF, 其標稱靜電容量每增加 1000µF, 損耗角正切增加 0.01. Measurement frequency 測試頻率: 120Hz, Temperature 溫度: 20°C	
Stability at Low Temperature 低溫特性	Measurement frequency 測試頻率: 120Hz	
	Rated Voltage (V) 額定工作電壓	6.3, 10, 16, 25, 35, 50, 63, 80, 100, 160~400, 450
Endurance 耐久性	After 2000 hours application of the rated voltage at 85°C, they meet the characteristics listed below. 在 85°C 環境中施加額定工作電壓 2000 小時後, 電容器的特性符合下表的要求。	
	Capacitance Change 靜電容量變化率	Within ±20% of initial value 初始值的±20%以內
Shelf Life 高溫貯存特性	After leaving capacitors under no load at 85°C for 1000 hours, they meet the specified listed below. 在 85°C 環境中無負荷放置 1000 小時後, 電容器的特性符合下表的要求。	
	Capacitance Change 靜電容量變化率	Within ±20% of initial value 初始值的±20%以內
Marking 標識	Printed with white colour on black sleeve (PVC) or printed with white colour on green sleeve (PET). 黑色膠管白字印刷 (PVC) 或綠色膠管白字印刷 (PET)。	

□ DRAWING & DIMENSIONS 外形圖及尺寸 (Unit: mm)

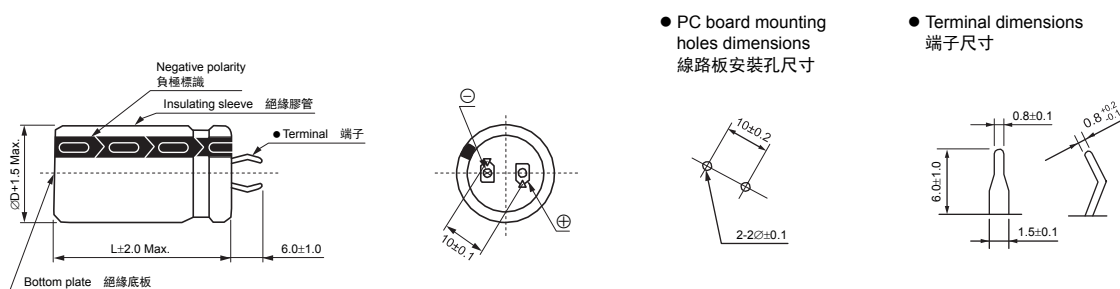

□ FREQUENCY COEFFICIENT OF ALLOWABLE RIPPLE CURRENT 紋波電流頻率補償系數

Frequency 頻率	50Hz	120Hz	300Hz	1KHz	10KHz~
Coefficient 系數					
~ 100µF	0.88	1.0	1.06	1.15	1.20
160 ~ 250µF	0.85	1.0	1.20	1.25	1.45
315µF ~	0.88	1.0	1.15	1.20	1.40

The endurance of capacitors is reduced with internal heating produced by ripple current at the rate of halving the lifetime with every 5~10°C rise. When long life performance is required in actual use, the rms ripple current has to be reduced. 鋁電解電容器在疊加紋波電流後會引起發熱, 溫度每上升 5~10°C 壽命會減半。若要保持長壽命性能, 請在使用過程中適當降低紋波電流。

Note: All design and specifications are for reference only and is subject to change without prior notice. If any doubt about safety for your application, please contact us immediately for technical assistance before purchase.
注: 以上所提供的設計及特性參數僅供參考, 任何修改不作預先通知。如果在使用上有疑問, 請在採購前與我們聯繫, 以便提供技術上的協助。

CAT.2023/V2

SM Series

□ DIMENSIONS & MAXIMUM PERMISSIBLE RIPPLE CURRENT 規格尺寸及最大允許紋波電流

WV μF / ∅D		6.3 (0J)				10 (1A)				16 (1C)				
		22	25	30	35	22	25	30	35	22	25	30	35	
10000	103									22 x 25 3.32				
12000	123					22 x 25 3.31				22 x 30 3.56	25 x 25 3.89			
15000	153	22 x 25 3.39				22 x 30 3.82	25 x 25 3.39			22 x 35 4.29	25 x 30 4.45	30 x 25 4.56		
18000	183	22 x 30 3.85	25 x 25 3.96			22 x 35 4.28	25 x 25 4.17			22 x 40 4.77	25 x 35 4.96	30 x 30 5.10		
22000	223	22 x 35 4.34	25 x 25 4.22			22 x 40 4.79	25 x 30 4.71	30 x 25 4.83		22 x 50 5.51	25 x 40 5.51	30 x 30 5.39		
27000	273	22 x 40 4.85	25 x 30 4.77	30 x 25 4.89		22 x 45 5.30	25 x 35 5.26	30 x 30 5.41			25 x 45 6.06	30 x 35 5.98	35 x 25 5.80	
33000	333	22 x 50 5.83	25 x 35 5.32	30 x 30 5.47		22 x 50 5.82	25 x 40 5.81	30 x 30 5.69	35 x 25 5.81			30 x 40 6.56	35 x 30 6.41	
39000	393		25 x 40 5.82	30 x 30 5.70	35 x 25 5.82		25 x 45 6.31	30 x 35 6.22	35 x 30 6.8			30 x 45 7.08	35 x 35 6.96	
47000	473		25 x 45 6.35	30 x 35 6.26	35 x 30 6.41		25 x 50 6.83	30 x 40 6.78	35 x 30 6.62			30 x 50 7.62	35 x 40 7.54	
56000	563		25 x 50 6.85	30 x 40 6.80	35 x 30 6.64			30 x 45 7.31	35 x 35 7.18				35 x 45 8.08	
68000	683			30 x 45 7.35	35 x 35 7.23				35 x 40 7.76				35 x 50 8.63	
100000	104				35 x 45 8.34	→ Case size 尺寸								
						→ Ripple current 紋波電流								

WV μF / ∅D		25 (1E)				35 (1V)				50 (1H)			
		22	25	30	35	22	25	30	35	22	25	30	35
3300	332									22 x 30 2.97	25 x 25 3.06		
4700	472					22 x 30 3.06	25 x 25 2.98			22 x 40 3.83	25 x 35 3.98	30 x 25 3.86	35 x 25 4.19
5600	562	22 x 25 2.65				22 x 35 3.28	25 x 30 3.39			22 x 45 4.26	25 x 40 4.44	30 x 30 4.35	35 x 25 4.44
6800	682	22 x 30 3.06	25 x 25 3.15			22 x 40 3.73	25 x 30 3.67	30 x 25 3.76		22 x 50 4.77	25 x 40 4.76	30 x 35 4.92	35 x 30 5.04
8200	822	22 x 35 3.45	25 x 30 3.57			22 x 45 4.13	25 x 35 4.10	30 x 30 4.22			25 x 50 5.43	30 x 40 5.38	35 x 30 5.26
10000	103	22 x 40 3.95	25 x 30 3.89	30 x 25 3.99		22 x 50 4.68	35 x 40 4.68	30 x 30 4.58				30 x 45 6.07	35 x 35 5.97
12000	123	22 x 45 4.41	25 x 35 4.37	30 x 30 4.50			25 x 45 5.18	30 x 35 5.11	35 x 30 5.24			30 x 50 6.62	35 x 40 6.55
15000	153	22 x 50 4.94	25 x 40 4.94	30 x 35 5.10				30 x 40 5.72	35 x 35 5.88				35 x 45 7.20
18000	183		25 x 45 5.45	30 x 35 5.38	35 x 30 5.51			30 x 45 6.28	35 x 40 6.46				35 x 50 7.74
22000	223			30 x 45 6.22	35 x 35 6.12				35 x 45 7.07				35 x 55 8.28
27000	273			30 x 50 6.82	35 x 40 6.74	→ Case size 尺寸							
33000	333				35 x 45 7.35	→ Ripple current 紋波電流							

WV μF / ∅D		63 (1J)				80 (1K)				100 (2A)			
		22	25	30	35	22	25	30	35	22	25	30	35
1200	122					22 x 25 2.24				22 x 30 2.39	25 x 25 2.46		
1500	152					22 x 30 2.67				22 x 35 2.83	25 x 30 2.93	30 x 25 3.00	
1800	182	22 x 25 2.20				22 x 30 2.92	25 x 25 3.01			22 x 40 3.26	25 x 35 3.39	30 x 30 3.49	
2200	222	22 x 30 2.50	25 x 25 2.58			22 x 35 3.25	25 x 30 3.36	30 x 25 3.45		22 x 45 3.58	25 x 40 3.74	30 x 30 3.66	
2700	272	22 x 35 2.94	25 x 30 3.04			22 x 40 3.79	25 x 35 3.94	30 x 30 4.05			25 x 45 4.33	30 x 35 4.27	35 x 30 4.37
3300	332	22 x 35 3.14	25 x 30 3.26	30 x 25 3.34		22 x 45 4.18	25 x 40 4.36	30 x 30 4.27			25 x 50 4.76	30 x 40 4.72	35 x 35 4.85
3900	392	22 x 40 3.60	25 x 35 3.74	30 x 30 3.85		22 x 50 4.75	25 x 45 4.96	30 x 35 4.89				30 x 45 5.36	35 x 35 5.27
4700	472	22 x 50 4.19	25 x 40 4.19	30 x 35 4.10	35 x 30 4.19		25 x 50 5.44	30 x 40 5.39	35 x 30 5.27			30 x 50 5.86	35 x 40 5.80
5600	562		25 x 45 4.65	30 x 35 4.58	35 x 30 4.70			30 x 45 5.91	35 x 35 5.81				35 x 45 6.34
6800	682		25 x 50 5.20	30 x 40 5.16	35 x 30 5.04				35 x 40 5.46				35 x 45 6.52
8200	822			30 x 45 5.62	35 x 35 5.53			35 x 45 6.91	→ Case size 尺寸				
10000	103			30 x 50 6.32	35 x 40 6.25			35 x 60 8.24	→ Ripple current 紋波電流				
12000	123				35 x 45 6.83								

•Case size ∅D×L(mm), ripple current (A rms) at 85°C, 120Hz •尺寸∅D×L(mm), 紋波電流(A rms)於 85°C, 120Hz

Note: All design and specifications are for reference only and is subject to change without prior notice. If any doubt about safety for your application, please contact us immediately for technical assistance before purchase.

注：以上所提供的設計及特性參數僅供參考，任何修改不作預先通知。如果在使用上有疑問，請在採購前與我們聯繫，以便提供技術上的協助。

CAT.2023/V2

SM Series

□ DIMENSIONS & MAXIMUM PERMISSIBLE RIPPLE CURRENT 規格尺寸及最大允許紋波電流

WV		160 (2C)				200 (2D)				250 (2E)			
μF	∅D	22	25	30	35	22	25	30	35	22	25	30	35
150	151									22 x 25 0.90	25 x 20 0.92		
180	181					22 x 20 0.91				22 x 25 0.90	25 x 20 1.01		
220	221	22 x 20 1.01				22 x 25 1.09	25 x 20 1.11			22 x 25 1.09	25 x 25 1.19	30 x 20 1.22	
270	271	22 x 25 1.20	25 x 20 1.32			22 x 25 1.20	25 x 25 1.32	30 x 20 1.35		22 x 30 1.28	25 x 25 1.32	30 x 20 1.35	
330	331	22 x 25 1.33	25 x 20 1.36			22 x 30 1.42	25 x 25 1.46	30 x 20 1.49		22 x 35 1.50	25 x 30 1.56	30 x 25 1.60	35 x 20 1.62
390	391	22 x 25 1.45	25 x 25 1.59	30 x 20 1.62		22 x 30 1.54	25 x 25 1.59	30 x 25 1.74	35 x 20 1.77	22 x 40 1.72	25 x 30 1.69	30 x 25 1.73	35 x 20 1.77
470	471	22 x 30 1.69	25 x 25 1.75	30 x 20 1.78		22 x 35 1.79	25 x 30 1.86	30 x 25 1.90	35 x 20 1.94	22 x 45 1.98	25 x 35 1.96	30 x 30 2.02	35 x 25 2.06
560	561	22 x 35 1.96	25 x 30 2.03	30 x 25 2.08	35 x 20 2.12	22 x 40 2.06	25 x 35 2.14	30 x 25 2.08	35 x 25 2.25	22 x 50 2.26	25 x 40 2.25	30 x 30 2.20	35 x 25 2.25
680	681	22 x 40 2.27	25 x 30 2.23	30 x 25 2.29	35 x 20 2.33	22 x 45 2.38	25 x 40 2.48	30 x 30 2.43	35 x 25 2.48		25 x 45 2.60	30 x 35 2.56	35 x 30 2.62
820	821	22 x 45 2.61	25 x 35 2.59	30 x 30 2.67	35 x 25 2.73	22 x 50 2.73	25 x 45 2.85	30 x 35 2.81	35 x 30 2.88			30 x 40 2.95	35 x 35 3.03
1000	102	22 x 50 3.01	25 x 40 3.01	30 x 30 2.95	35 x 25 3.01	22 x 50 2.82	25 x 45 2.85	30 x 40 3.26	35 x 30 3.18			30 x 45 3.40	35 x 40 3.50
1200	122		25 x 45 3.23	30 x 35 3.37	35 x 30 3.26			30 x 45 3.49	35 x 35 3.43				35 x 45 3.74
1500	152			30 x 40 3.73	35 x 35 3.83			30 x 50 4.06	35 x 40 4.01				35 x 50 4.35
1800	182				35 x 40 4.39				35 x 45 4.58	→ Case size 尺寸			
										→ Ripple current 紋波電流			

WV		315 (2F)				350 (2V)				400 (2G)			
μF	∅D	22	25	30	35	22	25	30	35	22	25	30	35
68	680									22 x 20 0.56			
82	820					22 x 20 0.62				22 x 25 0.66	25 x 20 0.68		
100	101	22 x 20 0.68				22 x 25 0.73	25 x 20 0.75			22 x 30 0.78	25 x 25 0.81	30 x 20 0.82	
120	121	22 x 25 0.80	25 x 20 0.82			22 x 30 0.86	25 x 25 0.88	30 x 20 0.90		22 x 30 0.86	25 x 25 0.88	30 x 20 0.90	
150	151	22 x 30 0.96	25 x 25 0.99	30 x 20 1.01		22 x 35 1.01	25 x 30 1.05	30 x 20 1.01		22 x 35 1.01	25 x 30 1.05	30 x 25 1.08	35 x 20 1.09
180	181	22 x 35 1.11	25 x 30 1.15	30 x 25 1.18	35 x 20 1.20	22 x 40 1.17	25 x 35 1.21	30 x 25 1.18	35 x 20 1.20	22 x 40 1.17	25 x 35 1.21	30 x 25 1.18	35 x 25 1.28
220	221	22 x 40 1.29	25 x 30 1.27	30 x 25 1.30	35 x 20 1.33	22 x 45 1.35	25 x 35 1.34	30 x 30 1.38	35 x 25 1.41	22 x 45 1.35	25 x 40 1.41	30 x 30 1.38	35 x 25 1.41
270	271	22 x 45 1.50	25 x 35 1.49	30 x 30 1.53	35 x 25 1.56		25 x 45 1.64	30 x 35 1.61	35 x 25 1.65		25 x 45 1.64	30 x 35 1.61	35 x 30 1.65
330	331	22 x 50 1.73	25 x 40 1.73	30 x 35 1.78	35 x 30 1.83		25 x 50 1.89	30 x 40 1.87	35 x 30 1.83		25 x 50 1.89	30 x 40 1.87	35 x 30 1.83
390	391		25 x 45 1.97	30 x 35 1.94	35 x 30 1.99			30 x 45 2.12	35 x 35 2.09			30 x 45 2.12	35 x 35 2.09
470	471			30 x 40 2.23	35 x 35 2.29			30 x 50 2.43	35 x 40 2.40			30 x 50 2.43	35 x 40 2.40
560	561				35 x 40 2.62				35 x 45 2.73				35 x 45 2.73
680	681				35 x 45 3.01				35 x 50 3.13	→ Case size 尺寸			35 x 50 2.98
820	821				35 x 50 3.44					→ Ripple current 紋波電流			

WV		450 (2W)			
μF	∅D	22	25	30	35
56	560	22 x 20 0.51			
68	680	22 x 25 0.60	25 x 20 0.62		
82	820	22 x 30 0.71	25 x 25 0.73	30 x 20 0.74	
100	101	22 x 35 0.83	25 x 30 0.86	30 x 25 0.88	35 x 20 0.89
120	121	22 x 40 0.95	25 x 35 0.99	30 x 25 0.96	35 x 20 0.98
150	151	22 x 50 1.17	25 x 40 1.17	30 x 30 1.14	35 x 25 1.17
180	181		25 x 45 1.34	30 x 35 1.32	35 x 25 1.28
220	221		25 x 50 1.54	30 x 40 1.53	35 x 30 1.49
270	270			30 x 45 1.77	35 x 35 1.74
330	331			30 x 50 2.03	35 x 40 2.01
390	391				35 x 45 2.28
470	471				35 x 45 2.52

→ Case size ∅D×L(mm)
→ Ripple current (A rms) at 85°C, 120Hz

→ 尺寸∅D×L(mm)
→ 紋波電流(A rms)於 85°C, 120Hz

- Please refer to page 20 "Packaging Specifications" for the minimum package quantity. 最小包裝數量請查閱第 20 頁“包裝標準”。
- Please refer to page 16 for the Part Number System. 產品編碼規則請查閱第 16 頁。

Note: All design and specifications are for reference only and is subject to change without prior notice. If any doubt about safety for your application, please contact us immediately for technical assistance before purchase.

注：以上所提供的設計及特性參數僅供參考，任何修改不作預先通知。如果在使用上有疑問，請在採購前與我們聯繫，以便提供技術上的協助。

CAT.2023/V2

SK Series

SNAP-IN TERMINAL TYPE, WIDE TEMPERATURE RANGE

導箔型，寬溫品

- Wide temperature range of -40(-25)~+105°C
適用於 -40(-25)~+105°C 的寬溫溫度範圍
- Standard snap-in terminal series
導箔型標準品系列
- Comply with the RoHS & REACH
符合 RoHS 與 REACH

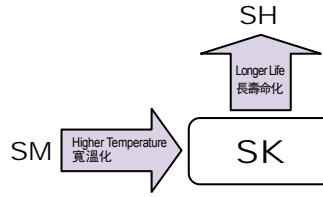

□ SPECIFICATIONS 特性表

Items 項目	Characteristics 主要特性	
Category Temperature Range 工作溫度範圍	-40 ~ +105°C	-25 ~ +105°C
Voltage Range 額定工作電壓範圍	6.3 ~ 350V	400 ~ 450V
Capacitance Range 靜電容量範圍	68 ~ 68000µF	56 ~ 470µF
Capacitance Tolerance 靜電容量允許偏差	±20% at 120Hz, 20°C	
Leakage Current 漏電流	$I \leq 3\sqrt{CV}$ (after 5 minutes application of rated voltage at 20°C) (在 20°C 環境中施加額定工作電壓 5 分鐘後) I: Leakage current (µA) 漏電流, C: Nominal capacitance (µF) 標稱靜電容量, V: Rated voltage (V) 額定電壓	
Dissipation Factor (tan δ) 損耗角正切	When nominal capacitance is over 1000µF, tan δ shall be added 0.01 to the listed value with increase of every 1000µF. 當標稱靜電容量大於 1000µF, 其標稱靜電容量每增加 1000µF, 損耗角正切增加 0.01. Measurement frequency 測試頻率: 120Hz, Temperature 溫度: 20°C	
Stability at Low Temperature 低溫特性	Rated Voltage (V) 額定工作電壓	10 16 25, 35 50, 63 80, 100 160~400 450
	tan δ (max.) 最大損耗角正切	0.50 0.40 0.35 0.25 0.20 0.15 0.20
Endurance 耐久性	Capacitance Change 靜電容量變化率	Within ±20% of initial value 初始值的±20%以內
	Dissipation Factor 損耗角正切	Less than 200% of specified value 不大於規範值的 200%
Shelf Life 高溫貯存特性	Capacitance Change 靜電容量變化率	Within ±20% of initial value 初始值的±20%以內
	Dissipation Factor 損耗角正切	Less than 200% of specified value 不大於規範值的 200%
Marking 標識	Printed with white colour on black sleeve (PVC) or printed with white colour on green sleeve (PET). 黑色膠管白字印刷 (PVC) 或綠色膠管白字印刷 (PET).	

□ DRAWING & DIMENSIONS 外形圖及尺寸 (Unit: mm)

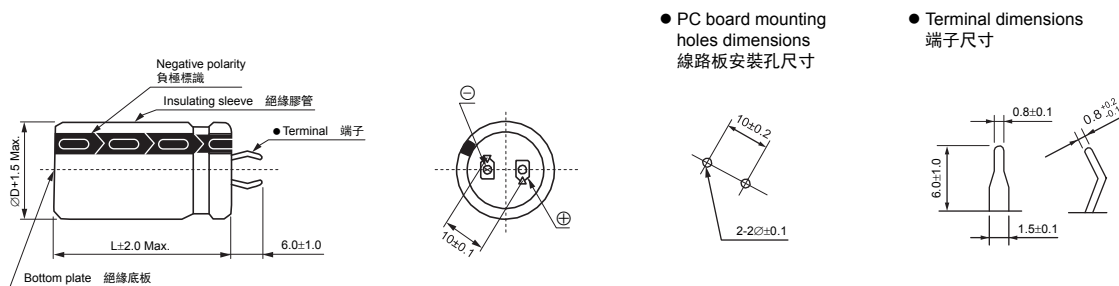

□ FREQUENCY COEFFICIENT OF ALLOWABLE RIPPLE CURRENT 紋波電流頻率補償系數

Frequency 頻率	50Hz	120Hz	300Hz	1KHz	10KHz~
Coefficient 系數					
~ 100µF	0.88	1.0	1.06	1.15	1.20
160 ~ 250µF	0.85	1.0	1.20	1.25	1.45
315µF ~	0.88	1.0	1.15	1.20	1.40

The endurance of capacitors is reduced with internal heating produced by ripple current at the rate of halving the lifetime with every 5~10°C rise. When long life performance is required in actual use, the rms ripple current has to be reduced. 鋁電解電容器在疊加紋波電流後會引起發熱，溫度每上升 5~10°C 壽命會減半。若要保持長壽命性能，請在使用過程中適當降低紋波電流。

Note: All design and specifications are for reference only and is subject to change without prior notice. If any doubt about safety for your application, please contact us immediately for technical assistance before purchase.
注：以上所提供的設計及特性參數僅供參考，任何修改不作預先通知。如果在使用上有疑問，請在採購前與我們聯繫，以便提供技術上的協助。

CAT.2023/V2

SK Series

□ DIMENSIONS & MAXIMUM PERMISSIBLE RIPPLE CURRENT 規格尺寸及最大允許紋波電流

WV μF / ∅D		6.3 (0J)				10 (1A)				16 (1C)			
		22	25	30	35	22	25	30	35	22	25	30	35
8200	822									22 x 25 2.14			
10000	103					22 x 25 2.17				22 x 30 2.48	25 x 25 2.56		
12000	123	22 x 25 2.19				22 x 30 2.48				22 x 35 2.80	25 x 30 2.90	30 x 25 2.97	
15000	153	22 x 30 2.53				22 x 35 2.83	25 x 25 2.75			22 x 40 3.17	25 x 35 3.29	30 x 30 3.38	
18000	183	22 x 35 2.85	25 x 25 2.77			22 x 35 3.00	25 x 30 3.11			22 x 45 3.50	25 x 40 3.65	30 x 30 3.57	
22000	223	22 x 35 3.04	25 x 30 3.15			22 x 40 3.35	25 x 35 3.48	30 x 25 3.38			25 x 45 4.03	30 x 35 3.98	
27000	273	22 x 40 3.40	25 x 35 3.53	30 x 25 3.42		22 x 50 3.88	25 x 40 3.87	30 x 30 3.79			25 x 50 4.42	30 x 40 4.39	35 x 30 4.29
33000	333	22 x 50 3.92	25 x 40 3.91	30 x 30 3.83			25 x 45 4.26	30 x 35 4.20				30 x 45 4.79	35 x 35 4.71
39000	393		25 x 45 4.26	30 x 35 4.20			25 x 50 4.60	30 x 40 4.57				30 x 50 5.16	35 x 40 5.10
47000	473		25 x 50 4.63	30 x 40 4.60	35 x 30 4.50			30 x 45 4.95	35 x 30 4.46				35 x 45 5.50
56000	563			30 x 50 5.17	35 x 40 5.12			30 x 45 4.95	35 x 35 4.87				
68000	683				35 x 45 5.52				35 x 45 5.49				

→ Case size 尺寸
→ Ripple current 紋波電流

WV μF / ∅D		25 (1E)				35 (1V)				50 (1H)			
		22	25	30	35	22	25	30	35	22	25	30	35
2700	272									22 x 30 1.94			
3300	332					22 x 25 1.62				22 x 35 2.20			
3900	392					22 x 30 1.88				22 x 40 2.52	25 x 35 2.62	30 x 25 2.54	
4700	472	22 x 25 1.73				22 x 35 2.14	25 x 25 2.09			22 x 45 2.81	25 x 40 2.93	30 x 30 2.87	
5600	562	22 x 30 1.98				22 x 35 2.29	25 x 30 2.37	30 x 25 2.43		22 x 50 3.11	25 x 40 3.11	30 x 35 3.21	
6800	682	22 x 30 2.14				22 x 40 2.61	25 x 35 2.71	30 x 30 2.79		22 x 50 3.11	25 x 50 3.64	30 x 40 3.61	35 x 30 3.53
8200	822	22 x 35 2.42	25 x 30 2.50			22 x 50 3.02	25 x 40 3.02	30 x 30 2.95				30 x 45 3.94	35 x 35 3.87
10000	103	22 x 40 2.77	25 x 35 2.88				25 x 45 3.43	30 x 35 3.38				30 x 50 4.42	35 x 40 4.37
12000	123	22 x 45 3.09	25 x 40 3.22	30 x 30 3.15			25 x 50 3.78	30 x 40 3.75	35 x 30 3.67				35 x 45 4.78
15000	153		25 x 45 3.62	30 x 35 3.57	35 x 30 3.65			30 x 45 4.19	35 x 35 4.12				35 x 50 5.24
18000	183		25 x 50 4.36	30 x 40 3.95	35 x 35 4.06				35 x 40 4.52				35 x 55 5.70
22000	223			30 x 45 4.36	35 x 35 4.28				35 x 45 4.95				
27000	273				35 x 45 4.92								

→ Case size 尺寸
→ Ripple current 紋波電流

WV μF / ∅D		63 (1J)				80 (1K)				100 (2A)			
		22	25	30	35	22	25	30	35	22	25	30	35
820	821					22 x 25 1.37				22 x 30 1.46	25 x 25 1.51		
1000	102					22 x 30 1.62	25 x 25 1.67			22 x 35 1.71	25 x 30 1.77		
1200	122	22 x 25 1.37				22 x 30 1.67	25 x 25 1.72			22 x 40 1.86	25 x 35 1.94	30 x 25 1.88	
1500	152	22 x 30 1.50	25 x 25 1.54			22 x 35 1.98	25 x 30 2.05			22 x 45 2.18	25 x 40 2.28	30 x 30 2.23	
1800	182	22 x 30 1.64	25 x 25 1.69			22 x 40 2.28	25 x 35 2.37	30 x 25 2.30			25 x 45 2.61	30 x 35 2.57	
2200	222	22 x 35 1.86	25 x 30 1.92			22 x 45 2.51	25 x 35 2.49	30 x 30 2.56			25 x 50 2.85	30 x 40 2.83	35 x 30 2.76
2700	272	22 x 40 2.17	25 x 30 2.13	30 x 25 2.18			25 x 45 3.03	30 x 35 2.99				30 x 45 3.27	35 x 30 3.22
3300	332	22 x 50 2.53	25 x 40 2.53	30 x 30 2.48			25 x 50 3.33	30 x 40 3.30	35 x 30 3.23			30 x 50 3.59	35 x 40 3.55
3900	392		25 x 45 2.88	30 x 35 2.84				30 x 45 3.75	35 x 35 3.69				35 x 45 4.03
4700	472		25 x 40 3.20	30 x 40 3.17	35 x 30 3.10			30 x 50 4.90	35 x 40 4.06				35 x 50 4.40
5600	562			30 x 45 3.51	35 x 35 3.46				35 x 45 4.44				35 x 50 4.65
6800	682			30 x 50 3.92	35 x 40 3.88				35 x 50 4.90				35 x 50 5.50
8200	822				35 x 45 4.22								
10000	103				35 x 50 4.74								

→ Case size 尺寸
→ Ripple current 紋波電流

•Case size ∅D×L(mm), ripple current (A rms) at 105°C, 120Hz •尺寸∅D×L(mm), 紋波電流(A rms)於 105°C, 120Hz

Note: All design and specifications are for reference only and is subject to change without prior notice. If any doubt about safety for your application, please contact us immediately for technical assistance before purchase.

注：以上所提供的設計及特性參數僅供參考，任何修改不作預先通知。如果在使用上有疑問，請在採購前與我們聯繫，以便提供技術上的協助。

CAT.2023/V2

SK Series

□ DIMENSIONS & MAXIMUM PERMISSIBLE RIPPLE CURRENT 規格尺寸及最大允許紋波電流

WV		160 (2C)				200 (2D)				250 (2E)			
μF	∅D	22	25	30	35	22	25	30	35	22	25	30	35
150	151									22 x 25 0.68	25 x 20 0.69		
180	181	22 x 20 0.69				22 x 20 0.41				22 x 25 0.74	25 x 30 0.76	30 x 20 0.83	
220	221	22 x 20 0.76				22 x 25 0.48	25 x 20 0.49			22 x 30 0.88	25 x 25 0.90	30 x 20 0.92	
270	271	22 x 25 0.91	25 x 20 0.93			22 x 25 0.53	25 x 25 0.59	30 x 20 0.60		22 x 35 1.03	25 x 30 1.06	30 x 25 1.09	35 x 20 1.11
330	331	22 x 25 1.01	25 x 25 1.10	30 x 20 1.13		22 x 30 0.62	25 x 25 0.64	30 x 20 0.65		22 x 40 1.20	25 x 30 1.18	30 x 25 1.21	35 x 20 1.23
390	391	22 x 30 1.17	25 x 25 1.20	30 x 20 1.23		22 x 40 0.78	25 x 30 0.76	30 x 25 0.78	35 x 20 0.80	22 x 45 1.36	25 x 40 1.42	30 x 30 1.39	35 x 25 1.42
470	471	22 x 35 1.36	25 x 25 1.32	30 x 25 1.44	35 x 20 1.47	22 x 45 0.89	25 x 35 0.88	30 x 30 0.91	35 x 20 0.87	22 x 50 1.56	25 x 40 1.56	30 x 30 1.53	35 x 25 1.56
560	561	22 x 40 1.56	25 x 30 1.53	30 x 25 1.57	35 x 25 1.70	22 x 50 1.03	25 x 40 1.03	30 x 30 1.00	35 x 25 1.03		25 x 50 1.86	30 x 35 1.76	35 x 30 1.80
680	681	22 x 45 1.80	25 x 35 1.79	30 x 25 1.73	35 x 25 1.88		25 x 45 1.19	30 x 35 1.17	35 x 30 1.20			30 x 45 2.12	35 x 35 2.09
820	821	22 x 50 2.06	25 x 40 2.06	30 x 30 2.02	35 x 25 2.06			30 x 40 1.36	35 x 35 1.40				35 x 40 2.40
1000	102		25 x 45 2.38	30 x 35 2.35	35 x 30 2.41			30 x 45 1.54	35 x 40 1.59				35 x 45 2.76
1200	122		25 x 50 2.52	30 x 40 2.50	35 x 30 2.44				35 x 50 2.06				35 x 50 2.91
1500	152				35 x 40 3.00	→ Case size 尺寸							
						→ Ripple current 紋波電流							

WV		315 (2F)				350 (2V)				400 (2G)			
μF	∅D	22	25	30	35	22	25	30	35	22	25	30	35
56	560									22 x 20 0.37			
68	680					22 x 20 0.41				22 x 25 0.44	25 x 20 0.45		
82	820	22 x 20 0.45				22 x 25 0.48	25 x 20 0.49			22 x 30 0.51	25 x 25 0.53	30 x 20 0.54	
100	101	22 x 25 0.53	25 x 20 0.55			22 x 25 0.53	25 x 25 0.59	30 x 20 0.60		22 x 35 0.60	25 x 30 0.62	30 x 20 0.60	
120	121	22 x 30 0.62	25 x 25 0.64	30 x 20 0.65		22 x 30 0.62	25 x 25 0.64	30 x 20 0.65		22 x 40 0.69	25 x 30 0.68	30 x 25 0.70	35 x 20 0.71
150	151	22 x 35 0.74	25 x 30 0.76	30 x 20 0.73		22 x 40 0.78	25 x 30 0.76	30 x 25 0.78	35 x 20 0.80	22 x 45 0.81	25 x 35 0.81	30 x 30 0.83	35 x 20 0.80
180	181	22 x 40 0.85	25 x 35 0.88	30 x 25 0.86	35 x 20 0.87	22 x 45 0.89	25 x 35 0.88	30 x 30 0.91	35 x 20 0.87	22 x 50 0.93	25 x 40 0.93	30 x 30 0.91	35 x 25 0.93
220	221	22 x 45 0.98	25 x 35 0.98	30 x 30 1.00	35 x 20 0.96	22 x 50 1.03	25 x 40 1.03	30 x 30 1.00	35 x 25 1.03		25 x 45 1.07	30 x 35 1.06	35 x 30 1.08
270	271		25 x 45 1.19	30 x 35 1.17	35 x 25 1.14		25 x 45 1.19	30 x 35 1.17	35 x 30 1.20		25 x 50 1.24	30 x 40 1.23	35 x 30 1.20
330	331		25 x 50 1.37	30 x 40 1.36	35 x 30 1.33			30 x 40 1.36	35 x 35 1.40		25 x 45 1.36	30 x 45 1.42	35 x 35 1.40
390	391			30 x 45 1.54	35 x 35 1.52			30 x 45 1.54	35 x 40 1.59			30 x 50 1.61	35 x 40 1.59
470	471			30 x 50 1.76	35 x 40 1.74				35 x 45 1.82				35 x 45 1.82
560	561				35 x 40 1.90				35 x 50 2.06				35 x 50 2.06
680	681				35 x 50 2.27	→ Case size 尺寸							35 x 50 2.15
						→ Ripple current 紋波電流							

WV		450 (2W)			
μF	∅D	22	25	30	35
47	470	22 x 20 0.34			
56	560	22 x 25 0.40	25 x 20 0.41		
68	680	22 x 30 0.47	25 x 25 0.48	30 x 20 0.49	
82	820	22 x 35 0.54	25 x 30 0.56	30 x 20 0.54	
100	101	22 x 40 0.63	25 x 30 0.62	30 x 25 0.64	35 x 20 0.65
120	121	22 x 45 0.73	25 x 35 0.72	30 x 30 0.74	35 x 25 0.76
150	151	22 x 50 0.85	25 x 40 0.85	30 x 30 0.83	35 x 25 0.85
180	181		25 x 45 0.97	30 x 35 0.96	35 x 30 0.98
220	221		25 x 50 1.12	30 x 40 1.11	35 x 30 1.08
270	270			30 x 45 1.28	35 x 35 1.26
330	331			30 x 50 1.48	35 x 40 1.46
390	391				35 x 45 1.66
470	471				35 x 45 1.85

→ Case size ∅D×L(mm)
→ Ripple current (A rms) at 105°C, 120Hz

→ 尺寸∅D×L(mm)
→ 紋波電流(A rms)於 105°C, 120Hz

- Please refer to page 20 "Packaging Specifications" for the minimum package quantity. 最小包裝數量請查閱第 20 頁 "包裝標準"。
- Please refer to page 16 for the Part Number System. 產品編碼規則請查閱第 16 頁。

Note: All design and specifications are for reference only and is subject to change without prior notice. If any doubt about safety for your application, please contact us immediately for technical assistance before purchase.

注：以上所提供的設計及特性參數僅供參考，任何修改不作預先通知。如果在使用上有疑問，請在採購前與我們聯繫，以便提供技術上的協助。

CAT.2023/V2

SP Series

SNAP-IN TERMINAL TYPE, LONG LIFE

導箔型, 長壽命品



- Endurance 3000 hours at 85°C
在 85°C 環境中耐久性 3000 小時
- Long life
長壽命
- Comply with the RoHS & REACH
符合 RoHS 與 REACH

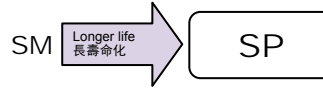

□ SPECIFICATIONS 特性表

Items 項目	Characteristics 主要特性	
Category Temperature Range 工作溫度範圍	-40 ~ +85°C	-25 ~ +85°C
Voltage Range 額定工作電壓範圍	16 ~ 350V	400 ~ 450V
Capacitance Range 靜電容量範圍	82 ~ 68000µF	56 ~ 560µF
Capacitance Tolerance 靜電容量允許偏差	±20% at 120Hz, 20°C	
Leakage Current 漏電流	$I \leq 3\sqrt{CV}$ (after 5 minutes application of rated voltage at 20°C) (在 20°C 環境中施加額定工作電壓 5 分鐘後) I: Leakage current (µA) 漏電流, C: Nominal capacitance (µF) 標稱靜電容量, V: Rated voltage (V) 額定電壓	
Dissipation Factor (tan δ) 損耗角正切	When nominal capacitance is over 1000µF, tan δ shall be added 0.01 to the listed value with increase of every 1000µF. 當標稱靜電容量大於 1000µF, 其標稱靜電容量每增加 1000µF, 損耗角正切增加 0.01。 Measurement frequency 測試頻率: 120Hz, Temperature 溫度: 20°C	
Stability at Low Temperature 低溫特性	Measurement frequency 測試頻率: 120Hz	
	Rated Voltage (V) 額定工作電壓	16 25~35 50~63 80~100 160~350 400, 450
Endurance 耐久性	After 3000 hours application of the rated voltage at 85°C, they meet the characteristics listed below. 在 85°C 環境中施加額定工作電壓 3000 小時後, 電容器的特性符合下表的要求。	
	Capacitance Change 靜電容量變化率	Within ±20% of initial value 初始值的±20%以內
Shelf Life 高溫貯存特性	After leaving capacitors under no load at 85°C for 1000 hours, they meet the specified listed below. 在 85°C 環境中無負荷放置 1000 小時後, 電容器的特性符合下表的要求。	
	Capacitance Change 靜電容量變化率	Within ±20% of initial value 初始值的±20%以內
Marking 標識	Printed with white colour on black sleeve (PVC) or printed with white colour on green sleeve (PET). 黑色膠管白字印刷 (PVC) 或綠色膠管白字印刷 (PET)。	

□ DRAWING & DIMENSIONS 外形圖及尺寸 (Unit: mm)

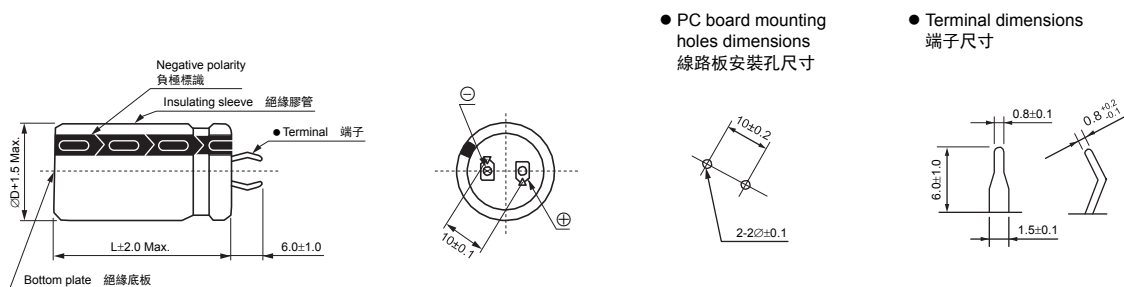

□ FREQUENCY COEFFICIENT OF ALLOWABLE RIPPLE CURRENT 紋波電流頻率補償係數

Frequency 頻率	50Hz	120Hz	300Hz	1KHz	10KHz~	
Coefficient 係數	~ 100µF	0.88	1.0	1.06	1.15	1.20
	160 ~ 250µF	0.85	1.0	1.20	1.25	1.45
	315µF ~	0.88	1.0	1.15	1.20	1.40

The endurance of capacitors is reduced with internal heating produced by ripple current at the rate of halving the lifetime with every 5~10°C rise. When long life performance is required in actual use, the rms ripple current has to be reduced. 鋁電解電容器在疊加紋波電流後會引起發熱, 溫度每上升 5~10°C 壽命會減半。若要保持長壽命性能, 請在使用過程中適當降低紋波電流。

Note: All design and specifications are for reference only and is subject to change without prior notice. If any doubt about safety for your application, please contact us immediately for technical assistance before purchase.
 注: 以上所提供的設計及特性參數僅供參考, 任何修改不作預先通知。如果在使用上有疑問, 請在採購前與我們聯繫, 以便提供技術上的協助。

CAT.2023/V2

SP Series

□ DIMENSIONS & MAXIMUM PERMISSIBLE RIPPLE CURRENT 規格尺寸及最大允許紋波電流

WV		16 (1C)				25 (1E)				35 (1V)			
μF	∅D	22	25	30	35	25	30	22	35	30	22	25	35
4700	472									22 x 25 2.21	25 x 25 2.42		
5600	562					22 x 25 2.31				22 x 30 2.69	25 x 25 2.69		
6800	682					22 x 25 2.38	25 x 25 2.78			22 x 35 2.70	25 x 25 2.67	30 x 25 2.99	
8200	822	22 x 25 2.56				22 x 25 2.43	25 x 25 2.85			22 x 35 3.09	25 x 30 3.12	30 x 25 3.04	
10000	103	22 x 25 2.60	25 x 25 2.81			22 x 30 2.97	25 x 25 2.93	30 x 25 3.21		22 x 40 3.22	25 x 35 3.37	30 x 25 3.36	35 x 25 3.32
12000	123	22 x 25 2.88	25 x 25 2.96			22 x 35 3.33	25 x 30 3.26	30 x 25 3.59	35 x 25 3.58	22 x 45 3.71	25 x 40 3.79	30 x 30 3.74	35 x 25 3.75
15000	153	22 x 30 3.45	25 x 25 3.38	30 x 25 3.73		22 x 40 3.68	25 x 35 3.77	30 x 25 3.60	35 x 25 3.96		25 x 45 4.55	30 x 35 4.54	35 x 25 4.37
18000	183	22 x 30 3.47	25 x 25 3.47			22 x 45 4.36	25 x 35 4.20	30 x 30 4.40	35 x 25 4.34		25 x 50 4.84	30 x 40 4.87	35 x 30 5.03
22000	223	22 x 35 3.84	25 x 30 3.93	30 x 25 4.08	35 x 25 4.15		25 x 45 4.71	30 x 35 4.70	35 x 25 4.60			30 x 45 5.79	35 x 55 5.71
27000	273	22 x 45 4.63	25 x 40 4.72					30 x 45 5.79	35 x 35 5.71				35 x 45 6.81
33000	333	22 x 50 5.20	25 x 45 5.41	30 x 35 5.40	35 x 25 5.19				35 x 40 6.31				
39000	393			30 x 40 6.02	35 x 30 5.88				35 x 45 6.92	→ Case size 尺寸 → Ripple current 紋波電流			
47000	473			30 x 45 6.95	35 x 35 6.85								
56000	563				35 x 40 7.39								
68000	683				35 x 45 8.06								

WV		50 (1H)				63 (1J)				80 (1K)			
μF	∅D	22	25	30	35	22	25	30	35	22	25	30	35
1200	122									22 x 25 1.62			
1500	152									22 x 25 1.81			
1800	182					22 x 25 1.90				22 x 30 2.14	25 x 25 2.14		
2200	222	22 x 25 1.93				22 x 30 2.35	25 x 25 2.30			22 x 35 2.37	25 x 30 2.39	30 x 25 2.48	
2700	272	22 x 25 2.05				22 x 35 2.50	25 x 25 2.34			22 x 40 2.78	25 x 35 2.82	30 x 25 2.74	
3300	332	22 x 30 2.41	25 x 25 2.38			22 x 35 2.62	25 x 30 2.69	30 x 25 2.78		22 x 45 3.14	25 x 40 3.20	30 x 30 3.16	35 x 25 3.24
3900	392	22 x 30 2.51	25 x 25 2.46			22 x 40 2.90	25 x 35 3.09	30 x 30 3.09		22 x 50 3.58	25 x 45 3.67	30 x 35 3.66	35 x 25 3.52
4700	472	22 x 35 2.83	25 x 30 3.03	30 x 25 3.01		22 x 50 3.49	25 x 40 3.37	30 x 30 3.37	35 x 25 3.36		25 x 50 4.10	30 x 40 4.13	35 x 30 4.03
5600	562	22 x 40 3.21	25 x 35 3.37	30 x 25 3.17	35 x 25 3.47		25 x 45 3.77	30 x 35 3.75	35 x 30 3.88			30 x 45 4.61	35 x 35 4.54
6800	682	22 x 45 3.73	25 x 35 3.59	30 x 30 3.56	35 x 25 3.64		25 x 50 4.41	30 x 40 4.41	35 x 30 4.04			30 x 50 5.18	35 x 40 5.15
8200	822		25 x 40 4.10	30 x 30 4.12	35 x 25 4.07								35 x 45 5.80
10000	103		25 x 50 4.91	30 x 35 4.68	35 x 30 4.59			30 x 50 5.49	35 x 40 5.47				35 x 50 6.69
12000	123			30 x 40 5.10	35 x 35 5.30				35 x 45 5.97	→ Case size 尺寸 → Ripple current 紋波電流			
15000	153			30 x 50 6.28	35 x 40 6.24								
18000	183				35 x 45 7.18								

•Case size ∅DxL(mm), ripple current (A rms) at 85°C, 120Hz •尺寸∅DxL(mm), 紋波電流(A rms)於 85°C, 120Hz

Note: All design and specifications are for reference only and is subject to change without prior notice. If any doubt about safety for your application, please contact us immediately for technical assistance before purchase.

注：以上所提供的設計及特性參數僅供參考，任何修改不作預先通知。如果在使用上有疑問，請在採購前與我們聯繫，以便提供技術上的協助。

CAT.2023/V2

SP Series

□ DIMENSIONS & MAXIMUM PERMISSIBLE RIPPLE CURRENT 規格尺寸及最大允許紋波電流

WV		100 (2A)				160 (2C)				200 (2D)			
μF	∅D	22	25	30	35	22	25	30	35	22	25	30	35
220	221									22 x 25 1.15			
270	271					22 x 25 1.27				22 x 25 1.30			
330	331					22 x 25 1.40				22 x 25 1.40	25 x 25 1.43		
390	391					22 x 30 1.62				22 x 25 1.42	25 x 25 1.63		
470	471					22 x 30 1.77	25 x 25 1.77			22 x 30 1.68	25 x 25 1.68	30 x 25 1.85	
560	561					22 x 30/35 1.92/2.05	25 x 25 1.92	30 x 25 2.02		22 x 35 1.97	25 x 30 2.05	30 x 25 2.05	
680	681					22 x 35 2.12	25 x 30 2.22	30 x 25 2.22		22 x 40 2.24	25 x 30 2.13	30 x 25 2.21	35 x 25 2.10
820	821					22 x 40 2.32	25 x 30 2.32	30 x 25 2.31	35 x 25 2.50	22 x 45 2.32	25 x 35 2.23	30 x 30 2.62	35 x 25 2.39
1000	102					22 x 50 2.88	25 x 40 2.86	30 x 30 2.82	35 x 25 2.79	22 x 50 2.57	25 x 40 2.50	30 x 30 2.47	35 x 25 2.53
1200	122	22 x 30 2.12	25 x 25 2.10				25 x 45 3.27	30 x 35 3.25	35 x 30 3.24		25 x 45 2.89	30 x 35 2.88	35 x 30 2.97
1500	152	22 x 35 2.45	25 x 30 2.43	30 x 25 2.46				30 x 40 3.77	35 x 35 3.75		25 x 55 3.41	30 x 45 3.46	35 x 35 3.42
1800	182	22 x 40 2.77	25 x 35 2.77	30 x 25 2.65				30 x 45 4.10	35 x 35 4.08			30 x 50 3.97	35 x 40 3.95
2200	222	22 x 45 3.12	25 x 40 3.20	30 x 30 3.10	35 x 25 3.14				35 x 45 4.72			30 x 60 4.51	35 x 45 4.35
2700	272		25 x 45 3.61	30 x 35 3.60	35 x 30 3.71				35 x 55 5.53				35 x 55 4.79
3300	332		25 x 50 4.06	30 x 40 4.05	35 x 35 4.07								
3900	392			30 x 45 4.60	35 x 35 4.50								
4700	472			30 x 50 5.13	35 x 40 5.12								
5600	562				35 x 45 5.75	→ Case size 尺寸 → Ripple current 紋波電流							
6800	682				35 x 50 6.01								

WV		250 (2E)				350 (2V)				400 (2G)			
μF	∅D	22	25	30	35	22	25	30	35	22	25	30	35
68	680									22 x 25 0.72			
82	820					22 x 25 0.70				22 x 25 0.80			
100	101					22 x 25 0.77	25 x 20 0.73			22 x 25 0.81	25 x 20 0.79		
120	121					22 x 25 0.99	25 x 20 0.80			22 x 30 1.04	25 x 25 1.06		
150	151						25 x 25 1.00	30 x 25 1.04		22 x 30 1.06	25 x 25 1.06	30 x 25 1.24	
180	181	22 x 25 1.01				22 x 35 1.15	25 x 30 1.20	30 x 25 1.37		22 x 35 1.16	25 x 30 1.23	30 x 25 1.45	35 x 25 1.54
220	221	22 x 25 1.18	25 x 25 1.24			22 x 40 1.30	25 x 30 1.28	30 x 25 1.37		22 x 40 1.39	25 x 30 1.33	30 x 25 1.38	35 x 25 1.44
270	271	22 x 25 1.21	25 x 25 1.30			22 x 45 1.42	25 x 35 1.40	30 x 30 1.41	35 x 25 1.42	22 x 45 1.54	25 x 35 1.48	30 x 30 1.56	35 x 25 1.53
330	331	22 x 35 1.35	25 x 30 1.38	30 x 25 1.40		22 x 50 1.69	25 x 40 1.64	30 x 30 1.64	35 x 25 1.77	22 x 50 1.70	25 x 45 1.76	30 x 35 1.76	35 x 30 1.68
390	391	22 x 40 1.57	25 x 30 1.57	30 x 25 1.58			25 x 45 1.84	30 x 35 1.88	35 x 30 1.90		25 x 45 1.86	30 x 40 1.89	35 x 35 1.97
470	471	22 x 40 1.72	25 x 35 1.73	30 x 30 1.80				30 x 40 1.91	35 x 30 1.95			30 x 45 2.18	35 x 40 2.12
560	561	22 x 45 2.02	25 x 40 2.04	30 x 35 2.01	35 x 30 2.11			30 x 45 2.15	35 x 40 2.20				35 x 45 2.20
680	681	22 x 50 2.48	25 x 45 2.54	30 x 30 2.38	35 x 30 2.54								
820	821		25 x 50 2.92	30 x 45 2.78	35 x 40 2.87								
1000	102		25 x 55 3.06	30 x 50 3.11	35 x 45 3.06								
1200	122				35 x 50 3.20	→ Case size 尺寸 → Ripple current 紋波電流							
1500	152			30 x 60 4.06	35 x 55 3.92								

•Case size ∅DxL(mm), ripple current (A rms) at 85°C, 120Hz •尺寸∅DxL(mm), 紋波電流(A rms)於 85°C, 120Hz

Note: All design and specifications are for reference only and is subject to change without prior notice. If any doubt about safety for your application, please contact us immediately for technical assistance before purchase.

注：以上所提供的設計及特性參數僅供參考，任何修改不作預先通知。如果在使用上有疑問，請在採購前與我們聯繫，以便提供技術上的協助。

CAT.2023/V2

SP Series

□ DIMENSIONS & MAXIMUM PERMISSIBLE RIPPLE CURRENT 規格尺寸及最大允許紋波電流

WV μF		450 (2W)			
		22	25	30	35
56	560	22 x 25 0.68			
68	680	22 x 20 0.58			
82	820	22 x 25 0.69	25 x 25 0.75		
100	101	22 x 25 0.77	25 x 25 0.83		
120	121	22 x 35 0.97	25 x 25 0.91	30 x 25 1.10	
150	151	22 x 35 1.20	25 x 30 1.16	30 x 25 1.16	
180	181	22 x 40 1.21	25 x 35 1.31	30 x 30 1.19	35 x 25 1.35
220	221	22 x 50 1.48	25 x 40 1.47	30 x 35 1.42	35 x 30 1.45
270	270		25 x 45 1.59	30 x 35 1.69	35 x 30 1.61
330	331		25 x 50 1.76	30 x 40 1.93	35 x 35 1.88
390	391			30 x 45 2.00	35 x 40 1.95
470	471			30 x 50 2.15	35 x 45 2.10
560	561				35 x 50 2.26

→ Case size $\varnothing D \times L$ (mm)
→ Ripple current (A rms) at 85°C, 120Hz

→ 尺寸 $\varnothing D \times L$ (mm)
→ 紋波電流(A rms)於 85°C, 120Hz

- Please refer to page 20 "Packaging Specifications" for the minimum package quantity. 最小包裝數量請查閱第 20 頁“包裝標準”。
- Please refer to page 16 for the Part Number System. 產品編碼規則請查閱第 16 頁。

Note: All design and specifications are for reference only and is subject to change without prior notice. If any doubt about safety for your application, please contact us immediately for technical assistance before purchase.

注：以上所提供的設計及特性參數僅供參考，任何修改不作預先通知。如果在使用上有疑問，請在採購前與我們聯繫，以便提供技術上的協助。

CAT.2023/V2

SH Series

SNAP-IN TERMINAL TYPE, LONG LIFE

導箔型, 長壽命品

- Endurance 3000 hours
耐久性 3000 小時
- Long life
長壽命
- Comply with the RoHS & REACH
符合 RoHS 與 REACH

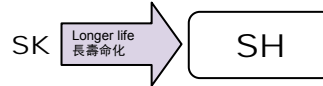

□ SPECIFICATIONS 特性表

Items 項目	Characteristics 主要特性	
Category Temperature Range 工作溫度範圍	-40 ~ +105°C	-25 ~ +105°C
Voltage Range 額定工作電壓範圍	16 ~ 350V	400 ~ 450V
Capacitance Range 靜電容量範圍	100 ~ 22000µF	100 ~ 680µF
Capacitance Tolerance 靜電容量允許偏差	±20% at 120Hz, 20°C	
Leakage Current 漏電流	$I \leq 3\sqrt{CV}$ (after 5 minutes application of rated voltage at 20°C) (在 20°C 環境中施加額定工作電壓 5 分鐘後) I: Leakage current (µA) 漏電流, C: Nominal capacitance (µF) 標稱靜電容量, V: Rated voltage (V) 額定電壓	
Dissipation Factor (tan δ) 損耗角正切	When nominal capacitance is over 1000µF, tan δ shall be added 0.01 to the listed value with increase of every 1000µF. 當標稱靜電容量大於 1000µF, 其標稱靜電容量每增加 1000µF, 損耗角正切增加 0.01. Measurement frequency 測試頻率: 120Hz, Temperature 溫度: 20°C	
Stability at Low Temperature 低溫特性	Measurement frequency 測試頻率: 120Hz	
	Rated Voltage (V) 額定工作電壓	16 25 35 50 63 80 100 160~250 350~450
Endurance 耐久性	Capacitance Change 靜電容量變化率	tan δ (max.) 最大損耗角正切
	Dissipation Factor 損耗角正切	Leakage Current 漏電流
Shelf Life 高溫貯存特性	Capacitance Change 靜電容量變化率	Dissipation Factor 損耗角正切
	Dissipation Factor 損耗角正切	Leakage Current 漏電流
Marking 標識	Printed with white colour on black sleeve (PVC) or printed with white colour on green sleeve (PET). 黑色膠管白字印刷 (PVC) 或綠色膠管白字印刷 (PET)。	

□ DRAWING & DIMENSIONS 外形圖及尺寸 (Unit: mm)

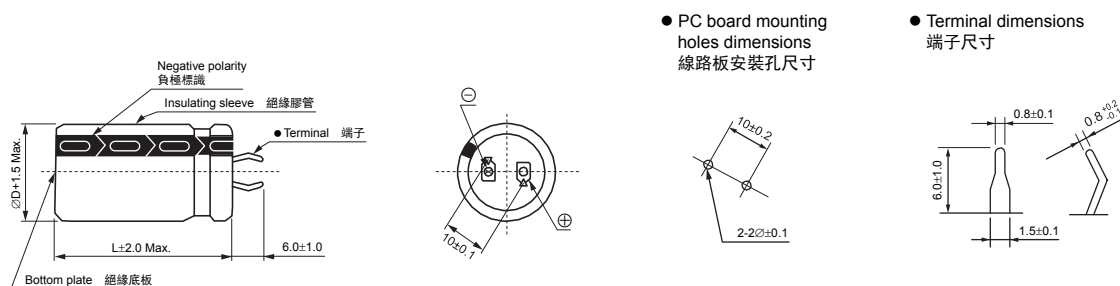

□ FREQUENCY COEFFICIENT OF ALLOWABLE RIPPLE CURRENT 紋波電流頻率補償系數

Frequency 頻率		50Hz	120Hz	300Hz	1KHz	10KHz~
Coefficient 系數	~ 100µF	0.88	1.0	1.06	1.15	1.20
	160 ~ 250µF	0.85	1.0	1.20	1.25	1.45
	315µF ~	0.88	1.0	1.15	1.20	1.40

The endurance of capacitors is reduced with internal heating produced by ripple current at the rate of halving the lifetime with every 5~10°C rise. When long life performance is required in actual use, the rms ripple current has to be reduced. 鋁電解電容器在疊加紋波電流後會引起發熱, 溫度每上升 5~10°C 壽命會減半。若要保持長壽命性能, 請在使用過程中適當降低紋波電流。

Note: All design and specifications are for reference only and is subject to change without prior notice. If any doubt about safety for your application, please contact us immediately for technical assistance before purchase.
注: 以上所提供的設計及特性參數僅供參考, 任何修改不作預先通知。如果在使用上有疑問, 請在採購前與我們聯繫, 以便提供技術上的協助。

CAT.2023/V2

SH Series

□ DIMENSIONS & MAXIMUM PERMISSIBLE RIPPLE CURRENT 規格尺寸及最大允許紋波電流

WV μF / ∅D		16 (1C)				25 (1E)				35 (1V)			
		22	25	30	35	22	25	30	35	22	25	30	35
2200	222									22 x 25 1.14	25 x 25 1.51		
3300	332					22 x 25 1.25				22 x 30 1.51	25 x 30 1.92		
4700	472	22 x 25 1.30				22 x 30 1.61	25 x 25 1.61			22 x 35 1.92	25 x 40 2.31	30 x 25 1.92	
6800	682	22 x 35 1.80	25 x 30 1.80			22 x 35 1.91	25 x 30 1.91	30 x 25 1.91		22 x 45 2.31	25 x 45 2.87	30 x 30 2.33	
10000	103	22 x 45 2.34	25 x 35 2.25	30 x 25 2.19		22 x 45 2.51	25 x 40 2.42	30 x 30 2.42	35 x 25 2.42			30 x 35 2.87	35 x 30 2.87
15000	153		25 x 45 2.83	30 x 35 2.82	35 x 30 2.82		25 x 45 3.12	30 x 35 3.11	35 x 30 3.11			30 x 45 3.66	35 x 40 3.66
22000	223			30 x 45 3.13	35 x 35 3.09			30 x 45 3.85	35 x 40 3.85	→ Case size 尺寸 → Ripple current 紋波電流			35 x 45 4.53

WV μF / ∅D		50 (1H)				63 (1J)				80 (1K)			
		22	25	30	35	22	25	30	35	22	25	30	35
1000	102					22 x 20 0.90				22 x 25 1.05	25 x 20 1.04		
1200	122					22 x 20 1.05				22 x 30 1.24	25 x 25 1.24		
1500	152	22 x 25 1.22				22 x 25 1.28	25 x 20 1.27			22 x 35 1.54	25 x 30 1.54	30 x 25 1.61	
2200	222	22 x 30 1.59	25 x 25 1.59			22 x 35 1.78	25 x 25 1.60	30 x 25 1.78		22 x 45 1.95	25 x 35 1.94	30 x 30 2.05	35 x 25 2.10
2700	272					22 x 35 1.81	25 x 30 1.83	30 x 25 1.89					
3300	332	22 x 35 1.93	25 x 30 1.88	30 x 25 1.88		22 x 40 2.00	25 x 35 2.03	30 x 30 1.81	35 x 25 2.03		25 x 50 2.25	30 x 35 2.24	35 x 30 2.30
3900	392					22 x 50 2.37	25 x 40 2.22	30 x 30 2.19	35 x 25 2.24				
4700	472	22 x 45 2.43	25 x 35 2.34	30 x 30 2.42	35 x 25 2.42		25 x 45 2.56	30 x 35 2.66	35 x 30 2.46			30 x 45 2.84	35 x 35 2.80
5600	562						25 x 50 2.93	30 x 35 2.79	35 x 30 2.88				
6800	682		25 x 45 3.10	30 x 35 3.10	35 x 30 3.10			30 x 40 3.25	35 x 35/40 3.26/3.49				35 x 35 3.50
8200	822								35 x 40 3.52	→ Case size 尺寸 → Ripple current 紋波電流			
10000	103			30 x 45 4.18	35 x 40 4.20								35 x 70 4.45

WV μF / ∅D		100 (2A)				160 (2C)				200 (2D)			
		22	25	30	35	22	25	30	35	22	25	30	35
180	181									22 x 20 0.70			
220	221					22 x 20 0.71					25 x 20 0.84		
270	271						25 x 20 0.85			22 x 25 1.03			
330	331					22 x 25 0.98	25 x 20 0.94			22 x 30 1.21			
390	391					22 x 25 1.03	25 x 25 1.09			22 x 35 1.39	25 x 25 1.31		
470	471					22 x 30 1.21	25 x 25 1.19			22 x 35 1.52	25 x 30 1.52		
560	561					22 x 35 1.40	25 x 30 1.40	30 x 25 1.40		22 x 40 1.66	25 x 35 1.75	30 x 25 1.64	
680	681					22 x 40 1.62	25 x 35 1.61	30 x 25 1.54		22 x 45 2.04	25 x 40 2.04	30 x 30 1.96	
820	82					22 x 45 1.86	25 x 40 1.86	30 x 30 1.79	35 x 25 1.79		25 x 45 2.34	30 x 35 2.27	
1000	102	22 x 30 1.36	25 x 25 1.36			22 x 50 1.91	25 x 45 2.15	30 x 35 2.09	35 x 30 1.98		25 x 50 2.46		
1200	122	22 x 35 1.48	25 x 30 1.49				25 x 50 2.35	30 x 40 2.35	35 x 35 2.29				
1500	152	22 x 40 1.82	25 x 35 1.85	30 x 25 1.80				30 x 45 2.56	35 x 40 2.72				35 x 50 2.85
1800	182								35 x 45 3.09				
2200	222		25 x 45 2.50	30 x 35 2.50	35 x 30 2.50				35 x 55 3.51				
2700	272		25 x 50 2.70	30 x 40 2.72	35 x 35 2.82				35 x 60 4.05	→ Case size 尺寸 → Ripple current 紋波電流			
3300	102			30 x 45 3.11	35 x 35 3.07								
3900	122			30 x 50 3.40	35 x 40 3.38								
4700	152				35 x 45 3.90								

•Case size ∅D×L(mm), ripple current (A rms) at 105°C, 120Hz •尺寸∅D×L(mm), 紋波電流(A rms)於 105°C, 120Hz

Note: All design and specifications are for reference only and is subject to change without prior notice. If any doubt about safety for your application, please contact us immediately for technical assistance before purchase.

注：以上所提供的設計及特性參數僅供參考，任何修改不作預先通知。如果在使用上有疑問，請在採購前與我們聯繫，以便提供技術上的協助。

CAT.2023/V2

SH Series

□ DIMENSIONS & MAXIMUM PERMISSIBLE RIPPLE CURRENT 規格尺寸及最大允許紋波電流

WV μF / ∅D		250 (2E)				350 (2V)				400 (2G)			
		22	25	30	35	22	25	30	35	22	25	30	35
56	560									22x 20 0.41			
68	680									22x 25 0.52	25 x 20 0.49		
100	101					22 x 25 0.52	25 x 20 0.52			22x 30 0.67			
120	121					22 x 30 0.62	25 x 25 0.65			22x 35 0.78	25 x 25 0.69		
150	151					22 x 35 0.74				22x 40 0.91	25 x 30 0.83	30 x 25 0.86	
180	181	22 x 25 0.77				22 x 40 0.81	25 x 30 0.77	30 x 25 0.80		22x 40 1.04	25 x 35 0.97		
220	221	22 x 30 0.80	25 x 25 0.82			22 x 45 0.94	25 x 35 0.91			22x 50 1.17	25 x 40 1.14	30 x 30 1.12	35 x 25 1.15
270	271	22 x 30 1.02	25 x 25 1.08			22 x 50 1.09	25 x 40 1.06	30 x 30 1.05	35 x 25 1.08		25 x 50 1.40	30 x 35 1.39	35 x 30 1.31
330	331	22 x 35 1.20	25 x 30 1.27	30 x 25 1.34			25 x 45 1.24	30 x 35 1.23	35 x 30 1.23			30 x 40 1.27	35 x 30 1.27
390	391	22 x 40 1.38	25 x 35 1.46	30 x 25 1.39				30 x 40 1.42	35 x 30 1.39			30 x 45 1.49	35 x 35 1.47
470	471	22 x 45 1.46	25 x 40 1.49	30 x 30 1.50				30 x 45 1.51	35 x 35 1.51			30 x 50 1.52	35 x 40 1.53
560	561		25 x 45 1.63	30 x 40 1.66	35 x 30 1.68			30 x 50 1.78	35 x 40 1.77				35 x 50 1.80
680	681		25 x 50 2.04	30 x 35 2.06	35 x 30 2.06			30 x 60 1.94	35 x 50 1.95	→ Case size 尺寸 → Ripple current 紋波電流			
820	821			30 x 45 2.30	35 x 40 2.31								
1000	102			30 x 50 2.63	35 x 40 2.76								
1200	122				35 x 50 2.92								
1500	152				35 x 60 3.34								

WV μF / ∅D		450 (2W)			
		22	25	30	35
82	820		25 x 25 0.57		
100	101	22 x 35 0.67			
120	121	22 x 40 0.78	25 x 30 0.74	30 x 25 0.77	
150	151	22 x 45 0.92	25 x 35 0.89	30 x 30 0.93	35 x 25 0.95
180	181	22 x 50 1.06	25 x 40 1.03	30 x 30 1.01	35 x 25 1.04
220	221		25 x 45 1.18	30 x 35 1.18	35 x 30 1.22
270	271			30 x 40 1.17	
330	331			30 x 50 1.32	35 x 40 1.64
390	391				35 x 40 1.50
470	471				35 x 50 1.65

→ Case size ∅D×L(mm)
→ Ripple current (A rms) at 105°C, 120Hz

→ 尺寸∅D×L(mm)
→ 紋波電流(A rms)於 105°C, 120Hz

- Please refer to page 20 "Packaging Specifications" for the minimum package quantity. 最小包裝數量請查閱第 20 頁 "包裝標準"。
- Please refer to page 16 for the Part Number System. 產品編碼規則請查閱第 16 頁。

Note: All design and specifications are for reference only and is subject to change without prior notice. If any doubt about safety for your application, please contact us immediately for technical assistance before purchase.

注：以上所提供的設計及特性參數僅供參考，任何修改不作預先通知。如果在使用上有疑問，請在採購前與我們聯繫，以便提供技術上的協助。

CAT.2023/V2

ST Series

SNAP-IN TERMINAL TYPE, LOW IMPEDANCE

導箔型, 低阻抗品



- Low impedance, high reliability
低阻抗, 高信賴性
- Endurance 3000~5000 hours
耐久性 3000~5000 小時
- Comply with the RoHS & REACH
符合 RoHS 與 REACH

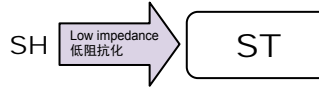

□ SPECIFICATIONS 特性表

Items 項目	Characteristics 主要特性	
Category 工作溫度範圍	-40 ~ +105°C	-25 ~ +105°C
Voltage Range 額定工作電壓範圍	16 ~ 100V	160 ~ 450V
Capacitance Range 靜電容量範圍	1000 ~ 22000µF	220 ~ 4700µF
Capacitance Tolerance 靜電容量允許偏差	±20% at 120Hz, 20°C	
Leakage Current 漏電流	$I \leq 3\sqrt{CV}$ (after 5 minutes application of rated voltage at 20°C) (在 20°C 環境中施加額定工作電壓 5 分鐘後) I: Leakage current (µA) 漏電流, C: Nominal capacitance (µF) 標稱靜電容量, V: Rated voltage (V) 額定電壓	
Dissipation Factor (tan δ) 損耗角正切	When nominal capacitance is over 1000µF, tan δ shall be added 0.01 to the listed value with increase of every 1000µF. 當標稱靜電容量大於 1000µF, 其標稱靜電容量每增加 1000µF, 損耗角正切增加 0.01. Measurement frequency 測試頻率: 120Hz, Temperature 溫度: 20°C	
Stability at Low Temperature 低溫特性	Rated Voltage (V) 額定工作電壓	16 25 35 50 63 80 100 160~250 350~450
	tan δ (max.) 最大損耗角正切	0.50 0.45 0.40 0.35 0.30 0.25 0.20 0.10 0.15
Endurance 耐久性	Capacitance Change 靜電容量變化率	Within ±20% of initial value 初始值的±20%以內
	Dissipation Factor 損耗角正切	Less than 200% of specified value 不大於規範值的 200%
Shelf Life 高溫貯存特性	Capacitance Change 靜電容量變化率	Within ±15% of initial value 初始值的±15%以內
	Dissipation Factor 損耗角正切	Less than 130% of specified value 不大於規範值的 130%
Marking 標識	Leakage Current 漏電流	Less than specified value 不大於規範值
	Printed with white colour on black sleeve (PVC) or printed with white colour on green sleeve (PET). 黑色膠管白字印刷 (PVC) 或綠色膠管白字印刷 (PET).	

□ DRAWING & DIMENSIONS 外形圖及尺寸 (Unit: mm)

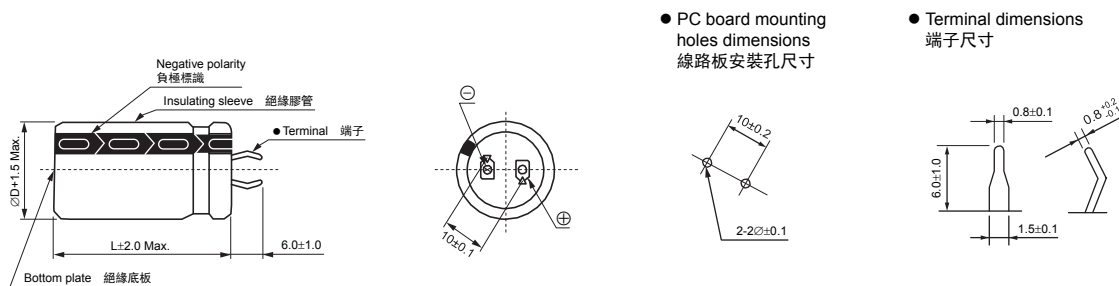

□ FREQUENCY COEFFICIENT OF ALLOWABLE RIPPLE CURRENT 紋波電流頻率補償系數

Frequency 頻率	50Hz	120Hz	300Hz	1KHz	10KHz	
Coefficient 系數	~ 100µF	0.88	1.00	1.06	1.15	1.20
	160 ~ 250µF	0.85	1.00	1.20	1.25	1.45
	315µF	0.88	1.00	1.15	1.20	1.40

The endurance of capacitors is reduced with internal heating produced by ripple current at the rate of halving the lifetime with every 5~10°C rise. When long life performance is required in actual use, the rms ripple current has to be reduced. 鋁電解電容器在疊加紋波電流後會引起發熱, 溫度每上升 5~10°C 壽命會減半。若要保持長壽命性能, 請在使用過程中適當降低紋波電流。

Note: All design and specifications are for reference only and is subject to change without prior notice. If any doubt about safety for your application, please contact us immediately for technical assistance before purchase.
注: 以上所提供的設計及特性參數僅供參考, 任何修改不作預先通知。如果在使用上有疑問, 請在採購前與我們聯繫, 以便提供技術上的協助。

CAT.2023/V2

ST Series

□ DIMENSIONS & MAXIMUM PERMISSIBLE RIPPLE CURRENT & IMPEDANCE 規格尺寸及最大允許紋波電流及阻抗值

WV		16 (1C)			25 (1E)			35 (1V)		
Parameter 參數 μF	Parameter 參數	Case size ØDxL (mm) 尺寸	Impedance (Ω) max. 20°C, 100KHz 阻抗值	Ripple current 紋波電流 (A rms, 105°C, 100KHz)	Case size ØDxL (mm) 尺寸	Impedance (Ω) max. 20°C, 100KHz 阻抗值	Ripple current 紋波電流 (A rms, 105°C, 100KHz)	Case size ØDxL (mm) 尺寸	Impedance (Ω) max. 20°C, 100KHz 阻抗值	Ripple current 紋波電流 (A rms, 105°C, 100KHz)
		2200	222							22 x 25
3300	332				22 x 25	0.181	1.25	22 x 30 (25 x 30)	0.161 (0.161)	1.51 (1.92)
4700	472	22 x 25	0.141	1.30	22 x 30 (25 x 25)	0.127 (0.127)	1.61 (1.61)	22 x 35 (25 x 40) (30 x 25)	0.113 (0.113) (0.113)	1.92 (2.31) (1.92)
6800	682	22 x 35 (25 x 30)	0.098 (0.098)	1.80 (1.80)	22 x 35 (25 x 30)	0.088 (0.088)	1.91 (1.91)	22 x 45 (25 x 45) (30 x 30)	0.078 (0.078) (0.078)	2.31 (2.87) (2.33)
10000	103	22 x 45 (25 x 35) (30 x 25)	0.066 (0.066) (0.066)	2.34 (2.25) (2.19)	22 x 45 (25 x 40) (30 x 30)	0.060 (0.060) (0.060)	2.51 (2.42) (2.42)	30 x 35 (35 x 30)	0.053 (0.053)	2.87 (2.87)
15000	153	25 x 45 (30 x 35) (35 x 30)	0.044 (0.044) (0.044)	2.82 (2.82) (2.82)	25 x 45 (30 x 35) (35 x 30)	0.040 (0.040) (0.040)	3.11 (3.11) (3.11)	30 x 45 (35 x 40)	0.035 (0.035)	3.66 (3.66)
22000	223	30 x 45 (35 x 35)	0.030 (0.030)	3.13 (3.09)	30 x 45 (35 x 40)	0.027 (0.027)	3.85 (3.85)	35 x 45	0.024	4.53

WV		50 (1H)			63 (1J)			80 (1K)		
Parameter 參數 μF	Parameter 參數	Case size ØDxL (mm) 尺寸	Impedance (Ω) max. 20°C, 100KHz 阻抗值	Ripple current 紋波電流 (A rms, 105°C, 100KHz)	Case size ØDxL (mm) 尺寸	Impedance (Ω) max. 20°C, 100KHz 阻抗值	Ripple current 紋波電流 (A rms, 105°C, 100KHz)	Case size ØDxL (mm) 尺寸	Impedance (Ω) max. 20°C, 100KHz 阻抗值	Ripple current 紋波電流 (A rms, 105°C, 100KHz)
		1000	102				22 x 25	0.398	0.90	22 x 25
1200	122				22 x 25	0.332	1.05	22 x 30 (25 x 25)	0.276 (0.276)	1.24 (1.24)
1500	152	22 x 25	0.310	1.22	22 x 25	0.265	1.28	22 x 35 (25 x 30)	0.221 (0.221)	1.54 (1.54)
2200	222	22 x 30 (25 x 25)	0.211 (0.211)	1.59 (1.59)	22 x 35 (25 x 25)	0.181 (0.181)	1.78 (1.60)	22 x 45 (25 x 35) (30 x 30)	0.151 (0.151) (0.151)	1.95 (1.94) (2.05)
2700	272				22 x 35 (25 x 30)	0.147 (0.147)	1.81 (1.81)			
3300	332	22 x 35 (25 x 30)	0.141 (0.141)	1.93 (1.88)	22 x 40 (25 x 35) (30 x 25) (35 x 25)	0.121 (0.121) (0.121) (0.121)	2.00 (2.03) (1.81) (2.03)	25 x 50 (30 x 35) (35 x 30)	0.101 (0.101) (0.101)	2.25 (2.24) (2.30)
3900	392				20 x 50 (22 x 50) (25 x 40) (30 x 30) (35 x 25)	0.102 (0.102) (0.102) (0.102) (0.102)	2.16 (2.37) (2.22) (2.19) (2.24)			
4700	472	22 x 45 (25 x 35) (30 x 30) (35 x 25)	0.099 (0.099) (0.099) (0.099)	2.43 (2.34) (2.42) (2.42)	25 x 45 (30 x 35) (35 x 25)	0.085 (0.085) (0.085)	2.56 (2.66) (2.46)	30 x 45 (35 x 35)	0.071 (0.071)	2.84 (2.80)
5600	562				25 x 50 (30 x 35) (35 x 30)	0.071 (0.071) (0.071)	2.93 (2.79) (2.88)			
6800	682	25 x 45 (30 x 35) (35 x 30)	0.068 (0.068) (0.068)	3.10 (3.10) (3.10)	30 x 40 (35 x 35) (35 x 40)	0.059 (0.059) (0.059)	3.25 (3.26) (3.49)			
8200	822	30 x 45 (35 x 40)	0.046 (0.046)	4.18 (4.20)	35 x 40	0.049	3.52			

WV		100 (2A)			160 (2C)			200 (2D)		
Parameter 參數 μF	Parameter 參數	Case size ØDxL (mm) 尺寸	Impedance (Ω) max. 20°C, 100KHz 阻抗值	Ripple current 紋波電流 (A rms, 105°C, 100KHz)	Case size ØDxL (mm) 尺寸	Impedance (Ω) max. 20°C, 100KHz 阻抗值	Ripple current 紋波電流 (A rms, 105°C, 100KHz)	Case size ØDxL (mm) 尺寸	Impedance (Ω) max. 20°C, 100KHz 阻抗值	Ripple current 紋波電流 (A rms, 105°C, 100KHz)
		220	221				22 x 25	0.603	0.73	22 x 25
270	271				22 x 25	0.491	0.81	22 x 25	0.491	1.03
330	331				22 x 25 (25 x 25)	0.402 (0.402)	0.98 (0.94)	22 x 30	0.402	1.21
390	391				22 x 25 (25 x 25)	0.340 (0.340)	1.03 (1.09)	22 x 35 (25 x 25)	0.340 (0.340)	1.39 (1.31)
470	471				22 x 30 (25 x 25)	0.282 (0.282)	1.21 (1.19)	22 x 35 (25 x 30)	0.282 (0.282)	1.52 (1.52)
560	561				22 x 35 (25 x 30) (30 x 25)	0.237 (0.237) (0.237)	1.40 (1.40) (1.40)	22 x 40 (25 x 35) (30 x 25)	0.237 (0.237) (0.237)	1.66 (1.75) (1.64)
680	681				22 x 40 (25 x 35)	0.195 (0.195)	1.62 (1.61)	22 x 45 (25 x 40)	0.195 (0.195)	2.04 (2.04)

Note: All design and specifications are for reference only and is subject to change without prior notice. If any doubt about safety for your application, please contact us immediately for technical assistance before purchase.

注：以上所提供的設計及特性參數僅供參考，任何修改不作預先通知。如果在使用上有疑問，請在採購前與我們聯繫，以便提供技術上的協助。

CAT.2023/V2

ST Series

□ DIMENSIONS & MAXIMUM PERMISSIBLE RIPPLE CURRENT & IMPEDANCE 規格尺寸及最大允許紋波電流及阻抗值

WV		100 (2A)			160 (2C)			200 (2D)		
Parameter 參數 μF	Parameter 參數	Case size ∅D×L (mm) 尺寸	Impedance (Ω) max. 20°C, 100KHz 阻抗值	Ripple current 紋波電流 (A rms, 105°C, 100KHz)	Case size ∅D×L (mm) 尺寸	Impedance (Ω) max. 20°C, 100KHz 阻抗值	Ripple current 紋波電流 (A rms, 105°C, 100KHz)	Case size ∅D×L (mm) 尺寸	Impedance (Ω) max. 20°C, 100KHz 阻抗值	Ripple current 紋波電流 (A rms, 105°C, 100KHz)
		820	82				22 x 45 (25 x 40) (30 x 30)	0.162 (0.162) (0.162)	1.86 (1.86) (1.79)	25 x 45 (30 x 35)
1000	102	22 x 30 (25 x 25)	0.265 (0.265)	1.36 (1.36)	22 x 50 (25 x 45) (30 x 35)	0.133 (0.133) (0.133)	2.81 (2.15) (2.09)	25 x 50 (30 x 40) (35 x 30)	0.133 (0.133) (0.199)	2.26 (2.63) (2.51)
1200	122	22 x 35 (25 x 30)	0.221 (0.221)	1.48 (1.49)	25 x 50 (30 x 40) (35 x 30)	0.111 (0.111) (0.166)	2.35 (2.35) (2.29)	30 x 45 (35 x 35)	0.111 (0.166)	3.00 (2.92)
1500	152	22 x 40 (25 x 35) (30 x 25)	0.177 (0.177) (0.177)	1.82 (1.85) (1.80)	30 x 35 (35 x 35)	0.088 (0.133)	2.56 (2.72)	30 x 50 (35 x 40)	0.088 (0.133)	3.36 (3.34)
1800	182				30 x 45 (35 x 40)	0.074 (0.111)	2.97 (3.09)	30 x 60 (35 x 45)	0.074 (0.111)	3.64 (3.51)
2200	222	25 x 45 (30 x 35) (35 x 30)	0.121 (0.121) (0.121)	2.50 (2.50) (2.50)	30 x 60 (35 x 50)	0.060 (0.090)	3.48 (3.51)	35 x 55	0.090	4.01
2700	272	25 x 50 (30 x 40) (35 x 35)	0.098 (0.098) (0.098)	2.70 (2.72) (2.82)	35 x 55	0.074	4.05			
3300	102	30 x 45 (35 x 35)	0.080 (0.080)	3.11 (3.07)						
3900	122	30 x 50 (35 x 40)	0.068 (0.068)	3.40 (3.38)						
4700	152	35 x 45	0.056	3.90						

WV		250 (2E)			350 (2V)			400 (2G)		
Parameter 參數 μF	Parameter 參數	Case size ∅D×L (mm) 尺寸	Impedance (Ω) max. 20°C, 100KHz 阻抗值	Ripple current 紋波電流 (A rms, 105°C, 100KHz)	Case size ∅D×L (mm) 尺寸	Impedance (Ω) max. 20°C, 100KHz 阻抗值	Ripple current 紋波電流 (A rms, 105°C, 100KHz)	Case size ∅D×L (mm) 尺寸	Impedance (Ω) max. 20°C, 100KHz 阻抗值	Ripple current 紋波電流 (A rms, 105°C, 100KHz)
		68	680							22 x 25
82	820							22 x 30	2.427	0.54
100	101				22 x 25	1.990	0.52	22 x 30	1.990	0.67
120	121				22 x 30 (25 x 25)	1.659 (1.659)	0.62 (0.65)	22 x 35 (25 x 25)	1.659 (1.659)	0.78 (0.69)
150	151				22 x 35	0.885	0.74	22 x 40 (25 x 30)	1.327 (1.327)	0.91 (0.83)
180	181	22x 25	0.737	0.77	22 x 40 (25 x 30)	1.106 (1.106)	0.81 (0.77)	22 x 45 (25 x 35)	1.106 (1.106)	1.04 (0.97)
220	221	22 x 30	0.603	0.87	22 x 45 (25 x 35)	0.905 (0.905)	0.94 (0.91)	22 x 50 (25 x 40) (30 x 30)	0.905 (0.905) (0.905)	1.17 (1.14) (1.12)
270	271	22 x 30 (25 x 25)	0.491 (0.491)	1.02 (1.08)	22 x 50 (25 x 40) (30 x 30)	0.491 (0.491) (0.491)	1.09 (1.06) (1.05)	25 x 50 (30 x 35) (35 x 30)	0.737 (0.737)	1.40 (1.39) (1.31)
330	331	22 x 35 (25 x 30)	0.402 (0.402)	1.20 (1.27)	25 x 45 (30 x 35) (35 x 30)	0.402 (0.402) (0.603)	1.24 (1.24) (1.33)	30 x 40 (35 x 30)	0.603 (0.603)	1.31 (1.27)
390	391	22 x 40 (25 x 35) (30 x 25)	0.340 (0.340) (0.340)	1.38 (1.46) (1.39)	30 x 40 (35 x 30)	0.340 (0.510)	1.42 (1.39)	30 x 45 (35 x 35)	0.510 (0.510)	1.49 (1.47)
470	471	22 x 45 (25 x 40) (30 x 30)	0.282 (0.282) (0.282)	1.46 (1.69) (1.63)	30 x 45 (35 x 35)	0.282 (0.423)	1.56 (1.53)	30 x 50 (35 x 40)	0.423 (0.423)	1.72 (1.71)
560	561	25 x 45	0.237	1.93	30 x 50 (35 x 40)	0.237 (0.355)	1.77	30 x 60 (35 x 45)	0.355 (0.355)	2.03 (2.23)
680	681	25 x 50 (30 x 35) (35 x 30)	0.195 (0.195) (0.293)	2.04 (2.06) (2.06)	30 x 60 (35 x 50)	0.195 (0.293)	1.94	35 x 55	0.293	2.31
820	821	30 x 45 (35 x 35)	0.162 (0.243)	2.48 (2.41)	35 x 55	0.243	2.23	35 x 60	0.243	2.54
1000	102	30 x 50 (35 x 40)	0.133 (0.199)	2.65 (2.76)						
1200	122	30 x 50 (35 x 40)	0.111 (0.166)	3.14 (3.14)						
1500	152	30 x 60 (35 x 45)	0.102 (0.135)	3.36 (3.34)						
1800	182	35 x 60	0.111	3.97						

Note: All design and specifications are for reference only and is subject to change without prior notice. If any doubt about safety for your application, please contact us immediately for technical assistance before purchase.

注：以上所提供的設計及特性參數僅供參考，任何修改不作預先通知。如果在使用上有疑問，請在採購前與我們聯繫，以便提供技術上的協助。

CAT.2023/V2

ST Series

□ DIMENSIONS & MAXIMUM PERMISSIBLE RIPPLE CURRENT & IMPEDANCE 規格尺寸及最大允許紋波電流及阻抗值

WV		450 (2W)		
μF	Parameter 參數	Case size ∅DxL (mm) 尺寸	Impedance (Ω) max. 20°C, 100KHz 阻抗值	Ripple current 紋波電流 (A rms, 105°C, 100KHz)
	82	820	22 x 30 (25 x 25)	2.427 (2.427)
100	101	22 x 35	1.990	0.67
120	121	22 x 40 (25 x 30) (30 x 25)	1.659 (1.659) (1.659)	0.78 (0.74) (0.77)
150	151	22 x 45 (25 x 35) (30 x 30) (35 x 25)	1.327 (1.327) (1.327) (1.327)	0.92 (0.89) (0.93) (0.95)
180	181	22 x 50 (25 x 40) (30 x 30) (35 x 25)	1.106 (1.106) (1.106) (1.106)	1.06 (1.03) (1.01) (1.04)
220	221	25 x 45 (30 x 35) (35 x 30)	0.905 (0.905) (0.905)	1.18 (1.18) (1.22)
270	271	30 x 40	0.737	1.17
330	331	30 x 50 (35 x 35)	0.603 (0.603)	1.42 (1.64)
390	391	35 x 40	0.510	1.54
470	471	35 x 50	0.423	1.85
560	561	35 x 50	0.355	2.02

- Please refer to page 20 "Packaging Specifications" for the minimum package quantity. 最小包裝數量請查閱第 20 頁“包裝標準”。
- Please refer to page 16 for the Part Number System. 產品編碼規則請查閱第 16 頁。

Note: All design and specifications are for reference only and is subject to change without prior notice. If any doubt about safety for your application, please contact us immediately for technical assistance before purchase.

注：以上所提供的設計及特性參數僅供參考，任何修改不作預先通知。如果在使用上有疑問，請在採購前與我們聯繫，以便提供技術上的協助。

CAT.2023/V2

