

TIGER EYE™ FLAT IDC WIRE CABLES

(1.27 mm) .050" PITCH • FFSD SERIES

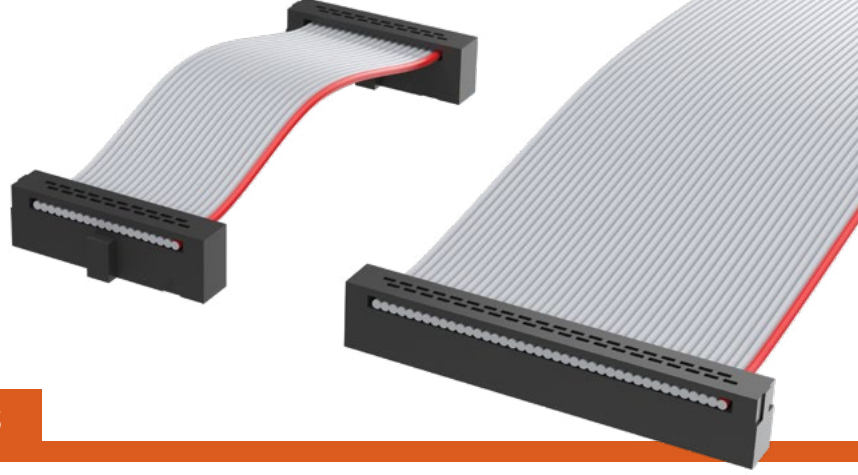

FFSD

Mates:

FTS, FTSH, EHF,
SHF, ESHF

SPECIFICATIONS

Insulator Material:

PBT

Contact:

BeCu

Plating:

10 μ" (0.25 μm) Au over 50 μ"
(1.27 μm) Ni on contact area;
Sn over 50 μ" (1.27 μm) Ni
on balance

Wire:

30 AWG

Current Rating (FFSD/FTSH):

2.3 A per pin
(2 pins powered)

Operating Temp Range:

-40 °C to +105 °C

Lead Size Accepted:

(0.41 mm) .016" SQ

Insertion Depth:

(2.64 mm) .104" to
(3.17 mm) .125"

ALSO AVAILABLE

Other Sizes
(MOQ Required)

SERIES	NO. PINS PER ROW	END OPTION	OVERALL LENGTH	01	N	OTHER OPTION
--------	------------------	------------	----------------	----	---	--------------

FFSD
= Socket Strip

-04, -05, -06, -08, -10, -11, -12, -13, -15, -17, -20, -25
(Standard sizes)

-S
= Single End
-D
= Double End

-"XX.XX"
= Assembled Length

-N
= Notch Polarization (Notch option not available with -04 position)

-RW
= Reverse Wiring (Red wire opposite position #1)

-D "XX"
= Daisy Chain

-SR
= Strain Relief (Mates only with ESHF Series) (Not available with -O, -M, -R or -DXX)

-R
= Reverse

-M
= Middle Reverse (Requires -DXX)

-O
= Outside Reverse (Requires -DXX)

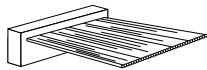
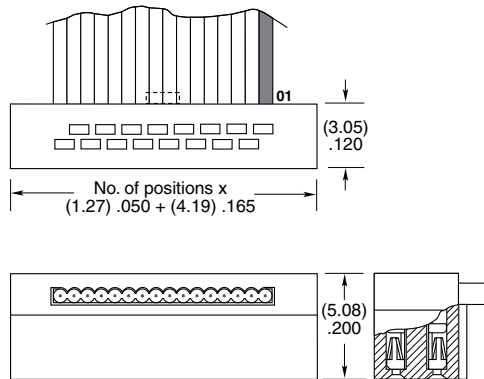

Single End (-S)

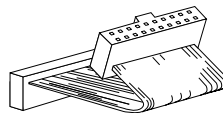

Double End (-D)

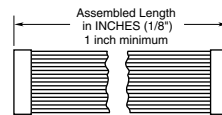

Assembled Length (-"XX.XX")

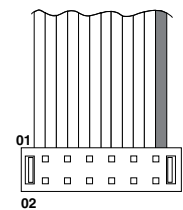

Reverse Wiring (-RW)

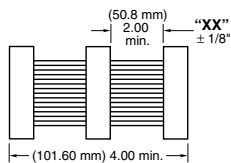

Daisy Chain (-D "XX")

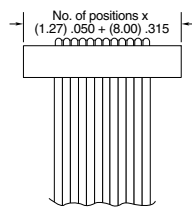

Strain Relief (-SR)

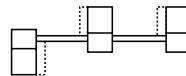

Reverse (-R)

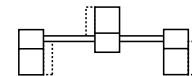

Middle Reverse (-M)

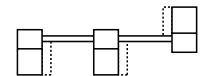

Outside Reverse (-O)

Note:
This Series is non-standard,
non-returnable.