

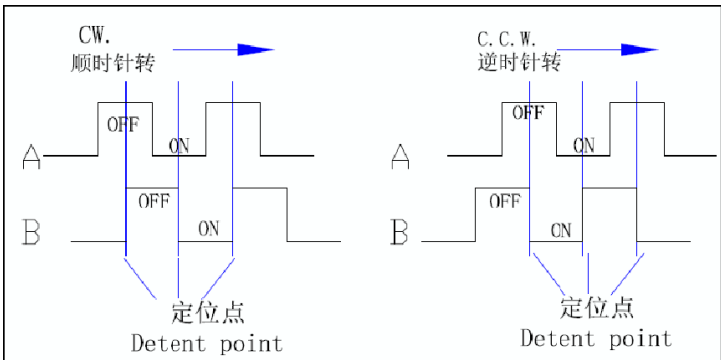

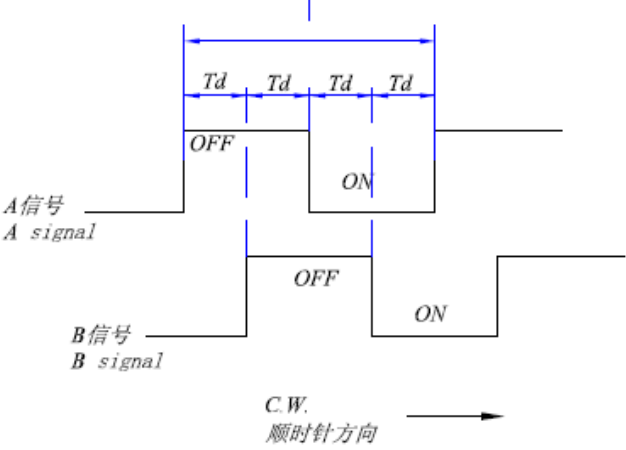

编码器规格书

ENCODER SPECIFICATIONS

1 一般事项 General information	
1-1 适用型号 Applicable models	ED089、ED09D 系列 ED089 & ED09D Serial
1-2 使用环境温度 Usage environment temperature	- 30℃ ~ + 70℃
1-3 保存环境温度 Storage environment temperature	- 40℃ ~ + 70℃
1-4 测试条件 Test condition	温度: 5~35℃, 湿度: 45~85%HR Temperature: 5~35℃, Moisture: 45~85%HR
1-5 环保要求 Environmental requisition	本产品符合 RoHS 指令 This product is compliant with RoHS Directive
1-6 耐焊接热 Soldering heat-resistance	1、手工焊接温度最高 350℃ ± 5℃, 3 秒; 2、自动焊接温度最高 260℃ ± 5℃, 3 秒; 基板表面预热温度最高 100℃, 1 分钟以内; 3、以上过程均保证在 1 到 2 次; 4、不适用回流焊。 1. Soldering iron Max ,350℃ ± 5℃ at 3 sec 2. Auto soldering 260℃ ± 5℃ max. at 3 Sec. Preheating temperature of board surface: 100℃ max. at within 1 minutes. 3. To guarantee the above process at 1 or 2 times. 4. No apply the reflow soldering.
1-7 原产地 Country of origin	中国 China
2 构造 Construction	
2-1 外观 Appearance	各部件应完整, 无锈蚀、裂痕、电镀不良 Every part should finished, be not exist rust flaw crack and bad plating
2-2 寸法 Measurements	依照图面规定 Under conditions prescribed by design drawing.
3 机械性能 Mechanical characteristics	
3-1 全回转角度 Total rotational angle	360°
3-2 回转力矩 Rotational torque	150~450gf.cm (旋转速度: 60° /1 秒) 150~450gf.cm (Rotational velocity : 60° /1 Sec.)
3-3 定位数 Number of detent	20 个定位 20 Detents
3-4 切换角度 Change-Over angle	18° ± 3°
3-5 轴压引强度 Pull-Push Strength of Shaft	10Kgf.cm Min.
3-6 螺母锁紧强度 Nut tightening strength	10Kgf.cm Min.
3-7 轴摇晃度 Shaft wobble	在单个轴顶端施加压力 250gf, 轴径向偏移量小于: 1*轴长 L 尺寸/30mm On the tip of the single shaft exert pressure 250gf , Shaft radial deviant be smaller than: 1*shaft long L size/30mm
4 电气性能 Electrical characteristics	
4-1 额定电压 Voltage rating	DC 5V
4-2 额定电流 Current rating	1mA

4-3 耐电压 Voltage proof	AC 300V 1 分钟以上 (端子和本体之间, 端子和轴芯之间) 1 Minute at AC 300V (Between terminal – case, Between terminal –shaft).
4-4 最高使用电压 Maximum operating voltage	DC 10V 或 AC50V DC 10V or AC50V
4-5 最大使用电流 Maximum operating current	2.5mA
4-6 接触抵抗 Ratings power	10 Ω Max
4-7 绝缘抵抗 Insulation resistance	DC 250V 100MΩ 以上 (端子和本体之间, 端子和轴芯之间) 100MΩ min. At DC 250V (Between terminal – case, Between terminal –shaft).
4-8 脉冲数 Number of pulses	旋转一周 (360°) 输出 20 个脉冲 Output 20 pulses of rotate one circle(360°).
4-9 输出信号 Output signal	<p>A、B 信号, 相位差的输出如下: * 备注: A 信号 (A-COM 间), B 信号 (B-COM 间) Output of phase difference, signals A and B, is as follows. *Remark: A signal (Between A-common) ,B signal (Between B-common)</p> 
4-10 相位差 Phase difference	<p>在没有定位的情况下 $T_d = T/4 \pm T/6$ * 备注: T=周期 In no detent circumstances $T_d = T/4 \pm T/6$ in case of no detent. *Remark: T= Cycle</p> 
4-11 回转寿命 Rotational life	<p>无负荷情况下每小时旋转 600 周, 寿命 30,000 周, 寿命后: 1、绝缘抵抗 10MΩ 以上 DC250V (端子和本体之间, 端子和轴芯之间); 2、耐电压 AC100V 1 分钟 (端子和本体之间, 端子和轴芯之间), 绝缘阻抗无击穿; 3、回转力矩: 满足第 3-2 项; 4、外观和结构无损坏。 30,000 cycles under no load circumstances by 600 r/h of rotation, afterlife cycle: 1. Insulation resistance:10MΩ min. At DC 250V. (Between terminal – case, Between terminal –shaft). 2. Withstanding voltage : AC 100V at 1 minute (Between terminal – case, Between terminal –shaft). No subversion on insulation resistance. 3. Rotational torque : Content item No. 3-2. 4. No damage on appearance and structure.</p>

5 开关性能 Switch characteristics				
<input type="checkbox"/> 适用 <input checked="" type="checkbox"/> 不适用 Apply No apply				
5-1 开关型式 Switch type	按压式 Push type			
5-2 开关回路、 Switch configuration, Contact point	单刀单掷 S. P. S. T			
5-3 开关定格电力 Switch working angle	DC 16, 0.5A			
5-4 开关按压行程 Switch push travel	0.5+0.1/-0.2mm			
5-5 开关按压力 Switch push pressure	700±300gf			
5-6 开关接触电阻 Switch contact resistance	≤100mΩ, 寿命后≤500mΩ ≤100mΩ, afterlife cycle: ≤500mΩ			
5-7 开关按压寿命 Operating life for momentary push switch	无负荷情况下每小时按压 600 次，寿命 20,000 次，寿命后： 1、耐电压 AC100V 1 分钟（开关端子和本体之间），绝缘阻抗无击穿； 2、开关按压力：满足第 5-5 项； 3、外观和结构无损坏。 20,000 cycles under no load circumstances by 600 r/h of push, afterlife cycle: 1. Withstanding voltage: AC 100V at 1 minute (Between switch terminal – case). No subversion on insulation resistance. 2. Switch push pressure: Content item No. 5-5. 3. No damage on appearance and structure.			
6 防水性能 Waterproof standard characteristics				
6-1 防水标准 Waterproof standard	<input type="checkbox"/> 不适用 No Apply <input checked="" type="checkbox"/> 七级防水 编码器轴芯轴套置于水中 1 米深处，其它部件密封后暴露在标准大气压中，30 分钟后电位器内部未进水。 Grade -7 of Waterproof standard Encoder's Shaft and Bush in water 1M deep, after other component sealed exposed to the standard atmosphere, after 30 minutes no water into the Encoder's inner.			
东莞市长泰尔电子有限公司 DONG GUAN CHANG TAI ER ELECTRONIC CO., LTD.		制作 Designed By	审核 Checked By	核准 Approved By
				

16 15 14 13 12 11 10 9 8 7 6 5 4 3 2 1

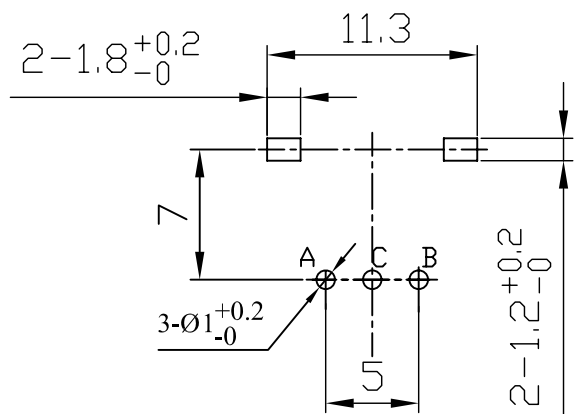
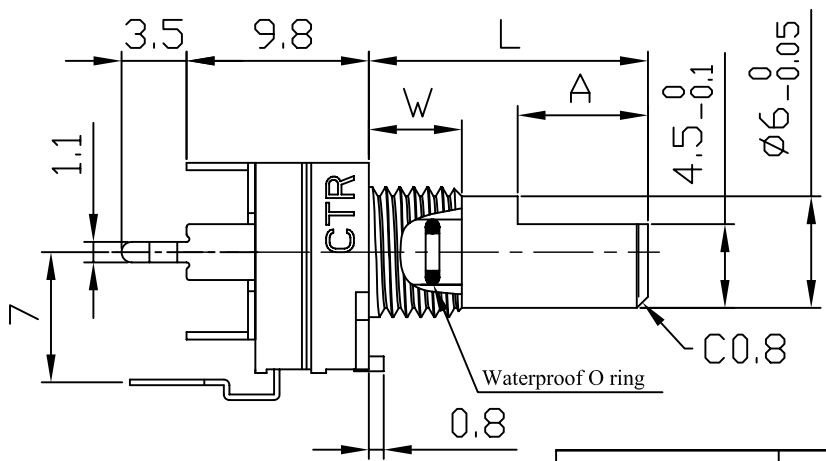
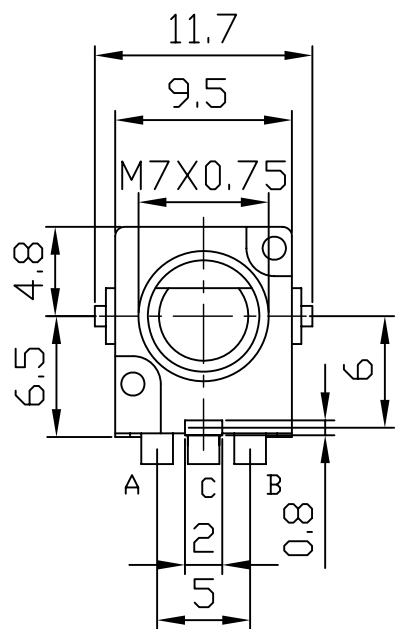

型号	W
ED09D12O	5
ED09D22O	7
ED09D32O	10

Washer 垫圈(可选件) Nut 螺母(可选件)

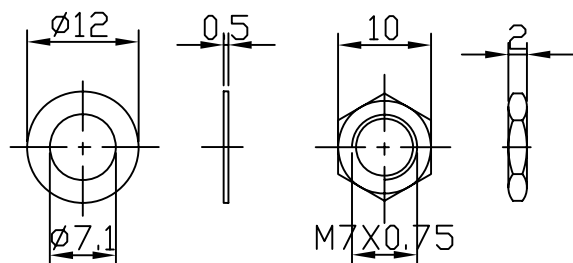

轴的类型:

FB Shaft Style

FC Shaft Style

FD Shaft Style

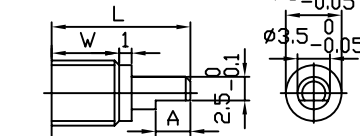
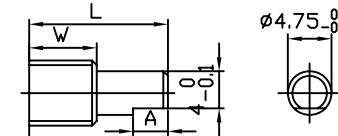
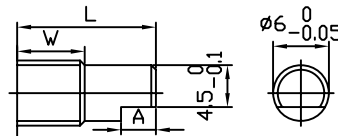

L	15	16.5	17	18	18	20	20	20	
A	7	5.5	8	5.4	9	5.4	9.0	12	

L	15	16.5	17	18	18	20	20	20	
A	7	5.5	8	5.4	9	5.4	9.0	12	

L	15	16.5	17	18	18	20	20	20	
A	7	5.5	8	5.4	9	5.4	9.0	12	

KQ Shaft Style

SB Shaft Style

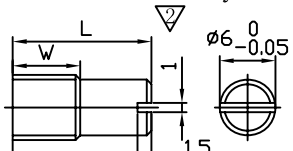
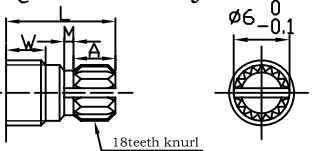

L	15	16.5	17	18	18	20	20	20	
A	7	5.5	8	5.4	9	5.4	9.0	12	
M	1	1	1	1	1	2	2	2	

L	15			
A	1.5			

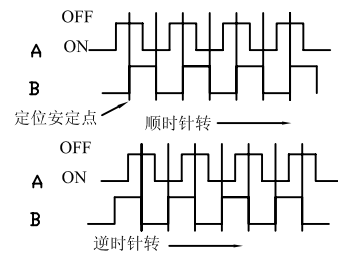

▼			
▼			
▼			
▼	增加SB轴型规格	廖金华	2013-11-06
▼			
标记	变更内容	改图	日期

未注尺寸公差		东莞市长泰尔电子有限公司					
L ≤ 1.0时 ±0.1		视角	制图	谢敏	出图日	2018-03-29	
1.0 < L ≤ 10时 ±0.3		比例	2.5:1	单位	mm		
10 < L ≤ 30时 ±0.5		版本	1.0	设计	审核	批准	
30 < L ≤ 100时 ±1.0		品名	ED09D□2O安装尺寸图		工程 2018.03.29 谢敏	工程 2018.03.29 喻钊	
		图号	ED09D□2O-□□□□-2018		工程 2018.03.29 彭先炎		

16 15 14 13 12 11 10 9 8 7 6 5 4 3 2 1