

SE03-EMC3838A-C90

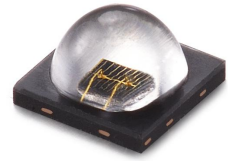

■ 特点 Features :

- 黑色 EMC 封装 Black EMC Package
- 适用于 SMT 组装 Suitable for SMT assembly
- 峰值波长 850nm Peak wavelength 850 nm
- 高效红外光源 IR lightsource with high efficiency



■ 应用 Applications :

- 监控摄像机辅助光源 Auxiliary light source for surveillance camera
- 红外数据传输 Infrared data transmission
- 红外传感器 infrared sensor

■ 外观及推荐焊盘尺寸 Appearance and Recommended pad size :

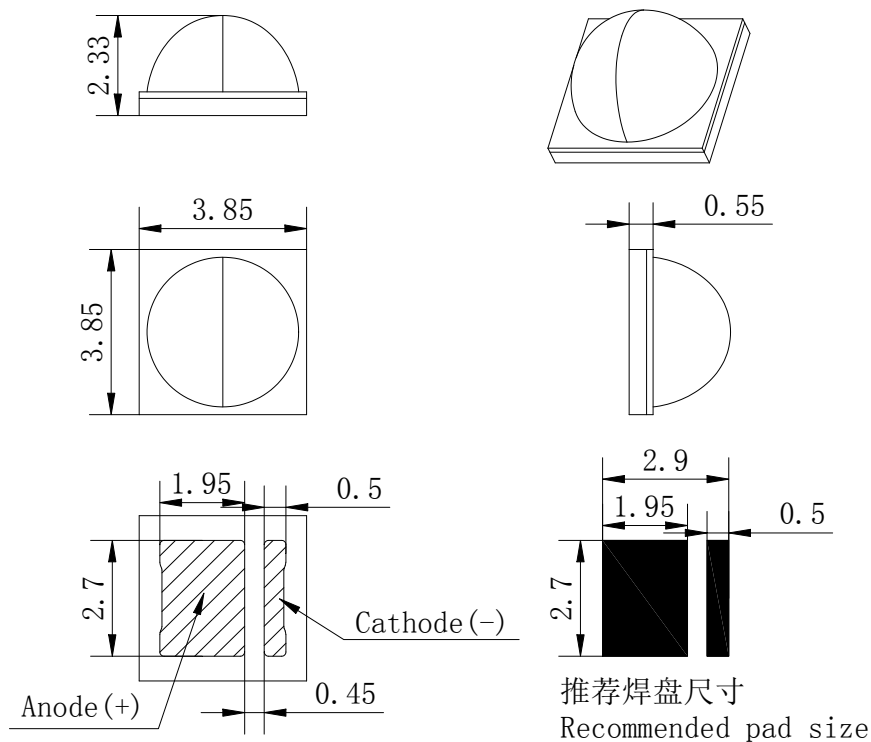

备注 note :

1. 所有标注尺寸单位为毫米
All dimensioning units are millimeters.
2. 除特别标注外, 所有尺寸允许公差 $\pm 0.15\text{mm}$ 。
Except for special markings, tolerances on all dimensions are allowed to be $\pm 0.15\text{mm}$.

■ 绝对最大额定值 Absolute maximum rating :

项目 Parameter	符号 Symbol	最大额定值 Maximum Rating	单位 Unit	环境温度 ambient temperature
功耗 Power Dissipation	Pd	1.9	W	Ta=25°C
正向电流 Forward Current	IF	≤1000	mA	Ta=25°C
反向电压 Reverse voltage	VR	5.0	V	Ta=25°C
工作温度 Operating Temperature	TOPR	-30°C~+85°C	°C	
存储温度 Storage Temperature	TSTG	-40°C~+100°C	°C	
回流焊温度 Soldering Temperature	TSOL	260°C for 5sec	°C	

■ 光电特性 Electrical-optical characteristics :

项目 Parameter	符号 Symbol	条件 Condition	最小 Min	平均 Typ	最大 Max	单位 Unit
辐射通量 Radiant flux	Po	IF=350mA	200	-	280	mW
视角 Half-value angle	2θ1/2	IF=350mA	-	90	-	Deg
光线光谱 Peak wavelength	λp	IF=350mA	840	850	870	nm
光谱线半波宽 Half-wave width	Δλ	IF=350mA	-	30	-	nm
正向电压 Forward voltage	VF	IF=350mA	-	1.5	1.8	V
反向电流 Reverse Current	Ir	VR=5.0V	-	-	10	μA

■ 电压的分档 Voltage classification :

IF=350mA	档位 Stall	最小 MIN	最大 MAX
	I	1.3V	1.4V
	II	1.4V	1.5V
	III	1.5V	1.6V
	IV	1.6V	1.7V
	V	1.7V	1.8V

备注 Note :

1. 以上所示电压测量误差±0.1V。

The above forward voltage measurement allowance tolerance is ±0.1V.

2. 以上所示辐射通量测试误差±10%

Tolerance of measurement of total radiant flux:±10%.

3. 以上所示波长测量误差±1nm。

Tolerance of measurement of wavelength:±1nm.

4. $\theta_{1/2}$ 是半值角，指发光强度值为轴向强度值一半的方向与发光轴向（法向）的夹角。

$\theta_{1/2}$ is the half angle, which refers to the angle of the luminous intensity value in the direction of half of the axial intensity and the axial (normal) direction of the light emitting.

■ 光学特性曲线 Optical property curve :

配光曲线 Light distribution curve

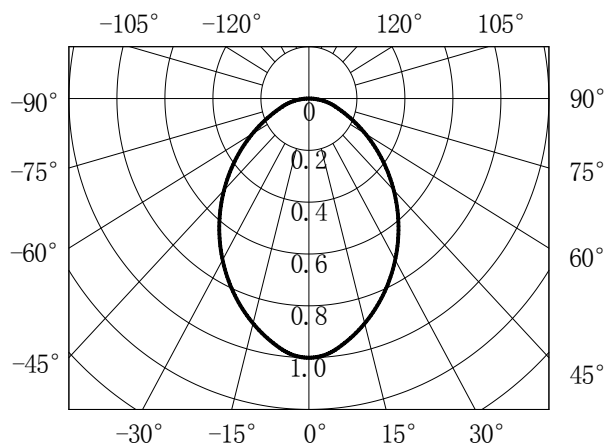
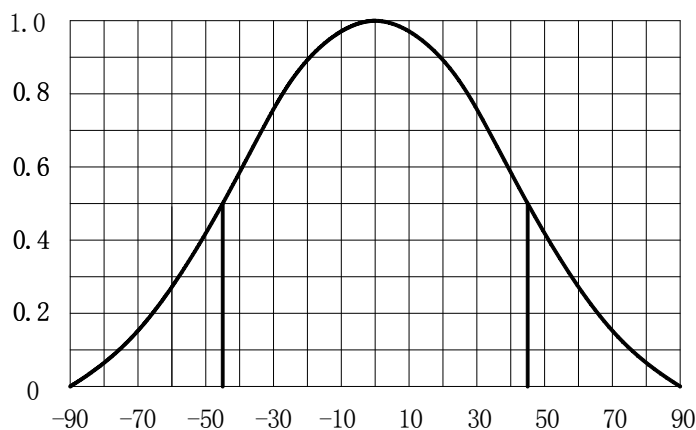

■ 光电特性曲线 Photoelectric characteristic curve :

Fig.1-Relative Radiant Flus vs. Forward Current

相对辐射通量 & 正向电流

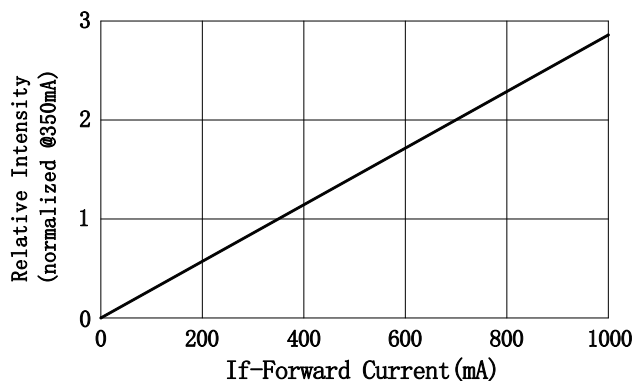

Fig.3-Relative Intensity (@350mA) vs. Ambient Temperature

辐射强度 & 环境温度

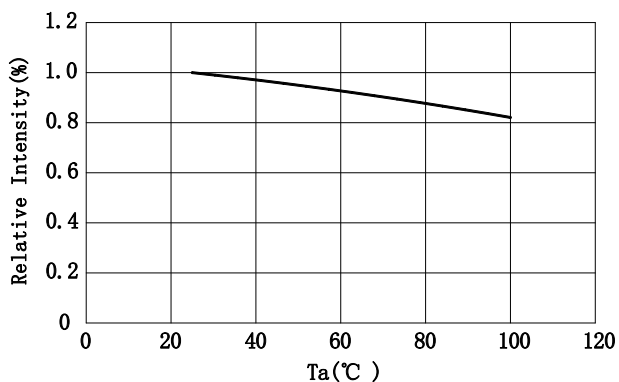

Fig.5- Peak Wavelength (@350mA) vs. Ambient Temperature.

峰值波长 & 环境温度

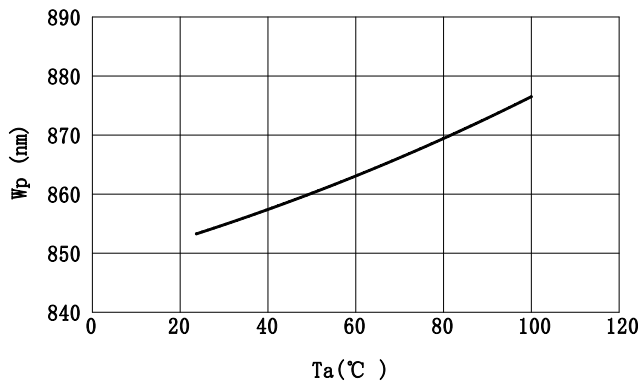

Fig.2-Forward Current vs. Forward Voltage

正向电流 & 正向电压

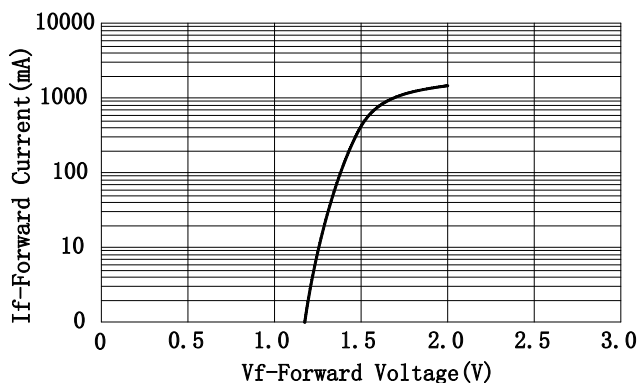

Fig.4-Forward Voltage (@350mA) vs. Temperature

正向电压 & 环境温度

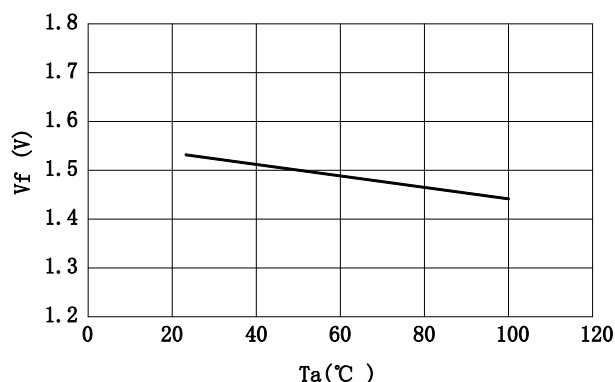
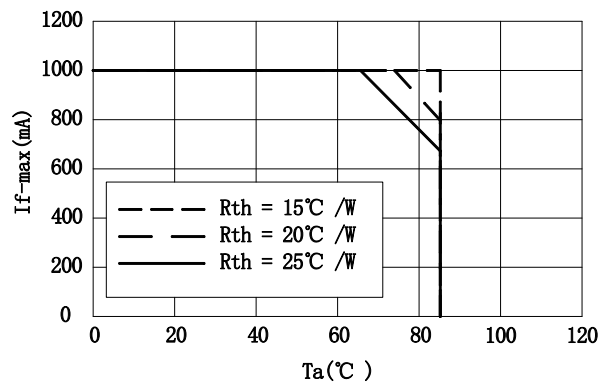

Fig.6- Maximum Driving Forward DC Current vs. Ambient Temperature (Derating based on Tj max=115°C)

最大正向直流电流 & 环境温度



■ 信赖性测试项目及条件 Reliability testing items and conditions :

测试项目 Test item	参考标准 Reference standard	测试条件 Test condition	时间 Time	数量 Number	接受/拒收 Accept / Reject
回流焊 Reflow soldering	JESD22-B106	Temp:260°C max T=5sec	3 times	22Pcs	0/1
冷热冲击 Thermal Shock	JESD22-A104	100°C±5°C 30min. ↑↓5min -40°C±5°C 30min.	100 Cycles	22Pcs	0/1
高温保存 High temperature storage	JESD22-A103	Temp:100°C±5°C	1000Hrs	22Pcs	0/1
低温保存 Low temperature storage	JESD22-A119	Temp:-40°C±5°C	1000Hrs	22Pcs	0/1
常温通电 Ambient temperature energization	JESD22-A108	Ta=25°C±5°C IF=350mA	1000Hrs	22Pcs	0/1
常温加速通电 Ambient temperature accelerated energization	JESD22-A108	Ta=25°C±5°C IF=1000mA	1000Hrs	22Pcs	0/1
高温高湿通电 High temperature and high humidity energization	JESD22-A101	85°C±5°C /85% RH IF=350mA	1000Hrs	22Pcs	0/1

■ 失效判定标准 Criteria for Judgment

项目 Item	符号 Symbol	测试条件 Test condition	判定标准 Criterion	
			最小 MIN	最大 MAX
正向电压 Forward Voltage	VF	IF=350mA	--	U.S.L*) ×1.2
反向电流 Reverse Current	Ir	VR=5V	--	U.S.L*) ×2.0
辐射通量 Radiant Flux	Φe	IF=350mA	L.S.L*) ×0.7	--

备注 Note :

1、USL : 标准值上限值, LSL : 标准值下限值

USL : Upper Standard Level, LSL: Lower Standard Level

2、数据工作表中所示的技术信息仅限于典型特征和电路实例引用的产品.它既不构成工业特性的保证,也不构成任何许可的授权。

The technical information shown in the data sheets are limited to the typical characteristics and circuit examples of the referenced products. It does not constitute the warranting of industrial property nor the granting of any license.

■ 焊接指导 Guideline for soldering :

1、使用烙铁焊接 Hand soldering

- 推荐使用功率低于 20W 的烙铁, 焊接时烙铁的温度必须保持在 300°C以下, 且每个电极只能进行一次焊接, 每次焊接的持续时间不得超过 3 秒.

A soldering iron of less than 20W is recommended to be used in Hand Soldering. Please keep the temperature of the soldering iron under 300°C while soldering. Each terminal of the LED is to go for less than 3 second and for one time only.

- 人手焊接过程中的不慎操作易引起 LED 产品的损坏, 应当小心谨慎。

Be careful because the damage of the product is often started at the time of the hand soldering.

2、回流焊接：Reflow soldering

- 推荐使用以下无铅回流焊接温度图进行

Use the conditions shown in the under Figure of Pb-Free Reflow Soldering.

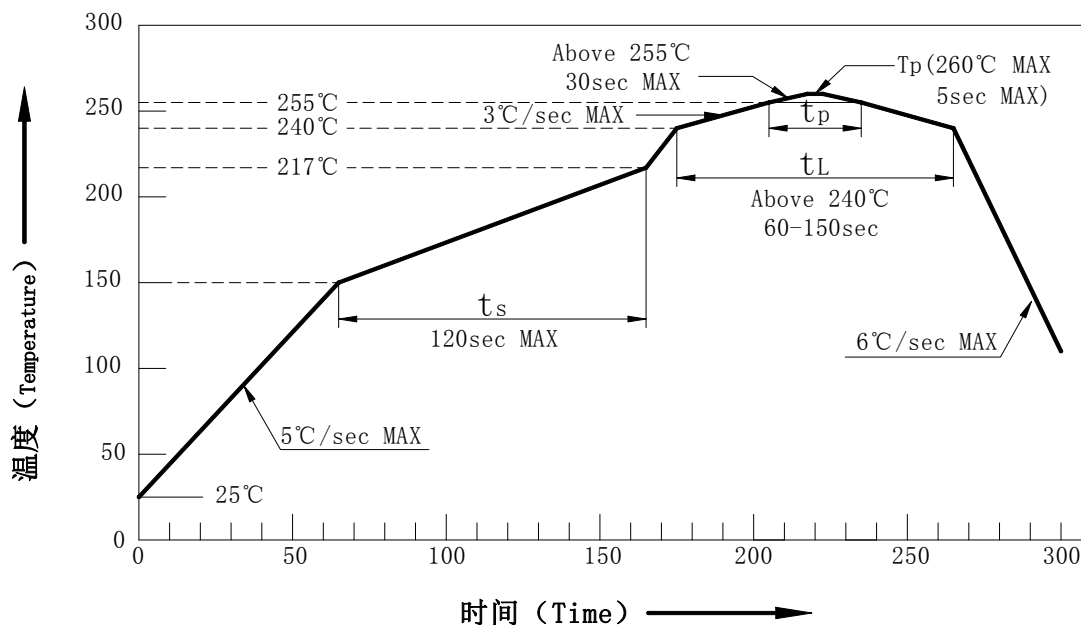

特征 Profile Feature	符号 Symbol	无铅锡膏 Pb-Free(SnAgCu)Assembly			单位 Unit
		Min	Tpy	MAX	
平均升温速度 (T _{smax} 至 T _p) Ramp-up rate to preheat (25°C to 150°C)	/		2	5	°C/s
预热：时间 (t _{smin} 至 t _{smax}) Time t _s (T _{smin} to T _{smax})	t _s	60	100	120	s
T _{smax} 升至峰值温度的速度 Ramp-up rate to peak (T _{smax} to T _p)	/		2		°C/s
限时维持高温：温度 (TL) Liquidus temperature	TL	217			°C
限时维持高温：时间 (tL) Time above liquidus temperature	tL		80	100	s
峰值温度 (T _p) Peak temperature	T _p		245	260	°C/s
与实际峰值温度 (T _p) 相差 5°C 以内的保持时间 Time within 5°C of the specified peak temperature T _p -5°C	tP	10	20	30	s
降温速度 Ramp-down rate (T _p to 100°C)	/		3	6	°C/s
降温时间 Time (25°C to T _p)	/			480	s

备注 Note :

1、回流焊最多只能进行一次。

Reflow soldering should not be done more than one times.

2、在回流焊接升温过程中，请不要对 LED 施加任何压力。

Stress on the LEDs should be avoided during heating in soldering process.

3、在焊接完成后，待产品温度下降到室温之后，再进行其他处理。

After soldering, do not deal with the product before its temperature drop down to room temperature.

3、清洗 : Cleaning

- 在焊接后推荐使用酒精进行清洗，在温度不高于 30°C 的条件下持续 3 分钟，不高于 50°C 的条件下持续 30 秒。使用其他类似溶剂清洗前，请先确认使用的溶剂不会对 LED 的封装和环氧树脂部分造成损伤。

It is recommended that alcohol be used as a solvent for cleaning after soldering. Cleaning is to go under 30°C for 3 minutes or 50°C for 30 seconds. When using other solvents, it should be confirmed beforehand whether the solvents will dissolve the package and the resin or not.

- 超声波清洗也是有效的方法，一般最大功率不应超过 300W，否则可能对 LED 造成损伤。请根据具体的情况预先测试清洗条件是否会对 LED 造成损伤。

Ultrasonic cleaning is also an effective way for cleaning. But the influence of Ultrasonic cleaning on LED depends on factors such as ultrasonic power. Generally, the ultrasonic power should not be higher than 300W. Before cleaning, a pre-test should be done to confirm whether any damage to LEDs will occur.

❖ 注意 : Note

此一般指导原则并不适用于所有 PCB 设计和焊接设备的配置。具体工艺受到诸多因素的影响，请根据特定的 PCB 设计和焊接设备来确定焊接方案

This general guideline may not apply to all PCB designs and configurations of all soldering equipment. The technique in practice is influenced by many factors it should be specialized base on the PCB designs and configurations of the soldering equipment.

■ 使用注意事项 Using Guide

1、存储 Storage

- 本产使用密封防潮抗静电袋包装,并附有干燥剂,未开封的产品保存时间 6 个月。

Moisture proof and anti-electrostatic package with moisture absorbent material is used, Packaged products have six months to save time.

- 开封前,产品须存放在温度不高于 30°C,湿度不高于 60%RH 的环境中。

Before opening the package, the product should be kept at 30°C or less and humidity less than 60%RH.

- 密封防静电袋内的湿度卡应在打开袋子后立即查看袋内的湿度指示卡来确定,湿度显示小于或等于 10%时,使用前须进行烘烤。

Seal anti-electrostatic bag humidity card should immediately check bag humidity indicator card in the open the bag after, Humidity is less than or equal to 10%, Must be baked before use.

- 开封后,产品必须 12 小时内使用完(建议工作环境温度不高于 30°C,湿度不高于 60%),如未使用完,余料须存放在温度不高于 30°C,湿度不高于 10%的环境中。

After opening the package, the product should be soldered within 12 hours. If not, please store at 30°C or less and humidity less than 10%RH. It is recommended that the product be operated at the workshop condition of 30°C or less and humidity less than 60%RH.

- 对于尚未焊接的 LED,如果吸湿剂或包装失效,或者产品没有符合以上有效存储条件,烘烤可以起到一定的性能恢复效果.烘烤条件:75±5°C,持续时间 12H。

If the moisture absorbent material has fade away or the LEDs have exceeded the storage time, baking treatment should be performed based on the following condition : 75±5°C for 12 hours.

2、静电防护 Electrostatic protection

以下操作可降低静电破坏的可能性

The following procedures may decrease the possibility of ESD damage.

- 将产品和外界之间的摩擦减到最低以避免静电产生.

Minimize friction between the product and surroundings to avoid static buildup.

- 所有的产品设备和测试仪器必须接地.

All production machinery and test instruments must be electrically grounded.

- 操作人员必须配戴静电环.

Operators must wear anti-static bracelets.

- 进入带电设备工作区域时需穿防静电服.

Wear anti-static suit when entering work areas with conductive machinery.

- 所有操作 IC 和 ESD 敏感器件元器件的工作台必须保持低于 150V 的静电保护.

All workstations that handle IC and ESD-sensitive components must maintain an electrostatic potential of 150V or less.

3、温度保护 The safe temperature for LEDs working

LED 在高温条件下, 衰减会加速, 本身应力也会增大, 若长期处于高温环境下, 极容易出现失效. 对于高密度排列使用的情况, 建议在使用过程中灯面温度不超过 55°C, 支架温度不超过 75°C.

The high temperature will make the LED' s Luminous Intensity decreased radically, if LEDs worked in hot environment for a long time, they will be disabled easily. When LEDs are working in a closed array, we suggest that the LED' s surface temperature should be lower than 55°C and the leg' s temperature should be lower than 75°C.

4、其他事项 Others

- 直接用手拿取产品不但会污染封装树脂表面，也可能由于静电等因素导致产品性能的改变，过度的压力也可能直接影响封装内部的管芯和金线，因此请勿对产品施加过度压力，特别当产品处于高温状态下，例如在回流焊接过程中。

When handling the product, touching the encapsulant with bare hands will not only contaminate its surface, but also affect on its optical characteristics. Excessive force to the encapsulant might result in catastrophic failure of the LEDs due to die breakage or wire deformation. For this reason, please do not put excessive stress on LEDs, especially when the LEDs are heated such as during Reflow Soldering.

- LED 的环氧树脂封装部分相当脆弱，请勿用坚硬、尖锐的物体刮、擦封装树脂部分。在用镊子夹取的时候也应当小心注意。

The epoxy resin of encapsulant is fragile, so please avoid scratch or friction over the epoxy resin surface. While handling the product with tweezers, do not hold by the epoxy resin, be careful.

- 不可将模组材料堆积在一起，它可能会损坏内部电路。

Do not pile up the module material and it may damage inner circuit.

- LED 工作环境及 LED 适配的材料中硫元素及化合物成分不可超过 100PPM，不可用在 PH<7 的酸性场所。

In LED working environment and compound composition of the LED, the sulfur element not be more than 100PPM. Do not apply on acid sites that PH<7.

■ 包装规格 Packing specification :

载带尺寸 Carrier Dimension

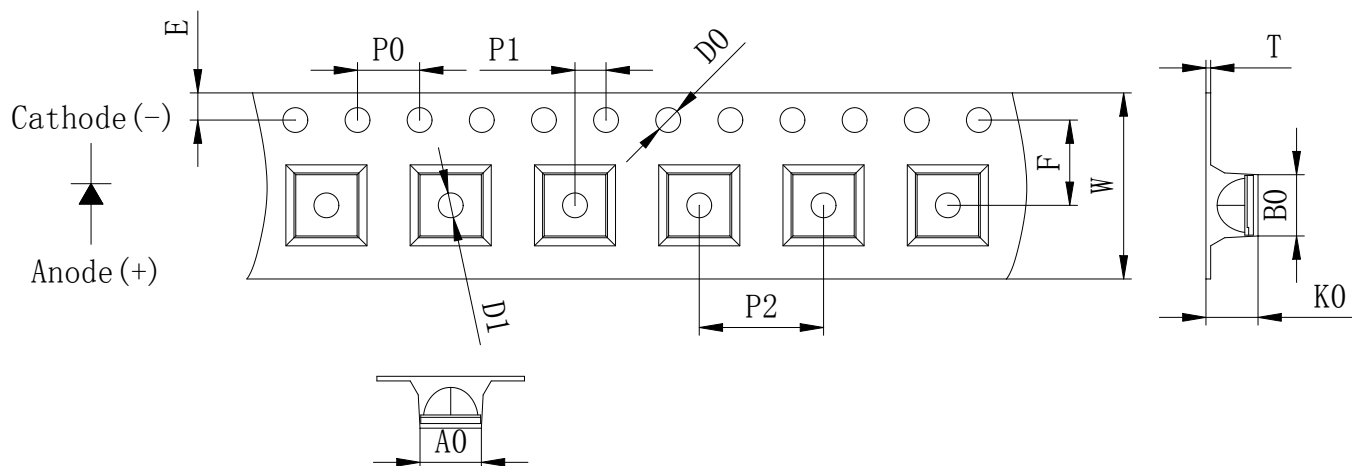

TIEM	W	A0	B0	K0	E	F	D0	D1	P0	P1	P2	T
DIM	12.00	4.00	4.00	2.50	1.75	5.50	1.50	1.60	4.00	2.00	8.00	0.30
TOLE	±0.10	±0.10	±0.10	±0.10	±0.10	±0.10	±0.10	±0.10	±0.10	±0.10	±0.10	±0.03

备注 Note :

- 任意 10 个链孔累积误差不超过 $\pm 0.2\text{mm}$;
Any 10 chain hole accumulate error not over $\pm 0.2\text{mm}$.
- 载带长度方向 100mm 距离的非平行度不超过 1mm ; 超过 250mm 不计算累计误差 ;
100mm carrier length non parallelism not over 1mm and over 250mm not count accumulate error ;
- 非指明 , 公差范围为 : $\pm 0.1\text{mm}$;
Except special signs , all dimensions tolerance $\pm 0.1\text{mm}$;
- 材料 : 黑色 , 防静电材料 ;
Material : black , anti-static ;
- 所有尺寸符合 EIA-481-E 的要求。
All dimensions accord with EIA-481-E requirement.

卷轴尺寸 Reel Dimension(3000pcs/reel)

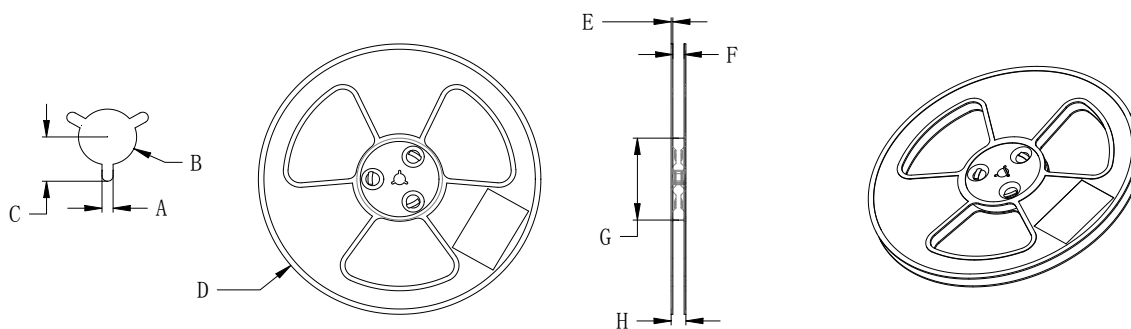

TIEM	A	B	C	D	E	F	G	H
DIM	2.60	13.60	10.80	330.2	2.00	25.20	100.0	29.20
TOLE	±0.20	±0.20	±0.20	±2.0	±0.20	±0.20	±0.20	±0.20

标签 Label:

XSSY® 旭晟半导体 物料标示单			
物料代码		规格型号	
生产批号		生产日期	
电压		数量	
波长		QC判定	
机台号			

XSSY® 深圳市旭晟半导体股份有限公司	
温 馨 提 示	
使用说明:	
1. 开封后, LED产品需在温度不高于30℃, 湿度不高于60%RH的环境中且在12小时内使用完。若未使用完或者开启后湿度卡对应的蓝色圈颜色变为粉红色且超过10%时, 需放入烤箱里除湿处理: 75℃/12H。	
2. 若超出12小时未使用完需抽真空存储并退回旭晟深度除湿处理。	
3. 建议焊接工艺使用回流焊中低温锡膏作业。	

防潮袋包装 Moistureproof static bag packing :

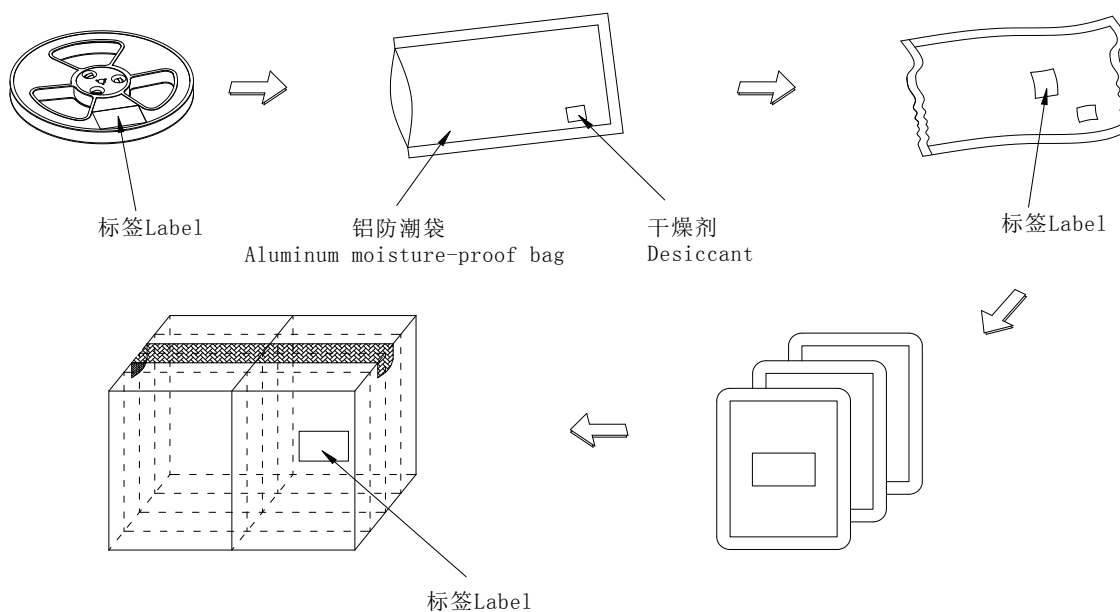

*本产品为潮湿敏感产品, 需放置在密封防静电袋中, 内置干燥剂和湿度卡。

This product is moisture-sensitive and should be placed in a sealed anti-electrostatic bag with a built-in desiccant and humidity card.