

TABLE OF CONTENTS

Features.....	1	Voltage Fault Conditions.....	12
Applications.....	1	Over Current Fault Conditions.....	12
General Description.....	1	Active Diode Mode.....	13
Typical Application.....	1	Applications Information.....	14
Functional Block Diagram.....	3	Power Sequence.....	14
Specifications.....	4	Fault Management.....	14
Electrical Characteristics.....	4	Current Sense and Current Limit.....	14
Absolute Maximum Ratings.....	6	Frequency Selection.....	14
ESD Caution.....	6	Input Capacitors.....	14
Pin Configuration and Function Descriptions.....	7	Inductor Selection.....	14
Typical Performance Characteristics.....	8	Output Capacitors.....	15
Theory of Operation.....	12	Bypassing and Grounding.....	15
Main Control Architecture.....	12	PCB Layout.....	15
Current Sense.....	12	Typical Application.....	16
Temperature Monitor and Overtemperature		Outline Dimensions.....	18
Fault.....	12	Ordering Guide.....	18

REVISION HISTORY**8/2023—Rev. 0 to Rev. A**

Updated Format (Universal).....	1
Changes to Table 1.....	4
Change to Table 2.....	6
Deleted Figure 2; Renumbered Sequentially.....	8
Moved Figure 5.....	8
Deleted Figure 25.....	11
Change to Active Diode Mode Section.....	13
Changes to Power Sequence Section.....	14

7/2022—Revision 0: Initial Version

FUNCTIONAL BLOCK DIAGRAM

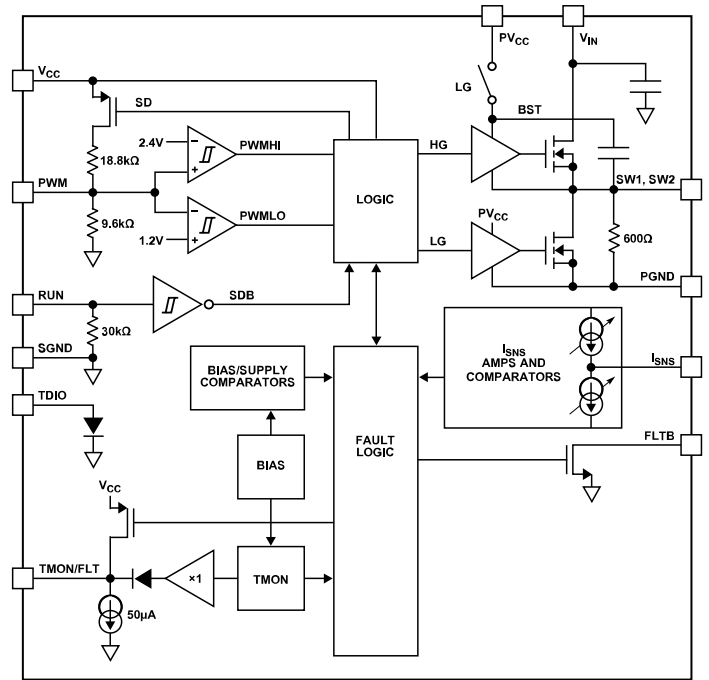

Figure 2.

SPECIFICATIONS

ELECTRICAL CHARACTERISTICS

$T_A = 25^\circ\text{C}$, $V_{IN} = 12\text{ V}$, $PV_{CC} = V_{CC} = 5\text{ V}$, unless otherwise noted.

Table 1.

Parameter ¹	Symbol	Test Conditions/Comments	Min	Typ	Max	Unit
V_{IN} SUPPLY						
Power Input Supply Range	V_{IN}				16	V
V_{IN} Overvoltage Lockout Threshold		V_{IN} Rising	17.7		18.7	V
V_{IN} Overvoltage Lockout Hysteresis				1		V
V_{IN} Overvoltage Lockout Delay ²				1		μs
V_{IN} Shutdown Current		$V_{IN} = 12\text{ V}$, RUN = 0		25		μA
V_{CC} SUPPLY						
V_{CC} Input Supply Range	V_{CC}		4.5	5	5.5	V
V_{CC} Undervoltage Lockout Threshold	$V_{CC(UVLO)}$	V_{CC} Rising	4.05	4.15	4.25	V
V_{CC} Undervoltage Lockout Hysteresis	V_{UVLO_HYST}			0.2		V
V_{CC} Supply Current in Shutdown	$I_{VCC(SD)}$	RUN = 0		14		μA
V_{CC} Supply Current in Active	I_{VCC_active}	RUN = 5 V, PWM = Float		2.5		mA
PV_{CC} SUPPLY						
Driver Input Supply Range	PV_{CC}		4.5	5	5.5	V
PV_{CC} Undervoltage Lockout Threshold	$PV_{CC(UVLO)}$	PV_{CC} Rising	3.9	4.0	4.1	V
PV_{CC} Undervoltage Lockout Hysteresis	PV_{UVLO_HYST}			0.35		V
PV_{CC} Supply Current in Shutdown	$I_{PVCC(SD)}$	RUN = 0		300		μA
PV_{CC} and V_{CC} Supply Current in Active	I_{PVCC_active}	RUN = 5 V, PWM = Float		2.5		mA
UNDERVOLTAGE TIME LOCKOUT DELAY, FROM V_{CC} AND PV_{CC} TO SW LOW ²	t_{UVLO}	PV_{CC} , V_{CC} Rising RUN = 5 V, PWM = 0		1		μs
RUN INPUT						
RUN High Threshold	V_{IH_RUN}	RUN Rising	2.2	2.45	2.7	V
RUN Hysteresis	V_{RUN_HYS}			0.2		V
EN Pull-Down Resistor	R_{PD_RUN}			30		k Ω
Propagation Delay for RUN Low to High ²	T_{d_RUNH}	From RUN Low \geq High to SW = 0, PWM = 0		12		μs
Propagation Delay for RUN High to Low ²	T_{d_RUNL}	From RUN High \geq Low to SW High Z, PWM = 0			0.1	μs
PWM INPUT						
PWM High Threshold	V_{IH_PWM}	$V_{IN} = 1\text{ V}$, $PV_{CC} = 6\text{ V}$			2.7	V
PWM Low Threshold	V_{IL_PWM}	$V_{IN} = 5\text{ V}$	0.8			V
PWM Tri-State Range	V_{TR_PWM}	$V_{IN} = 1\text{ V}$ and 5 V	1.5		2.1	V
PWM Pull-Down Resistor	R_{PD_PWM}	To SGND, $V_{IN} = 5\text{ V}$		9.6		k Ω
PWM Pull-Up Resistor	R_{PU_PWM}	To V_{CC} , $V_{IN} = 5\text{ V}$		18.8		k Ω
Delay Time, PWM High to SW High ²	$t_{PWMHI-SW}$	No Fault Condition		10		ns
Delay Time, PWM Low to SW Low ²	$t_{PWML0-SW}$	No Fault Condition		10		ns
Tri-State to Low Propagation Delay	$t_{Tri_Lo_Delay}$	PWM Going Low to SW Going Low, $V_{IN} = 5\text{ V}$		20		ns
Tri-State to High Propagation Delay	$t_{Tri_Hi_Delay}$	PWM Going High to SW Going High, $V_{IN} = 5\text{ V}$		30		ns
Active to Tri-State Delay Time ²	t_{Tri_Hold}	PWM Going to High Z to SW High Z		20		ns
PWM Minimum ON-Time	t_{PWM_MINON}	$V_{IN} = 5\text{ V}$		20		ns
PWM Floating Voltage	V_{PWM_FLOAT}		1.6	1.7	1.8	V
I_{SNS} OUTPUT						
Current Sense Gain (I_{MON}/I_{OUT})	A_{IMON}	$V_{ISNS} = 1.5\text{ V}$ $I_{OUT} = 5\text{ A}$ to 25 A , PWM = 0, $V_{IN} = 5\text{ V}$	8.5	10	11.5	$\mu\text{A/A}$
Overall Accuracy	I_{SNS}	$I_{OUT} = 50\text{ A}$, $V_{ISNS} = 1.5\text{ V}$, PWM = 0, $V_{IN} = 5\text{ V}$, Accuracy at Trim		500 \pm 40		μA
		$I_{OUT} = -10\text{ A}$, $V_{ISNS} = +1.5\text{ V}$, PWM = 0 ²		100		μA

SPECIFICATIONS

Table 1. (Continued)

Parameter ¹	Symbol	Test Conditions/Comments	Min	Typ	Max	Unit
IMON Operational Voltage Range	V _{IMON}	V _{IN} = 5 V	1.2		2.0	V
FLTB OUTPUT						
Fault Bar Open-Drain Pull-Down Resistance	R _{FLTB-PD}	FLTB Low			1	kΩ
TMON/FLT OUTPUT						
Thermal Monitor Gain ²	A _{TMON}	0°C < T _J < 150°C		8		mV/°C
Thermal Monitor Voltage ²	V _{TMON}	T _J = 0°C		0.6		V
		T _J = 25°C, V _{IN} = 1 V	780	800	825	mV
		T _J = 125°C		1.6		V
Overtemperature Protection Accuracy ²	OTP			150		°C
Overtemperature Hysteresis ²	OTP_Hys			40		°C
Thermal Monitor Maximum Source Current	I _{SOURCE_TMON}	T _J = 25°C, T _{MON} Forced at 0 V, V _{IN} = 1 V		650		μA
Thermal Monitor Maximum Sink Current	I _{SINK_TMON}	T _J = 25°C, T _{MON} Forced at 1.28 V, V _{IN} = 1 V		45		μA
Tdiode Forward Voltage Drop	V _{Tdiode}	T _J = 25°C, I _F = 0.1 mA, V _{IN} = 1 V		678		mV
Tdiode Voltage Drop Temperature Coefficient ²		I _F = 0.1 mA		-1.8		mV/°C
SW NODE						
SW Floating Voltage	V _{SW_Float}	V _{IN} = 12 V, RUN = 5 V		0.7		V
SW Pull-Down Resistance	R _{SW-PGND}	V _{IN} = 5 V		0.6		kΩ
OVERCURRENT LIMITS						
Positive Overcurrent Threshold	I _{_OCP}	PWM = H, V _{IN} = 0.2 V	160	180	200	A
Negative Overcurrent Threshold	I _{_NCP}	PWM = L, V _{IN} = 1 V		-90		A
Positive Overcurrent Blanking Time ²	t _{Blank_OC}	PWM = H		22		ns
Negative Overcurrent Blanking Time ²	t _{Blank_NC}	PWM = L		55		ns
Positive Zero Current Threshold	I _{_ZCP}	V _{IN} = 0.2 V		10		A
Negative Zero Current Threshold	I _{_ZCN}	V _{IN} = 1 V		-16		A

¹ All currents into device pins are positive; all currents out of device pins are negative. All voltages are referenced to ground unless otherwise specified.

² This parameter is not tested but is guaranteed by design.

ABSOLUTE MAXIMUM RATINGS

Table 2.

Parameter	Rating
V _{IN} DC Voltage	–0.3 V to +19 V
V _{IN} Transient Voltage	–0.3 V to +25 V
SW Voltage	–0.3 V to +25 V DC
SW Voltage (20 ns)	–2 V to +25 V
PV _{CC} , V _{CC} Voltage	–0.3 V to +6 V
PWM	–0.3 V to (V _{CC} + 0.3 V)
I _{SNS}	–0.3 V to (V _{CC} + 0.3 V)
FLT _B	–0.3 V to (V _{CC} + 0.3 V)
TDIO Voltage/Current	–0.3 V/+5 mA
Absolute Maximum Junction Temperature ^{1, 2}	125°C
Storage Temperature	–55°C to +150°C
Maximum Reflow (Package Body) Temperature	260°C

¹ The LTC7051-1 is specified over the –40°C to +125°C operating junction temperature range. High Junction temperatures degrade operating lifetimes. Note the maximum ambient temperature consistent with these specifications is determined by specific operating conditions in conjunction with board layout, the rated package thermal impedance and other environmental factors. The junction temperature (T_J, in °C) is calculated from the ambient temperature (T_A in °C) and power dissipation (P_D, in Watts) according to the formula:

$$T_J = T_A + (P_D \times \theta_{JA})$$

where θ_{JA} (in °C/W) is the package thermal impedance.

² The LTC7051-1 includes overtemperature protection that is intended to protect the device during momentary overload conditions. Junction temperature will exceed 125°C when overtemperature protection is active. Continuous operation above the specified maximum operating junction temperature may impair device reliability.

Stresses at or above those listed under Absolute Maximum Ratings may cause permanent damage to the product. This is a stress rating only; functional operation of the product at these or any other conditions above those indicated in the operational section of this specification is not implied. Operation beyond the maximum operating conditions for extended periods may affect product reliability.

ESD CAUTION



ESD (electrostatic discharge) sensitive device. Charged devices and circuit boards can discharge without detection. Although this product features patented or proprietary protection circuitry, damage may occur on devices subjected to high energy ESD. Therefore, proper ESD precautions should be taken to avoid performance degradation or loss of functionality.

PIN CONFIGURATION AND FUNCTION DESCRIPTIONS

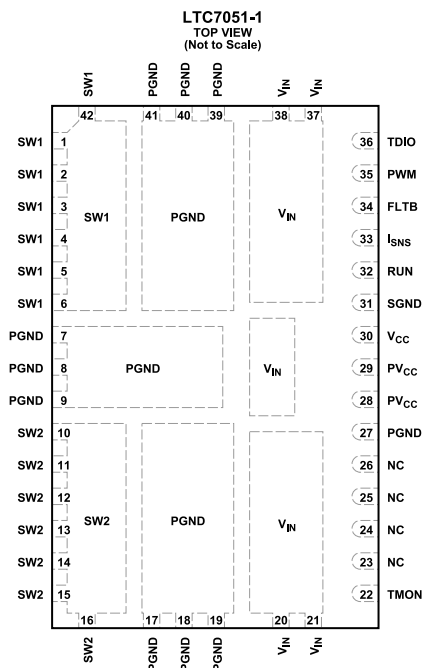

NOTES

- $T_{J(MAX OPER)}$ = 125°C, θ_{JA} = 10.8°C/W ON OPTIMIZED 6-LAYER 3.6 INCHES \times 2.8 INCHES PCB.
- $\theta_{JC(top)}$ = 8.2°C/W; $\theta_{JC(bottom)}$ T = 0.9°C/W; θ VALUES ARE DETERMINED BY SIMULATION PER JESD51 CONDITIONS.
- EXPOSED PADS (VIN, PGND, SW) MUST BE SOLDERED TO PCB.

Figure 3. Pin Configuration

Table 3. Pin Function Descriptions

Pin No.	Mnemonic	Description
1 to 6, 10 to 16, 42	SW1, SW2	Power Stage Switch Node. The output of the power stage, this node is connected to V_{IN} through the high side N-channel FET and to PGND through the low side N-channel FET. SW pins must be connected on the PCB.
7 to 9, 17 to 19, 27, 39 to 41	PGND	Power Stage Ground. This pin is connected to SW through the low side N-channel FET. Also powers the drivers.
20 to 21, 37 to 38	V_{IN}	Power Stage Supply. This pin is connected to SW through the high side N-channel FET.
22	TMON/FLT	Temperature Monitor/Fault Pin. This pin provides a voltage, referred to SGND, of 0.6 V to 1.8 V corresponding to die temperature of 0°C to 150°C for a gain of 8 mV/°C. Above 150°C, the pin is pulled high to indicate an overtemperature (OT) fault. The pin has limited current sinking capability, so multiple like pins can be tied together for highest temperature and single-OT-fault reporting.
28, 29	PVCC	5 V Driver Supply. This pin powers the low side gate driver directly and the high side gate driver through an internal bootstrapped supply riding on SW. Bypass this pin with a 10 μ F ceramic capacitor to PGND in close proximity to chip.
30	VCC	5 V Supply. Bypass this pin with a 1 μ F ceramic capacitor to SGND in close proximity to chip.
31	SGND	Circuit Ground.
32	RUN	Run Pin. When this pin is driven high, the channel is enabled. SW node is in Hi-Z state when RUN is low.
33	ISNS	Current Sense Pin. This pin sources/sinks instantaneous current equal to 1/100,000 the SW node current, positive and negative.
34	FLT	Fault Bar Pin. This open-drain pin pulls down when the chip/channel encounters a fault condition such as OC or OCN.
35	PWM	PWM Input Pin. With RUN driven high, SW will nominally follow this pin high, low, and Hi-Z. Nominal 3 V CMOS logic levels; can be driven with 3 V to 5 V CMOS signals. Resistor divider holds voltage at 1.7 V when in Hi-Z state.
36	TDIO	Temperature Diode Pin. This pin provides a reference diode to SGND for use in measuring die temperature.

TYPICAL PERFORMANCE CHARACTERISTICS

$T_A = 25^\circ\text{C}$, $V_{IN} = 12\text{V}$, $PV_{CC} = V_{CC} = 5\text{V}$, unless otherwise noted.

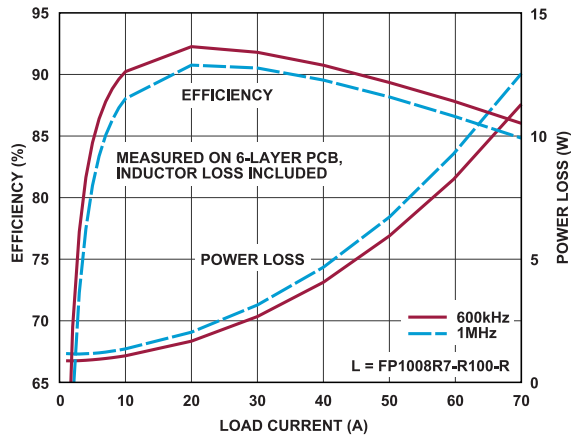

Figure 4. 12 V_{IN} to 1 V_{OUT} Efficiency

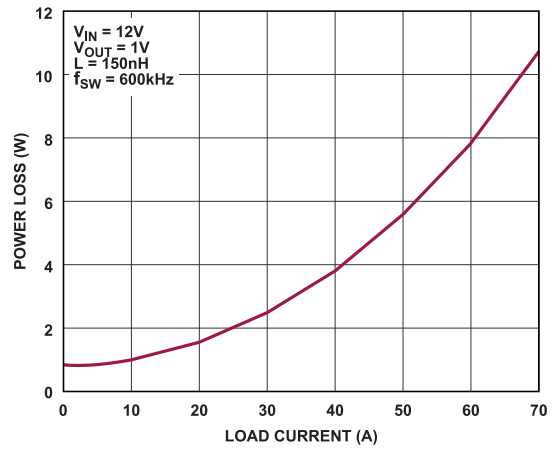

Figure 7. LTC7051-1 Power Dissipation vs. Load

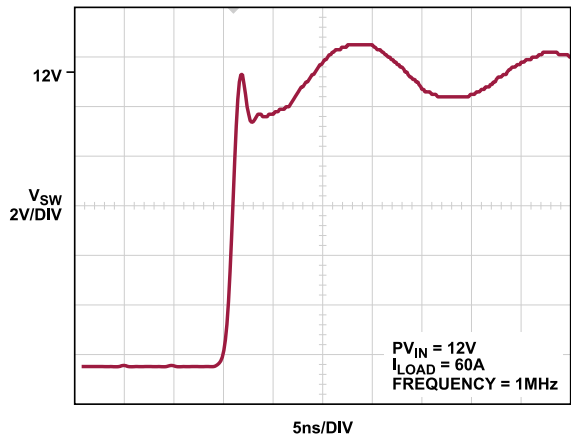

Figure 5. V_{SW} Waveform at 1 MHz

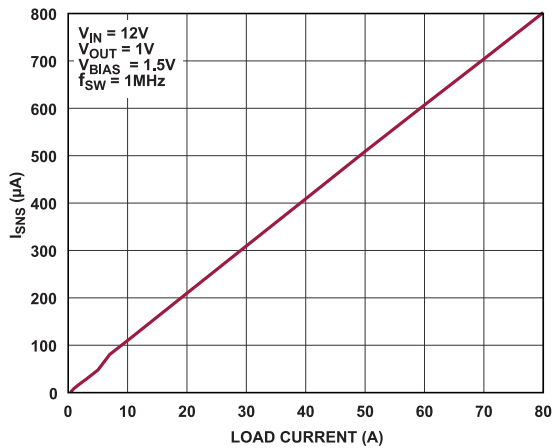

Figure 8. I_{SNS} vs. Load

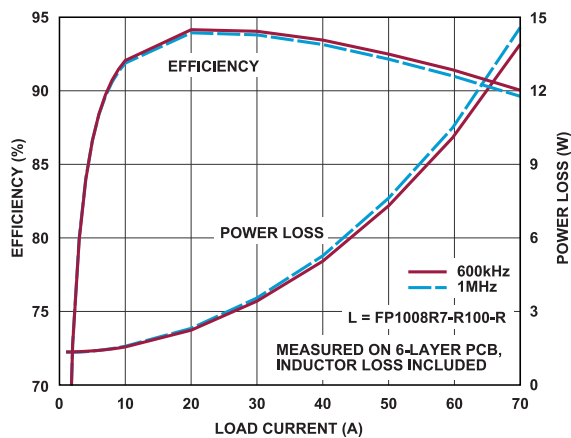

Figure 6. 12 V_{IN} to 1.8 V_{OUT} Efficiency

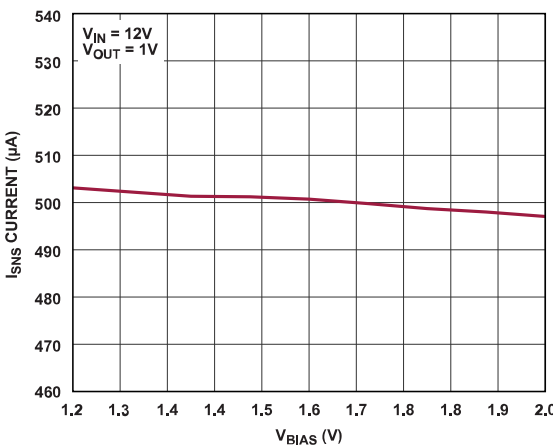

Figure 9. I_{SNS} Current vs. V_{BIAS}

TYPICAL PERFORMANCE CHARACTERISTICS

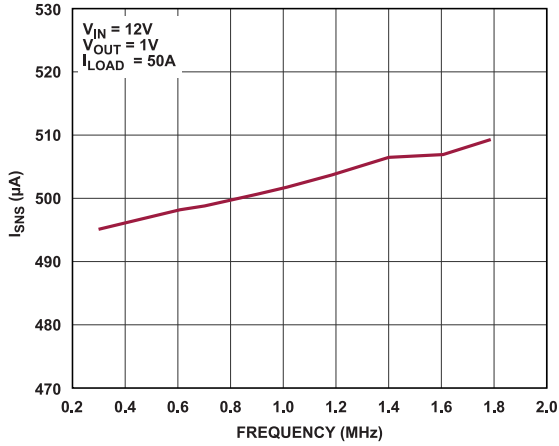

Figure 10. I_{SNS} vs. Frequency

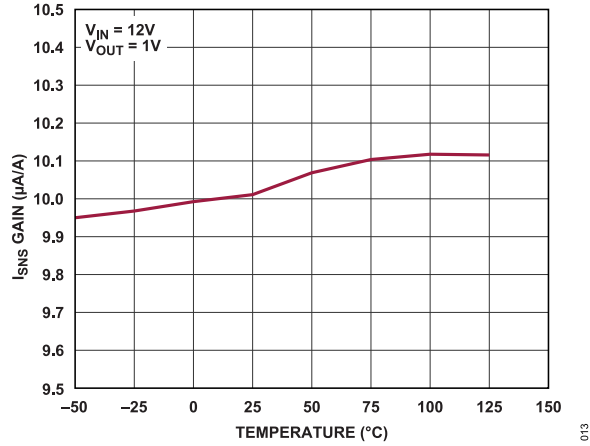

Figure 13. I_{SNS} Gain vs. Temperature

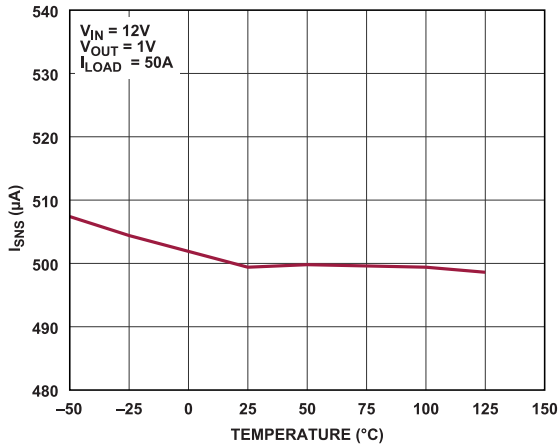

Figure 11. I_{SNS} vs. Temperature

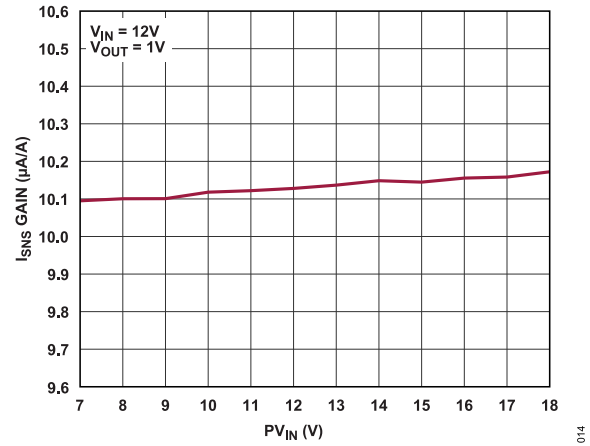

Figure 14. I_{SNS} Gain vs. PV_{IN}

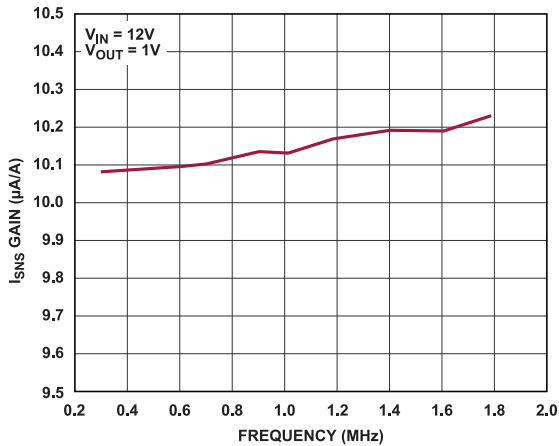

Figure 12. I_{SNS} Gain vs. Frequency

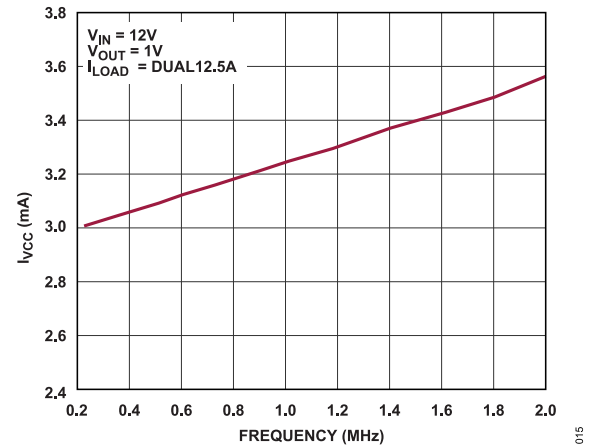

Figure 15. I_{VCC} vs. Frequency

TYPICAL PERFORMANCE CHARACTERISTICS

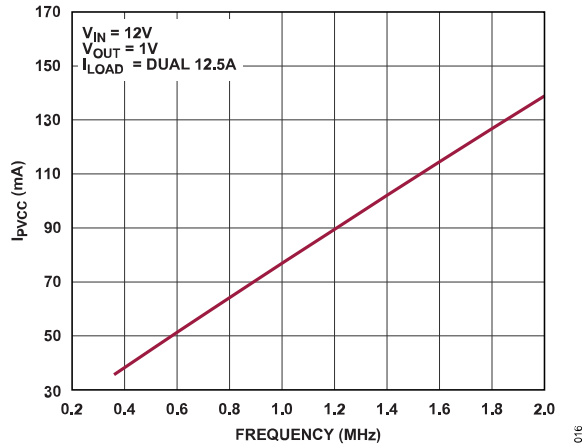

Figure 16. I_{PVCC} vs. Frequency

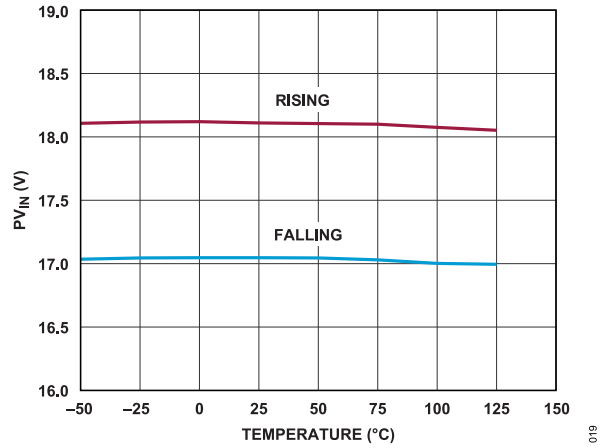

Figure 19. PV_{IN} OVLO vs. Temperature

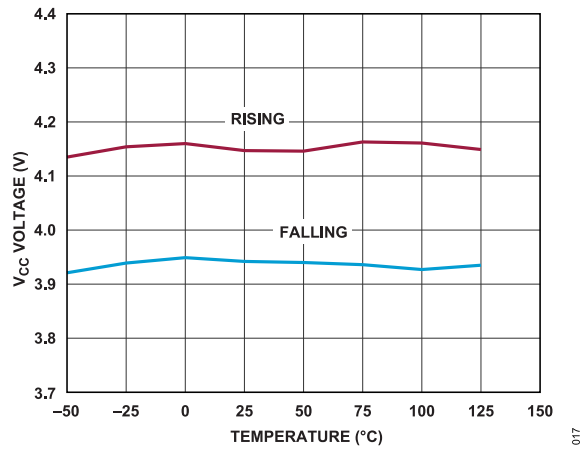

Figure 17. V_{CC} UVLO vs. Temperature

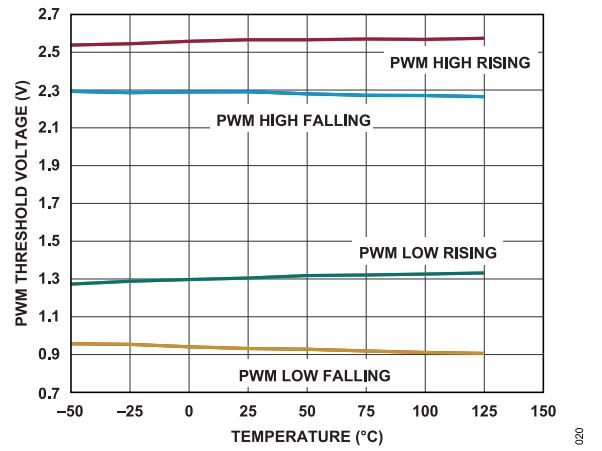

Figure 20. PWM Threshold vs. Temperature

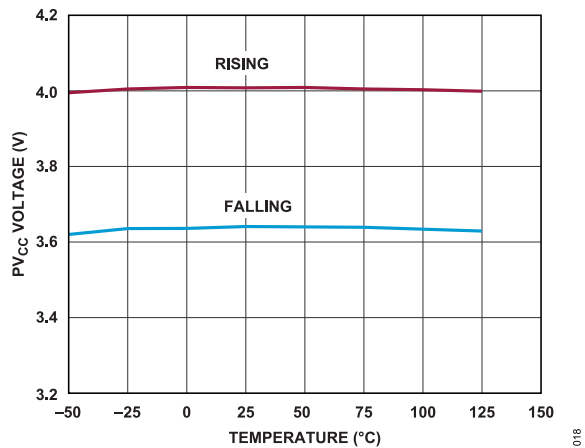

Figure 18. PV_{CC} UVLO vs. Temperature

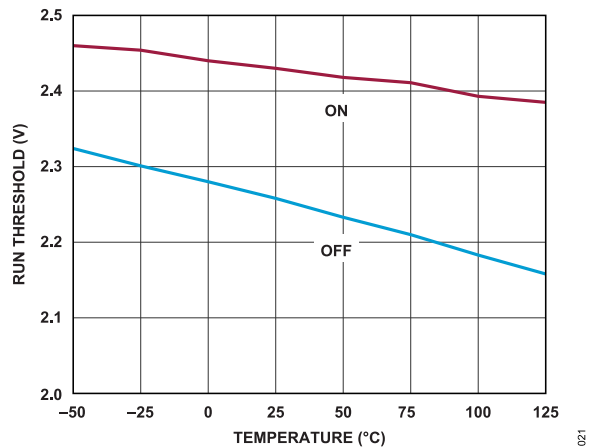

Figure 21. RUN Threshold vs. Temperature

TYPICAL PERFORMANCE CHARACTERISTICS

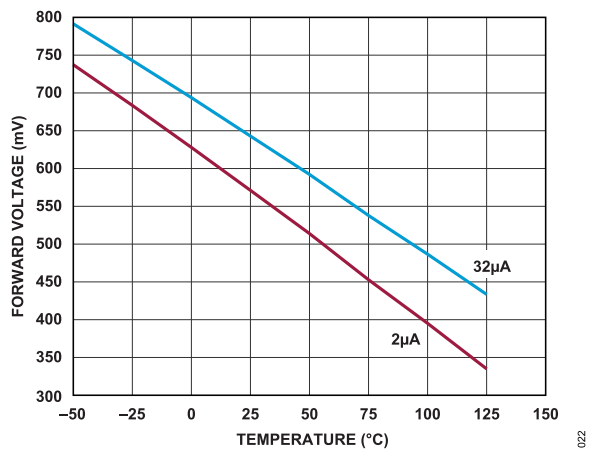

Figure 22. T_{DIODE} Forward Voltage vs. Temperature

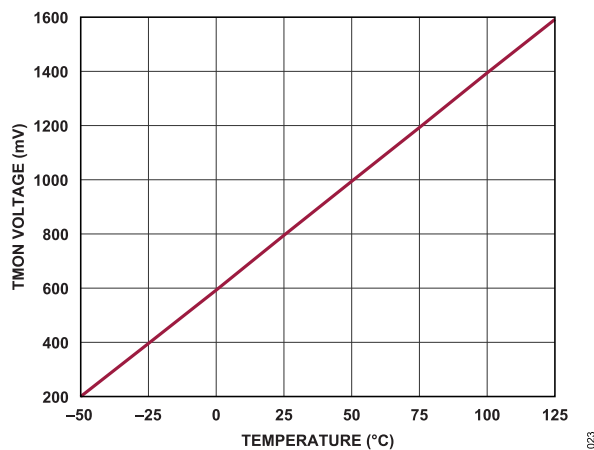

Figure 23. TMON vs. Temperature

THEORY OF OPERATION

MAIN CONTROL ARCHITECTURE

The LTC7051-1 is a single channel integrated-driver half-bridge power MOSFET stage for DC/DC step-down applications. It is designed to be used in a synchronous switching architecture with a controller utilizing 3.3 V or 5 V PWM three-state outputs. The relationship between the transition thresholds and the three input states of the LTC7051-1 is illustrated in Figure 24.

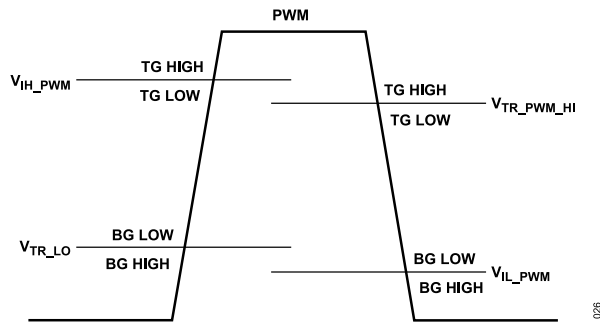

Figure 24. Three-State Input Operation

In normal operation, PWMHI turns on the high side FET, and PWMLO turns on the low side FET. SW node follows the PWM pin with a typical 10 ns delay. There is <1 ns dead time before SW rises from PGND to V_{IN} and a typical 3 ns dead time after SW falls.

The high side FET driver is powered from the internal BST node to SW via an internal integrated switch and capacitor, which allows lower dropout than achievable with a typical diode as well as higher-frequency operation.

CURRENT SENSE

Real-time current sense amplifiers provide a scaled-down version of SW current. During PWMHI or PWMLO, the I_{SNS} pin sources or sinks, according to SW current direction, a current equal to 1/100,000 the instantaneous SW current.

Associated current comparators flag high side FET positive overcurrent (OC) and low side FET negative overcurrent (OCN). Zero-current of both FETs are also detected by associated current comparators.

TEMPERATURE MONITOR AND OVERTEMPERATURE FAULT

Normally, TMON outputs a voltage from 0.6 V to 1.8 V, corresponding to a die temperature range of 0°C to 150°C. The TMON voltage is calculated by:

$$V_{TMON} (V) = 800 \text{ mV} + (T_J (^\circ\text{C}) - 25^\circ\text{C}) \times (8 \text{ mV}/^\circ\text{C})$$

Figure 25 illustrates the relationship between V_{TMON} and die temperature.

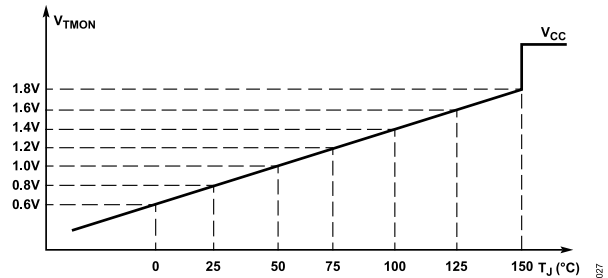

Figure 25. V_{TMON} vs. Die Temperature

TMON is driven by an amplifier that can source current but has limited sinking capacity. This allows multiple TMON pins to be paralleled, with the highest temperature being reported. Overtemperature is triggered at 150°C (typical), and it causes the TMON pin to be pulled high to V_{CC} . The overtemperature fault will be cleared once the internal temperature falls 40°C (typical) below the threshold.

TDIO pin is internally connected to the anode of a P/N junction diode while the cathode is connected to SGND. It provides an alternative measurement of die temperature for the controllers, such as LTC3884-1 to measure the die temperature using direct V_{BE} method or ΔV_{BE} method.

VOLTAGE FAULT CONDITIONS

When V_{CC} or PV_{CC} is in UVLO, or V_{IN} is in OVLO, SW will not respond to PWM and both top FET and bottom FET are off.

When BST-to-SW voltage is in UVLO, SW will not respond to a PWMHI until a PWMLO is provided such that BST-to-SW voltage is recharged sufficiently.

OVER CURRENT FAULT CONDITIONS

When the high side FET is on, instantaneous SW current of >180 A (net current flowing out of SW) will trip the overcurrent (OC) comparator and set the internal OC state. When this happens, regardless of PWM pin state, the high side FET will be turned off, and the low side FET will be turned on until SW current decreases to 10 A, at which point OC state will be reset. Normal PWMHI-to-high-side-FET and PWMLO-to-low-side-FET operation resumes.

When the low side FET is on, instantaneous SW current of <-90 A (net current flowing into SW) will trip the OCN comparator. When this happens, regardless of PWM pin state, the low side FET will be turned off and the high side FET will be turned on until SW current increases to -16 A, at which point OCN state will be reset. Normal PWMHI-to-high-side-FET and PWMLO-to-low-side-FET operation resumes. The trigger and reset of over current condition are illustrated in Figure 26.

In either OC or OCN condition, FLTB is pulled down.

APPLICATIONS INFORMATION

POWER SEQUENCE

The LTC7051-1 requires the following input signals to operate normally: V_{IN} , V_{CC}/PV_{CC} , RUN, and PWM. Make sure that V_{IN} and V_{CC}/PV_{CC} are present and the RUN pin of LTC7051-1 is pulled up before enabling the PWM controller. Do not force RUN pin voltages above V_{CC} voltage.

FAULT MANAGEMENT

The fault management and shutdown mode of LTC7051-1 is summarized in Table 4. Connecting the open-drain output FLT_B pin to the controller's RUN pin can prevent the controller from starting up and force the converter to restart once the LTC7051-1 runs into fault conditions, except BST-to-SW undervoltage fault.

Table 4. Fault Management and Shutdown Mode Summary

	FLT_B	Respond TO PWM	TMON
V_{IN} OVLO	Low	No, Both FETs Off When I_{SW} = 0	Report Temperature
V_{CC} UVLO	Low	No, Both FETs Immediate Off	Floating
PV_{CC} UVLO	Low	No, Both FETs Off When I_{SW} = 0.	Report Temperature
Positive OC	Low	No, Top FET Immediate Off	Report Temperature
Negative OC	Low	No, Bottom FET Immediate Off	Report Temperature
Overtemperature	Low	Yes	Pull Up to V_{CC} .
BST-to-SW UV	High	Ignore PWMHI	Report Temperature
RUN Shutdown	Low	No, Both FETs Immediate Off	Floating

CURRENT SENSE AND CURRENT LIMIT

I_{SNS} sources and sinks a current which is 1/100,000 of the SW current. According to the controller's maximum current sense signal range, select a proper resistor to convert the I_{SNS} current into a differential voltage signal reflecting the real-time SW current. The resistor should be biased at a low impedance common mode voltage, which has current sinking and sourcing capability. Make sure that at the maximum positive current and negative current, the I_{SNS} pin voltage is in the specified range so that the gain I_{SNS}/I_{SW} remains constant.

A general LTC7051-1 application circuit is shown on the first page of this data sheet. LTC7051-1 is optimized for the application of high frequency high current voltage regulator. External component selection is largely driven by the load requirement and begins with the selection of the switching frequency f_{SW} and inductor L. Once the inductor is chosen, the input capacitor, C_{IN} , the output capacitor, C_{OUT} , can be selected. The I_{SNS} resistors are selected to set the current limit.

FREQUENCY SELECTION

The selection of switching frequency is a trade-off between efficiency and component size. Low frequency operation increases efficiency by reducing FET switching losses, but requires larger inductance and/or capacitance to maintain low output ripple voltage.

In the selection of switching frequency, make sure that the high side on-time at maximum input voltage is longer than LTC7051-1's minimum on-time, $t_{ON(MIN)}$, which is the smallest time duration that the LTC7051-1 is capable of turning on the top FET. It is determined by internal timing delays, power stage timing delays and the gate charge required to turn on the top FET. Low duty cycle applications may approach this minimum on-time limit (see Equation 1).

$$t_{ON(MIN)} < \frac{V_{OUT}}{V_{IN} \times f_{SW}} \quad (1)$$

INPUT CAPACITORS

The LTC7051-1 should be connected to a V_{IN} supply through low impedance power planes. Ceramic input capacitors should be placed as close to the package as physically possible, with size and quantity appropriate for temperature rise with ripple current as calculated below.

For a buck converter, the switching duty cycle can be estimated by Equation 2.

$$D = \frac{V_{OUT}}{V_{IN}} \quad (2)$$

Without considering the inductor ripple current, for each output, the RMS current of the input capacitor can be estimated by Equation 3.

$$I_{CIN(RMS)} = \frac{I_{OUT(MAX)}}{\eta} \times \sqrt{D \times (1 - D)} \quad (3)$$

where η is the estimated efficiency of the power section.

INDUCTOR SELECTION

Given the desired input and output voltages, the inductor value and operating frequency, f_{OSC} , directly determine the inductor's peak-to-peak ripple current (see Equation 4).

$$I_{RIPPLE} = \frac{V_{OUT}}{V_{IN}} \left(\frac{V_{IN} - V_{OUT}}{f_{SW} \times L} \right) \quad (4)$$

Lower ripple current reduces core losses in the inductor, ESR losses in the output capacitors and output voltage ripple. Thus, highest efficiency operation is obtained at low frequency with a small ripple current. Achieving this, however, requires a large inductor. A reasonable starting point is to choose a ripple current that is about 40% of $I_{OUT(MAX)}$. Note that the largest ripple current occurs at the highest input voltage. To guarantee that ripple current does not exceed a specified maximum, the inductor should be chosen according to Equation 5.

$$L \geq \left(\frac{V_{IN} - V_{OUT}}{f_{SW} \times I_{RIPPLE}} \right) \times \frac{V_{OUT}}{V_{IN}} \quad (5)$$

Once the inductance value is determined, the type of inductor must be selected. Core loss is independent of core size for a fixed inductor value, but it is very dependent on inductance selected. As inductance increases, core losses go down. Unfortunately, increased inductance requires more turns of wire and therefore copper losses will increase. Ferrite designs have very low core

APPLICATIONS INFORMATION

loss and are preferred at high switching frequencies, so design goals can concentrate on copper loss and preventing saturation. Ferrite core material saturates hard, which means that inductance collapses abruptly when the peak design current is exceeded. This results in an abrupt increase in inductor ripple current and consequent output voltage ripple. Do not allow the core to saturate!

OUTPUT CAPACITORS

The LTC7051-1 is designed for high frequency switching and low output voltage ripple noise. The bulk output capacitors defined as C_{OUT} are chosen with low enough effective series resistance (ESR) to meet the output voltage ripple and transient requirements. C_{OUT} can be a low ESR tantalum capacitor, a low ESR polymer capacitor, or ceramic capacitors. At 1 MHz, the typical output capacitance range is from 500 μF to 1000 μF . Additional output filtering may be required by the system designer if further reduction of output ripple or dynamic transient spikes is required.

BYPASSING AND GROUNDING

The LTC7051-1 requires proper bypassing on the PV_{CC} and V_{CC} supplies due to its high speed switching (nanoseconds) and large AC currents (amperes). Careless component placement and PCB trace routing may cause excessive ringing and under/overshoot. Follow the following steps to obtain the optimum performance from the LTC7051-1.

- ▶ Mount the bypass capacitors as close as possible between the V_{CC} and $SGND$ pins, and the PV_{CC} and $PGND$ pins. The traces should be shortened as much as possible to reduce lead inductance.
- ▶ Use a low inductance, low impedance ground plane to reduce any ground drop and stray capacitance. Any significant ground drop will degrade signal integrity.

- ▶ Plan the power/ground routing carefully. Know where the large load switching current is coming from and going to. Maintain separate ground return paths for the input pin and the output power stage.
- ▶ Be sure to solder the Exposed Pad on the back side of the LTC7051-1 packages to the board. Failure to make good thermal contact between the exposed back side and the copper board will result in far greater thermal resistances.

PCB LAYOUT

Due to the LTC7051-1's high power density and high speed, high frequency operation, proper PCB layout and composition are critical to maximizing performance.

At a minimum, the PCB should be 4-layer with at least top and bottom layers 2 oz. copper. As much as possible, top and bottom layers should be continuous V_{IN} and $PGND$ areas. At least one inner layer, preferably the second, should be a continuous $PGND$ plane.

Copper-filled vias should be used under the package exposed pads to connect top and bottom PCB layers. $\theta_{JCbottom}$ is $<1^\circ\text{C/W}$. Anything less than copper-filled vias will compromise θ_{JA} greatly.

The inductor pads should be placed as close as possible to the package, with traces as short and wide as possible. If possible, SW traces should be doubled up with the second layer, taking care not to couple to sensitive traces.

A recommended PCB layout is shown in [Figure 28](#).

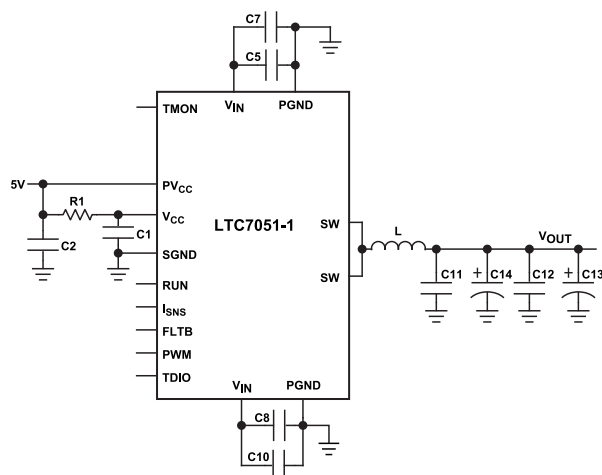

Figure 27. Schematic

APPLICATIONS INFORMATION

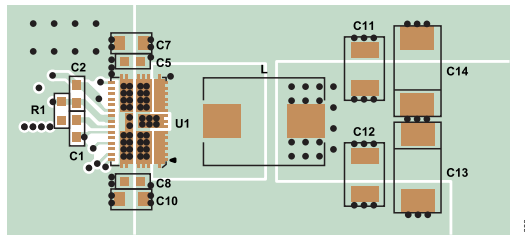

Figure 28. Example PCB Layout

TYPICAL APPLICATION

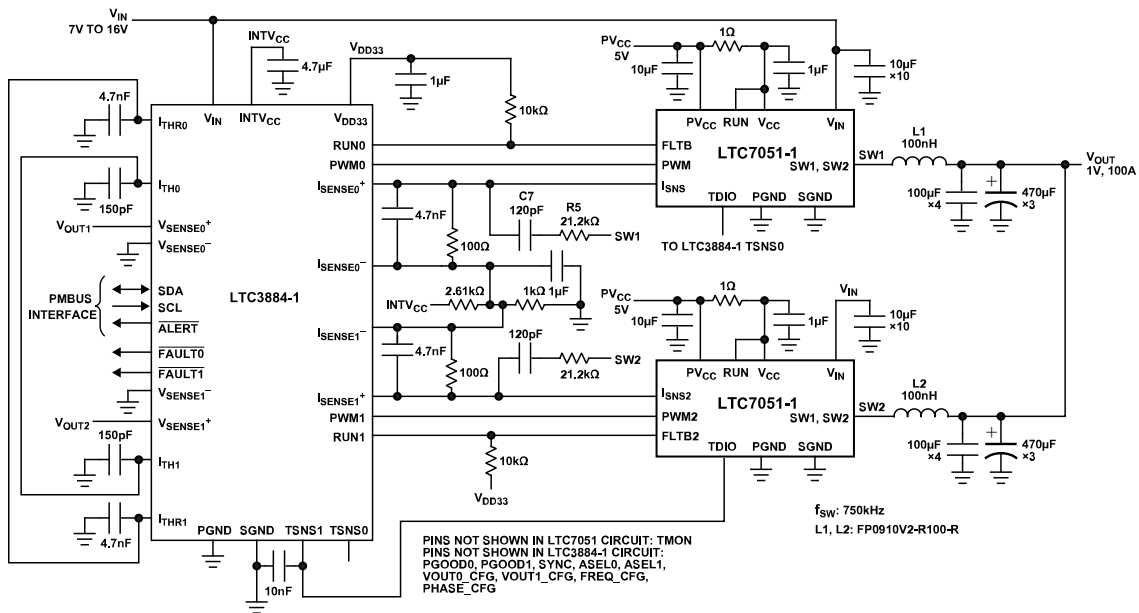

Figure 29.

Related Parts

Table 5.

Part Number	Description	Comments
LTC7051	SilentMOS Smart Power Stage in 5 mm × 8 mm LQFN	140 A Peak Current, Silent Switcher 2 Architecture, V_{IN} Up to 14 V, 5 mm × 8 mm LQFN Package
LTC7050	Dual SilentMOS Smart Power Stage in 5mm × 8mm LQFN	70 A Peak Current per Channel, Silent Switcher 2 Architecture, V_{IN} Up to 14 V, 5 mm × 8 mm LQFN Package
LTC7050-1	Dual SilentMOS Smart Power Stage in 5mm × 8mm LQFN	70 A Peak Current per Channel, Silent Switcher 2 Architecture, V_{IN} Up to 16 V, 5 mm × 8 mm LQFN Package
LTC3888/LTC3888-1	Dual Output 8-Phase Step-Down DC/DC Controller with Digital Power System Management	$4.5 V \leq V_{IN} \leq 26.5 V$, $0.3 V \leq V_{OUT} \leq 3.45 V$, $I^2C/PMBus$, Programmable Loop Compensation, 5 mm × 8 mm QFN-52
LTC3884/LTC3884-1	Dual Output PolyPhase Step-Down Controller with Sub-Milliohm DCR Sensing and Digital Power System Management	$4.5 V \leq V_{IN} \leq 38 V$, $0.5 V \leq V_{OUT} \leq 5.5 V$, $I^2C/PMBus$, Programmable Loop Compensation, 5 mm × 8 mm QFN-52
LTC7851	Quad Output Multiphase Step-Down Voltage Mode DC/DC Controller with Accurate Current Sharing	Operates with DrMOS, Power Blocks or External Drivers/MOSFETs, V_{IN} Range Depends on External Components, $4.5 V \leq V_{CC} \leq 5.5 V$, $0.6 V \leq V_{OUT} \leq V_{CC} - 0.5 V$
LTC7852/LTC7852-1	Dual Output 6-Phase Current Mode Synchronous Buck Controller with Current Monitoring	Operates with DrMOS, Power Blocks, $0.5 V \leq V_{OUT} \leq 2 V$, Hiccup Mode Overcurrent Protection, Flexible Phase Configuration

APPLICATIONS INFORMATION

Table 5. (Continued)

Part Number	Description	Comments
LTC3861	Dual, Multiphase Step-Down Voltage Mode DC/DC Controller with Accurate Current Sharing	Operates with Power Blocks, DrMOS or External Drivers/MOSFETs $3\text{ V} \leq V_{IN} \leq 24\text{ V}$
LTC3882/LTC3882-1	Dual Output Multiphase Step-Down DC/DC Voltage Mode Controller with Digital Power System Management	$3\text{ V} \leq V_{IN} \leq 38\text{ V}$, $0.5\text{ V} \leq V_{OUT1,2} \leq 5.25\text{ V}$, $\pm 0.5\%$ V_{OUT} Accuracy I ² C/PMBus Interface, uses DrMOS or Power Blocks
LTC3887/LTC3887-1	Dual Output Multiphase Step-Down DC/DC Controller with Digital Power System Management, 70 mS Start-Up	$4.5\text{ V} \leq V_{IN} \leq 24\text{ V}$, $0.5\text{ V} \leq V_{OUT0,1} (\pm 0.5\%) \leq 5.5\text{ V}$, 70 mS Start-Up, I ² C/PMBus Interface, -1 Version uses DrMOS or Power Blocks

OUTLINE DIMENSIONS

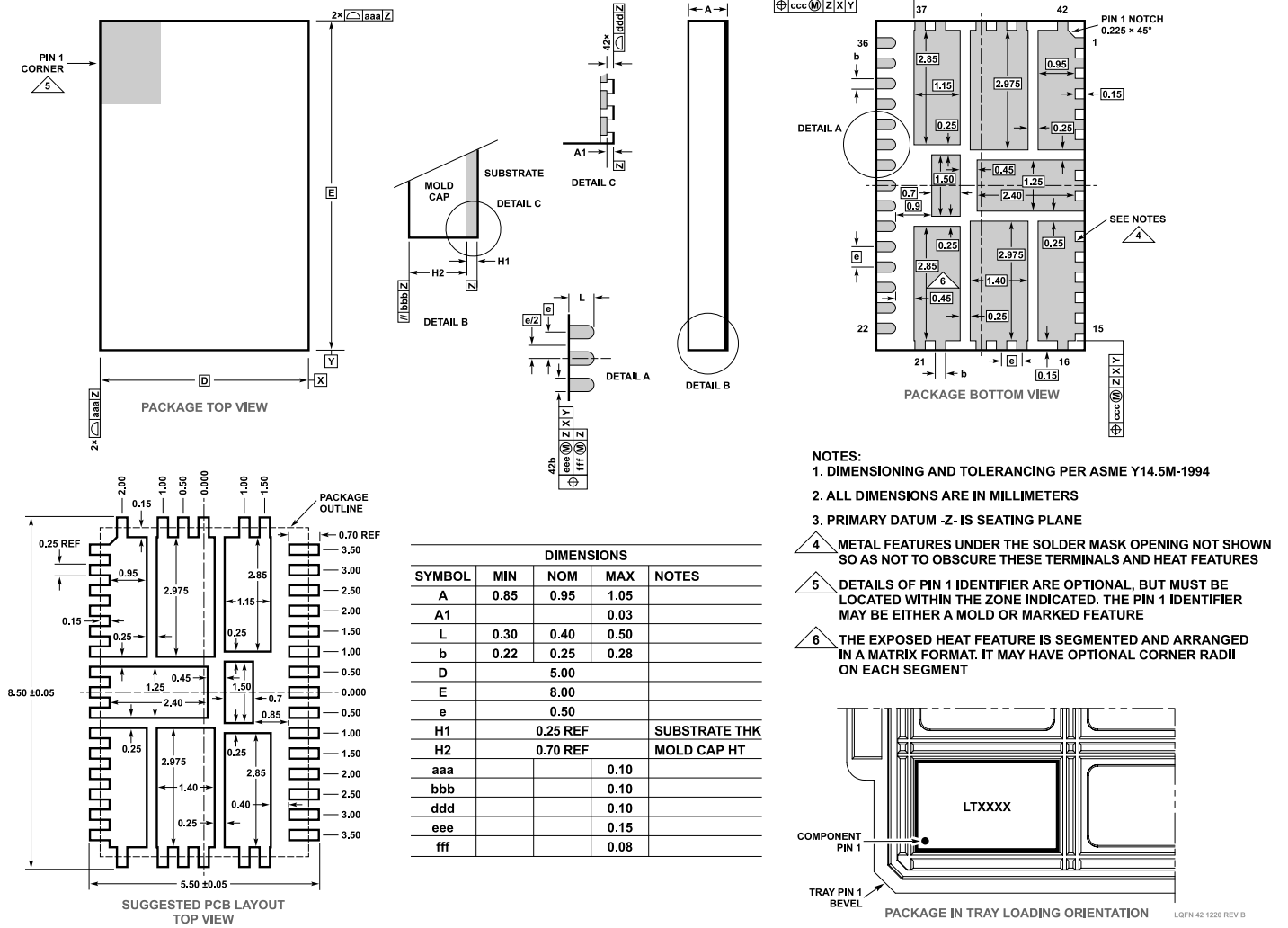

Figure 30. 42-Lead, 5 mm x 8 mm x 0.95 mm, LQFN Package (05-08-1571)
 Dimensions shown in millimeters

Updated: July 18, 2023

ORDERING GUIDE

Model ¹	Temperature Range	Package Description	Package Option
LTC7051AV-1#PBF	-40°C to +125°C	42-Lead LQFN (8mm x 5mm x 0.95mm w/ EP)	05-08-1571

¹ All models are RoHS compliant.