

AD7394/AD7395

FEATURES

Micropower: 100 μ A/DAC
0.1 μ A Typical Power Shutdown
Single-Supply +2.7 V to +5.5 V Operation
Compact 1.1 mm Height TSSOP-14 Package
AD7394/12-Bit Resolution
AD7395/10-Bit Resolution
Serial Interface with Schmitt Trigger Inputs

APPLICATIONS

Automotive Output Span Voltage
Portable Communications
Digitally Controlled Calibration
PC Peripherals

GENERAL DESCRIPTION

The AD7394/AD7395 family of dual, 12-/10-bit, voltage output digital-to-analog converters is designed to operate from a single +3 V supply. Built using a CBCMOS process, this monolithic DAC offers the user low cost and ease of use in single-supply +3 V systems. Operation is guaranteed over the supply voltage range of +2.7 V to +5.5 V making this device ideal for battery operated applications.

The full-scale output voltage is determined by the applied external reference input voltage, V_{REF} . The rail-to-rail V_{REF} input to V_{OUT} outputs allows for a full-scale voltage set equal to the positive supply V_{DD} or any value in between.

A doubled-buffered serial data interface offers high speed, microcontroller compatible inputs using serial-data-in (SDI), clock (CLK) and load strobe ($\overline{LDA} + \overline{LDB}$) pins. A chip-select (\overline{CS}) pin simplifies connection of multiple DAC packages by enabling the clock input when active low. Additionally, an \overline{RS} input sets the output to zero scale or to 1/2 scale based on the logic level applied to the MSB pin. The power shutdown pin, \overline{SHDN} , reduces power dissipation to nanoamp current levels. All digital inputs contain Schmitt-triggered logic levels to minimize power dissipation and prevent false triggering on the clock input.

Both parts are offered in the same pinout to allow users to select the amount of resolution appropriate for their application without circuit card redesign.

FUNCTIONAL BLOCK DIAGRAM

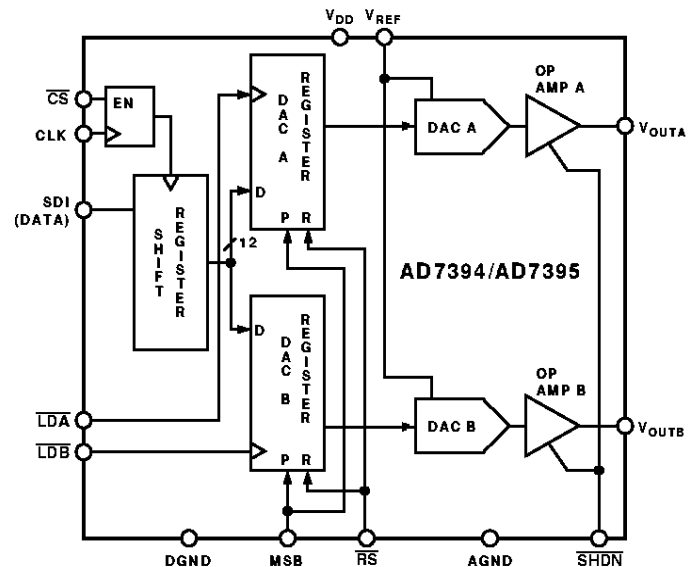

The AD7394/AD7395 is specified over the extended industrial (-40°C to $+85^{\circ}\text{C}$) temperature range. Packages available include plastic DIP and low profile 1.75 mm height SO-14 surface mount packages. The AD7395ARU is available for ultracompact applications in a thin 1.1 mm TSSOP-14 package. For automotive applications the AD7395AR is specified for operation over the (-40°C to $+125^{\circ}\text{C}$) temperature range.

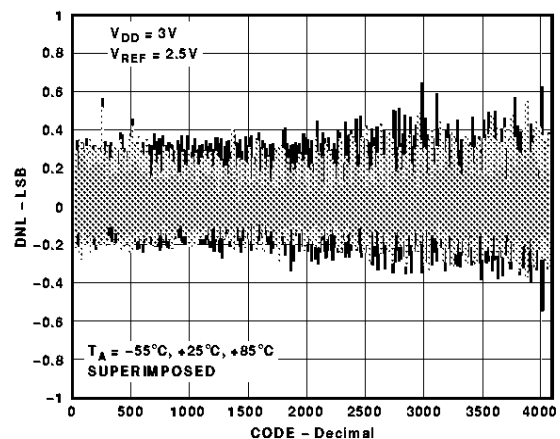

Figure 1. Differential Nonlinearity Error vs. Code

REV. 0

Information furnished by Analog Devices is believed to be accurate and reliable. However, no responsibility is assumed by Analog Devices for its use, nor for any infringements of patents or other rights of third parties which may result from its use. No license is granted by implication or otherwise under any patent or patent rights of Analog Devices.

AD7394/AD7395—SPECIFICATIONS

AD7394 12-BIT RAIL-TO-RAIL VOLTAGE OUT DAC

ELECTRICAL CHARACTERISTICS (@ $V_{REF\ IN} = 2.5\ V$, $-40^{\circ}\text{C} < T_A < +85^{\circ}\text{C}$, unless otherwise noted)

Parameter	Symbol	Conditions	3 V \pm 10%	5 V \pm 10%	Units
STATIC PERFORMANCE					
Resolution ¹	N		12	12	Bits
Relative Accuracy ²	INL	$T_A = +25^{\circ}\text{C}$	± 1.5	± 1.5	LSB max
Relative Accuracy ²	INL	$T_A = -40^{\circ}\text{C}, +85^{\circ}\text{C}$	± 2.0	± 2.0	LSB max
Differential Nonlinearity ²	DNL	$T_A = +25^{\circ}\text{C}$, Monotonic	± 0.9	± 0.9	LSB max
Differential Nonlinearity ²	DNL	Monotonic	± 1	± 1	LSB max
Zero-Scale Error	V_{ZSE}	Data = 000 _H	4.0	4.0	mV max
Full-Scale Voltage Error	V_{FSE}	$T_A = +25^{\circ}\text{C}, +85^{\circ}\text{C}$, Data = FFF _H	± 8	± 8	mV max
Full-Scale Voltage Error	V_{FSE}	$T_A = -40^{\circ}\text{C}$, Data = FFF _H	± 20	± 20	mV max
Full-Scale Tempco ³	TCV_{FS}		-30	-30	ppm/ $^{\circ}\text{C}$ typ
REFERENCE INPUT					
$V_{REF\ IN}$ Range	V_{REF}		0/ V_{DD}	0/ V_{DD}	V min/max
Input Resistance	R_{REF}		2.5	2.5	M Ω typ ⁴
Input Capacitance ³	C_{REF}		5	5	pF typ
ANALOG OUTPUT					
Output Current (Source)	I_{OUT}	Data = 800 _H , $\Delta V_{OUT} = 5\ \text{LSB}$	1	1	mA typ
Output Current (Sink)	I_{OUT}	Data = 800 _H , $\Delta V_{OUT} = 5\ \text{LSB}$	3	3	mA typ
Capacitive Load ³	C_L	No Oscillation	100	100	pF typ
LOGIC INPUTS					
Logic Input Low Voltage	V_{IL}		0.5	0.8	V max
Logic Input High Voltage	V_{IH}		$V_{DD}-0.6$	4.0	V min
Input Leakage Current	I_{IL}		10	10	μA max
Input Capacitance ³	C_{IL}		10	10	pF max
INTERFACE TIMING^{3, 5}					
Clock Width High	t_{CH}		50	30	ns min
Clock Width Low	t_{CL}		50	30	ns min
Load Pulsewidth	t_{LDW}		30	20	ns min
Data Setup	t_{DS}		10	10	ns min
Data Hold	t_{DH}		30	15	ns min
Clear Pulsewidth	$t_{CLR\ W}$		15	15	ns min
Load Setup	t_{LD1}		30	15	ns min
Load Hold	t_{LD2}		40	20	ns min
AC CHARACTERISTICS					
Output Slew Rate	SR	Data = 000 _H to FFF _H to 000 _H	0.05	0.05	V/ μs typ
Settling Time ⁶	t_S	To $\pm 0.1\%$ of Full Scale	70	60	μs typ
DAC Glitch	Q	Code 7FF _H to 800 _H to 7FF _H	65	65	nV/s typ
Digital Feedthrough	Q		15	15	nV/s typ
Feedthrough	V_{OUT}/V_{REF}	$V_{REF} = 1.5\ V_{DC} + 1\ V\ \text{p-p}$, Data = 000 _H , $f = 100\ \text{kHz}$	-63	-63	dB typ
SUPPLY CHARACTERISTICS					
Power Supply Range	$V_{DD\ \text{RANGE}}$	$\text{DNL} < \pm 1\ \text{LSB}$	2.7/5.5	2.7/5.5	V min/max
Shutdown Supply Current	$I_{DD\ \text{SD}}$	$\text{SHDN} = 0$, $V_{IL} = 0\ \text{V}$, No Load	0.1/1.5	0.1/1.5	μA typ/max
Positive Supply Current	I_{DD}	$V_{IL} = 0\ \text{V}$, No Load	125/200	125/200	μA typ/max
Power Dissipation	P_{DISS}	$V_{IL} = 0\ \text{V}$, No Load	600	1000	μW max
Power Supply Sensitivity	PSS	$\Delta V_{DD} = \pm 5\%$	0.006	0.006	%/% max

NOTES

¹One LSB = $V_{REF}/4096\ \text{V}$ for the 12-bit AD7394.

²The first two codes (000_H, 001_H) are excluded from the linearity error measurement.

³These parameters are guaranteed by design and not subject to production testing.

⁴Typicals represent average readings measured at $+25^{\circ}\text{C}$.

⁵All input control signals are specified with $t_R = t_F = 2\ \text{ns}$ (10% to 90% of +3 V) and timed from a voltage level of 1.6 V.

⁶The settling time specification does not apply for negative going transitions within the last three LSBs of ground.

Specifications subject to change without notice.

AD7395 10-BIT RAIL-TO-RAIL VOLTAGE OUT DAC

ELECTRICAL CHARACTERISTICS (@ $V_{REFIN} = 2.5\text{ V}$, $-40^{\circ}\text{C} < T_A < +85^{\circ}\text{C}/+125^{\circ}\text{C}$, unless otherwise noted)

Parameter	Symbol	Conditions	3 V \pm 10%	5 V \pm 10%	Units
STATIC PERFORMANCE					
Resolution ¹	N		10	10	Bits
Relative Accuracy ²	INL	$T_A = +25^{\circ}\text{C}$	± 1.5	± 1.5	LSB max
Relative Accuracy ²	INL	$T_A = -40^{\circ}\text{C}, +85^{\circ}\text{C}, +125^{\circ}\text{C}$	± 2.0	± 2.0	LSB max
Differential Nonlinearity ²	DNL	Monotonic	± 1	± 1	LSB max
Zero-Scale Error	V_{ZSE}	Data = 000 _H	9.0	9.0	mV max
Full-Scale Voltage Error	V_{FSE}	$T_A = +25^{\circ}\text{C}, +85^{\circ}\text{C}, +125^{\circ}\text{C}$ Data = FFF _H	± 42	± 42	mV max
Full-Scale Voltage Error	V_{FSE}	$T_A = -40^{\circ}\text{C}$, Data = FFF _H	± 48	± 48	mV max
Full-Scale Tempco ³	TCV _{FS}		-35	-35	ppm/ $^{\circ}\text{C}$ typ
REFERENCE INPUT					
V_{REFIN} Range	V_{REF}		0/ V_{DD}	0/ V_{DD}	V min/max
Input Resistance	R_{REF}		2.5	2.5	M Ω typ ⁴
Input Capacitance ³	C_{REF}		5	5	pF typ
ANALOG OUTPUT					
Output Current (Source)	I_{OUT}	Data = 200 _H , $\Delta V_{OUT} = 5\text{ LSB}$	1	1	mA typ
Output Current (Sink)	I_{OUT}	Data = 200 _H , $\Delta V_{OUT} = 5\text{ LSB}$	3	3	mA typ
Capacitive Load ³	C_L	No Oscillation	100	100	pF typ
LOGIC INPUTS					
Logic Input Low Voltage	V_{IL}		0.5	0.8	V max
Logic Input High Voltage	V_{IH}		$V_{DD}-0.6$	4.0	V min
Input Leakage Current	I_{IL}		10	10	μA max
Input Capacitance ³	C_{IL}		10	10	pF max
INTERFACE TIMING^{3, 5}					
Clock Width High	t_{CH}		50	30	ns min
Clock Width Low	t_{CL}		50	30	ns min
Load Pulsewidth	t_{LDW}		30	20	ns min
Data Setup	t_{DS}		10	10	ns min
Data Hold	t_{DH}		30	15	ns min
Clear Pulsewidth	t_{CLR}		15	15	ns min
Load Setup	t_{LD1}		30	15	ns min
Load Hold	t_{LD2}		40	20	ns min
AC CHARACTERISTICS					
Output Slew Rate	SR	Data = 000 _H to 3FF _H to 000 _H	0.05	0.05	V/ μs typ
Settling Time ⁶	t_S	To $\pm 0.1\%$ of Full Scale	70	60	μs typ
DAC Glitch	Q	Code 7FF _H to 800 _H to 7FF _H	65	65	nV/s typ
Digital Feedthrough	Q		15	15	nV/s typ
Feedthrough	V_{OUT}/V_{REF}	$V_{REF} = 1.5\text{ V}_{DC} + 1\text{ V p-p}$, Data = 000 _H , $f = 100\text{ kHz}$	-63	-63	dB typ
SUPPLY CHARACTERISTICS					
Power Supply Range	$V_{DD\text{ RANGE}}$	DNL $< \pm 1\text{ LSB}$	2.7/5.5	2.7/5.5	V min/max
Shutdown Supply Current	I_{DD_SD}	$\overline{\text{SHDN}} = 0$, $V_{IL} = 0\text{ V}$, No Load	0.1/1.5	0.1/1.5	μA typ/max
Positive Supply Current	I_{DD}	$V_{IL} = 0\text{ V}$, No Load	125/200	125/200	μA typ/max
Power Dissipation	P_{DISS}	$V_{IL} = 0\text{ V}$, No Load	600	1000	μW max
Power Supply Sensitivity	PSS	$\Delta V_{DD} = \pm 5\%$	0.006	0.006	%% max

NOTES

¹One LSB = $V_{REF}/4096\text{ V}$ for the 10-bit AD7395.

²The first two codes (000_H, 001_H) are excluded from the linearity error measurement.

³These parameters are guaranteed by design and not subject to production testing.

⁴Typicals represent average readings measured at $+25^{\circ}\text{C}$.

⁵All input control signals are specified with $t_R = t_F = 2\text{ ns}$ (10% to 90% of $+3\text{ V}$) and timed from a voltage level of 1.6 V .

⁶The settling time specification does not apply for negative going transitions within the last three LSBs of ground.

Specifications subject to change without notice.

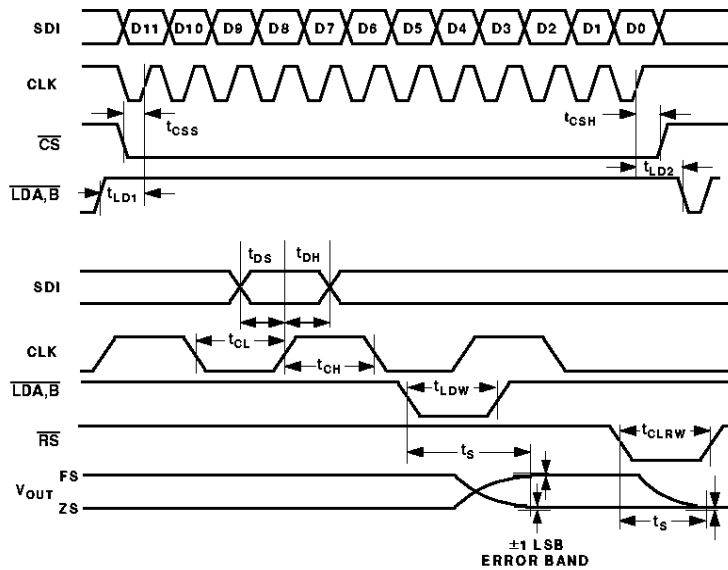

Figure 2. Timing Diagram

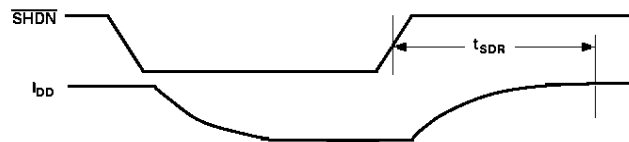

Figure 3. Timing Diagram

Table I. Control Logic Truth Table

\overline{CS}	CLK	\overline{RS}	MSB	\overline{SHDN}	$\overline{LDA/B}$	Serial Shift Register Function	DAC Register Function
H	X	H	X	H	H	No Effect	Latched
L	L	H	X	H	H	No Effect	Latched
L	H	H	X	H	H	No Effect	Latched
L	$\uparrow+$	H	X	H	H	Shift-Register-Data Advanced One Bit	Latched
L	$\uparrow+$	H	X	H	L	Shift-Register-Data Advanced One Bit	Transparent
L	H	H	X	H	L	No Effect	Transparent
$\uparrow+$	L	H	X	H	H	No Effect	Latched
H	X	H	X	H	$\downarrow-$	No Effect	Updated with Current Shift Register Contents
H	X	H	X	H	L	No Effect	Transparent
X	X	L	H	H	X	No Effect	Loaded with 800 _H
X	X	$\uparrow+$	H	H	H	No Effect	Latched with 800 _H
X	X	L	L	H	X	No Effect	Loaded with All Zeros
X	X	$\uparrow+$	L	H	H	No Effect	Latched All Zeros
X	X	X	X	L	X	No Effect	No Affect

NOTES

- $\uparrow+$ positive logic transition; $\downarrow-$ negative logic transition; X Don't Care
- Do not clock in serial data while level sensitive inputs \overline{LDA} or \overline{LDB} are logic LOW.

Table II. AD7394 Serial Input Register Data Format, Data Is Loaded in MSB-First Format

	MSB											LSB
	B11	B10	B9	B8	B7	B6	B5	B4	B3	B2	B1	B0
AD7394	D11	D10	D9	D8	D7	D6	D5	D4	D3	D2	D1	D0

Table III. AD7395 Serial Input Register Data Format, Data Is Loaded in MSB-First Format

	MSB										LSB
	B9	B8	B7	B6	B5	B4	B3	B2	B1	B0	
AD7395	D9	D8	D7	D6	D5	D4	D3	D2	D1	D0	

ABSOLUTE MAXIMUM RATINGS*

V_{DD} to GND	-0.3 V, +7 V
V_{REF} to GND	-0.3 V, V_{DD}
Logic Inputs to GND	-0.3 V, +8 V
V_{OUT} to GND	-0.3 V, $V_{DD} + 0.3$ V
I_{OUT} Short Circuit to GND	50 mA
Package Power Dissipation	$(T_J \text{ max} - T_A)/\theta_{JA}$
Thermal Resistance θ_{JA}	
14-Lead Plastic DIP Package (N-14)	103°C/W
14-Lead SOIC Package (R-14)	158°C/W
14-Lead Thin Shrink Surface Mount (RU-14)	180°C/W
Maximum Junction Temperature ($T_J \text{ max}$)	150°C

Operating Temperature Range	-40°C to +85°C
AD7395AR and AD7395AN Only	-40°C to +125°C
Storage Temperature Range	-65°C to +150°C
Lead Temperature	
N-14 (Soldering, 10 sec)	+300°C
R-14 (Vapor Phase, 60 sec)	+215°C
RU-14 (Infrared, 15 sec)	+224°C

*Stresses above those listed under Absolute Maximum Ratings may cause permanent damage to the device. This is a stress rating only; functional operation of the device at these or any other conditions above those indicated in the operational sections of this specification is not implied. Exposure to absolute maximum rating conditions for extended periods may affect device reliability.

ORDERING GUIDE

Model	Res (LSB)	Temperature Range	Package Description	Package Options
AD7394AN	12	-40°C to +85°C	14-Lead P-DIP	N-14
AD7394AR	12	-40°C to +85°C	14-Lead SOIC	R-14
AD7395AN	10	-40°C to +125°C	14-Lead P-DIP	N-14
AD7395AR	10	-40°C to +125°C	14-Lead SOIC	R-14
AD7395ARU	10	-40°C to +85°C	14-Lead Thin Shrink Small Outline Package (TSSOP)	RU-14

The AD7394/AD7395 contains 709 transistors. The die size measures 70 mil × 99 mil.

CAUTION

ESD (electrostatic discharge) sensitive device. Electrostatic charges as high as 4000 V readily accumulate on the human body and test equipment and can discharge without detection. Although the AD7394/AD7395 features proprietary ESD protection circuitry, permanent damage may occur on devices subjected to high energy electrostatic discharges. Therefore, proper ESD precautions are recommended to avoid performance degradation or loss of functionality.



AD7394/AD7395

PIN FUNCTION DESCRIPTIONS

Pin No.	Name	Function
1	AGND	Analog Ground.
2	V _{OUTA}	DAC A Voltage Output.
3	V _{REF}	DAC Reference voltage input terminal. Establishes DAC full-scale output voltage. Pin can be tied to V _{DD} pin.
4	DGND	Digital Ground. Should be tied to analog GND.
5	\overline{CS}	Chip Select, active low input. Disables shift register loading when high. Does not effect \overline{LDA} or \overline{LDB} operation.
6	CLK	Clock input, positive edge clocks data into shift register, MSB data bit first.
7	SDI	Serial Data Input, input data loads directly into the shift register.
8	\overline{LDA}	Load DAC register strobe, level sensitive active low. Transfers shift register data to DAC A register. Asynchronous active low input. See Control Logic Truth Table for operation.
9	\overline{RS}	Resets DAC register to zero condition or half-scale, depending on MSB pin logic level. Asynchronous active low input.
10	\overline{LDB}	Load DAC register strobe, level-sensitive active low. Transfers shift register data to DAC B register. Asynchronous active low input. See Control Logic Truth Table for operation.
11	MSB	Digital Input: Logic High presets DAC registers to half-scale 800 _H (sets MSB bit to one) when the \overline{RS} pin is strobed; Logic Low clears all DAC registers to zero (000 _H) when the \overline{RS} pin is strobed.
12	\overline{SHDN}	Active low shutdown control input. Does not affect register contents as long as power is present on V _{DD} . New data can be loaded into the shift register and DAC register during shutdown. When device is powered up the most recent data loaded into the DAC register will control the DAC output.
13	V _{DD}	Positive power supply input. Specified range of operation +2.7 V to +5.5 V
14	V _{OUTB}	DAC B Voltage Output.

PIN CONFIGURATIONS

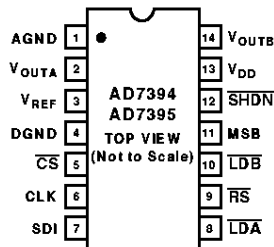

Typical Performance Characteristics— AD7394/AD7395

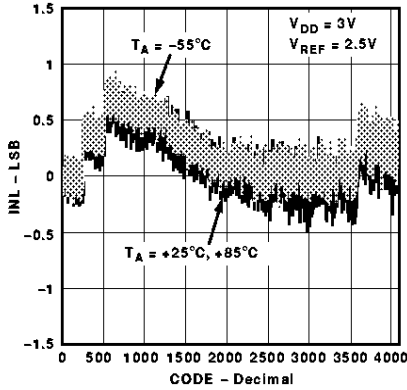

Figure 4. AD7394 Integral Nonlinear Error vs. Code

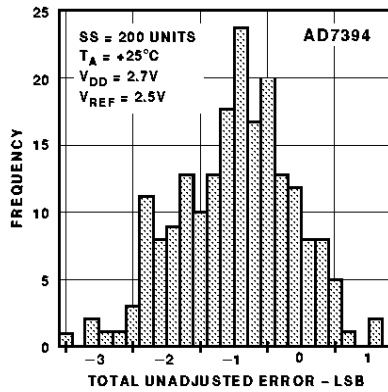

Figure 5. Total Unadjusted Error Histogram

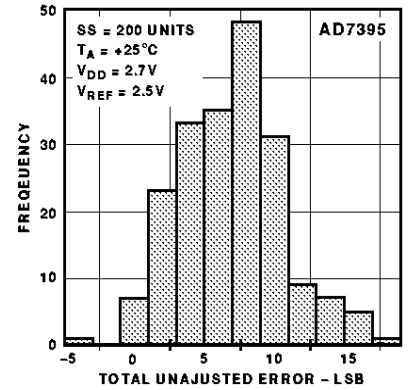

Figure 6. Total Unadjusted Error Histogram

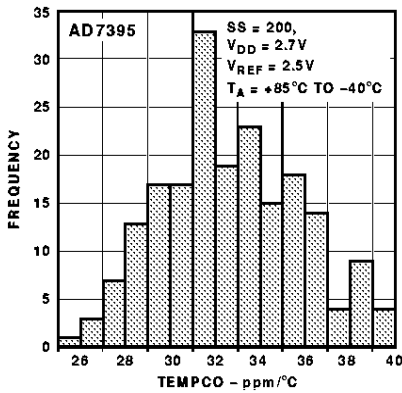

Figure 7. Full-Scale Output Tempco Histogram

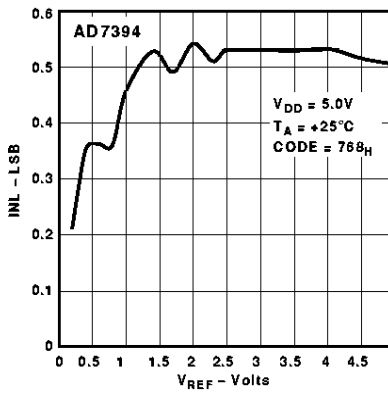

Figure 8. Integral Nonlinearity Error vs. V_{REF}

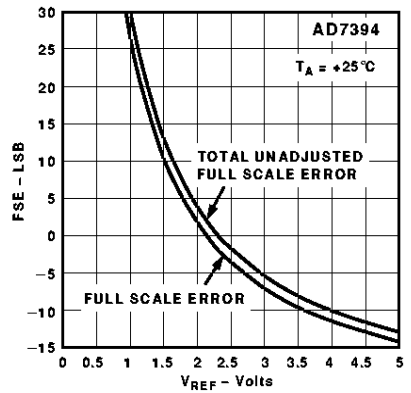

Figure 9. Full-Scale Error vs. V_{REF}

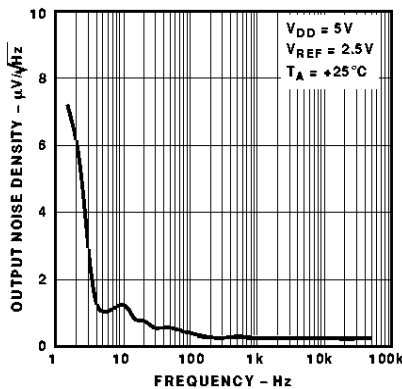

Figure 10. AD7394 Output Noise Density vs. Frequency

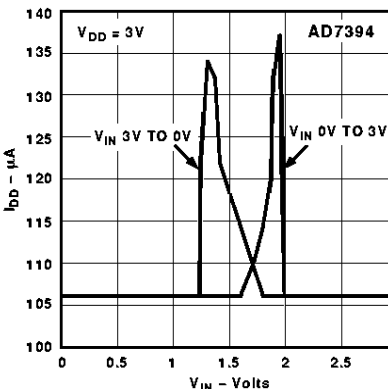

Figure 11. Supply Current vs. Logic Input Voltage

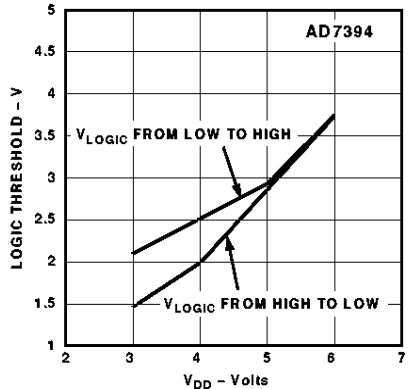

Figure 12. Logic Threshold vs. Supply Voltage

AD7394/AD7395

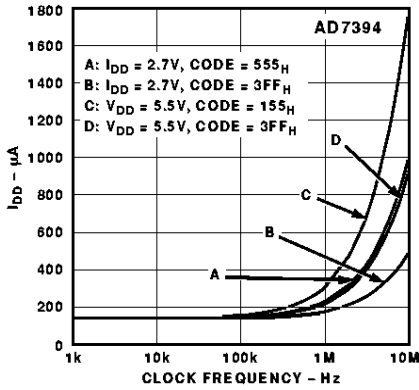

Figure 13. Supply Current vs. Clock Frequency

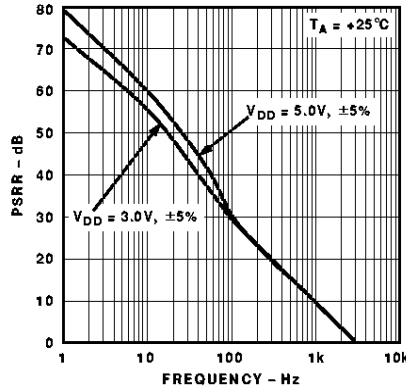

Figure 14. AD7394 Power Supply Rejection vs. Frequency

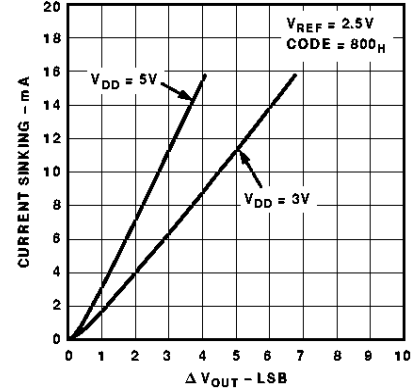

Figure 15. AD7394 I_{OUT} Sink Current vs. ΔV_{OUT}

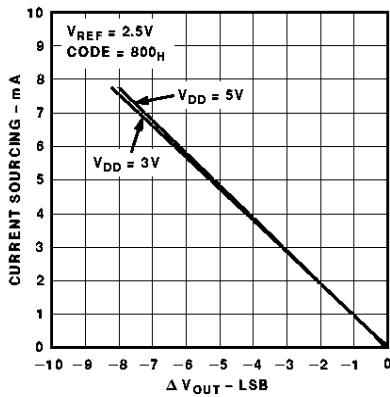

Figure 16. AD7394 I_{OUT} Source Current vs. ΔV_{OUT}

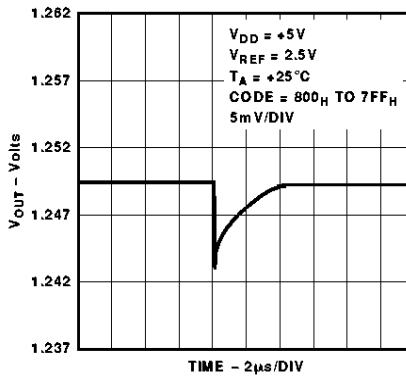

Figure 17. Midscale Transition Performance

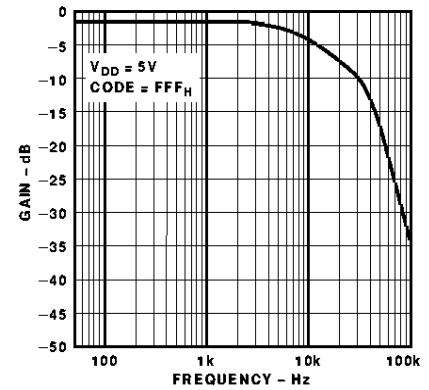

Figure 18. AD7395 Reference Multiplying Bandwidth

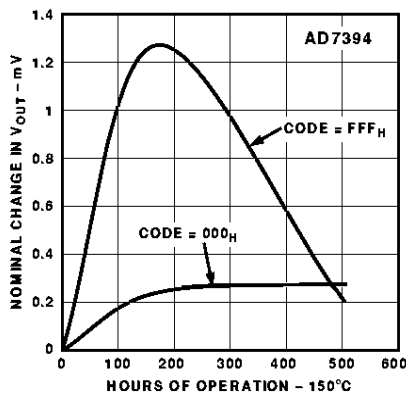

Figure 19. Long-Term Drift Accelerated by Burn-In

OPERATION

The AD7394 and AD7395 are a set of pin compatible, dual, 12-bit/10-bit digital-to-analog converters. These single-supply operation devices consume less than 200 microamps of current while operating from power supplies in the +2.7 V to +5.5 V range, making them ideal for battery operated applications. They contain a voltage-switched, 12-bit/10-bit, laser trimmed digital-to-analog converter, rail-to-rail output op amps, two DAC registers and a serial input shift register. The external reference input has constant input resistance independent of the digital code setting of the DAC. In addition, the reference input can be tied to the same supply voltage as V_{DD} , resulting in a maximum output voltage span of 0 to V_{DD} . The serial interface consists of a serial data input (SDI), clock (CLK) and chip select pin (\overline{CS}) and two load DAC Register pins (\overline{LDA} and \overline{LDB}). A reset (\overline{RS}) pin is available to reset the DAC register to zero scale or midscale, depending on the digital level applied to the MSB pin. This function is useful for power-on reset or system failure recovery to a known state. Additional power savings are accomplished by activating the SHDN pin resulting in a 1.5 μ A maximum consumption sleep mode.

D/A CONVERTER SECTION

The voltage switched R-2R DAC generates an output voltage dependent on the external reference voltage connected to the REF pin according to the following equation:

$$V_{OUT} = \frac{V_{REF} \times D}{2^N} \quad (1)$$

where D is the decimal data word loaded into the DAC register and N is the number of bits of DAC resolution. In the case of the 10-bit AD7395 using a 2.5 V reference, Equation 1 simplifies to:

$$V_{OUT} = \frac{2.5 \times D}{1024} \quad (2)$$

Using Equation 2 the nominal midscale voltage at V_{OUT} is 1.25 V for $D = 512$; full-scale voltage is 2.497 V. The LSB step size is $2.5 \times 1/1024 = 0.0024$ V.

For the 12-bit AD7394 operating from a 5.0 V reference Equation 1 becomes:

$$V_{OUT} = \frac{5.0 \times D}{4096} \quad (3)$$

Using Equation 3 the AD7394 provides a nominal midscale voltage of 2.50 V for $D = 2048$, and a full-scale output of 4.998 V. The LSB step size is $5.0 \times 1/4096 = 0.0012$ V.

AMPLIFIER SECTION

The internal DAC's output is buffered by a low power consumption precision amplifier. The op amp has a 60 μ s typical settling time to 0.1% of full scale. There are slight differences in settling time for negative slewing signals versus positive. Also, negative transition settling time to within the last 6 LSBs of zero volts has an extended settling time. The rail-to-rail output stage of this amplifier has been designed to provide precision performance while operating near either power supply. Figure 20 shows an equivalent output schematic of the rail-to-rail amplifier with its N-channel pull-down FETs that will pull an output load directly to GND. The output sourcing current is provided by a P-channel pull-up device that can source current to GND terminated loads.

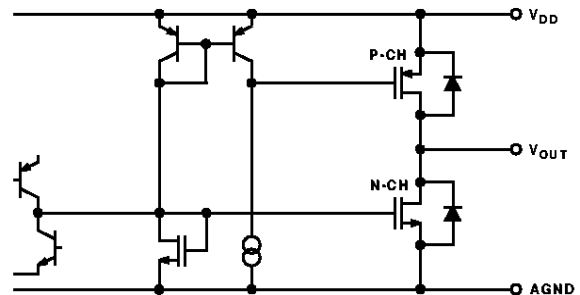

Figure 20. Equivalent Analog Output Circuit

The rail-to-rail output stage provides more than ± 1 mA of output current. The N-channel output pull-down MOSFET shown in Figure 20 has a 35 Ω ON resistance, which sets the sink current capability near ground. In addition to resistive load driving capability, the amplifier has also been carefully designed and characterized for up to 100 pF capacitive load driving capability.

REFERENCE INPUT

The reference input terminal has a constant input resistance independent of digital code which results in reduced glitches on the external reference voltage source. The high 2.5 M Ω input resistance minimizes power dissipation within the AD7394/AD7395 D/A converters. The V_{REF} input accepts input voltages ranging from ground to the positive supply voltage V_{DD} . One of the simplest applications, which saves an external reference voltage source, is connection of the V_{REF} terminal to the positive V_{DD} supply. This connection results in a rail-to-rail voltage output span maximizing the programmed range. The reference input will accept ac signals as long as they are kept within the supply voltage range, $0 < V_{REF} < V_{DD}$. The reference bandwidth and integral nonlinearity error performance are plotted in the Typical Performance Characteristics section (see Figures 8 and 18). The ratiometric reference feature makes the AD7394/AD7395 an ideal companion to ratiometric analog-to-digital converters such as the AD7896.

AD7394/AD7395

POWER SUPPLY

The very low power consumption of the AD7394/AD7395 is a direct result of a circuit design optimizing the use of a CBCMOS process. By using the low power characteristics of CMOS for the logic, and the low noise, tight matching of the complementary bipolar transistors, excellent analog accuracy is achieved. One advantage of the rail-to-rail output amplifiers used in the AD7394/AD7395 is the wide range of usable supply voltage. The part is fully specified and tested for operation from +2.7 V to +5.5 V.

POWER SUPPLY BYPASSING AND GROUNDING

Local supply bypassing consisting of a 10 μ F tantalum electrolytic in parallel with a 0.1 μ F ceramic capacitor is recommended in all applications (Figure 21).

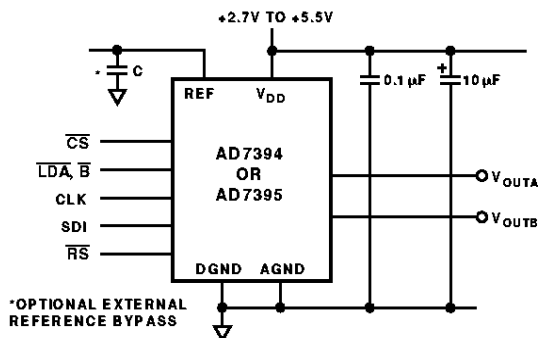

Figure 21. Recommended Supply Bypassing for the AD7394/AD7395

INPUT LOGIC LEVELS

All digital inputs are protected with a Zener-type ESD protection structure (Figure 22) that allows logic input voltages to exceed the V_{DD} supply voltage. This feature can be useful if the user is driving one or more of the digital inputs with a 5 V CMOS logic input-voltage level while operating the AD7394/AD7395 on a +3 V power supply. If this mode of interface is used, make sure that the V_{OL} of the 5 V CMOS meets the V_{IL} input requirement of the AD7394/AD7395 operating at 3 V. See Figure 12 for a graph of digital logic input threshold versus operating V_{DD} supply voltage.

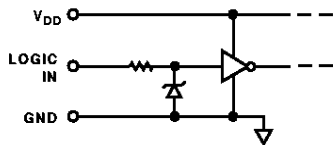

Figure 22. Equivalent Digital Input ESD Protection

In order to minimize power dissipation from input logic levels that are near the V_{IH} and V_{IL} logic input voltage specifications, a Schmitt trigger design was used that minimizes the input-buffer current consumption compared to traditional CMOS input stages. Figure 11 is a plot of incremental input voltage versus supply current showing that negligible current consumption takes place when logic levels are in their quiescent state. The normal crossover current still occurs during logic transitions. A secondary advantage of this Schmitt trigger is the prevention of false triggers that would occur with slow moving

logic transitions when a standard CMOS logic interface or opto isolators are used. The logic inputs SDI, CLK, CS, LDA, LDB, RS, SHDN all contain the Schmitt trigger circuits.

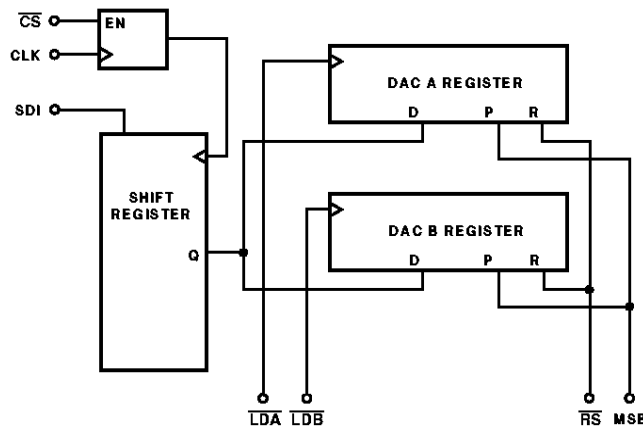

Figure 23. Equivalent Digital Interface Logic

DIGITAL INTERFACE

The AD7394/AD7395 has a serial data input. A functional block diagram of the digital section is shown in Figure 23, while Table I contains the truth table for the logic control inputs. Three pins control the serial data input register loading. Two additional pins determine which DAC will receive the data loaded into the input shift register. Data at the SDI is clocked into the shift register on the rising edge of the CLK. Data is entered in the MSB-first format. The active low chip select (\overline{CS}) pin enables loading of data into the shift register from the SDI pin. Twelve clock pulses are required to load the 12-bit AD7390 DAC shift register. If additional bits are clocked into the shift register, for example, when a microcontroller sends two 8-bit bytes, the MSBs are ignored (Table IV). The lowest resolution AD7395 is also loaded MSB-first with 10 bits of data. Again, if additional bits are clocked into the shift register only the last 10 bits clocked in are used. When \overline{CS} returns to logic high, shift-register loading is disabled. The load pins LDA and LDB control the flow of data from the shift register to the DAC register. After a new value is clocked into the serial-input register, it will be transferred to the DAC register associated with its LDA or LDB logic control line. Note, if the user wants to load both DAC registers with the current contents of the shift register, both control lines LDA and LDB should be strobed together. The LDA and LDB pins are level-sensitive and should be returned to logic high prior to any new data being sent to the input shift register to avoid changing the DAC register values. See Truth Table for complete set of conditions.

RESET (\overline{RS}) PIN

Forcing the asynchronous \overline{RS} pin low will set the DAC register to all zeros, or midscale, depending on the logic level applied to the MSB pin. When the MSB pin is set to logic high, both DAC registers will be reset to midscale (i.e., the DAC Register's MSB bit will be set to Logic 1 followed by all zeros). The reset function is useful for setting the DAC outputs to zero at power-up or after a power supply interruption. Test systems and motor controllers are two of many applications that benefit from powering up to a known state. The external reset pulse can be

Table IV. Typical Microcontroller Interface Formats

MSB		BYTE 1						LSB		MSB		BYTE 0						LSB											
B15	B14	B13	B12	B11	B10	B9	B8	B7	B6	B5	B4	B3	B2	B1	B0	D11	D10	D9	D8	D7	D6	D5	D4	D3	D2	D1	D0		
X	X	X	X	D11	D10	D9	D8	D7	D6	D5	D4	D3	D2	D1	D0	X	X	X	X	D9	D8	D7	D6	D5	D4	D3	D2	D1	D0
X	X	X	X	X	X	X	X	D7	D6	D5	D4	D3	D2	D1	D0	X	X	X	X	D7	D6	D5	D4	D3	D2	D1	D0	D0	

D11–D0: 12-bit AD7394 DAC data; D9–D0: 10-bit AD7395 DAC data; X = Don't Care; The MSB of byte 1 is the first bit that is loaded into the SDI input.

generated by the microprocessor's power-on RESET signal, by an output from the microprocessor, or by an external resistor and capacitor. RESET has a Schmitt trigger input which results in a clean reset function when using external resistor/capacitor generated pulses. See the Control-Logic Truth Table I.

POWER SHUTDOWN ($\overline{\text{SHDN}}$)

Maximum power savings can be achieved by using the power shutdown control function. This hardware activated feature is controlled by the active low input $\overline{\text{SHDN}}$ pin. This pin has a Schmitt trigger input which helps to desensitize it to slowly changing inputs. By placing a logic low on this pin the internal consumption of the device is reduced to nano amp levels, guaranteed to 1.5 μA maximum over the operating temperature range. When the AD7394/AD7395 has been programmed into the power shutdown state, the present DAC register data is maintained as long as V_{DD} remains greater than 2.7 V. Once a wake-up command $\overline{\text{SHDN}} = 1$ is given, the DAC voltage outputs will return to their previous values. It typically takes 80 microseconds for the output voltage to fully stabilize. In the shutdown state the DAC output amplifier exhibits an open-circuit with a nominal output resistance of 500 k Ω to ground. If the power shutdown feature is not needed, then the user should tie the $\overline{\text{SHDN}}$ pin to the V_{DD} voltage thereby disabling this function.

UNIPOLAR OUTPUT OPERATION

This is the basic mode of operation for the AD7394. As shown in Figure 24, the AD7394 has been designed to drive loads as low as 5 k Ω in parallel with 100 pF. The code table for this operation is shown in Table V.

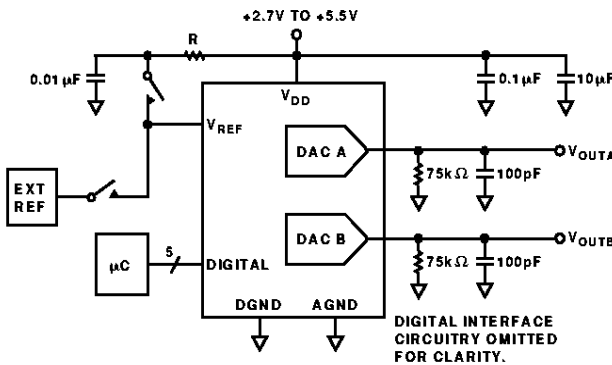

Figure 24. AD7394 Unipolar Output Operation

Table V. Unipolar Code Table

Hexadecimal Number in DAC Register	Decimal Number in DAC Register	Output Voltage (V) [$V_{\text{REF}} = 2.5 \text{ V}$]
FFF	4095	2.4994
801	2049	1.2506
800	2048	1.2500
7FF	2047	1.2494
000	0	0

The circuit can be configured with an external reference plus power supply, or powered from a single dedicated regulator or reference depending on the application performance requirements.

BIPOLAR OUTPUT OPERATION

Although the AD7395 has been designed for single-supply operation, the output can easily be configured for bipolar operation. A typical circuit is shown in Figure 25. This circuit uses a clean regulated +5 V supply for power, which also provides the circuit's reference voltage. Since the AD7395 output span swings from ground to very near +5 V, it is necessary to choose an external amplifier with a common-mode input voltage range that extends to its positive supply rail. The micropower consumption OP196 has been designed just for this purpose and results in only 50 microamps of maximum current consumption. Connection of the equally valued 470 k Ω resistors results in a differential amplifier mode of operation with a voltage gain of two, which produces a circuit output span of ten volts, that is, -5 V to +5 V. As the DAC is programmed from zero code 000_H to mid-scale 200_H to full-scale 3FF_H, the circuit output voltage V_{O} is set at -5 V, 0 V and +5 V (-1 LSB). The output voltage V_{O} is coded in offset binary according to Equation 4.

$$V_{\text{OUT}} = \left[\left(\frac{D}{512} \right) - 1 \right] \times 5 \tag{4}$$

where D is the decimal code loaded in the AD7395 DAC register. Note that the LSB step size is $10/1024 = 10 \text{ mV}$. This circuit has been optimized for micropower consumption including the 470 k Ω gain setting resistors, which should have low temperature coefficients to maintain accuracy and matching (preferably the same resistor material, such as metal film). If better stability is required, the power supply could be substituted with a precision reference voltage such as the low dropout REF195, which can easily supply the circuit's 262 microamps of current, and still provide additional power for the load connected to V_{OUT} . The micropower REF195 is guaranteed to source 10 mA

AD7394/AD7395

output drive current, but consumes only 50 microamps internally. If higher resolution is required, the AD7394 can be used with the addition of two more bits of data inserted into the software coding, which would result in a 2.5 mV LSB step size. Table VI shows examples of nominal output voltages, V_O , provided by the Bipolar Operation circuit application.

Table VI. Bipolar Code Table

Hexadecimal Number in DAC Register	Decimal Number in DAC Register	Analog Output Voltage (V)
3FF	1023	4.9902
201	513	0.0097
200	512	0.0000
1FF	511	-0.0097
000	0	-5.0000

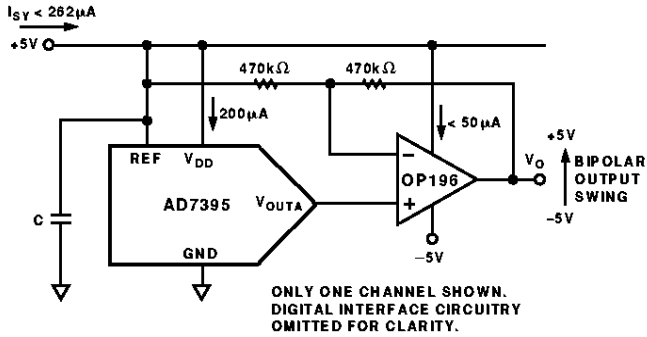
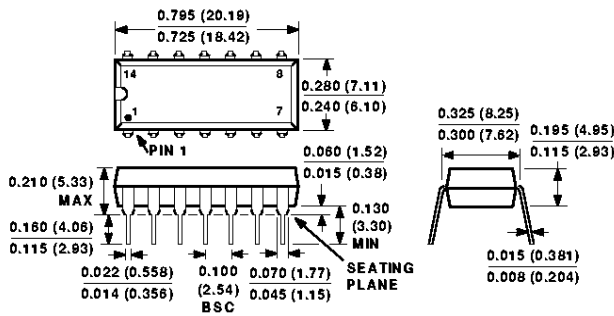

Figure 25. Bipolar Output Operation

OUTLINE DIMENSIONS

Dimensions shown in inches and (mm).

Plastic DIP Package (N-14)



Thin Surface Mount TSSOP Package (RU-14)

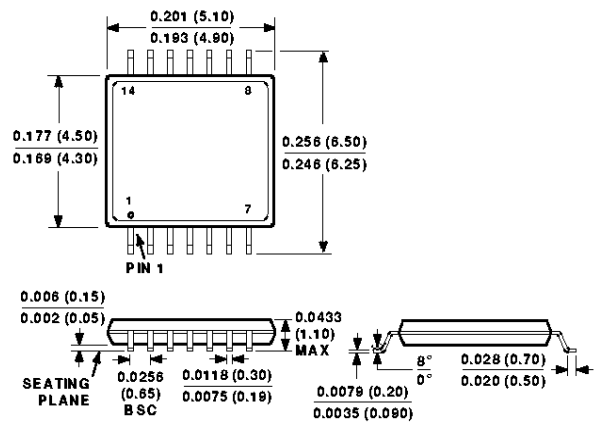

SOIC Package (R-14)

