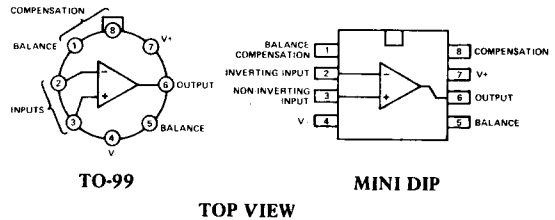

AD101A, AD201A, AD301A, AD301AL

FEATURES

- Low Bias and Offset Current
- Single Capacitor External Compensation for Operating Flexibility
- Nullable Offset Voltage
- No Latch-Up
- Fully Short Circuit Protected
- Wide Operating Voltage Range

AD101 SERIES FUNCTIONAL BLOCK DIAGRAMS

4

GENERAL DESCRIPTION

The Analog Devices AD101A, AD201A, AD301A and AD301AL are high performance monolithic operational amplifiers. All the circuits feature full short circuit protection, external offset voltage nulling, wide operating voltage range, and the total absence or "latch-up". Because frequency compensation is performed externally with a single capacitor (30pF maximum), the AD101A, AD201A, AD301A and AD301AL provide greater flexibility than internally compensated amplifiers since the degree of compensation can be fitted to the specific system application.

The AD101A and AD201A have identical specifications in the TO-99 package; the former guaranteed over the -55°C to $+125^{\circ}\text{C}$ temperature range, and the latter over -25°C to $+85^{\circ}\text{C}$. The AD201A is also available in the mini-DIP package for high performance operation over the 0 to $+70^{\circ}\text{C}$ temperature range. The AD301A is specified for operation over the 0 to $+70^{\circ}\text{C}$ temperature range in both the TO-99 and mini-DIP packages. The AD301AL is the highest accuracy version of this series. Improved processing and additional electrical testing allow the user to achieve precision performance at low cost. The device provides substantially increased accuracy by reducing errors due to offset voltage (0.5mV max), offset voltage drift ($5.0\mu\text{V}/^{\circ}\text{C}$ max), bias current (30nA max), offset current (5nA max), voltage gain (80,000 min), PSRR (90dB min), and CMRR (90dB min). The AD301AL is also specified from 0 to $+70^{\circ}\text{C}$ and is available in the TO-99 can or 8-pin mini-DIP.

SCHEMATIC DIAGRAM

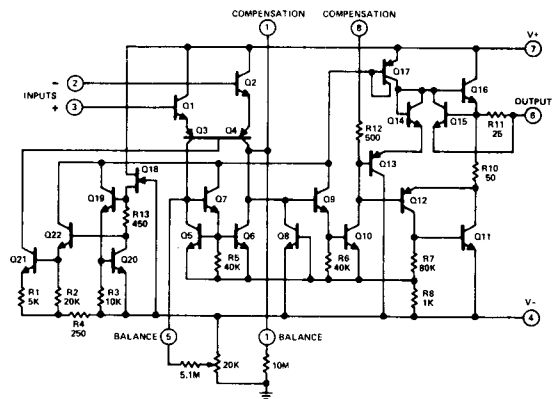

SPECIFICATIONS (typical @ +25°C and ±15V dc, unless otherwise specified)

ABSOLUTE MAXIMUM RATINGS AD101A, AD201A, AD301A, AD301AL unless otherwise specified

Supply Voltage	
AD101A, AD201A	±22V
AD301A, AD301AL	±18V
Power Dissipation ¹	
TO-99 (Metal Can)	500mW
Dual In-Line (Mini-DIP)	500mW
Differential Input Voltage	±30V
Input Voltage ²	±15V
Output Short Circuit Duration ³	Indefinite
Operating Temperature Range	
AD101A	-55°C to +125°C
AD201A (TO-99)	-25°C to +85°C
AD201A (Mini-DIP)	0 to +70°C
AD301A, AD301AL	0 to +70°C
Storage Temperature Range	-65°C to +150°C
Lead Temperature (Soldering, 60sec)	300°C

ELECTRICAL CHARACTERISTICS (T_A = +25°C unless otherwise specified)⁴

Parameter	Conditions	AD101A/AD201A			AD301A			AD301AL			Units
		Min	Typ	Max	Min	Typ	Max	Min	Typ	Max	
Input Offset Voltage	R _S ≤ 50kΩ		0.7	2.0	2.0	7.5		0.3	0.5		mV
Input Offset Current			1.5	10	3	50		3	5		nA
Input Bias Current			30	75	70	250		15	30		nA
Input Resistance		1.5	4		0.5	2	1.5	4			MΩ
Supply Current	V _S = ±20V V _S = ±15V		1.8	3.0		1.8	3.0		1.8	3	mA mA
Large Signal Voltage Gain	V _S = ±15V, V _{OUT} = ±10V, R _L ≥ 2kΩ	50	160		25	160	80	300			V/mV

The Following Specifications Apply Over the Operating Temperature Ranges⁴

Input Offset Voltage	R _S ≤ 10kΩ		3.0		10		0.5				mV
Input Offset Current			20		70		5	10			nA
Average Temp. Coefficient of Input Offset Voltage	T _A (min) ≤ T _A ≤ T _A (max)		3.0	15	6.0	30		2	5		μV/°C
Average Temp. Coefficient of Input Offset Current	+25°C ≤ T _A ≤ T _A (max) T _A (min) ≤ T _A ≤ +25°C		0.01	0.1	0.01	0.3		0.01	0.1		nA/°C nA/°C
Input Bias Current				100		300		30	45		nA
Large Signal Voltage Gain	V _S = ±15V, V _{OUT} = ±10V, R _L ≥ 2kΩ	25			15		40	100			V/mV
Input Voltage Range	V _S = ±20V V _S = ±15V	±15				±12		±12			V V
Common Mode Rejection Ratio	R _S ≤ 50kΩ	80	96		70	90	90	100			dB
Supply Voltage Rejection Ratio	R _S ≤ 50kΩ	80	96		70	96	90	100			dB
Output Voltage Swing	V _S = ±15V, R _L = 10kΩ V _S = ±15V, R _L = 2kΩ	±12	±14		±12	±14	±12	±14			V V
Supply Current	T _A = T _A (max), V _S = ±20V		1.2	2.5				1.8	3		mA

NOTES

¹ The maximum desirable junction temperature of the AD101A is +150°C; that of the AD201A, AD301A and AD301AL is +100°C. For operating at elevated temperatures, devices must be derated based upon a thermal resistance of +150°C/W, junction to ambient, or +45°C/W, junction to case. The thermal resistance of the Dual In-Line package is +160°C/W, junction to ambient.

² For supply voltages less than ±15V, the absolute maximum input voltage is equal to the supply voltage.

³ For the AD301A and AD301AL continuous short circuit is allowed for case temperatures to +70°C and ambient temperatures to +55°C.

⁴ Unless otherwise specified, these specifications apply for supply voltages and ambient temperatures of ±5V to ±20V and -55°C to +125°C for the AD101A, ±5V to ±20V and -25°C to +85°C for the AD201AH (0 to +70°C for the AD201AN), and ±5V to ±15V and 0 to +70°C for the AD301A and AD301AL.

Specifications subject to change without notice.

Applying the IC Operational Amplifier

ORDERING GUIDE

MODEL	TEMP RANGE	ORDER NUMBER*	PACKAGE OPTION**
AD301AL	0 to +70°C	AD301AL	TO-99, N8A
AD201A	-25°C to +85°C	AD201A	TO-99, N8A
AD301A	0 to +70°C	AD301A	TO-99, N8A
AD101A	-55°C to +125°C	AD101AH	TO-99

*Add package type letter: H = TO-99, N = Mini DIP.
 **See Section 19 for package outline information.

FREQUENCY COMPENSATION CIRCUITS

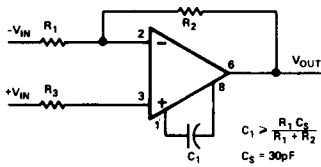

Figure 1. Single Pole Compensation

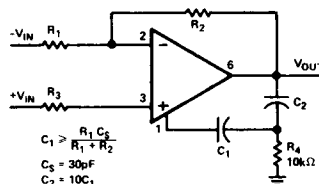

Figure 2. Two Pole Compensation

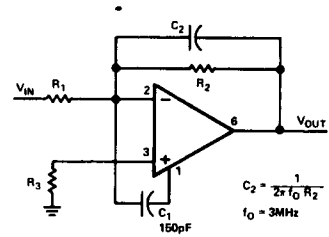
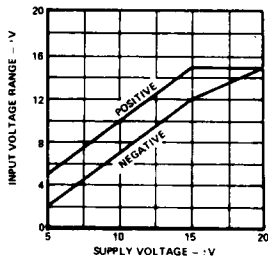

Figure 3. Feedforward Compensation

GUARANTEED PERFORMANCE CURVES

(Curves apply over the Operating Temperature Ranges)



Input Voltage Range

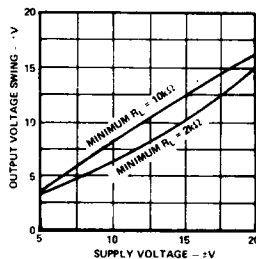

Output Swing

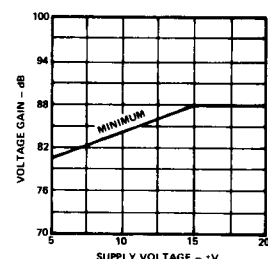

Voltage Gain

TYPICAL PERFORMANCE CURVES⁴

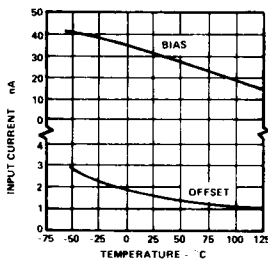

Input Current AD101A, AD201A

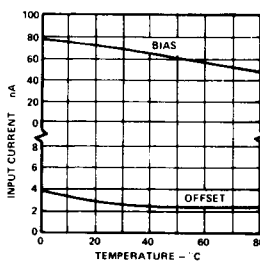

Input Current - AD301A

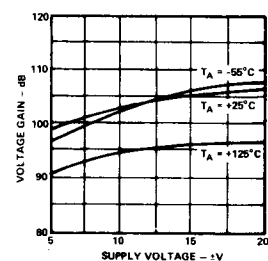

Voltage Gain

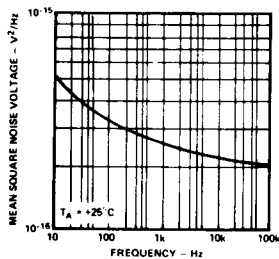

Input Noise Voltage

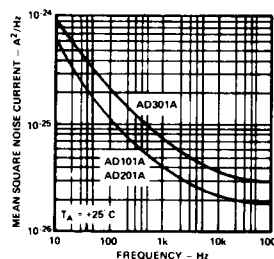

Input Noise Current

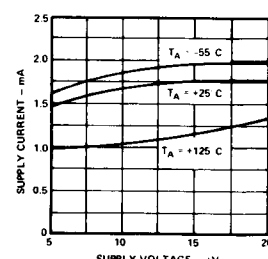

Supply Current

TYPICAL PERFORMANCE CURVES

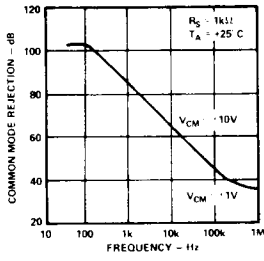

Common Mode Rejection

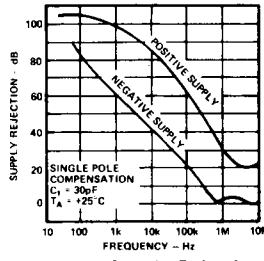

Power Supply Rejection

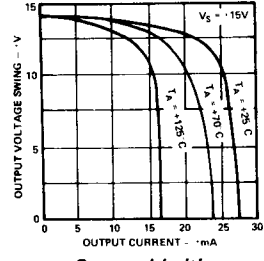

Current Limiting

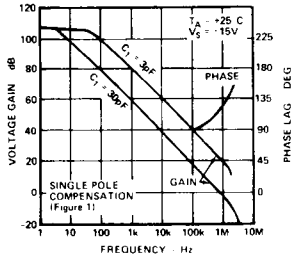

Open Loop Frequency Response

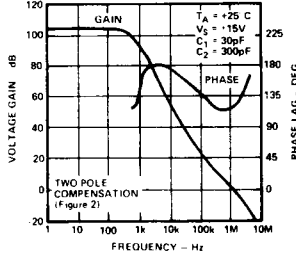

Open Loop Frequency Response

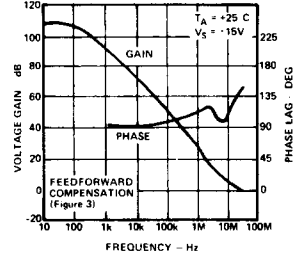

Open Loop Frequency Response

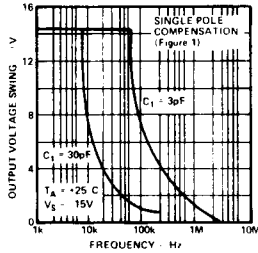

Large Signal Frequency Response

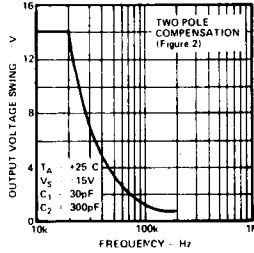

Large Signal Frequency Response

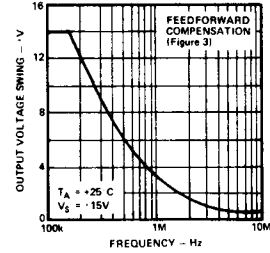

Large Signal Frequency Response

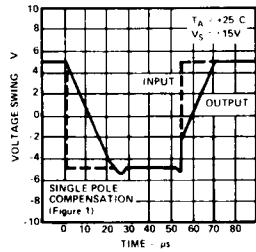

Voltage Follower Pulse Response

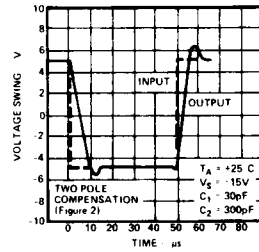

Voltage Follower Pulse Response

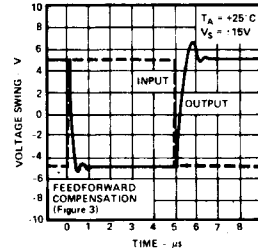

Inverter Pulse Response