

FEATURES

- Programmable Supply Current 500nA to 400 μ A
- Single Supply Operation +3V to +30V
- Dual Supply Operation $\pm 1.5V$ to $\pm 15V$
- Low Input Offset Voltage 100 μ V
- Low Input Offset Voltage Drift 0.75 μ V/ $^{\circ}$ C
- High Common-Mode Input Range $V-$ to $V+$ ($-1.5V$)
- High CMRR and PSRR 115dB
- High Open-Loop Gain 1800V/mV
- $\pm 30V$ Input Overvoltage Protection
- Unity-Gain Stable
- LM4250 Pinout and Nulling
- Available in Die/Form

GENERAL DESCRIPTION

The OP-22 is a monolithic micropower operational amplifier designed to provide excellent accuracy in high-gain applications. Offsets are very low which generally eliminates any need for external nulling of V_{OS} . The OP-22 is internally compensated and unity-gain stable. It also features high open-loop gain, CMRR, and PSRR. This assures good gain accuracy and rejection of power supply variations even when

used in circuits with high closed-loop gain. The low offsets and high gain accuracy of the OP-22 bring precision performance to the micropower field.

The OP-22 is a versatile op amp designed for operation from battery or solar-cell power sources. Supply current is programmable over a range of 500nA to 400 μ A with a single external resistor. Input voltage range is very wide and extends down to the negative rail, thus the common-mode input voltage range includes ground when operating from a single supply voltage. This ability to provide high DC performance over a wide input range is particularly useful in single-battery applications. In addition, the OP-22 is characterized over a wide supply range of $\pm 1.5V$ to $\pm 15V$, or +3V to +30V for single supply.

The OP-22 pin-out and offset nulling are identical to the LM4250 and many other micropower operational amplifiers. This functional commonality allows easy upgrading of system performance. By selection of set resistor value, the circuit designer can readily use the OP-22 in place of such amplifiers as the LM108, LM112, LM4250, $\mu A776$, and ICL8021 in high-gain, low-frequency applications.

SIMPLIFIED SCHEMATIC

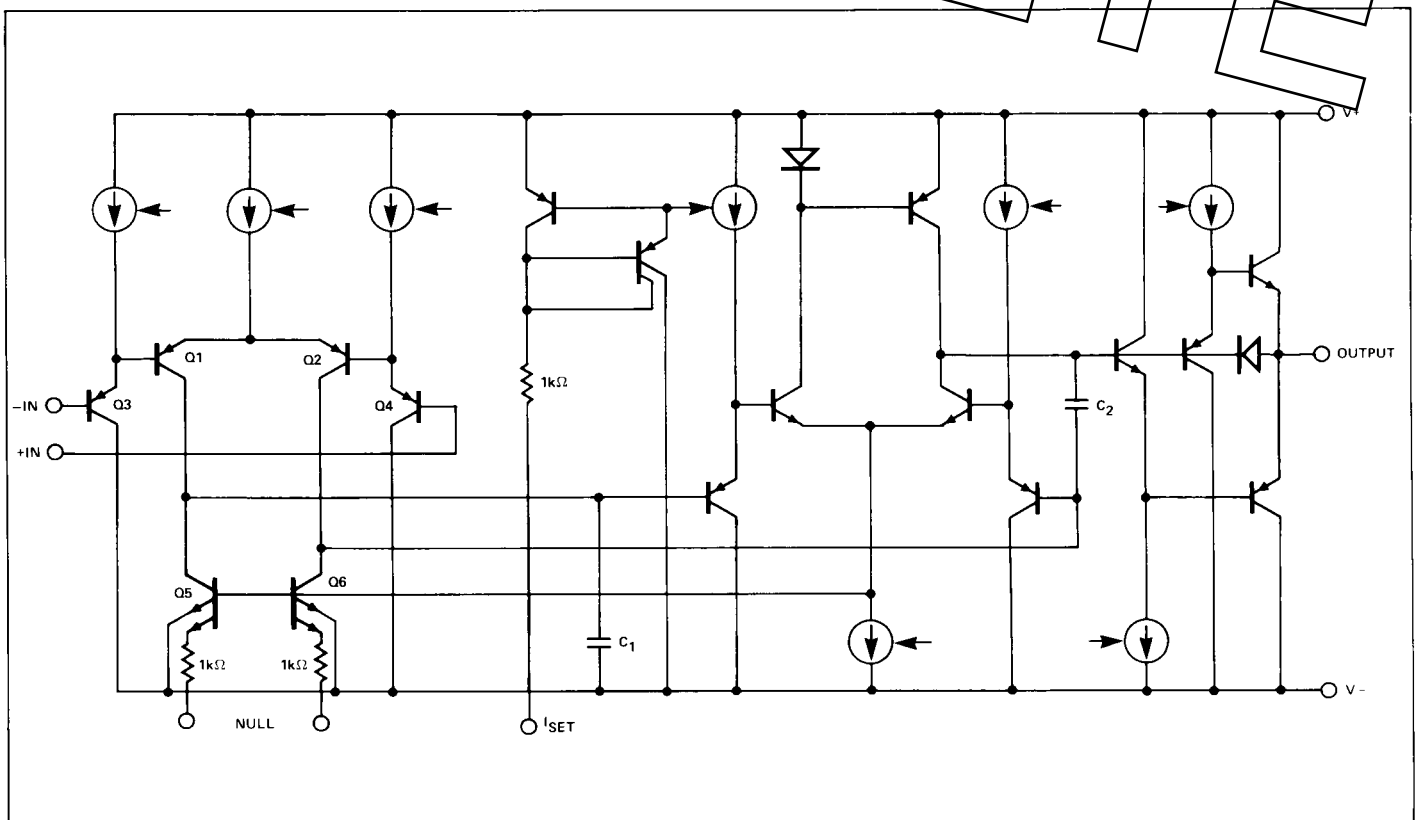

OP-22

ABSOLUTE MAXIMUM RATINGS (Note 1)

Supply Voltage	±18V
Differential Input Voltage	±30V
Input Voltage	Supply Voltage
Storage Temperature Range	
J and Z Packages	-65°C to +150°C
Operating Temperature Range	
OP-22A	-55°C to +125°C
OP-22E, OP-22F	-25°C to +85°C
OP-22H	-40°C to +85°C
Lead Temperature Range (Soldering, 60 sec)	+300°C
Junction Temperature	-65°C to +150°C

PACKAGE TYPE	θ_{JA} (Note 2)	θ_{JC}	UNITS
TO-99 (J)	150	18	°C/W
8-Pin Hermetic DIP (Z)	148	16	°C/W
8-Pin Plastic DIP (P)	103	43	°C/W
8-Pin SO (S)	158	43	°C/W

NOTES:

1. Absolute maximum ratings apply to both DICE and packaged parts, unless otherwise noted.
2. θ_{JA} is specified for worst case mounting conditions, i.e., θ_{JA} is specified for device in socket for TO, CerDIP and P-DIP packages; θ_{JA} is specified for device soldered to printed circuit board for SO package.

ELECTRICAL CHARACTERISTICS at $V_S = \pm 1.5V$ to $\pm 15V$, $1\mu A \leq I_{SET} \leq 10\mu A$, $T_A = +25^\circ C$, unless otherwise noted.

PARAMETER	SYMBOL	CONDITIONS	OP-22A/E			OP-22F			OP-22H			UNITS
			MIN	TYP	MAX	MIN	TYP	MAX	MIN	TYP	MAX	
Input Offset Voltage	V_{OS}		—	100	300	—	200	500	—	400	1000	μV
Input Offset Current	I_{OS}	$V_{CM} = 0$	—	0.2	1	—	0.3	2	—	0.5	3	nA
Input Bias Current	I_B	$I_{SET} = 1\mu A, V_{CM} = 0$	—	2.6	5	—	3.0	7.5	—	4.0	10	nA
		$I_{SET} = 10\mu A, V_{CM} = 0$	—	19	30	—	24	35	—	30	50	
Input Voltage Range	IVR	$V_+ = +5V,$ $V_- = 0V,$ $V_S = \pm 15V$	0/3.5	—	—	0/3.5	—	—	0/3.5	—	—	V
			-15/+13.5	—	—	-15/+13.5	—	—	-15/+13.5	—	—	
Common-Mode Rejection Ratio	CMRR (Note 2)	$V_S = \pm 15V$ $-15V \leq V_{CM} \leq +13.5V$	100	115	—	95	105	—	85	95	—	dB
Power Supply Rejection Ratio (Note 1)	PSRR (Note 2)	$V_S = \pm 1.5V$ to $\pm 15V$; and $V_- = 0V,$ $V_+ = 3V$ to $30V.$	—	1.8	6	—	6	18	—	10	32	$\mu V/V$
Large-Signal Voltage Gain	A_{VO}	$V_S = \pm 15V,$ $I_{SET} = 1\mu A,$ $R_L = 100k\Omega.$	1000	1800	—	500	900	—	250	500	—	V/mV
		$V_S = \pm 15V,$ $I_{SET} = 10\mu A,$ $R_L = 10k\Omega.$	1000	1800	—	500	900	—	300	500	—	V/mV
Output Voltage Swing	V_O	$V_S = \pm 1.5V,$ $I_{SET} = 1\mu A, R_L = 100k\Omega$ & $I_{SET} = 10\mu A, R_L = 10k\Omega.$	±0.8	±0.82	—	±0.8	±0.82	—	±0.75	±0.8	—	V
		$V_S = \pm 15V,$ $I_{SET} = 1\mu A, R_L = 100k\Omega$ & $I_{SET} = 10\mu A, R_L = 10k\Omega.$	±14	±14.2	—	±14	±14.2	—	±13.5	±14	—	V
Closed-Loop Bandwidth	BW	$A_{VCL} = +1.0,$ $V_S = \pm 15V,$ $I_{SET} = 10\mu A, R_L = 10k\Omega.$	—	250	—	—	250	—	—	250	—	kHz
Slew Rate	SR	$V_S = \pm 15V,$ $I_{SET} = 10\mu A,$ $R_L = 10k\Omega.$	—	0.08	—	—	0.08	—	—	0.08	—	V/ μs
Supply Current	I_{SY}	$V_S = \pm 15V, I_{SET} = 1\mu A.$	—	15	17	—	16	19	—	18	21	μA
		$V_S = \pm 15V, I_{SET} = 10\mu A.$	—	150	170	—	160	190	—	180	210	
		$V_S = \pm 1.5V, I_{SET} = 1\mu A.$	—	10.5	12.5	—	14	16	—	17	20	μA
No Load		$V_S = \pm 1.5V, I_{SET} = 10\mu A.$	—	105	125	—	140	160	—	170	200	μA

NOTES:

1. Sample tested for single-supply operation, 100% tested for dual-supply operation.
2. Measured with V_{OS} unnullled and I_{SET} constant.

ELECTRICAL CHARACTERISTICS at $V_S = \pm 1.5V$ to $\pm 15V$, $1\mu A \leq I_{SET} \leq 10\mu A$, $-55^\circ C \leq T_A \leq +125^\circ C$ for OP-22A, $-25^\circ C \leq T_A \leq +85^\circ C$ for OP-22E/F, and $-40^\circ C \leq T_A \leq +85^\circ C$ for OP-22H, unless otherwise noted.

PARAMETER	SYMBOL	CONDITIONS	OP-22A/E			OP-22F			OP-22H			UNITS
			MIN	TYP	MAX	MIN	TYP	MAX	MIN	TYP	MAX	
Average Input Offset Voltage Drift (Note 1)	TCV_{OS}	Unnulled	—	0.75	1.5	—	1.0	2.0	—	1.5	3.0	$\mu V/^\circ C$
Input Offset Voltage	V_{OS}		—	175	400	—	350	600	—	500	1200	μV
Input Offset Current	I_{OS}	$V_{CM} = 0$	—	0.2	1	—	0.3	2	—	0.5	3	nA
Average Input Offset Current Drift	TCI_{OS}	(Note 1)	—	2	10	—	3	15	—	5	25	$pA/^\circ C$
Input Bias Current	I_B	$I_{SET} = 1\mu A, V_{CM} = 0$ $I_{SET} = 10\mu A, V_{CM} = 0$	—	2.8	5	—	3.3	7.5	—	4.5	10	nA
Input Voltage Range	IVR	$V_+ = +5V, V_- = 0V$ $V_S = \pm 15V$	0/3.2	—	—	0/3.2	—	—	0/3.2	—	—	V
Common-Mode Rejection Ratio	$CMRR$ (Note 3)	$V_S = \pm 15V$ $-15V \leq V_{CM} \leq +13.2V$ $I_{SET} = 1\mu A$ $I_{SET} = 10\mu A$	80 90	105 115	—	80 86	99 105	—	80 80	90 90	—	dB
Power Supply Rejection Ratio	$PSRR$ (Note 3)	$V_S = \pm 1.5V$ to $\pm 15V$ & $V_- = 0V$, $V_+ = 3V$ to $30V$ (Note 2)	—	3.2	10	—	10	32	—	32	56	$\mu V/V$
Large-Signal Voltage Gain	A_{VO}	$V_S = \pm 15V$, $I_{SET} = 1\mu A, R_L = 100k\Omega$. $V_S = \pm 15V$, $I_{SET} = 10\mu A, R_L = 10k\Omega$.	200 500	400 1000	—	200 300	400 750	—	100 150	250 300	—	V/mV
Output Voltage Swing	V_O	$V_S = \pm 1.5V$, $I_{SET} = 1\mu A, R_L = 100k\Omega$ & $I_{SET} = 10\mu A, R_L = 10k\Omega$. $V_S = \pm 15V$, $I_{SET} = 1\mu A, R_L = 100k\Omega$ & $I_{SET} = 10\mu A, R_L = 10k\Omega$.	± 0.65 ± 13.6	± 0.75 ± 13.8	—	± 0.65 ± 13.6	± 0.75 ± 13.8	—	± 0.6 ± 13.0	± 0.7 ± 13.5	—	V
Supply Current No Load	I_{SY}	$V_S = \pm 15V, I_{SET} = 1\mu A$. $V_S = \pm 15V, I_{SET} = 10\mu A$. $V_S = \pm 1.5V, I_{SET} = 1\mu A$. $V_S = \pm 1.5V, I_{SET} = 10\mu A$.	— — — —	16 160 12 120	18 180 14 140	— — — —	17 170 15 150	20 200 18 180	— — — —	20 200 19 190	25 250 25 250	μA

NOTES:

- Sample tested.
- $V_{CM} = 1.5V$
- Measured with V_{OS} unnulled and I_{SET} constant.

ORDERING INFORMATION †

$T_A = +25^\circ C$ $V_{OS} \text{ MAX}$ (μV)	PACKAGE			OPERATING TEMPERATURE RANGE
	TO-99	CERDIP 8-PIN	PLASTIC 8-PIN	
300	OP22AJ/883	OP22AZ*	—	MIL
300	—	OP22EZ	—	IND
500	—	OP22FZ	—	IND
1000	—	OP22HZ	OP22HP	XIND
1000	—	—	OP22HS	XIND

* For devices processed in total compliance to MIL-STD-883, add /883 after part number. Consult factory for 883 data sheet.

† Burn-in is available on commercial and industrial temperature range parts in CerDIP, plastic DIP, and TO-can packages.

PIN CONNECTIONS

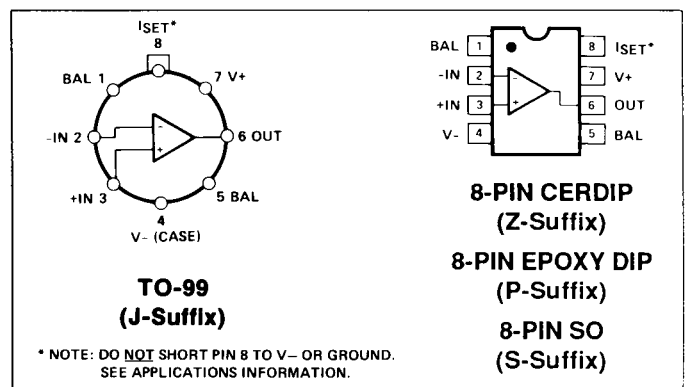

OP-22

DICE CHARACTERISTICS

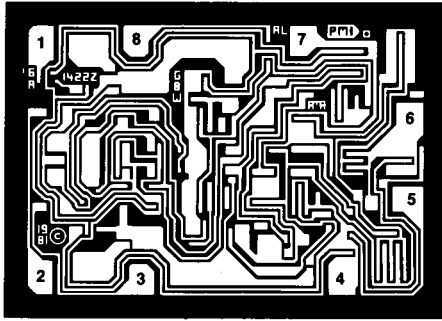

1. BALANCE
2. INVERTING INPUT
3. NONINVERTING INPUT
4. V-
5. BALANCE
6. OUTPUT
7. V+
8. ISET

DIE SIZE 0.070 × 0.050 inch, 3500 sq. mils
(1.78 × 1.27 mm, 2.26 sq. mm)

WAFER TEST LIMITS at $V_S = \pm 1.5V$ to $\pm 15V$, $1\mu A \leq I_{SET} \leq 10\mu A$, $T_A = 25^\circ C$, unless otherwise noted.

PARAMETER	SYMBOL	CONDITIONS	OP-22N LIMIT	OP-22G LIMIT	OP-22GR LIMIT	UNITS
Input Offset Voltage	V_{OS}		300	500	1000	μV MAX
Input Offset Current	I_{OS}	(Note 1)	1	2	3	nA MAX
Input Bias Current	I_B	$I_{SET} = 1\mu A$ $I_{SET} = 10\mu A$ (Note 1)	5 30	7.5 35	10 50	nA MAX
Input Voltage Range	IVR	$V_+ = +5V, V_- = 0V$ $V_S = \pm 15V$	0/3.5 -15/+13.5	0/3.5 -15/+13.5	0/3.5 -15/+13.5	V MIN
Common-Mode Rejection Ratio	CMRR	$V_S = \pm 15V, -15V \leq V_{CM} \leq +13.5V$ (Note 2)	100	95	85	dB MIN
Power Supply Rejection Ratio	PSRR	$V_S = \pm 1.5V$ to $\pm 15V$ $V_- = 0V, V_+ = 3V$ to $30V$ (Note 2)	6	18	32	$\Delta V/V$ MIN
Large-Signal Voltage Gain	A_{VO}	$V_S = \pm 15V,$ $I_{SET} = 1\mu A, R_L = 100k\Omega.$	1000	500	250	V/mV MIN
		$V_S = \pm 15V,$ $I_{SET} = 10\mu A, R_L = 10k\Omega.$	1000	500	300	V/mV MIN
Output Voltage Swing	V_O	$V_S = \pm 1.5V,$ $I_{SET} = 1\mu A, R_L = 100k\Omega$ & $I_{SET} = 10\mu A, R_L = 10k\Omega.$	± 0.8	± 0.8	± 0.75	V MIN
		$V_S = \pm 15V,$ $I_{SET} = 1\mu A, R_L = 100k\Omega$ & $I_{SET} = 10\mu A, R_L = 10k\Omega.$	± 14	± 14	± 13.5	V MIN
Supply Current No Load	I_{SY}	$V_S = \pm 15V, I_{SET} = 1\mu A.$	17	19	21	μA MAX
		$V_S = \pm 15V, I_{SET} = 10\mu A.$	170	190	210	μA MAX
		$V_S = \pm 1.5V, I_{SET} = 1\mu A.$ $V_S = \pm 1.5V, I_{SET} = 10\mu A.$	12.5 125	16 160	20 200	μA MAX

NOTES:

1. $V_{CM} = 0$
2. Measured with V_{OS} unnullled and I_{SET} held constant.

Electrical tests are performed at wafer probe to the limits shown. Due to variations in assembly methods and normal yield loss, yield after packaging is not guaranteed for standard product dice. Consult factory to negotiate specifications based on dice lot qualification through sample lot assembly and testing.

TYPICAL ELECTRICAL CHARACTERISTICS at $V_S = \pm 1.5V$ to $\pm 15V$, $1\mu A \leq I_{SET} \leq 10\mu A$, $T_A = +25^\circ C$, unless otherwise noted.

PARAMETER	SYMBOL	CONDITIONS	OP-22N TYPICAL	OP-22G TYPICAL	OP-22GR TYPICAL	UNITS
Average Input Offset Voltage Drift	TCV_{OS}	Unnullled	1.0	1.5	2.5	$\mu V/^\circ C$
Large-Signal Voltage Gain	A_{VO}	$V_S = \pm 15V$ $I_{SET} = 1\mu A, R_L = 100k\Omega$ & $I_{SET} = 10\mu A, R_L = 10k\Omega$	1800	900	500	V/mV

TYPICAL PERFORMANCE CHARACTERISTICS

SUPPLY CURRENT vs SET RESISTOR

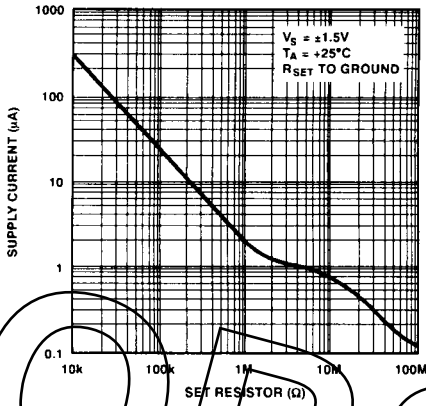

SET CURRENT vs SET RESISTOR

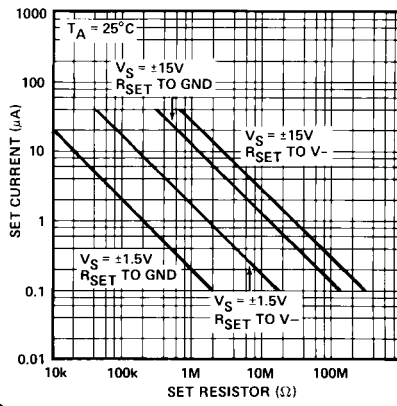

SUPPLY CURRENT vs SET CURRENT

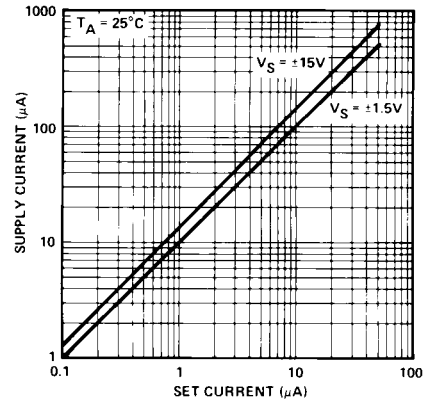

BIAS CURRENT vs SET CURRENT

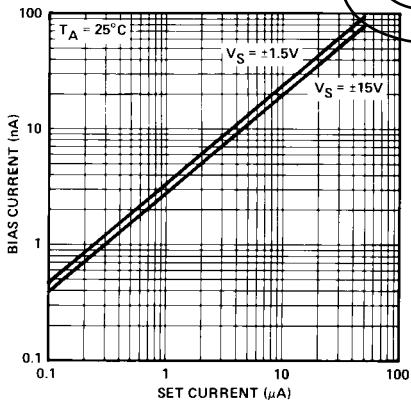

OFFSET CURRENT vs SET CURRENT

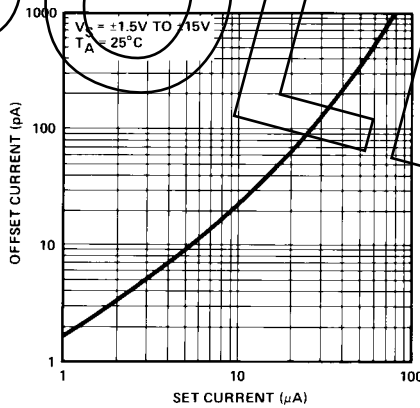

OFFSET VOLTAGE vs SET CURRENT

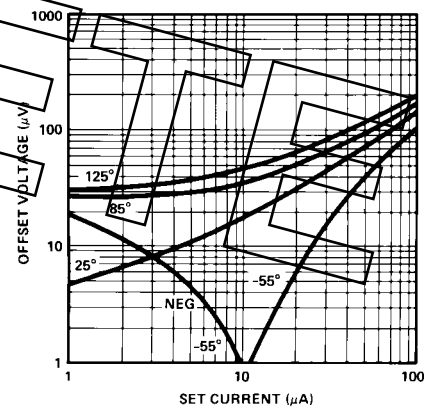

OP-22

TYPICAL PERFORMANCE CHARACTERISTICS *Continued*

POWER SUPPLY REJECTION vs SET CURRENT

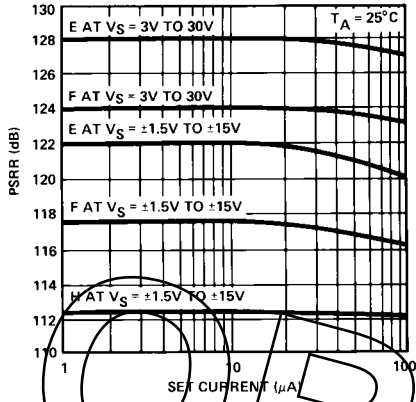

COMMON-MODE REJECTION vs SET CURRENT

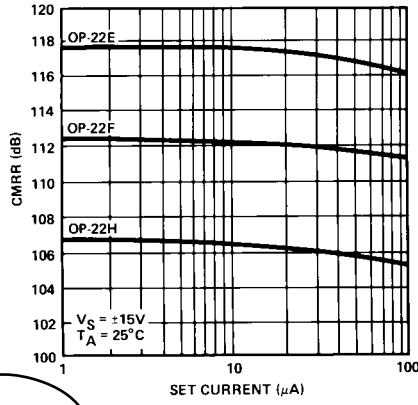

PHASE MARGIN vs SET CURRENT

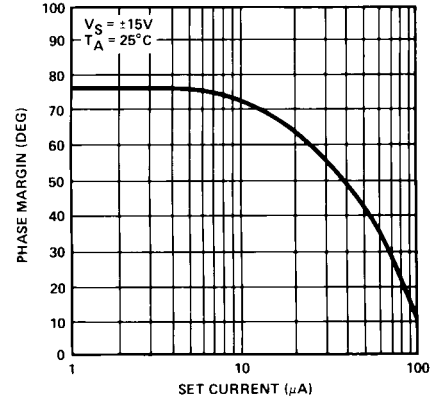

SLEW RATE vs SET CURRENT

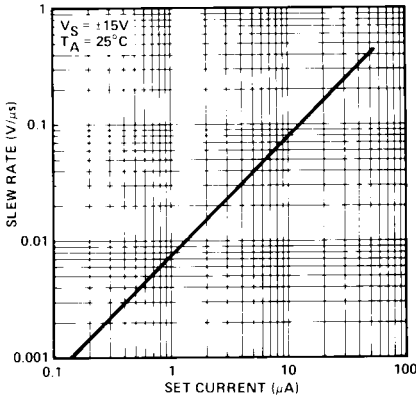

GAIN-BANDWIDTH PRODUCT vs SET CURRENT

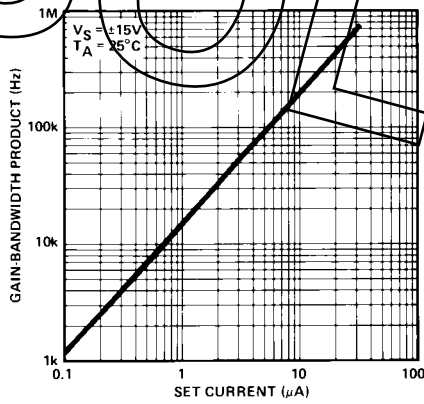

OPEN-LOOP GAIN vs SET CURRENT

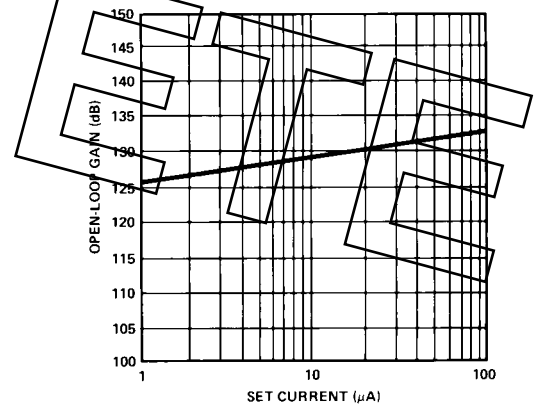

TYPICAL PERFORMANCE CHARACTERISTICS *Continued*

FREQUENCY RESPONSE vs SET CURRENT

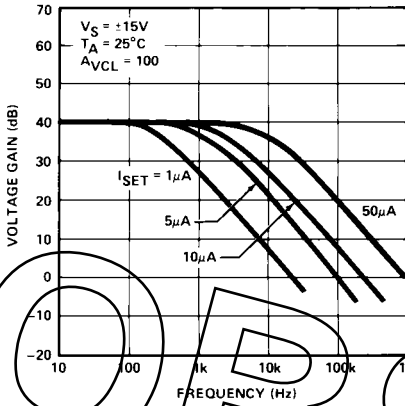

CLOSED-LOOP FREQUENCY RESPONSE

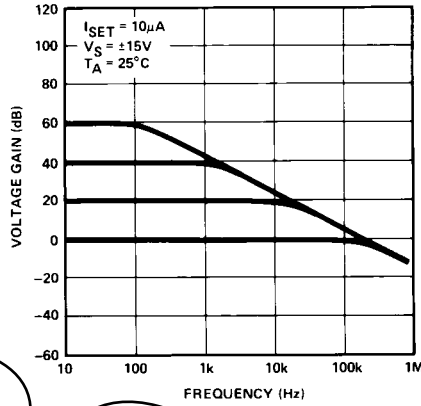

POWER SUPPLY REJECTION vs FREQUENCY

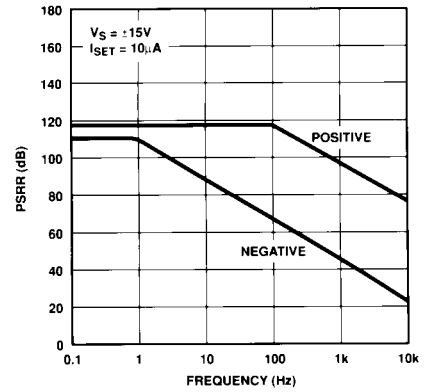

COMMON-MODE REJECTION vs FREQUENCY

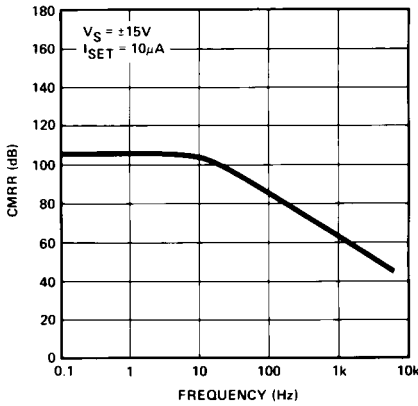

PEAK-TO-PEAK OUTPUT SWING vs LOAD RESISTANCE

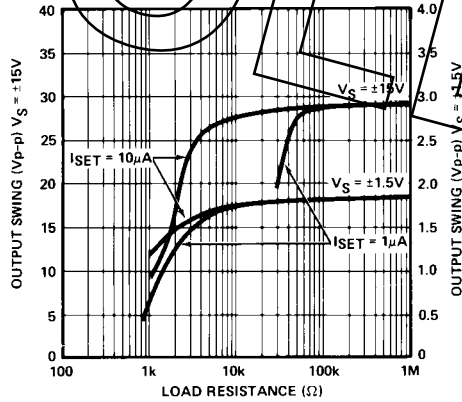

MAXIMUM OUTPUT CURRENT vs SET CURRENT AT VS = ±15V, +5V and ±1.5V

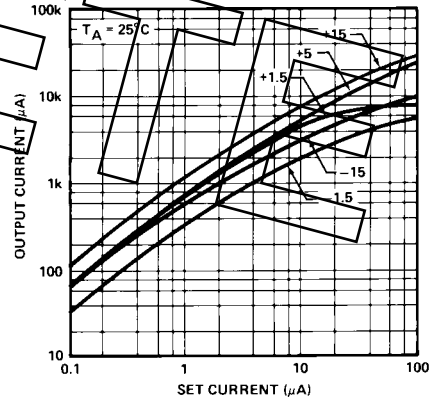

VOLTAGE NOISE vs FREQUENCY

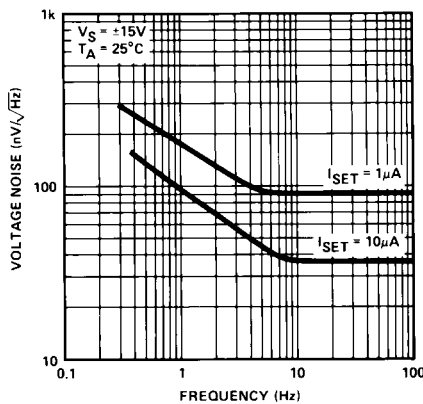

OP-22

TYPICAL PERFORMANCE CHARACTERISTICS *Continued*

CURRENT NOISE vs FREQUENCY

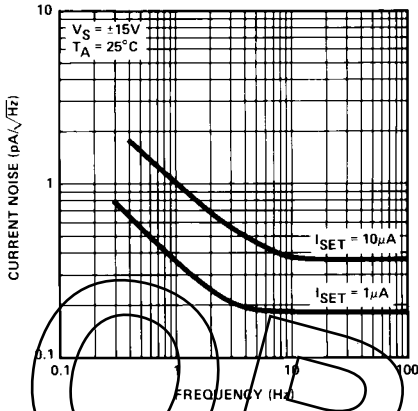

SUPPLY CURRENT vs TEMPERATURE

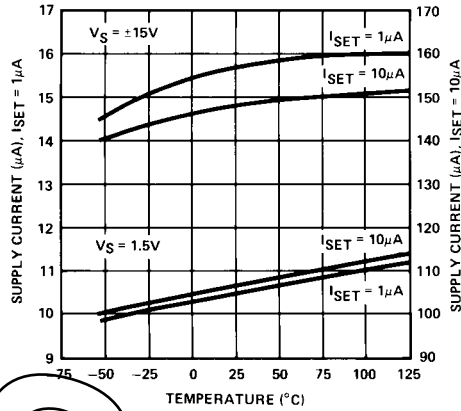

BIAS CURRENT vs TEMPERATURE

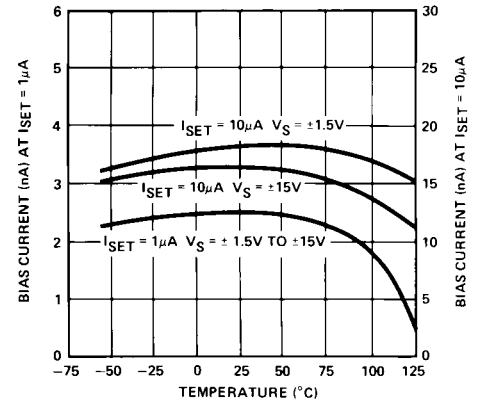

OFFSET CURRENT vs TEMPERATURE

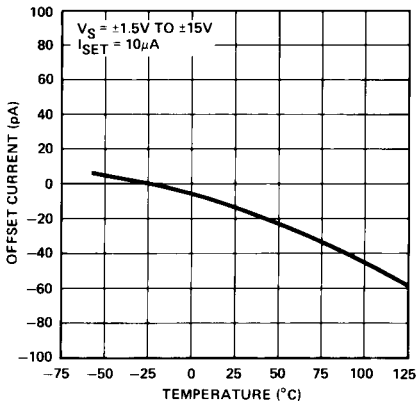

OPEN-LOOP GAIN vs TEMPERATURE

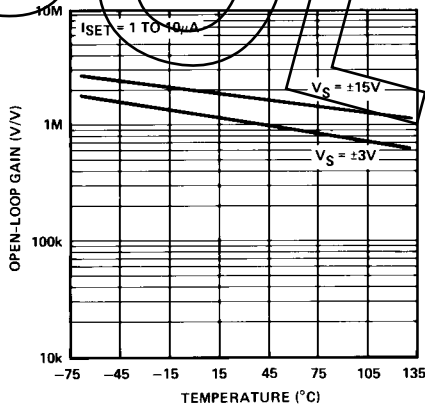

SMALL-SIGNAL TRANSIENT RESPONSE

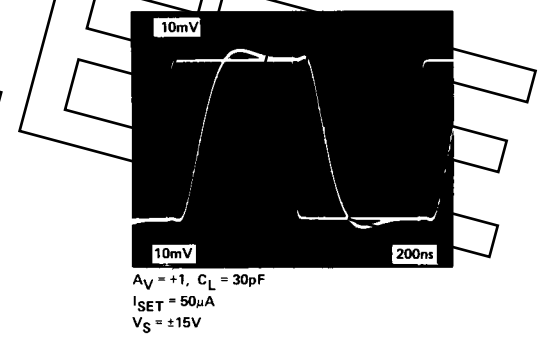

SMALL-SIGNAL TRANSIENT RESPONSE

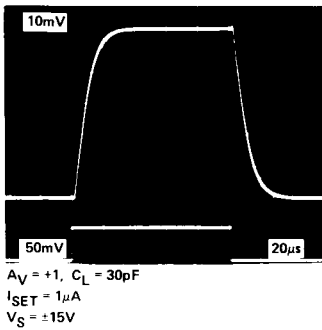

SMALL-SIGNAL TRANSIENT RESPONSE

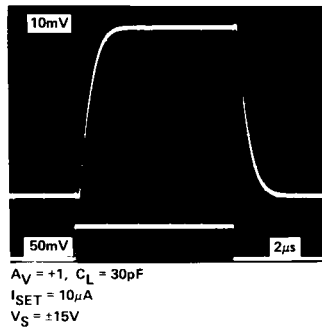

SMALL-SIGNAL TRANSIENT RESPONSE

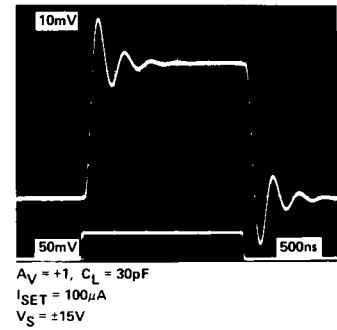

TYPICAL PERFORMANCE CHARACTERISTICS *Continued*

**SMALL-SIGNAL
TRANSIENT RESPONSE**

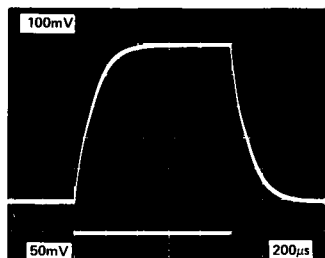

$A_V = +10$, $C_L = 30\text{pF}$
 $I_{SET} = 1\mu\text{A}$
 $V_S = \pm 15\text{V}$

**SMALL-SIGNAL
TRANSIENT RESPONSE**

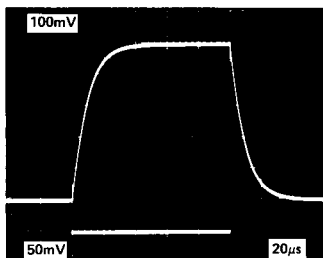

$A_V = +10$, $C_L = 30\text{pF}$
 $I_{SET} = 10\mu\text{A}$
 $V_S = \pm 15\text{V}$

**SMALL-SIGNAL
TRANSIENT RESPONSE**

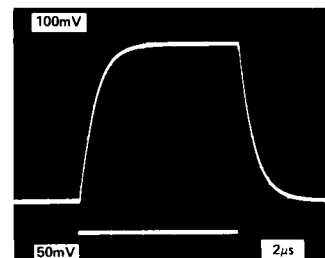

$A_V = +10$, $C_L = 30\text{pF}$
 $I_{SET} = 100\mu\text{A}$
 $V_S = \pm 15\text{V}$

APPLICATIONS INFORMATION

OP-22 series units may be inserted directly into LM4250, $\mu\text{A}776$ and ICL8021 sockets with or without removal of external nulling components. The value of set resistor for a given supply current varies between types and the manufacturer's data sheets should be consulted for this information. Table 1 compares set resistor values for the OP-22 and the LM4250. (R_{SET} connected to V^-).

TABLE 1
Supply Current vs. Set Resistor for OP-22 and LM4250

V_{SUPPLY}	$I_{SY} = 10\mu\text{A}$		$I_{SY} = 30\mu\text{A}$		$I_{SY} = 100\mu\text{A}$	
	OP-22	LM4250	OP-22	LM4250	OP-22	LM4250
$\pm 1.5\text{V}$	2.2M Ω	1.3M Ω	680k Ω	430k Ω	220k Ω	120k Ω
$\pm 3.0\text{V}$	6.8M Ω	2.7M Ω	2.2M Ω	910k Ω	680k Ω	270k Ω
$\pm 5.0\text{V}$	13M Ω	4.7M Ω	4.3M Ω	1.5M Ω	1.3M Ω	470k Ω
$\pm 12\text{V}$	33M Ω	12M Ω	11M Ω	3.9M Ω	3.3M Ω	1.2M Ω
$\pm 15\text{V}$	43M Ω	15M Ω	15M Ω	5.1M Ω	4.3M Ω	1.5M Ω
I_{SET}	0.67 μA	1.8 μA	2.0 μA	6.0 μA	6.7 μA	20 μA

SET-RESISTOR SELECTION

The value of set resistor for selected supply current may be calculated using the "Supply current vs. Set current" curve and the formula;

$$R_{SET} = \frac{(V_{SUPPLY} - 2V_{BE})}{I_{SET}} \dots\dots\dots (1)$$

Alternatively, the "Supply Current vs. Set Current" graph may be used in conjunction with the "Set Current vs. Set Resistor" graph. V_{SUPPLY} in formula (1) refers to the total supply voltage with R_{SET} connected between pin 8 and negative supply. R_{SET} may be connected to ground in which case V_{SUPPLY} in (1) is the positive supply.

Biasing the OP-22 with a fixed resistor produces a supply current approximately proportional to supply voltage. In applications where a constant drain is required with varying supply, R_{SET} can be replaced by current generators. Two suggested arrangements are shown below:

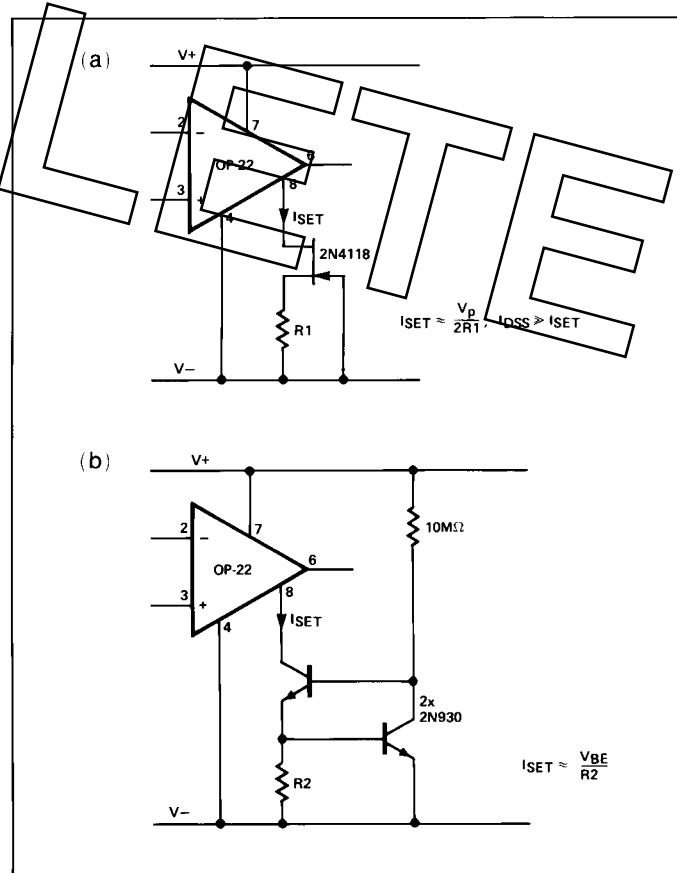

CAUTION: Shorting of pin 8 to negative supply or ground will cause excessive I_{SET} which in turn will cause excessive supply current to flow. I_{SET} should always be limited.

OP-22

OFFSET VOLTAGE ADJUSTMENT

The offset voltage can be trimmed to zero using a 100kΩ potentiometer (see offset nulling circuit). Adjustment range is approximately ±5mV. Resolution of the nulling can be increased by using a smaller pot in conjunction with fixed resistors as shown below.

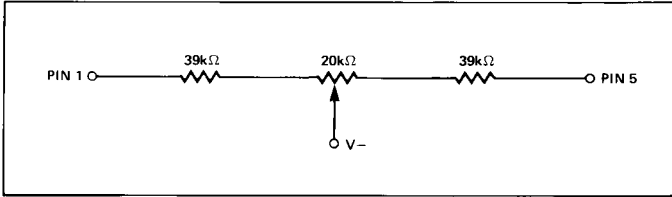

This arrangement has a ±500μV adjustment range. Offset nulling of the OP-22 has negligible effect on the value of TCV_{OS} .

OFFSET NULLING CIRCUIT

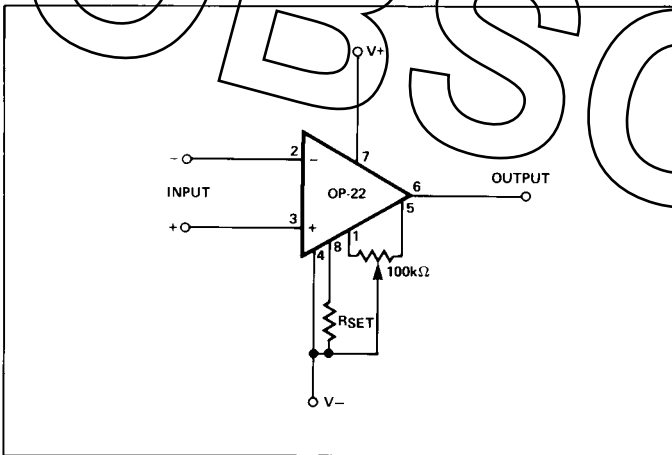

BURN-IN CIRCUIT*

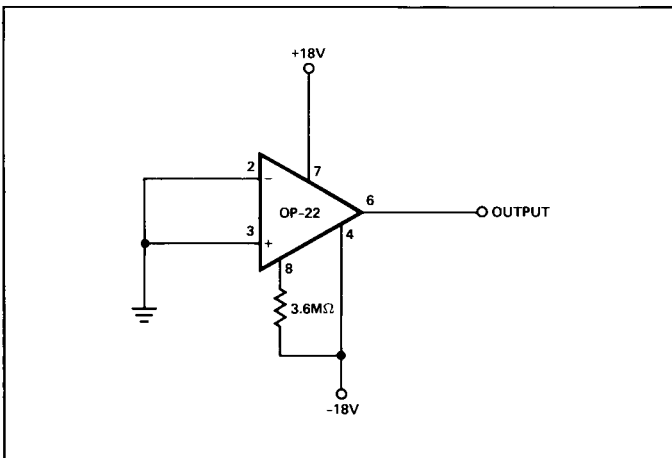

*Other circuits may apply at ADI's discretion.

APPLICATIONS CIRCUITS

A micropower bandgap voltage reference operating at a quiescent current of 15μA may be constructed using an OP-22 and a MAT-01 dual transistor (see Figure 1). The circuit provides a 1.23V reference with better performance than micropower I.C. shunt regulators and has the advantages of being a series regulator.

MICROPOWER 1.23 VOLT BANDGAP REFERENCE

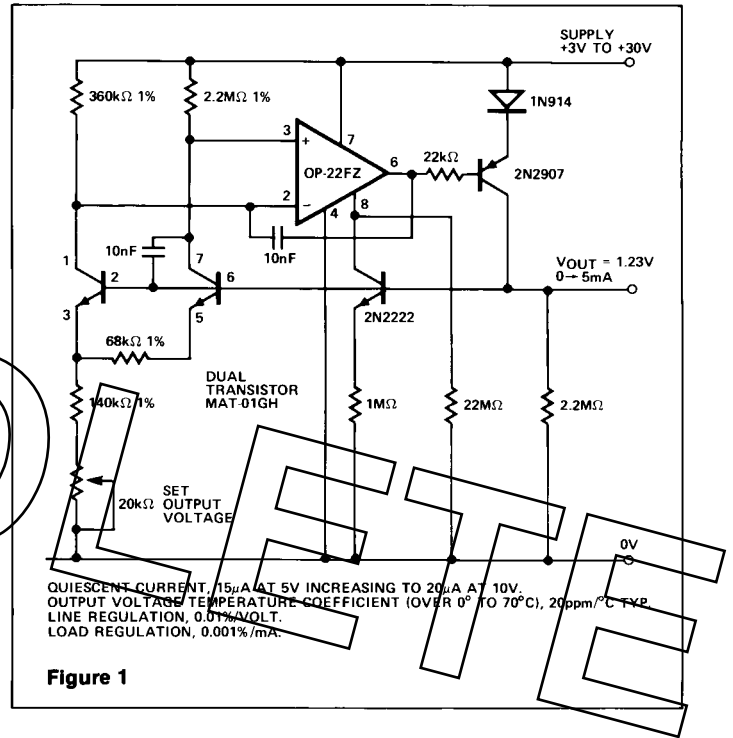

Figure 1

GATED MICROPOWER AMPLIFIER

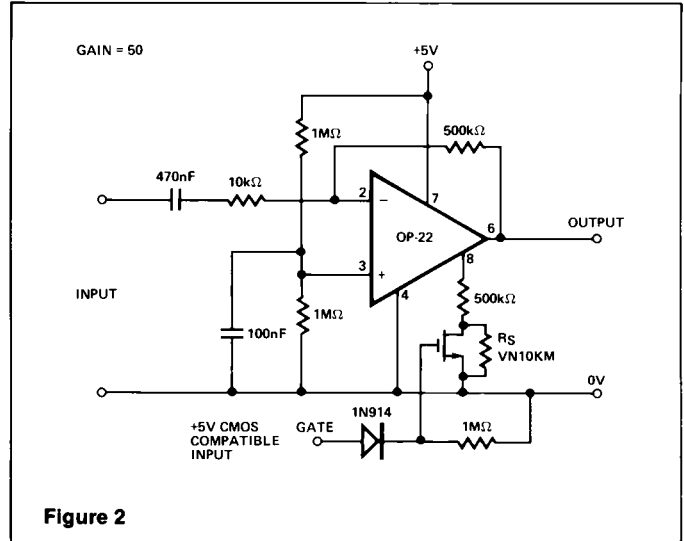

Figure 2

MICROPOWER INSTRUMENTATION AMPLIFIER — POWER DRAIN $\leq 3\text{mW}$ WITH $\pm 5\text{V}$ SUPPLIES

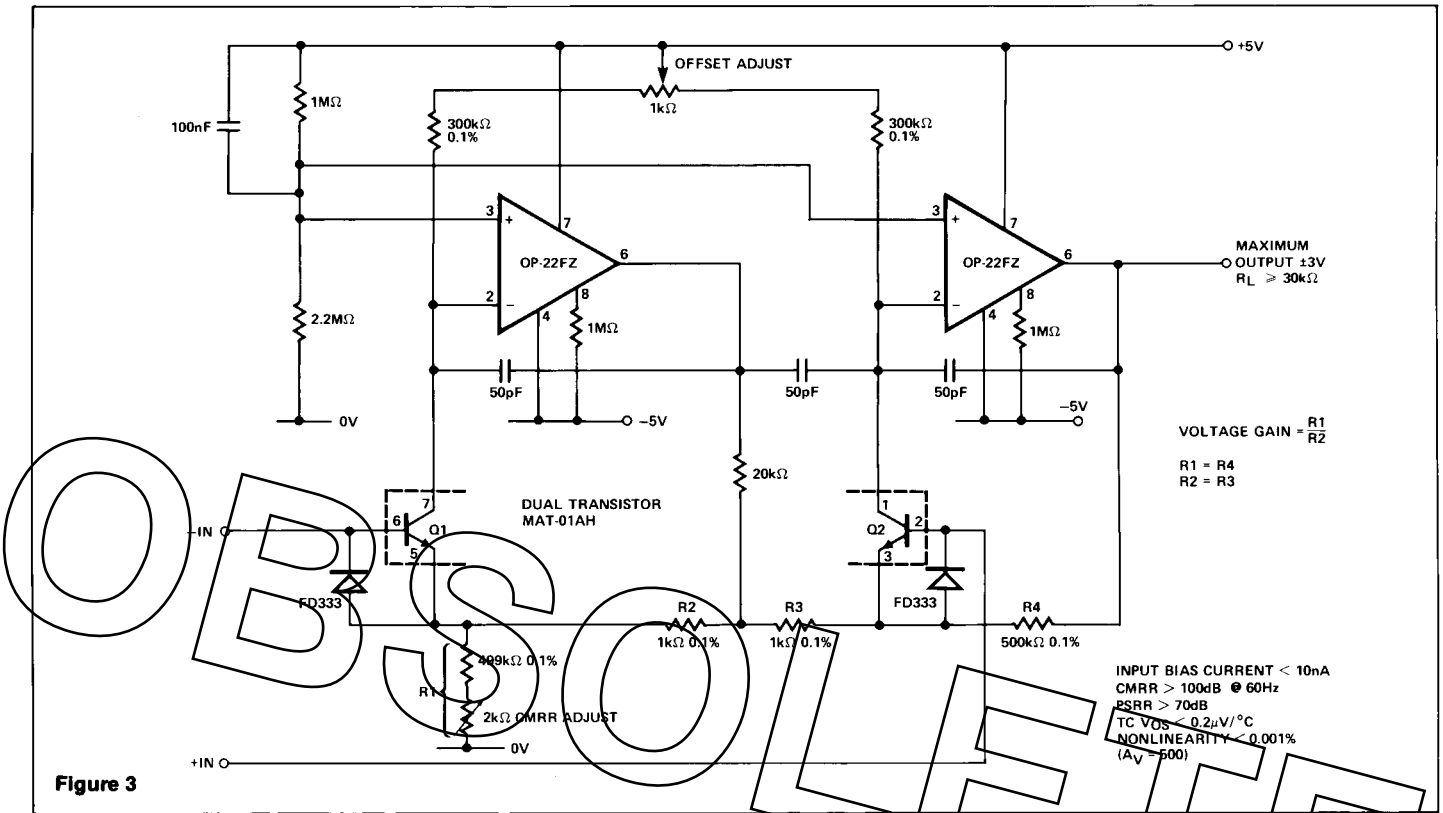

Figure 3

In Figure 2, the OP-22 is used as a gated amplifier where power consumption and bandwidth are controllable. R_S can be selected for a specific lower-power operation or omitted so the amplifier can be completely shut down.

A micropower instrumentation amplifier that consumes less than 3mW with $\pm 5\text{V}$ supplies is shown in Figure 3. Offset voltage drift is less than $0.2\mu\text{V}/^\circ\text{C}$ and common-mode input range is $\pm 3\text{V}$ with CMRR of over 100dB at 60Hz.

Process control systems use two-wire 4-20mA current transmitters when sending analog signals through noisy environments. The "zero" or "offset" current of 4mA may be used to power the transmitter signal conditioning amplifiers and/or excite a d.c. transducer. This allows remote signal conditioning without having a remote power source. Power is provided at the receiving end where the signal current is monitored by a precision 50Ω resistor. The 4-20mA transmitter shown in Figure 4 has high stability, excellent linearity, and generates the 4-20mA current output. A 5V reference is available for powering transducers and micropower amplifiers at a maximum current of 2mA.

TWO TERMINAL 4-20mA TRANSMITTER

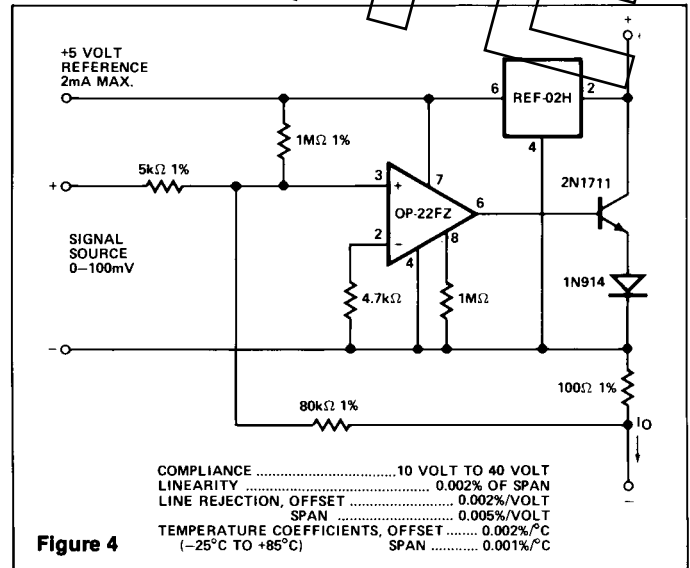

Figure 4

OP-22

MICROPOWER WIEN-BRIDGE OSCILLATOR ($P_d < 500\mu W$)

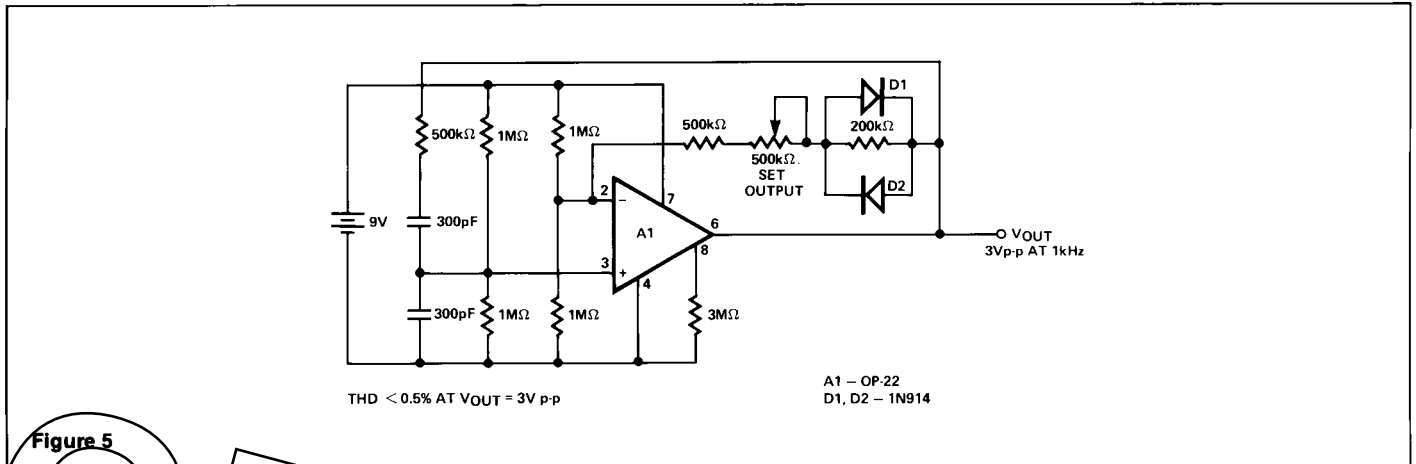

Figure 5

MICROPOWER 5 VOLT REGULATOR

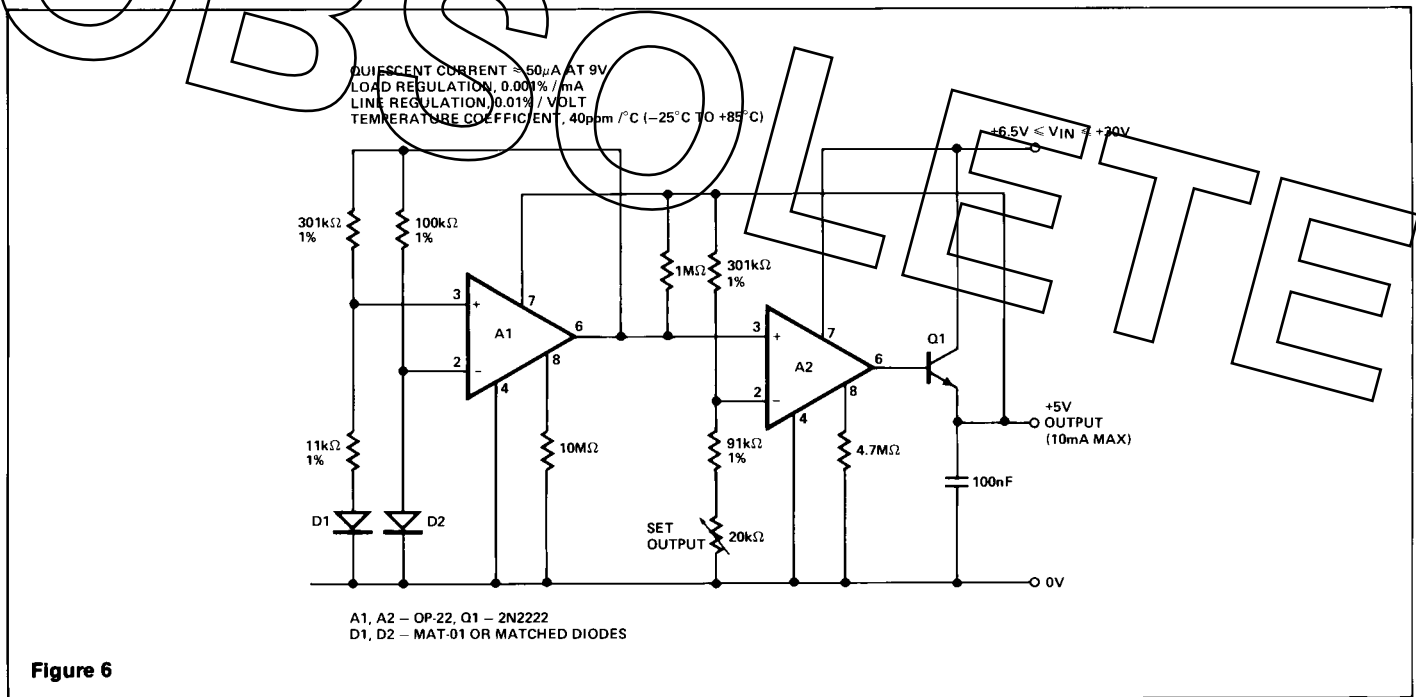

Figure 6

Figure 5 shows a micropower Wien-bridge oscillator designed for battery-powered instrumentation. Output level is controlled by nonlinear elements D1 and D2. When adjusted for 3V p-p output, the distortion level is below 0.5% at 1kHz.

The 5 volt regulator in Figure 6 is intended for instrumentation requiring good power efficiency. Low-power 3-terminal

IC regulators typically draw 2mA to 5mA quiescent current compared to only 50μA with this discrete implementation. Maximum load current is 10mA as shown, and can be increased by changing Q1 to a power transistor and proportionately increasing the set current of A2.