

2.5V Video Amplifier with Reconstruction Filter

General Description

The MAX9502 small, low-power video amplifier with integrated reconstruction filter operates from a supply voltage as low as 2.5V. The small size and the low minimum supply voltage make the MAX9502 ideal for portable applications or small, low-power applications.

The MAX9502 DC-couples the input and the output, resulting in a very small solution. The MAX9502 input can be directly connected to the output of a video digital-to-analog converter (DAC). The reconstruction filter is implemented as a 4th-order Chebyshev with a minimum passband of 5.5MHz, 3dB attenuation at 8MHz, and 55dB attenuation at 27MHz.

The output amplifier provides a closed-loop gain of +6dB (MAX9502G) or +12dB (MAX9502M), and can drive a 2V_{p-p} video signal into a 150Ω load to ground. The output signal is level-shifted so the sync tip is 110mV (typ) above ground.

The MAX9502 operates from a 2.5V to 3.6V single supply and consumes only 5.3mA quiescent supply current. An active-low shutdown mode reduces the supply current to 0.01μA.

The MAX9502 is available in tiny 6-pin μDFN (1mm x 1.5mm x 0.8mm) and 5-pin SC70 packages. The device is specified over the -40°C to +85°C extended and -40°C to +125°C automotive temperature ranges.

Applications

Mobile Phones
Digital Still Cameras
Portable Video
Automotive
Security/CCTV

Pin Configurations appear at end of data sheet.

Features

- ◆ Tiny 6-Pin μDFN (1mm x 1.5mm x 0.8mm) and 5-Pin SC70 Packages
- ◆ DC-Coupled Input and Output Save Board Space
- ◆ 4-Pole Chebyshev Filter
- ◆ 5.5MHz Passband
- ◆ 55dB Attenuation at 27MHz
- ◆ 0.01μA Low-Current Shutdown Mode
- ◆ 2.5V to 3.6V Single-Supply Operation
- ◆ Video Amplifier with Fixed Gains of +6dB (MAX9502G) or +12dB (MAX9502M)

Typical Operating Circuit

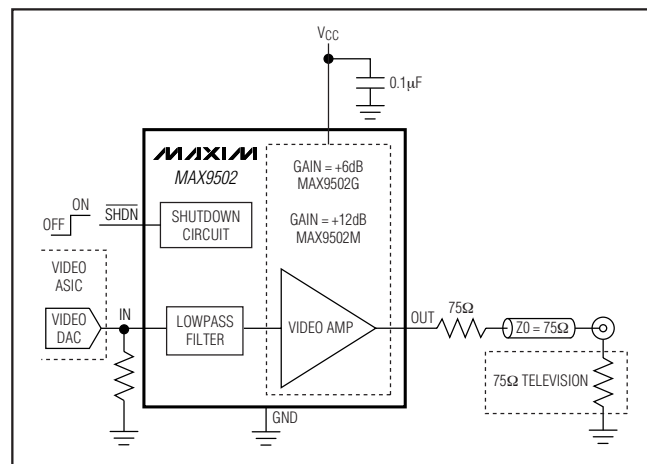

Other Portable Video Amplifiers

PRODUCT	FEATURES
MAX9503	DirectDrive™, LPF, TQFN
MAX9505	DirectDrive, LPF, analog switch, TQFN
MAX4090	Input clamp, μDFN, SOT23, SC70
MAX9504	Optional DC offset bias, μDFN, SOT23

Ordering Information

PART	PIN-PACKAGE	TEMP RANGE	GAIN	TOP MARK	PKG CODE
MAX9502GAALT+T	6 μDFN-6	-40°C to +125°C	+6	LI	L611-1
MAX9502GAAXK+T	5 SC70-5	-40°C to +125°C	+6	ASO	X5-1
MAX9502GELT+T	6 μDFN-6	-40°C to +85°C	+6	AU	L611-1
MAX9502GEXK+T	5 SC70-5	-40°C to +85°C	+6	ARV	X5-1

Ordering Information continued at end of data sheet.

+Denotes lead-free package.

2.5V Video Amplifier with Reconstruction Filter

ABSOLUTE MAXIMUM RATINGS

V_{CC} to GND	-0.3V to +4V
SHDN, IN, OUT to GND.....	-0.3V to ($V_{CC} + 0.3V$)
OUT Short-Circuit Duration to V_{CC} , GND.....	Continuous
Continuous Power Dissipation ($T_A = +70^\circ\text{C}$)	
5-Pin SC70 (derate 3.1mW/ $^\circ\text{C}$ above $+70^\circ\text{C}$).....	.247mW
6-Pin μDFN (derate 2.1mW/ $^\circ\text{C}$ above $+70^\circ\text{C}$).....	.168mW

Operating Temperature Ranges:

MAX9502GE/ME	-40 $^\circ\text{C}$ to +85 $^\circ\text{C}$
MAX9502GA/MA.....	-40 $^\circ\text{C}$ to +125 $^\circ\text{C}$
Junction Temperature	+150 $^\circ\text{C}$
Storage Temperature Range	-65 $^\circ\text{C}$ to +150 $^\circ\text{C}$
Lead Temperature (soldering, 10s).....	+300 $^\circ\text{C}$

Stresses beyond those listed under "Absolute Maximum Ratings" may cause permanent damage to the device. These are stress ratings only, and functional operation of the device at these or any other conditions beyond those indicated in the operational sections of the specifications is not implied. Exposure to absolute maximum rating conditions for extended periods may affect device reliability.

DC ELECTRICAL CHARACTERISTICS

($V_{CC} = \overline{\text{SHDN}} = 3.0\text{V}$, GND = 0V, no load, $T_A = T_{\text{MIN}}$ to T_{MAX} , unless otherwise noted. Typical values are at $T_A = +25^\circ\text{C}$, unless otherwise noted.) (Note 1)

PARAMETER	SYMBOL	CONDITIONS	MIN	TYP	MAX	UNITS	
Supply Voltage Range	V_{CC}	Guaranteed by PSRR	2.5		3.6	V	
Quiescent Supply Current	I_{CC}	$V_{IN} = 0\text{V}$, $2.5\text{V} \leq V_{CC} \leq 3.6\text{V}$, $\overline{\text{SHDN}} = V_{CC}$, $T_A = -40^\circ\text{C}$ to $+85^\circ\text{C}$		5.3	9	mA	
		$V_{IN} = 0\text{V}$, $2.5\text{V} \leq V_{CC} \leq 3.6\text{V}$, $\overline{\text{SHDN}} = V_{CC}$, $T_A = -40^\circ\text{C}$ to $+125^\circ\text{C}$			11		
Shutdown Supply Current	I_{SHDN}	$V_{\text{SHDN}} = 0\text{V}$		0.01	1	μA	
Input Voltage Range	V_{IN}	Guaranteed by DC voltage gain (MAX9502G)	$V_{CC} = 2.5\text{V}$	0	1.05	V	
			$V_{CC} = 3.0\text{V}$	0	1.2		
		Guaranteed by DC voltage gain (MAX9502M)	$V_{CC} = 2.5\text{V}$	0	0.525		
			$V_{CC} = 3.0\text{V}$	0	0.6		
Input Current	I_{IN}	$V_{IN} = 0\text{V}$		3.5	10	μA	
Input Resistance	R_{IN}	$\Delta V_{IN}/\Delta I_{IN}$		17		$\text{M}\Omega$	
DC Voltage Gain (Note 2)	A_V	$R_L = 150\Omega$ to GND, $V_{CC} = 2.5\text{V}$ to 3V	MAX9502G	5.5	6	6.5	dB
			MAX9502M	11.5	12	12.5	
Output Sync-Tip Level	V_{STIP}	Measured at OUT, $V_{IN} = 0\text{V}$, $R_L = 150\Omega$ to GND		110	230	mV	
Output Voltage Swing	V_{OUT}	MAX9502G, $R_L = 150\Omega$ to GND	$V_{CC} = 2.5\text{V}$, $0 \leq V_{IN} \leq 1.05\text{V}$	1.97	2.1	2.23	V_{P-P}
			$V_{CC} = 3.0\text{V}$, $0 \leq V_{IN} \leq 1.2\text{V}$	2.26	2.4	2.54	
		MAX9502M, $R_L = 150\Omega$ to GND	$V_{CC} = 2.5\text{V}$, $0 \leq V_{IN} \leq 0.525\text{V}$	1.97	2.1	2.23	
			$V_{CC} = 3.0\text{V}$, $0 \leq V_{IN} \leq 0.6\text{V}$	2.26	2.4	2.54	
Output Short-Circuit Current Threshold	I_{SC}	Sourcing (Note 3)		95		mA	
Output Resistance	R_{OUT}			0.15		Ω	
Shutdown Output Impedance	$R_{OUT(OFF)}$	$V_{\text{SHDN}} = 0\text{V}$		4		$\text{k}\Omega$	
DC Power-Supply Rejection Ratio	PSRR_{DC}	$V_{IN} = 0\text{V}$, $2.5\text{V} \leq V_{CC} \leq 3.6\text{V}$	50	90		dB	
LOGIC INPUTS ($\overline{\text{SHDN}}$)							
Logic-Low Level	V_{IL}	$T_A = -40^\circ\text{C}$ to $+85^\circ\text{C}$			0.8	V	
		$T_A = -40^\circ\text{C}$ to $+125^\circ\text{C}$			0.65		
Logic-High Level	V_{IH}		2.0			V	
Logic Input Current	I_{IL}	$\overline{\text{SHDN}} = \text{GND}$ and V_{CC}			1	μA	

2.5V Video Amplifier with Reconstruction Filter

AC ELECTRICAL CHARACTERISTICS

($V_{CC} = \overline{SHDN} = 3.0V$, $GND = 0V$, $R_L = 150\Omega$ to GND , $T_A = +25^\circ C$, unless otherwise noted.) (Note 1)

PARAMETER	SYMBOL	CONDITIONS	MIN	TYP	MAX	UNITS
Passband Flatness		$V_{OUT} = 2V_{P-P}$, $f = 100kHz$ to $5.5MHz$, flatness is referred to $100kHz$	-1		+1	dB
Attenuation	f_{dt}	$V_{OUT} = 2V_{P-P}$, attenuation is referred to $100kHz$	$f = 8MHz$	3		dB
			$f = 27MHz$	35	55	
Power-Supply Rejection Ratio	PSRR	$f = 100kHz$		56		dB
Output Impedance	Z_{OUT}	$V_{OUT} = 1.5V$ DC; $f = 5MHz$		2.5		Ω
Differential Gain Error	DG	NTSC, $V_{OUT} = 2V_{P-P}$	MAX9502G	0.4		%
			MAX9502M	0.4		
Differential Phase Error	DP	NTSC, $V_{OUT} = 2V_{P-P}$	MAX9502G	0.4		degrees
			MAX9502M	0.4		
2T Pulse-to-Bar K Rating		$2T = 250ns$; bar time is $18\mu s$; the beginning 2.5% and the ending 2.5% of the bar time are ignored		0.2		K%
2T Pulse Response		$2T = 250ns$		0.3		K%
2T Bar Response		$2T = 250ns$; bar time is $18\mu s$; the beginning 2.5% and the ending 2.5% of the bar time are ignored		0.4		K%
Nonlinearity		5-step staircase		0.4		%
Line Time Distortion				0		%
Field Time Distortion				0		%
Group-Delay Variation	$\Delta(d\phi/d\omega)$	$f = 100kHz$ to $5.5MHz$	MAX9502G	30		ns
			MAX9502M	30		
Peak Signal to RMS Noise	SNR	$V_{OUT} = 2V_{P-P}$, $100kHz$ to $5MHz$	MAX9502G	68		dB
			MAX9502M	65		
Enable Time	t_{ON}	$\overline{VSHDN} = 3V$, V_{OUT} settled to within 1% of the final voltage	MAX9502G ($V_{IN} = 1V$)	800		ns
			MAX9502M ($V_{IN} = 0.5V$)	800		
Disable Time	t_{OFF}	$\overline{VSHDN} = 0V$, V_{OUT} settled to below 1% of the output voltage	MAX9502G ($V_{IN} = 1V$)	220		ns
			MAX9502M ($V_{IN} = 0.5V$)	175		

Note 1: All devices are 100% production tested at $T_A = +25^\circ C$. Specifications over temperature limits are guaranteed by design.

Note 2: DC voltage gain (A_V) is a two-point measurement in which the output voltage swing is divided by the input voltage swing.

Note 3: Short-circuit current is the trip current for the protection. During the protection, OUT is switched alternatively on and off.

2.5V Video Amplifier with Reconstruction Filter

Typical Operating Characteristics

($V_{CC} = \overline{SHDN} = 3.0V$, $GND = 0V$, $R_L = 150\Omega$ to GND .)

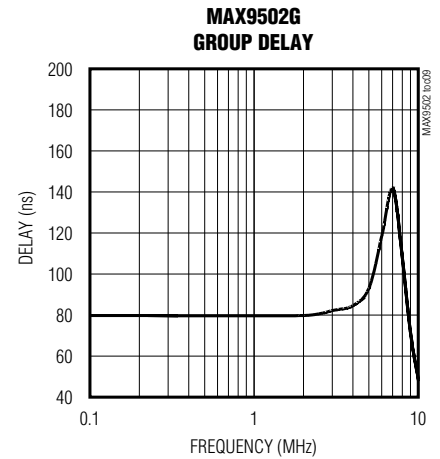
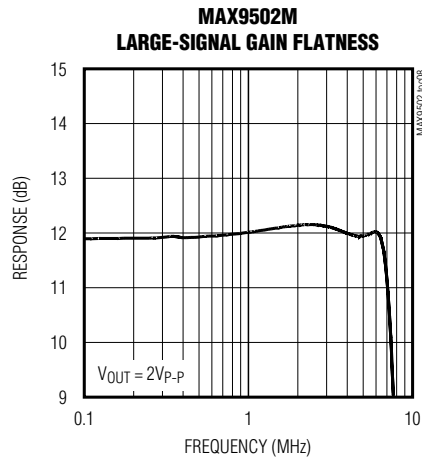
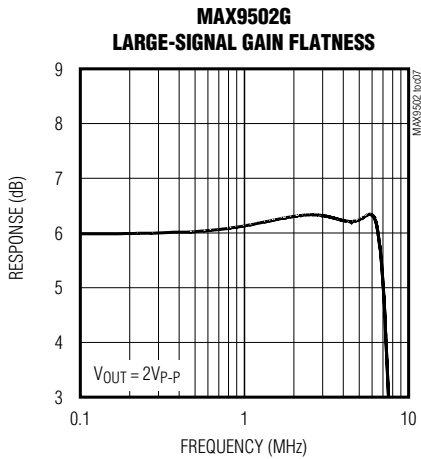
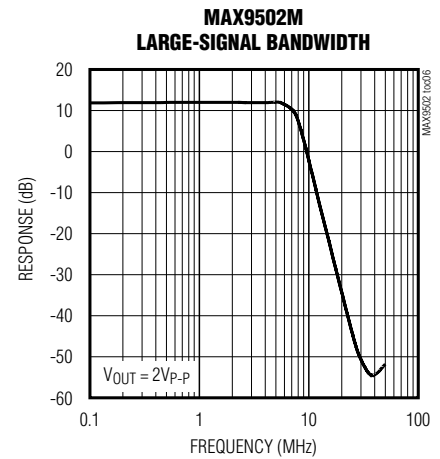
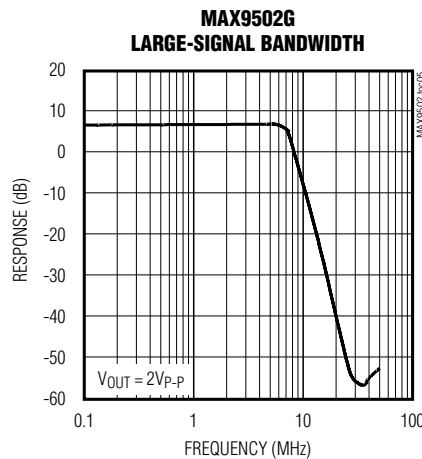
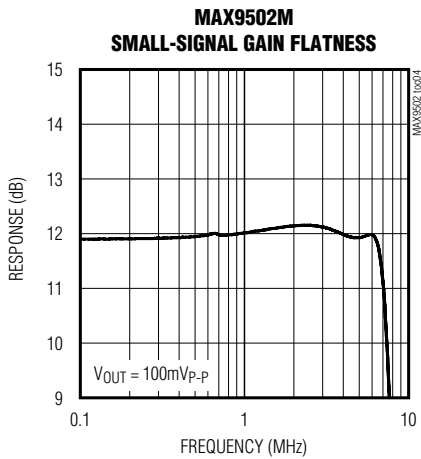
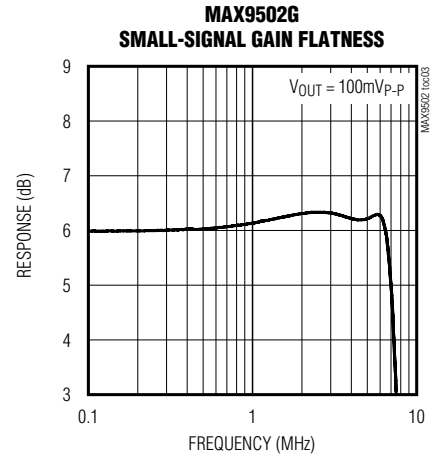
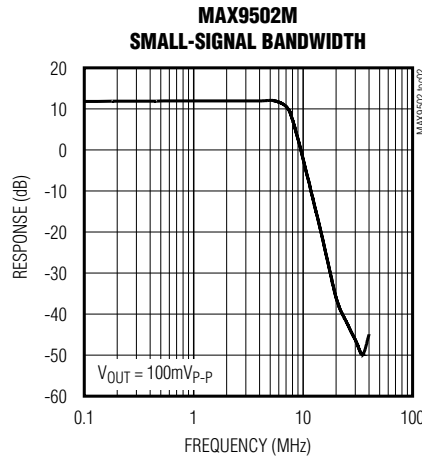
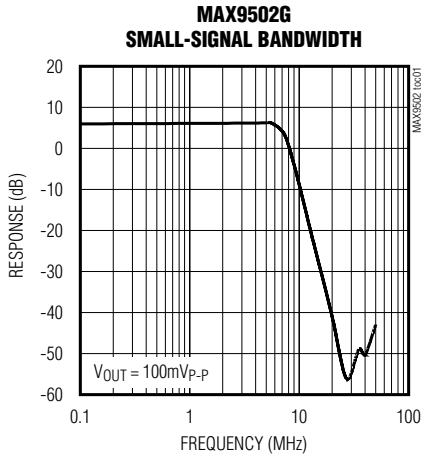

2.5V Video Amplifier with Reconstruction Filter

Typical Operating Characteristics (continued)

($V_{CC} = \overline{SHDN} = 3.0V$, $GND = 0V$, $R_L = 150\Omega$ to GND .)

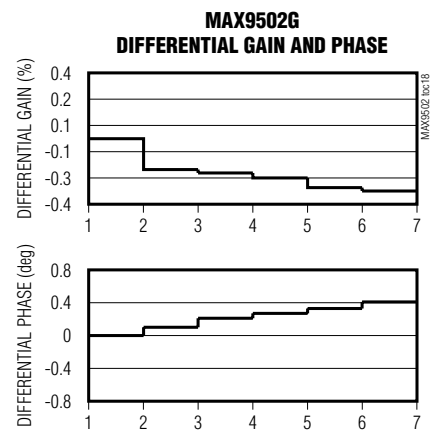
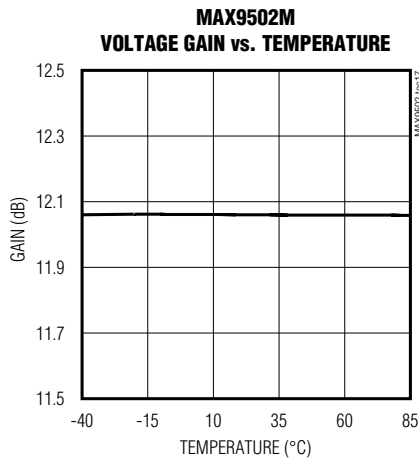
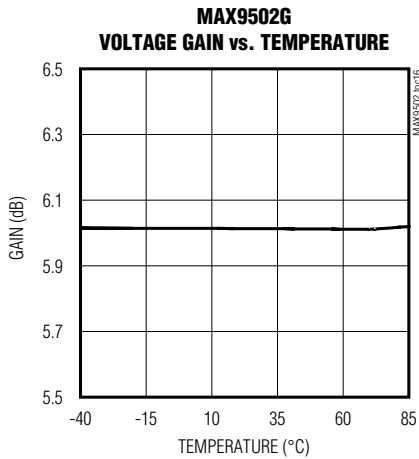
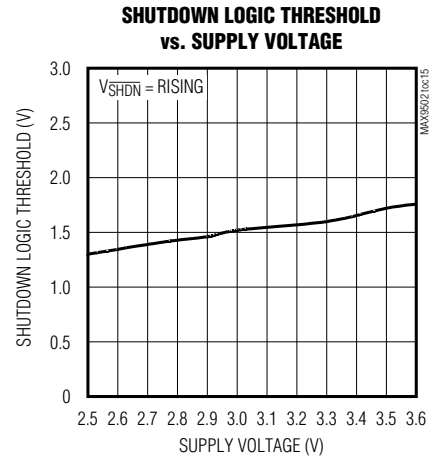
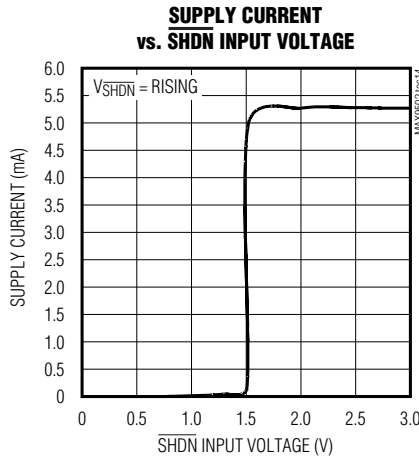
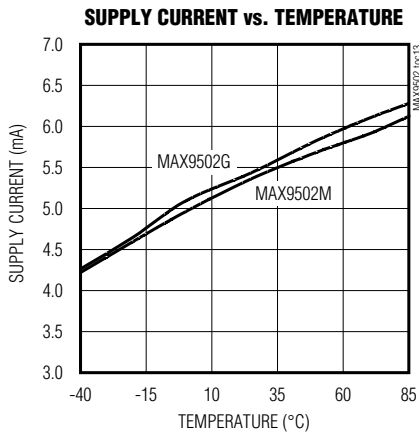
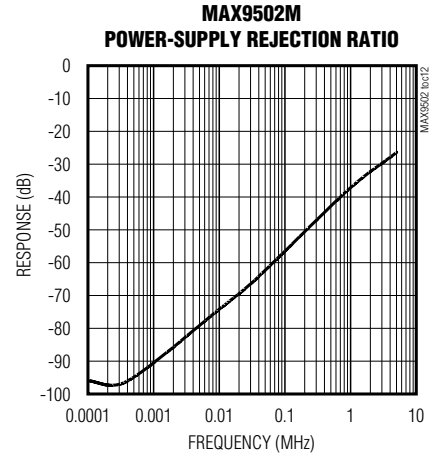
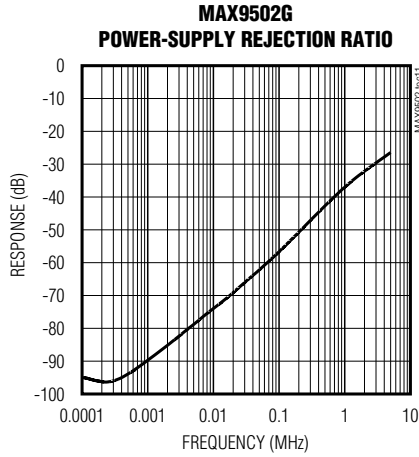
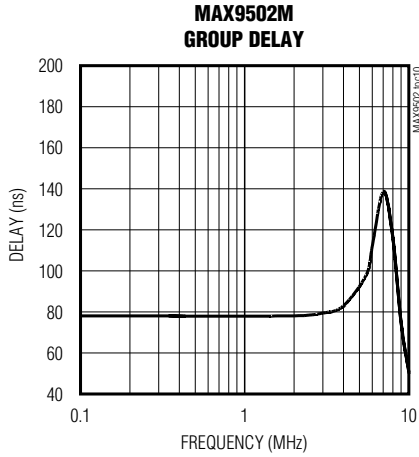

2.5V Video Amplifier with Reconstruction Filter

Typical Operating Characteristics (continued)

($V_{CC} = \overline{SHDN} = 3.0V$, $GND = 0V$, $R_L = 150\Omega$ to GND .)

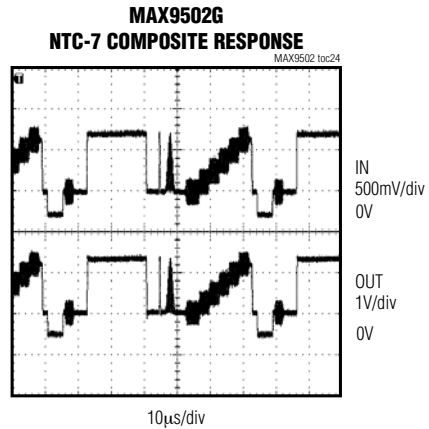
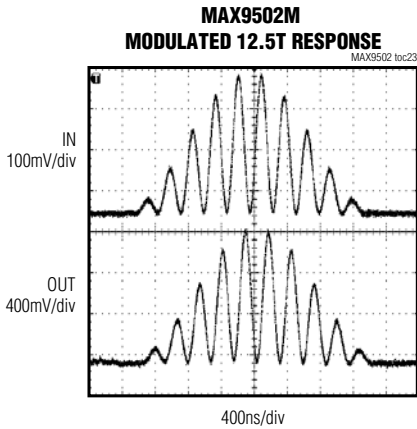
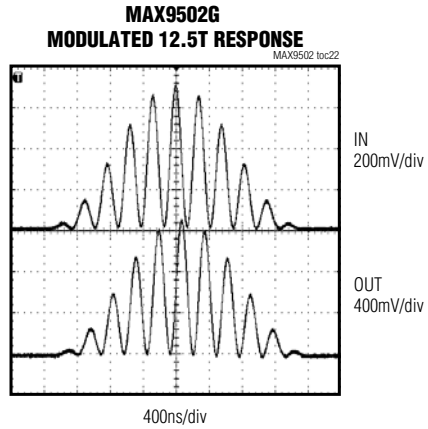
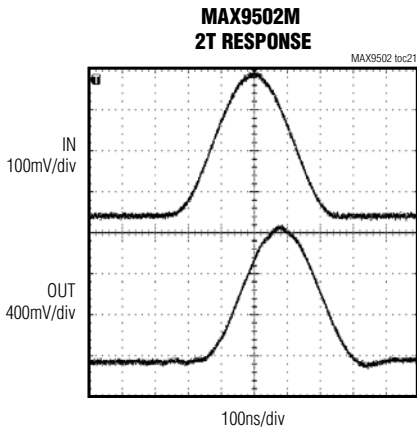
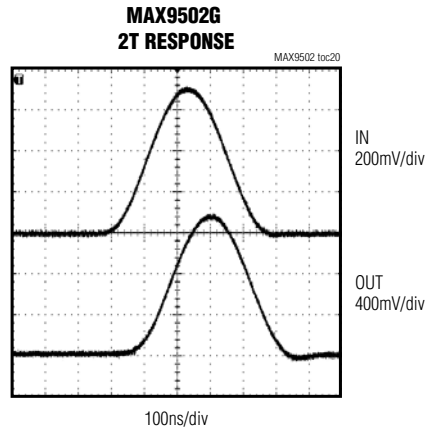
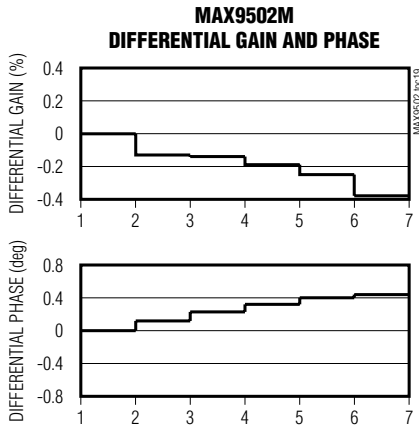

2.5V Video Amplifier with Reconstruction Filter

Typical Operating Characteristics (continued)

($V_{CC} = \overline{SHDN} = 3.0V$, $GND = 0V$, $R_L = 150\Omega$ to GND .)

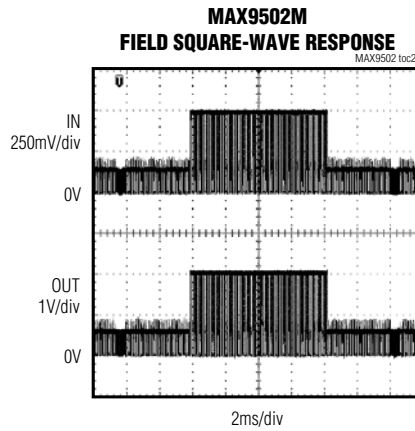
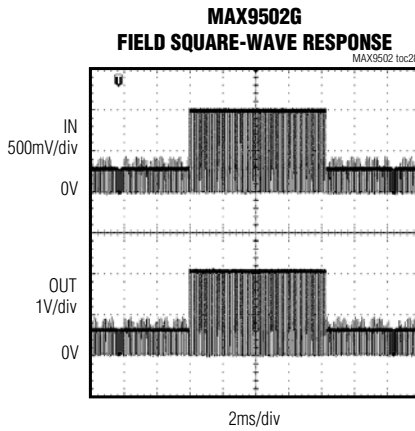
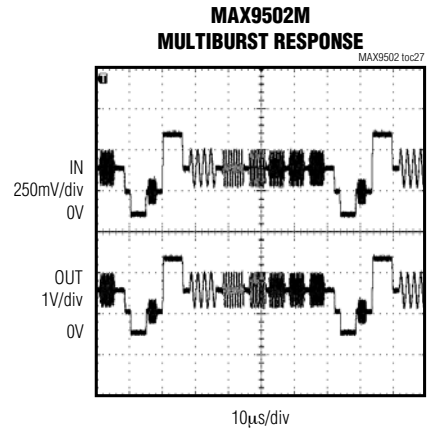
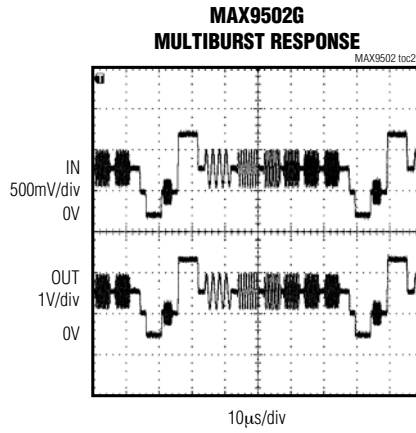
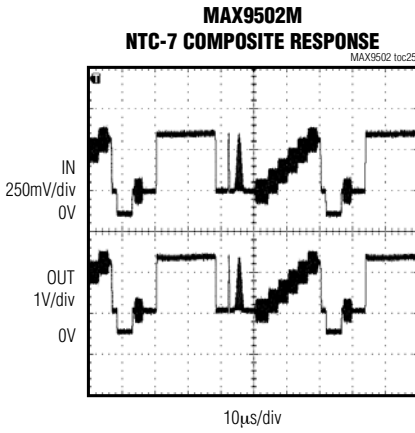

Pin Description

PIN		NAME	FUNCTION
μ DFN	SC70		
1	1	IN	Video Input
2	2	GND	Ground
3	3	\overline{SHDN}	Active-Low Shutdown Input. Connect to GND to shutdown.
4	4	V_{CC}	Positive Power Supply
5	—	N.C.	No Connection. Not internally connected.
6	5	OUT	Video Output

2.5V Video Amplifier with Reconstruction Filter

Detailed Description

The MAX9502 filters and amplifies the video DAC output in applications such as digital still cameras and mobile phones. The MAX9502 consists of a lowpass filter and an output video buffer capable of driving a standard 150 Ω video load to ground. The MAX9502G output buffer provides a fixed gain of +6dB, while the MAX9502M output buffer provides a fixed gain of +12dB.

Filter

The MAX9502 contains a 4th-order Chebyshev reconstruction filter. The Chebyshev-type response features a 0.4dB flat passband for NTSC and PAL signals. The stopband offers 55dB (typ) of attenuation at 27MHz and above (see the *Typical Operating Characteristics*).

Output Amplifier

The MAX9502G features a +6dB gain, while the MAX9502M features a +12dB gain. Operating from a 2.5V to 3.0V supply, the output amplifier is able to drive a 2V signal into a 150 Ω video load to ground. Operating from a 3.0V to 3.6V supply, the output amplifier is able to drive a 2.4V_{P-P} signal into a 150 Ω video load to ground. The output is typically offset 110mV above ground to guarantee linear operation of the amplifier. The MAX9502 output only sources current; all loads should be connected to ground.

Short-Circuit Protection

The MAX9502 typical application circuit includes a 75 Ω back-termination resistor that limits short-circuit currents for an external short applied at the video output. The MAX9502 features internal output short-circuit protection to prevent device damage in prototyping and applications where the amplifier output can be directly shorted.

Short-circuit protection activates if the output is short-circuited and the output current exceeds 95mA. During short-circuit protection, the output of the MAX9502 is shut off for 12 μ s and then turns on for 0.8 μ s. If the short is still present, the MAX9502 output shuts off again. Extended short circuits result in a pulsed output. The device resumes normal operation after the short is removed.

Applications Information

Input Considerations

The MAX9502 input is DC-coupled. When the supply voltage is between a 2.5V and 3V supply, the input voltage range extends from ground to 1.05V for the MAX9502G and from ground to 0.525V for the MAX9502M. When the supply voltage is between 3V and 3.6V, the input voltage range extends from ground to 1.2V for the MAX9502G and from ground to 0.6V for the MAX9502M. The MAX9502G accepts a composite video signal with a sync tip from 0 to 50mV and the MAX9502M accepts a composite video signal with a sync tip from 0 to 25mV. A typical current-output DAC that operates from a single supply usually creates a composite video signal with a sync tip very close to ground. Hence, the DAC output can be directly connected to the MAX9502 input. Keep the board trace as short as possible to minimize parasitic stray capacitance and prevent unintentional high-frequency attenuation.

Output Considerations

The MAX9502 output must be DC-coupled. No AC-coupling capacitors are allowed. The MAX9502 connects directly to the video cable through a 75 Ω series back-termination resistor. The other end of the cable should be properly terminated with a 75 Ω resistor as well. Because of this configuration, the peak-to-peak amplitude as well as the DC level of the signal is divided by two. The MAX9502 output signal is level-shifted up so the sync tip is around 110mV.

Power-Supply Bypassing and Layout Considerations

The MAX9502 operates from a single-supply voltage down to 2.5V, allowing for low-power consumption. Bypass V_{CC} to GND with a 0.1 μ F capacitor. Place all external components as close to the device as possible.

2.5V Video Amplifier with Reconstruction Filter

MAX9502

Ordering Information (continued)

PART	PIN-PACKAGE	TEMP RANGE	GAIN	TOP MARK	PKG CODE
MAX9502MAALT+T	6 μ DFN-6	-40°C to +125°C	+12	LJ	L611-1
MAX9502MAAXK+T	5 SC70-5	-40°C to +125°C	+12	ASP	X5-1
MAX9502MELT+T	6 μ DFN-6	-40°C to +85°C	+12	AV	L611-1
MAX9502MEXK+T	5 SC70-5	-40°C to +85°C	+12	ARW	X5-1

+Denotes lead-free package.

Pin Configurations

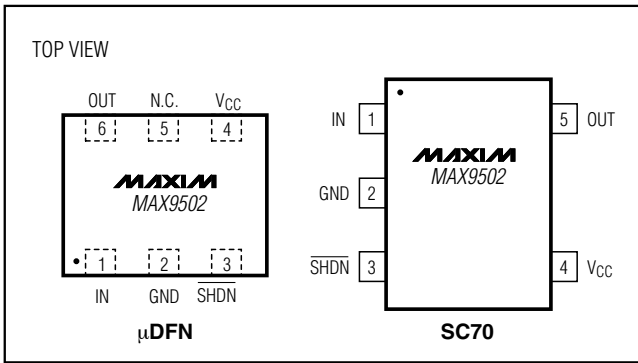

Chip Information

PROCESS: BICMOS

2.5V Video Amplifier with Reconstruction Filter

Package Information

(The package drawing(s) in this data sheet may not reflect the most current specifications. For the latest package outline information go to www.maxim-ic.com/packages.)

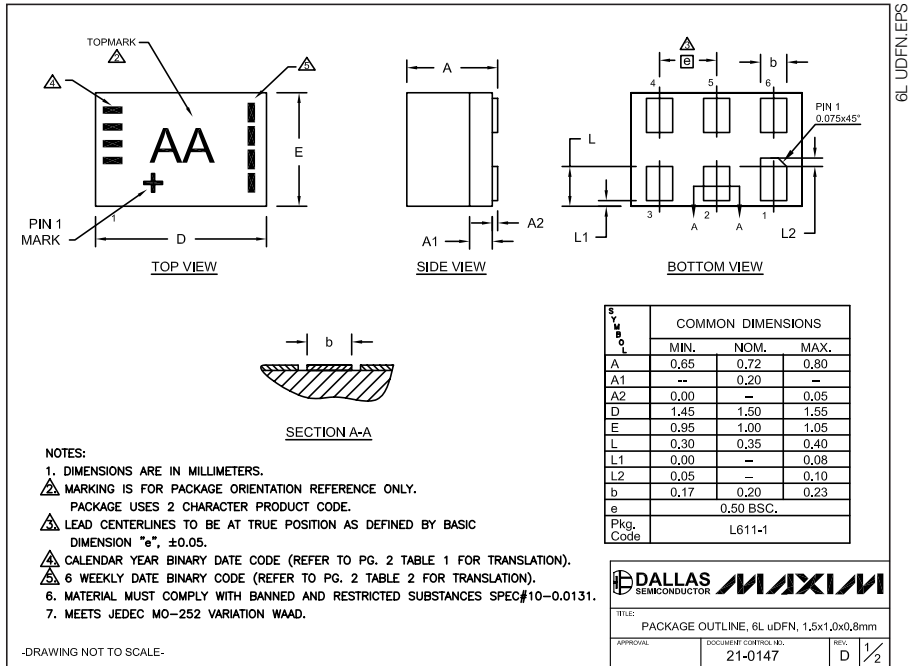

2.5V Video Amplifier with Reconstruction Filter

Package Information (continued)

(The package drawing(s) in this data sheet may not reflect the most current specifications. For the latest package outline information, go to www.maxim-ic.com/packages.)

MAX9502

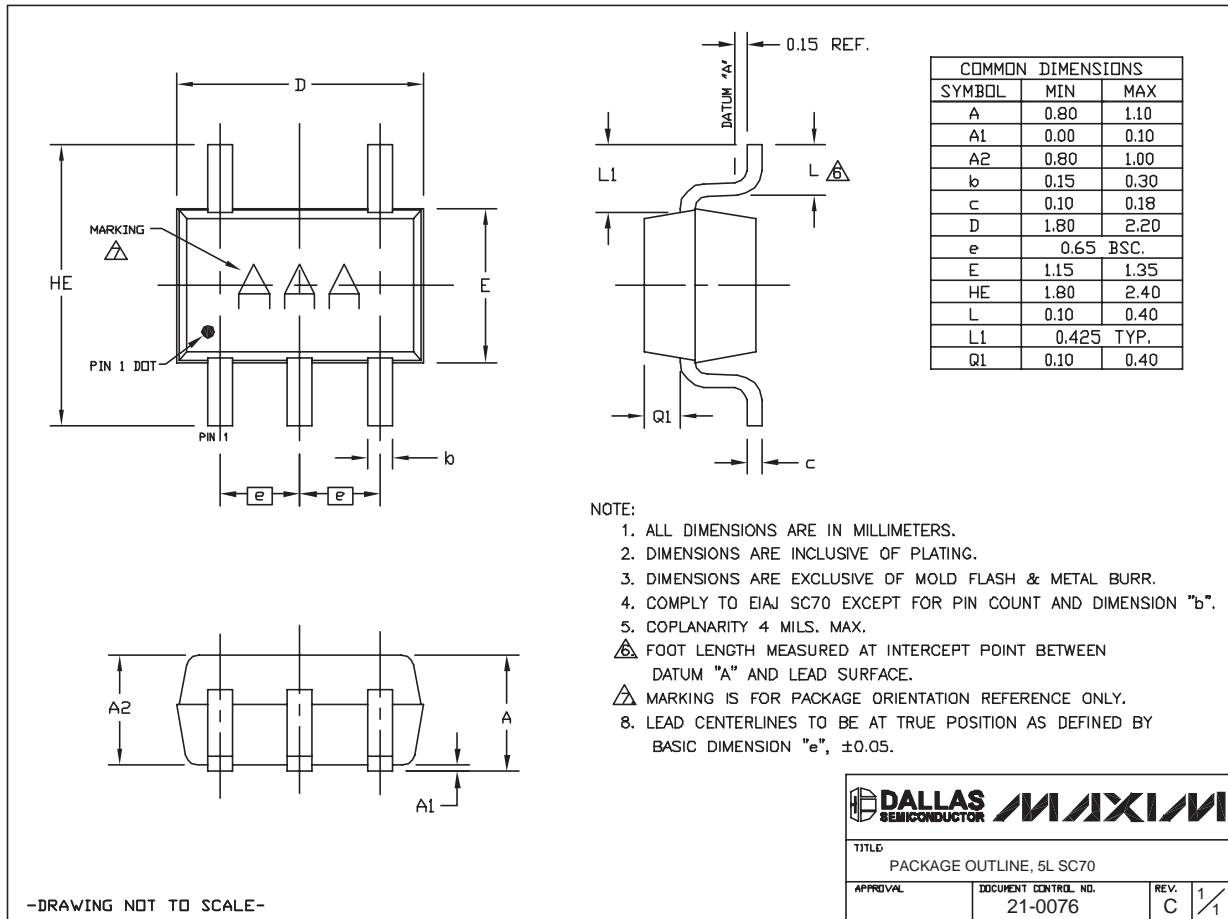

Maxim cannot assume responsibility for use of any circuitry other than circuitry entirely embodied in a Maxim product. No circuit patent licenses are implied. Maxim reserves the right to change the circuitry and specifications without notice at any time.

Maxim Integrated Products, 120 San Gabriel Drive, Sunnyvale, CA 94086 408-737-7600 11