

MAXIM

Low Voltage Reference

ICL8069

General Description

The ICL8069 is a 1.2V temperature compensated voltage reference. It uses the band-gap principle to achieve excellent stability and low noise at reverse currents down to 50 μ A. Maxim's ICL8069 also features excellent stability, freedom from oscillation.

Applications

Analog to Digital Converters
 Digital to Analog Converters
 Threshold Detectors
 Voltage Regulators
 Portable Instruments

Typical Operating Circuits

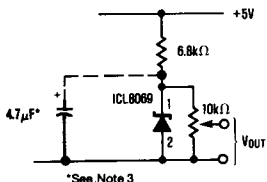

(a) Simple Reference (1.2 Volts or Less)

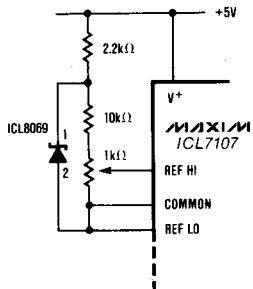

(b) Double Regulated 100mV Reference for ICL7107 One-Chip DPM Circuit.

Pin Configuration

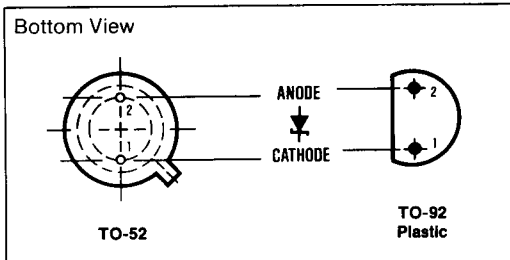

Features

- ◆ Temperature Coefficient Guaranteed to 10ppm/°C Max.
- ◆ Low Bias Current . . . 50 μ A Min.
- ◆ Low Dynamic Impedance
- ◆ Low Reverse Voltage
- ◆ Low Cost

Ordering Information

PART	TEMP. STABILITY	TEMP. RANGE
TO-92 Plastic:		
ICL8069CCZQ2	0.005%/°C	0°C to +70°C
ICL8069DCZQ2	0.01%/°C	0°C to +70°C
TO-52 Can:		
ICL8069ACSQ2	0.001%/°C	0°C to +70°C
ICL8069BCSQ2	0.0025%/°C	0°C to +70°C
ICL8069CCSQ2	0.005%/°C	0°C to +70°C
ICL8069DCSQ2	0.01%/°C	0°C to +70°C
ICL8069CMSQ2	0.005%/°C	-55°C to +125°C
ICL8069DMSQ2	0.01%/°C	-55°C to +125°C

Package Information

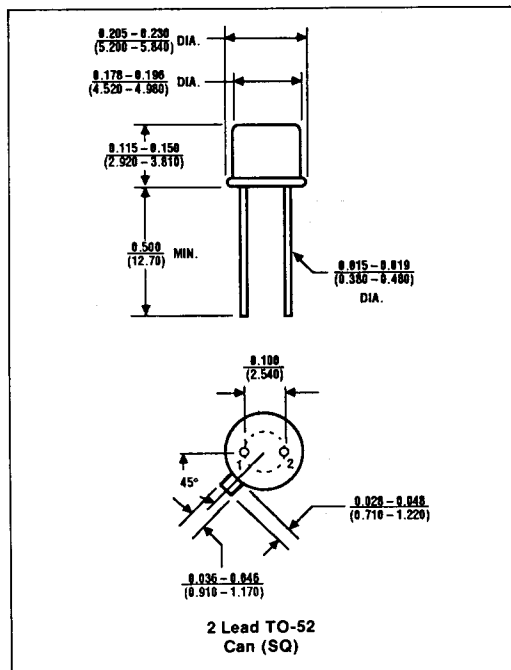

3

Low Voltage Reference

ABSOLUTE MAXIMUM RATINGS

Reverse Voltage See Note 1
 Forward Current 10mA
 Reverse Current 10mA
 Power Dissipation Limited by Max Forward/Reverse Current
 Storage Temperature Range -65°C to +150°C

Operating Temperature
 ICL8069C 0°C to +70°C
 ICL8069M -55°C to +125°C
 Lead Temperature (Soldering, 10 Sec.) 300°C

Stresses above those listed under "Absolute Maximum Ratings" may cause permanent damage to the device. These are stress ratings only and functional operation of the device at these or any other conditions above those indicated in the operational sections of the specifications is not implied. Exposure to absolute maximum rating conditions for extended periods may affect device reliability.

ELECTRICAL CHARACTERISTICS

(T_A = +25°C unless otherwise noted)

CHARACTERISTICS	CONDITIONS	MIN	TYP	MAX	UNITS
Reverse Breakdown Voltage	I _R = 500μA	1.20	1.23	1.25	V
Reverse Breakdown Voltage Change	50μA ≤ I _R ≤ 5mA		15	20	mV
Reverse Dynamic Impedance	I _R = 50μA I _R = 500μA		1 0.6	2 2	Ω
Forward Voltage Drop	I _F = 500μA		0.7	1	V
RMS Noise Voltage	10Hz ≤ f ≤ 10kHz I _R = 500μA		5		μV
Breakdown Voltage Temperature Coefficient: ICL8069A ICL8069B ICL8069C ICL8069D	I _R = 500μA T _A = Operating Temperature Range (Note 2)			.001 .0025 .005 .01	%/°C
Reverse Current Range		.050		5	mA

- Note 1:** In normal use, the reverse voltage cannot exceed the reference voltage. However when plugging units into a powered-up test fixture, an instantaneous voltage equal to the compliance of the test circuit will be seen. This should not exceed 20V.
- Note 2:** For the military devices, measurements are made at 25°C, -55°C, and 125°C, while for the commercial devices measurements are made at 25°C, 0°C and 70°C. The unit is then classified as a function of the worst case TC. Sample tested to 0.1% AQL.
- Note 3:** If circuit strays in excess of 200pF are anticipated, a 4.7μF shunt capacitor will ensure stability under all operating conditions.

Typical Operating Characteristics

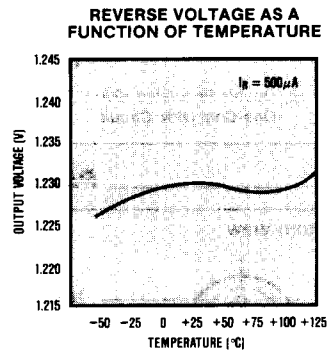
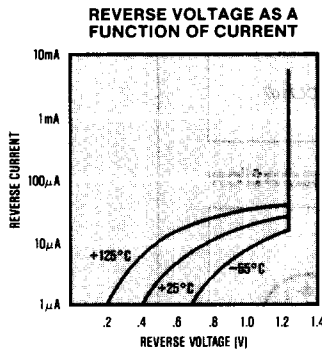
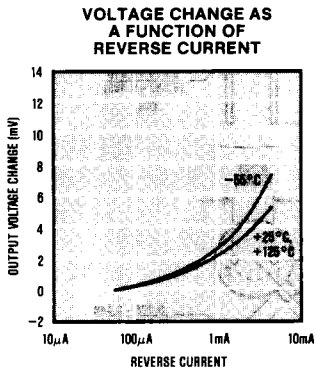

Maxim cannot assume responsibility for use of any circuitry other than circuitry entirely embodied in a Maxim product. No circuit patent licenses are implied. Maxim reserves the right to change the circuitry and specifications without notice at any time.