

丝印标记 MARKING SPECIFICATION

卷盘尺寸 REEL DIMENSIONS

例: 16V 106 A

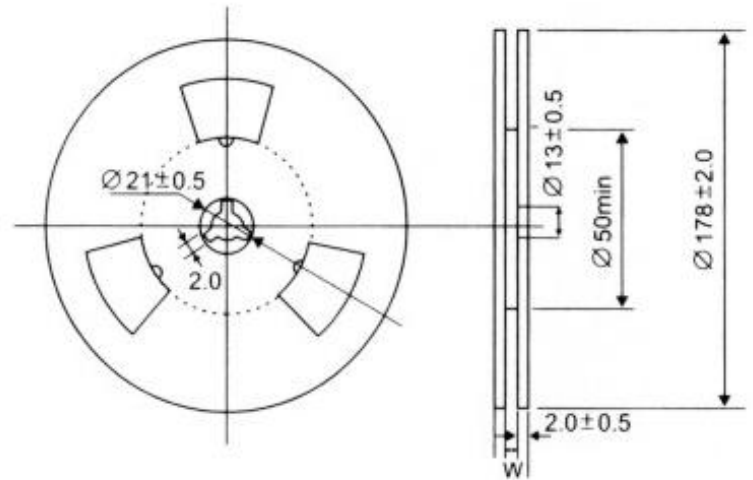
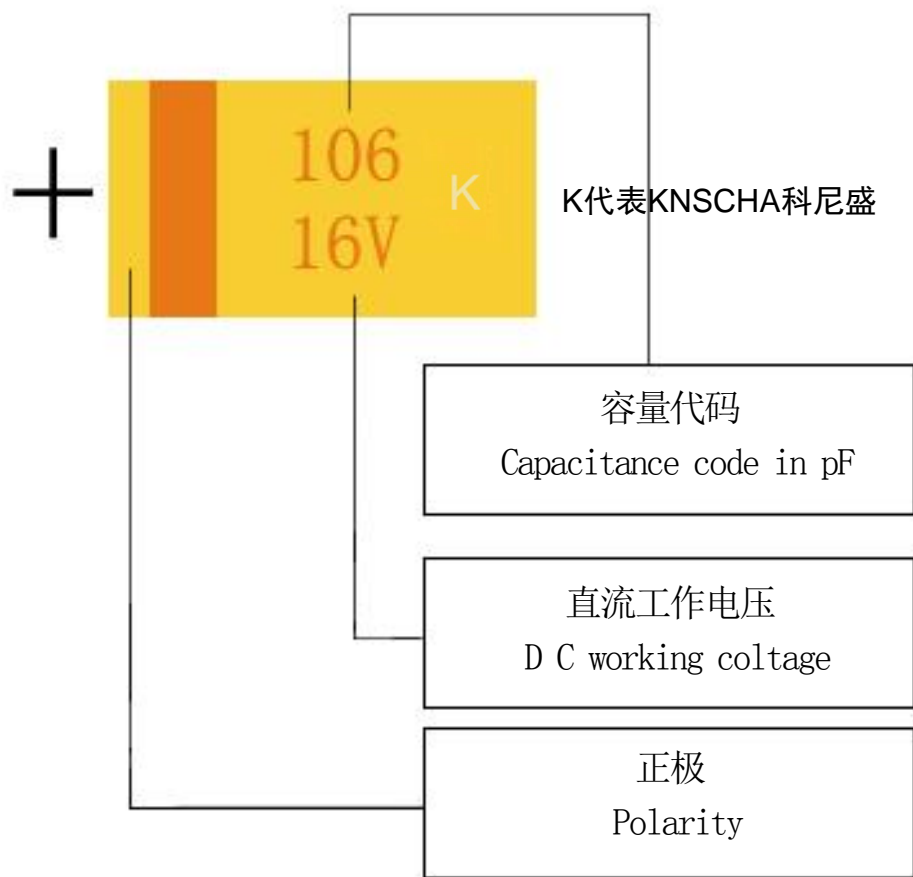

单位 Unit (mm)

壳号 Case size	W	容量 Qty/reel (178mm)
P	8.4 ± 1.5	2500
A、B	8.4 ± 1.5	2000
C、D	12.4 ± 2.0	500
E	12.4 ± 2.0	400

载带尺寸 CARRIER TAPE DIMENSION

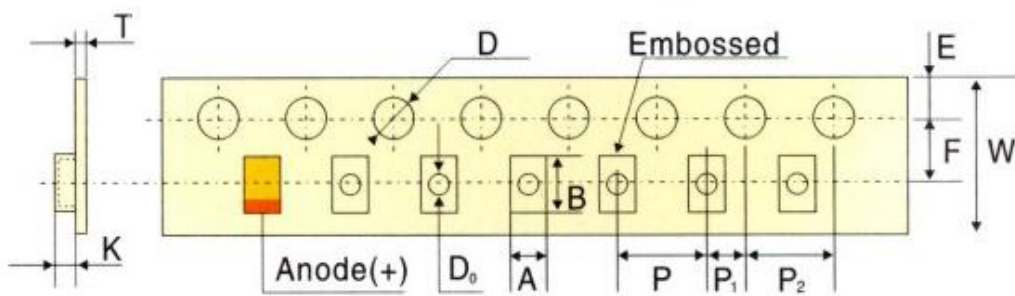

单位 Unit (mm)

CASE CODE	W	F	E	P	P1	P2	D	D0	T	A	K
	±0.3	±0.1	±0.1	±0.1	±0.1	±0.1	±0.1	Min	±.03	±0.2	±0.2
P	8	3.5	1.75	4	2	4	Ø1.5	Ø1.0	0.2	3.5	1.9
A	8	3.5	1.75	4	2	4	Ø1.5	Ø1.0	0.3	3.5	1.9
B	8	3.5	1.75	4	2	4	Ø1.5	Ø1.0	0.3	3.8	2.1
C	12	5.5	1.75	8	2	4	Ø1.5	Ø1.5	0.3	6.4	3.0
D	12	5.5	1.75	8	2	4	Ø1.5	Ø1.5	0.3	7.7	3.3
E	12	5.5	1.75	8	2	4	Ø1.5	Ø1.5	0.3	7.7	3.3

注: 1. 电容量、损耗正切角测量条件:

Measuring conditions of reserve capacity and tangential Angle of loss:
 测量电压: $U = 2.2V \pm 1.0V$ $U = 1.0V \pm 0.5V$ (有效值); 测试频率: 120Hz
 Measurement voltage: $U = 2.2V$ $1.0V$ $U = 1.0V$ $0.5V$ (effective value);
 Test frequency: 120Hz

2. 漏电流测量条件:

Leakage current measurement conditions:
 施加额定电压测量, 充电时间不超过5min (测量125°C漏电流是, 施加类别电压测量)。
 Rated voltage measurement, charging time not more than 5 min (125 °C leakage current measurement is, applying category voltage measurements).

3. 等效串联电阻 (ESR) 测试条件:

Equivalent series resistance (ESR) test conditions:
 测量频率 (120±5) KHz; $U = 2.2V \pm 1.0V$ $U = 1.0V \pm 0.5V$ (有效值)。
 Measurement frequency (120 5) KHz; $U = 2.2V$ $1.0V$ $U = 1.0V$ $0.5V$ (valid values).

参数特性 THE PARAMETER CHARACTERISTIC

容量标称 (μF)	壳号	等效串联电阻	直流漏电流max(μA)			电容量变化范围%		损耗正切角max%		
			+25 $^{\circ}\text{C}$	+85 $^{\circ}\text{C}$	+125 $^{\circ}\text{C}$	-55 $^{\circ}\text{C}$ +85 $^{\circ}\text{C}$	+125 $^{\circ}\text{C}$	-55 $^{\circ}\text{C}$	+25 $^{\circ}\text{C}$	+85 $^{\circ}\text{C}$ +125 $^{\circ}\text{C}$
额定电压6.3V(类别电压4V)										
47	E	1.1	3	29.6	37	± 10	± 12	8	6	8
47	C	2	3	29.6	37	± 10	± 12	8	6	8
47	B	3	3	29.6	37	± 10	± 15	8	6	8
47	A	5	3	29.6	37	± 10	± 15	18	12	15
68	E	0.9	4.3	42.8	53.5	± 10	± 12	8	6	8
68	C	2	4.3	42.8	53.5	± 10	± 12	8	6	8
68	B	1.5	4.3	42.8	53.5	± 10	± 15	12	8	10
100	E	1.2	6.3	63	78.7	± 10	± 12	10	8	10
100	C	1.5	6.3	63	78.7	± 10	± 15	10	8	10
100	B	5	6.3	63	78.7	± 10	± 15	22	15	18
150	E	1	9.5	94.5	118	± 10	± 12	10	8	10
150	C	1.5	9.5	94.5	118	± 10	± 15	10	8	10
150	B	2.8	9.5	94.5	118	± 10	± 15	30	20	24
220	E	1	13.9	139	173	± 10	± 12	10	8	10
220	C	2.4	13.9	139	173	± 10	± 15	15	10	12
330	E	0.9	20.8	208	260	± 10	± 15	12	10	12
330	C	1.8	20.8	208	260	± 10	± 15	22	15	18
470	E	0.9	29.6	296	370	± 10	± 15	18	12	15
额定电压10V(类别电压6.3V)										
1.5	A	8	0.5	5	6.3	± 10	± 12	8	6	8
2.2	A	8	0.5	5	6.3	± 10	± 12	8	6	8
3.3	A	9	0.5	5	6.3	± 10	± 12	8	6	8
4.7	C	3.0	0.5	5	6.3	± 10	± 12	8	6	8
4.7	B	4.5	0.5	5	6.3	± 10	± 12	8	6	8
4.7	A	8	0.5	5	6.3	± 10	± 12	8	6	8
6.8	B	3.5	0.7	6.8	8.5	± 10	± 12	8	6	8
6.8	A	8	0.7	6.8	8.5	± 10	± 15	8	6	8
10	C	3	1	10	12.5	± 10	± 12	8	6	8
10	B	6	1	10	12.5	± 10	± 12	8	6	8
10	A	8	1	10	12.5	± 10	± 15	8	6	8
15	C	2.5	1.5	15	18.7	± 10	± 12	8	6	8
15	B	5	1.5	15	18.7	± 10	± 12	8	6	8
15	A	8	1.5	15	18.7	± 10	± 15	12	8	10
22	C	1.6	2.2	22	27.5	± 10	± 12	8	6	8
22	B	5	2.2	22	27.5	± 10	± 15	8	6	8
22	A	10	2.2	22	27.5	± 10	± 15	15	10	12
33	E	1.1	3.3	33	41.2	± 10	± 12	8	6	8
33	C	2.5	3.3	33	41.2	± 10	± 12	8	6	8
33	B	4	3.3	33	41.2	± 10	± 15	8	6	8
47	E	0.9	4.7	47	58.7	± 10	± 12	8	6	8
47	C	2	4.7	47	58.7	± 10	± 15	8	6	8
47	B	2.4	4.7	47	58.7	± 10	± 15	12	8	10
68	E	1.5	6.8	68	85	± 10	± 12	8	6	8
68	C	2	6.8	68	85	± 10	± 15	8	6	8
68	B	5	6.8	68	85	± 10	± 15	15	10	12
100	E	1.2	10	100	125	± 10	± 12	10	8	10
100	C	1.7	10	100	125	± 10	± 15	10	8	10
100	B	4.0	10	100	125	± 10	± 15	22	15	18
150	E	1	15	150	187	± 10	± 15	10	8	10
150	C	2	15	150	187	± 10	± 15	15	10	12
220	E	1	22	220	275	± 10	± 15	10	8	10

为了使钽电解电容器以最稳定的质量充分发挥其性能，必须用适当的方法使用，使用前请先确认电容器的使用条件和规定的性能，必须遵守规格书上规定的所有条件。

In order to make tantalum electrolytic capacitor give full play to its performance with the most stable quality, It must be used in a proper way. Please check the condition of the capacitor before use. And specified performance, must comply with all conditions specified in the specification.

电路设计 DESIGN OF CIRCUIT

1.1 使用电压 Operating Voltage

电容器的故障受到使用电压和额定电压的比率影响很大。设计实际电路时，请考虑到所要求的可靠性适当降低电压。

The breakdown of capacitors is greatly affected by the ratio of service voltage to rated voltage. When designing a practical circuit, reduce the voltage appropriately taking into account the required reliability.

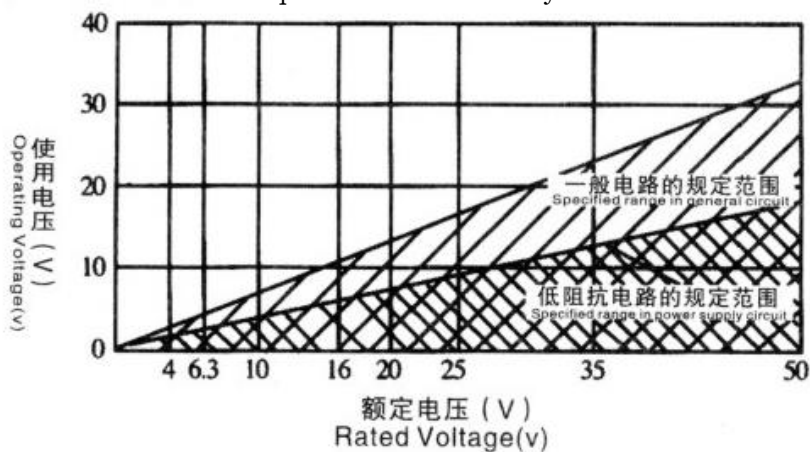

使用低阻抗电路时，请将使用电压设定在额定电压的 1/3 以下，使用其他电路时，如上图所示，请将使用电压设立在额定电压的 2/3 以下。

The breakdown of capacitors is greatly affected by the ratio of service voltage to rated voltage. When designing a practical circuit, reduce the voltage appropriately taking into account the required reliability.

低阻抗电路中并联使用时，增加直流浪涌电流失效的危险，同时注意并联电容器中储存的电荷，通过其他电容放电。

When used in parallel in low impedance circuit, it increases the risk of direct current inrush failure. Note also that the charges stored in shunt capacitors discharge through other capacitors.

在电路中，应控制瞬间大电流对电容器的冲击，建议串联电阻以缓解这种冲击。请将 $3\Omega/V$ 以上的保护电阻串联在电容器上，以限制电流在 300mA 以下，无法插入保护电阻器时，请使用额定电压的 1/3 以下的电压。

The impact of instantaneous large current on the capacitor should be controlled, and series connection is recommended. Resistance to soften the blow. Please send more than $3\Omega/V$ the protection of the resistance in series capacitance. To limit the current below 300mA on the resistor.

1.2 反向电压 Reverse voltage

钽电容器为有极性电容器，请勿施加反向电压，并不可使

用只有交流的电路。

Tantalum capacitors are polar capacitors. Do not apply reverse voltage. Use an ac only circuit.

若不得已的情况下，允许在短时间内施加小量的反向电压，其值为：

If necessary, allow a small amount of reverse current to be applied in a short period of time, whose value :

25°C 下: $\leq 10\%U_r$ 或 1V (取小者)

85°C 下: $\leq 5\%U_r$ 或 0.5V (取小者)

Under 25 °C, 10% or less U_r or 1 V (those)

Under 85 °C, 5% or less U_r or 0.5 V (those)

如果将电容器长期使用在有反向电路中时，请选用无极性电容器。

If the capacitor is used in a reverse circuit for a long time, please use the anodeless capacitor.

原则上禁止使用万用表对有钽电容器的电路或电容器本身进行不分极性的测试。

In principle, it is forbidden to use multimeters on tantalum capacitors. The body is tested regardless of polarity.

在测量使用过程中，如不慎使钽电容器承受了不应有的反向电压，请将该电容器报废，即使其各项电参数仍然合格。

In the process of measurement and use, if the tantalum capacitors are subjected to improper reverse voltage, please scrap the capacitor, even if its electrical parameters are still grid.

1.3 波纹电压 Ripple Voltage

请在电容器规定的容许波纹电压内使用。

Please use within the permissible ripple voltage of the capacitor.

使用时，直流偏压与交流分压峰值之合不得超过电容器的额定电压值。

When in use, the peak value of dc bias and ac partial voltage shall not exceed that of the capacitor. The rated voltage value of.

交流负峰值与直流偏压之合不超过电容器所允许的反向电压值。

The combination of the ac negative peak and the dc bias does not exceed the reverse allowed by the capacitor. Voltage value.

波纹电流通过钽电容器产生有用功率损耗，进而电容器自身温升导致的热击穿失效概率增大，因此有必要对通过电容器的纹波电流或电容量允许的功率损耗进行限制。

The ripple current passes through the tantalum capacitor to produce useful power loss and hence the capacitor. The probability of thermal breakdown failure due to its own temperature rise increases, so it is necessary to apply electricity. The ripple current or capacitance of the container limits the allowable power loss.

1.4 使用环境温度 Environment Temperature

请在电容器的规定使用温度范围内使用。

Please use the capacitor within the specified operating temperature range.

使用温度超过+ 85℃，请以降额电压作为使用电压。

Using the temperature more than + 85 °C , please use voltage derating voltage as.

温度特性是钽电容器的主要电气特性之一，所以当使用温度变化显著时，请在其使用温度上、下限确认电路特性，下图为代表例：

Temperature characteristic is one of the main electrical characteristics of tantalum capacitors, so when using temperature. When the temperature changes significantly, please confirm the circuit characteristics at the upper and lower limits of its operating temperature, as shown in the figure below. For example:

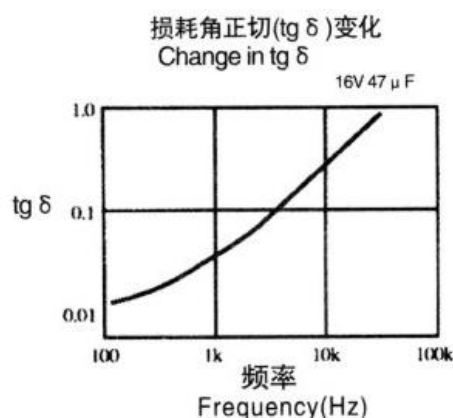
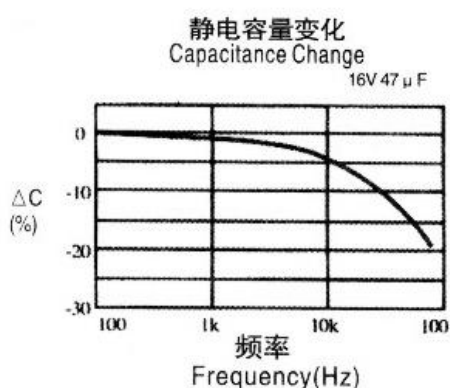

1.5 频率特性 Frequency Dependence

频率在10KHZ区域，电容器的电气特性变化显著，所以在使用高频电路上时，请确认电路特性，下图所示为代表例：

At a frequency of 10KHZ, the electrical characteristics of the capacitors change significantly, so that when using a high-frequency circuit, please confirm the circuit characteristics, as shown in the figure below:

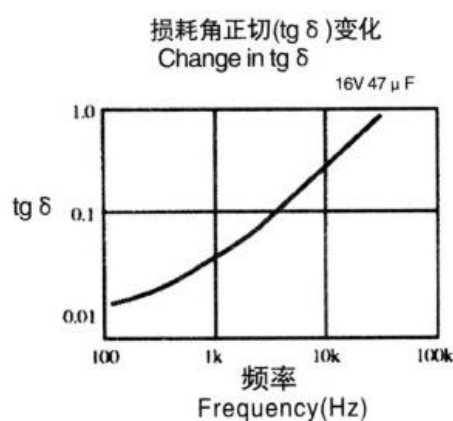
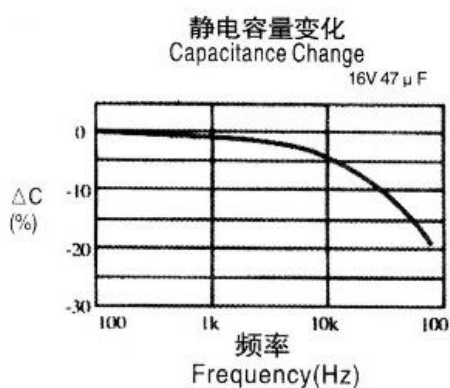

1.6 可靠性 Reliability

钽电容器的失效率根据其使用条件（环境温度、施加电压、电路电阻、使用电路等）的不同而不同，所以请在充分研讨使用条件后，选择适当产品。

The failure rate of tantalum capacitors depends on the operating conditions (ambient temperature, applied voltage, The resistance of the circuit, the use of the circuit, etc). After using the condition, select the appropriate product.

一般设计电容器时，以在+85℃下连续施加额定电压1000小时的失效率为基准，在实际电路中往往存在防止电压或电流的峰值冲击及纹波电流或其他意外电冲击的问题，所以实际使用中的降额设计师必要的，建议一般降额至65%U_R以下。

General design capacitor, at + 85 °C under continuous sinusoidal voltage rating 1000Hour failure rate is the benchmark, in the actual circuit often exists to prevent voltage or electricity Peak current shock and ripple current or other unexpected electrical shock problems, so real If necessary, it is generally recommended that the deduction be reduced to less than 65%U_R.

使用于重视安全性设备时，防止在使用中发生短路，开路等现象。因此，设计时请充分注意下列几点，确保安全。

When it is used to attach importance to safety equipment, it can prevent short circuit and open in use Road and so on. Therefore, please pay full attention to the following points when designing to ensure safety.

- A. 设计保护电路，保护装置，系统使用，确保安全性
- A. Design protective circuits, protective devices and systems to ensure safety
- B. 设计旁路电路等，使之成为一个即使发生单一故障时，也不导致整个设备故障的系统
- B. Design side circuits, etc., to make it a single failure even if

安装 CAPACITOR MOUNTING PRECAUTIONS

将电容器安装在印刷电路板上时，如受到过大的机械冲击或热冲击等负荷，将引起电气特性恶化、短路等，故请在确认实际安装条件后在使用。

When a capacitor is mounted on a printed circuit board, it is subjected to excessive mechanical shock Load, such as shock or thermal shock, will cause deterioration of electrical characteristics, short circuit, etc., so please Confirm the actual installation conditions before use.

2.1 使用、测量 Processing and Measurement

请注意使用时不要施加过大的外力，使电容器的本体或引线端子的电镀剥落受伤。

Please be careful not to apply too much external force when using to make the capacitor body or The electroplating of the lead terminal was injured.

落下或曾安装过一次的电容器请勿再次使用。

Do not reuse dropped or installed capacitors.

安装后，请勿加工电容器或弯折端子等。

After installation, do not process capacitors or bend terminals.

电容器的引线（包括片式钽电容引出端）。在测量、使用过程中请注意避免与赤手直接接触，以免汗渍，油渍等污染引起可焊性不良。

The lead wire of the capacitor (including the lead end of the chip tantalum capacitor),. In the measurement, Please pay attention to avoid direct contact with bare hands to avoid sweat and oil stains Pollution causes poor weldability.

2.2 电路板清洗 Circuit Board Cleaning

清洗时请在除去焊接时使用的焊剂的同时，迅速降去酸、碱等，不可使其残留，清洗时温度就在50℃以下，超声波，蒸汽浸渍等合计时间应在5分钟以内。

When cleaning, remove the flux used in welding and remove the acid quickly. Alkali, etc., shall not make its residual, cleaning temperature under 50 °C, and ultrasound, steamed. The total time of steam immersion should be less than 5 minutes.

2.3 用烙铁焊接时 In case of soldering by soldering iron

使用烙铁时，烙铁尖端的温度在350℃以下，使用时间应在4秒以内，并注意烙铁尖不要碰到电容器本体。

Using a soldering iron, soldering iron tip temperature under 350 °C, time should be within 4 seconds, and pay attention to soldering tip do not touch the capacitor body.

2.4 片式产品焊接 In case of chip type soldering

无论是手工焊还是再流焊，都应避免使用活性高、酸性强的助焊剂，以免清洗不净后渗透、腐蚀和扩散，而影响其可靠性。根据电路板和各类、大小、元件的包装密封度的不同，对元件施加的温度也不同。片式钽电容可使用射流法或反射法，但请在下列条件下使用：

Both manual welding and reflow welding, should avoid the use of high activity, strong acid flux, so as not to clean after transparent, corrosion and diffusion, and affect its reliability. According to the circuit board and various types, size, components of the packaging sealing different, right the temperature applied by the element is also different. Chip tantalum capacitors can be used by jet or reflection method, However, please use it under the following conditions:

波峰焊法（焊锡浸渍法） Wave soldering (soldering dip): 用粘接剂将元件固定在电路上，并将元件直接浸渍在焊接锅中。Fix the element to the circuit with adhesive and dip the element directly into the solder pot.

注意事项 Matters needing attention: 如元件的安装密度过高，可焊性将降低。故请注意放气。预热应在160℃以下，2分钟以内，焊接后请慢慢冷却。

If the mounting density of the component is too high, the weldability will be reduced. Therefore, please pay attention to the vent. Preheating shall be under 160 °C, 2 minutes, please slowly cooling after welding.

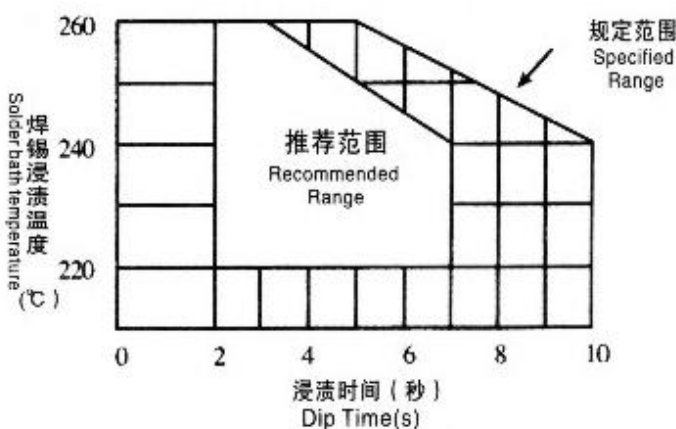

再流焊法（气氛加热法） REFLOW METHOD

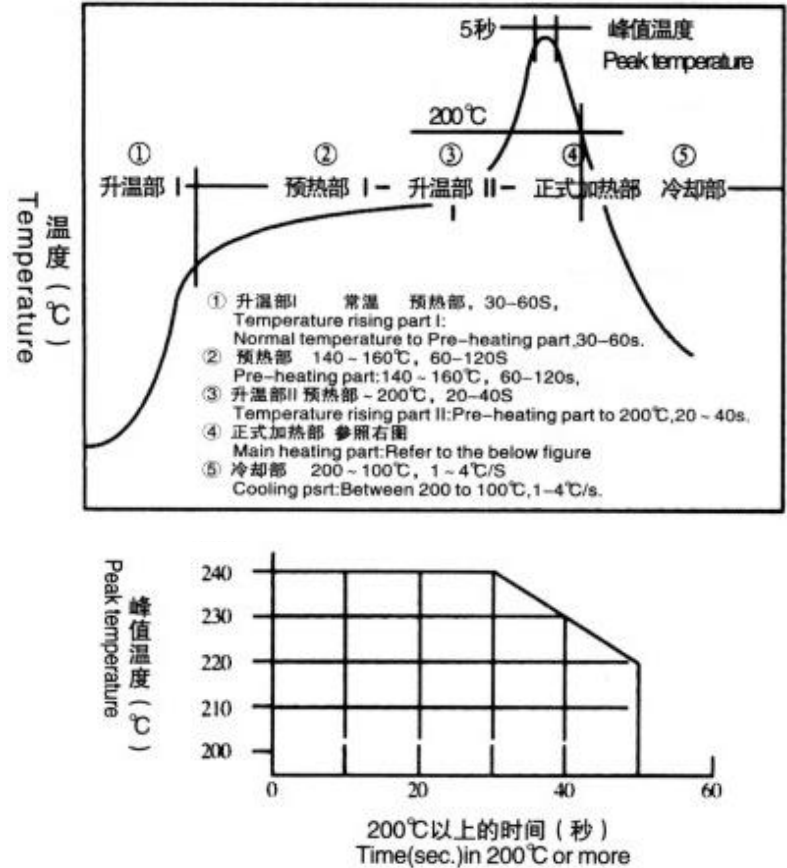

使用热源接触法（热板法）或汽相焊接法等其他方法进行焊接时，请确定确定并商谈。如焊盘比端子面大得过多，焊锡融化时可能引起错位。

Use other methods such as heat source contact (hot plate) or vapor welding. When welding, please confirm and negotiate. If the solder pad is much larger than the terminal face, the solder melt may cause dislocation.

使用 IN USING

2.2 使用环境 Circuit Board Cleaning

请勿在一下环境中使用：

Do not use in the following environment:

电容器直接接触水、卤水、油等环境。

The capacitor is in direct contact with water, brine and oil.

阳光直射电容器的环境。

Direct sunlight capacitor environment.

处于高温、高湿状态，电容器表面发生结露的环境。

At high temperature and high humidity, condensation occurs on the surface of the capacitor.

电容器接触各种活性气体的环境。

The environment in which the capacitor is exposed to various reactive gases.

有酸或碱的环境。

An acid or base environment.

有高频波诱导的环境。

High frequency wave induced environment.

有过度震动或冲击的环境。

An environment with excessive vibration or shock.