

**Description**

The HSBA6076 is the high cell density SGT N-ch MOSFETs, which provide excellent R<sub>DS(on)</sub> and gate charge for most of the synchronous buck converter applications.

The HSBA6076 meet the RoHS and Green Product requirement, 100% EAS guaranteed with full function reliability approved.

- Motor Control
- 100% EAS Guaranteed
- DC/DC Converter.
- Excellent CdV/dt effect decline
- Synchronous rectifier applications.

**Product Summary**

V <sub>DS</sub>	60	V
R <sub>DS(ON),typ</sub>	1.6	mΩ
I <sub>D</sub>	150	A

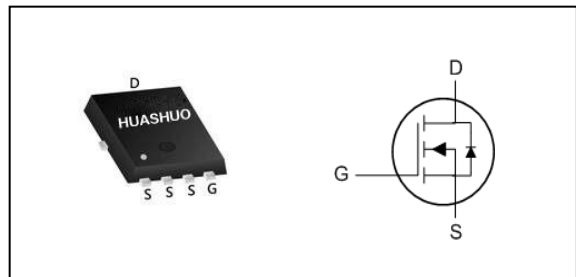
**PRPAK5X6 Pin Configuration**

**Absolute Maximum Ratings**

Symbol	Parameter	Rating	Units
V <sub>DS</sub>	Drain-Source Voltage	60	V
V <sub>GS</sub>	Gate-Source Voltage	±20	V
I <sub>D</sub> @T <sub>C</sub> =25°C	Continuous Drain Current <sup>1,6</sup>	150	A
I <sub>D</sub> @T <sub>C</sub> =100°C	Continuous Drain Current <sup>1,6</sup>	90	A
I <sub>DM</sub>	Pulsed Drain Current <sup>2</sup>	600	A
EAS	Single Pulse Avalanche Energy <sup>3</sup>	430	mJ
I <sub>AS</sub>	Avalanche Current	90	A
P <sub>D</sub> @T <sub>C</sub> =25°C	Total Power Dissipation <sup>4</sup>	110	W
T <sub>STG</sub>	Storage Temperature Range	-55 to 150	°C
T <sub>J</sub>	Operating Junction Temperature Range	-55 to 150	°C

**Thermal Data**

Symbol	Parameter	Typ.	Max.	Unit
R <sub>θJA</sub>	Thermal Resistance Junction-Ambient <sup>1</sup>	---	60	°C/W
R <sub>θJC</sub>	Thermal Resistance Junction-Case <sup>1</sup>	---	1.1	°C/W

**N-Ch 60V Fast Switching MOSFETs**
**Electrical Characteristics ( $T_J=25\text{ }^\circ\text{C}$ , unless otherwise noted)**

Symbol	Parameter	Conditions	Min.	Typ.	Max.	Unit
$BV_{DSS}$	Drain-Source Breakdown Voltage	$V_{GS}=0V, I_D=250\mu A$	60	---	---	V
$R_{DS(ON)}$	Static Drain-Source On-Resistance <sup>2</sup>	$V_{GS}=10V, I_D=20A$	---	1.6	2.0	$m\Omega$
		$V_{GS}=4.5V, I_D=20A$	---	2.3	3.0	$m\Omega$
$V_{GS(th)}$	Gate Threshold Voltage	$V_{GS}=V_{DS}, I_D=250\mu A$	1.2	---	2.5	V
$I_{DSS}$	Drain-Source Leakage Current	$V_{DS}=52V, V_{GS}=0V, T_J=25^\circ C$	---	---	1	$\mu A$
		$V_{DS}=52V, V_{GS}=0V, T_J=55^\circ C$	---	---	5	$\mu A$
$I_{GSS}$	Gate-Source Leakage Current	$V_{GS}=\pm 20V, V_{DS}=0V$	---	---	$\pm 100$	nA
$g_{fs}$	Forward Transconductance	$V_{DS}=5V, I_D=20A$	---	18	---	S
$R_g$	Gate Resistance	$V_{DS}=0V, V_{GS}=0V, f=1MHz$	---	1.1	---	$\Omega$
$Q_g$	Total Gate Charge (10V)	$V_{DS}=30V, V_{GS}=10V, I_D=20A$	---	105	---	nC
$Q_{gs}$	Gate-Source Charge		---	26	---	
$Q_{gd}$	Gate-Drain Charge		---	27	---	
$T_{d(on)}$	Turn-On Delay Time	$V_{DD}=30V, V_{GS}=10V, R_G=3\Omega, I_D=20A$	---	19	---	ns
$T_r$	Rise Time		---	12	---	
$T_{d(off)}$	Turn-Off Delay Time		---	66	---	
$T_f$	Fall Time		---	119	---	
$C_{iss}$	Input Capacitance	$V_{DS}=30V, V_{GS}=0V, f=1MHz$	---	5980	---	pF
$C_{oss}$	Output Capacitance		---	2822	---	
$C_{rss}$	Reverse Transfer Capacitance		---	28	---	

**Diode Characteristics**

Symbol	Parameter	Conditions	Min.	Typ.	Max.	Unit
$I_S$	Continuous Source Current <sup>1,5</sup>	$V_G=V_D=0V$ , Force Current	---	---	150	A
$V_{SD}$	Diode Forward Voltage <sup>2</sup>	$V_{GS}=0V, I_S=1A, T_J=25^\circ C$	---	---	1.0	V

Note :

- 1.The data tested by surface mounted on a 1 inch<sup>2</sup> FR-4 board with 2OZ copper.
- 2.The data tested by pulsed , pulse width  $\leq 300\mu s$  , duty cycle  $\leq 2\%$
- 3.The EAS data shows Max. rating . The test condition is  $V_{DD}=50V, V_{GS}=10V, L=0.5mH, I_{AS}=90A$
- 4.The power dissipation is limited by  $150^\circ C$  junction temperature
- 5.The data is theoretically the same as  $I_D$  and  $I_{DM}$  , in real applications , should be limited by total power dissipation.
- 6.The maximum current rating is package limited.

**N-Ch 60V Fast Switching MOSFETs**

**Typical Characteristics**

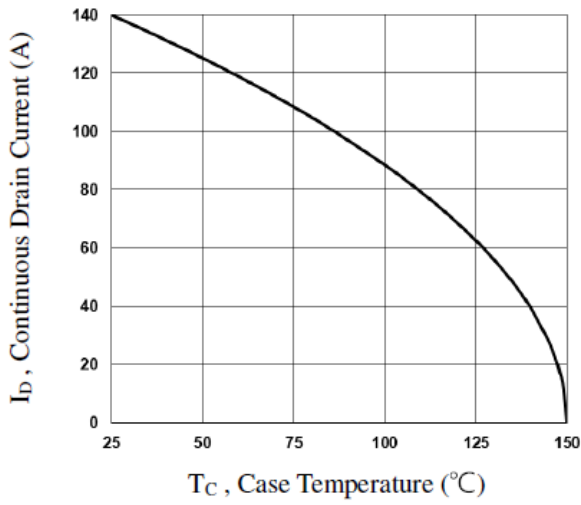

**Fig.1 Continuous Drain Current vs. TC**

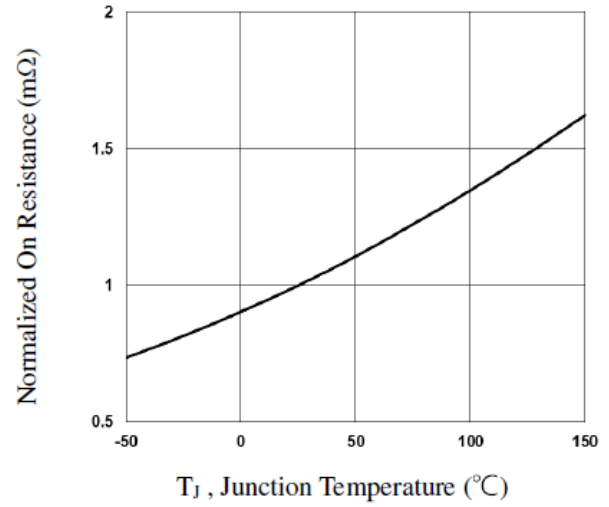

**Fig.2 Normalized RDSON vs. TJ**

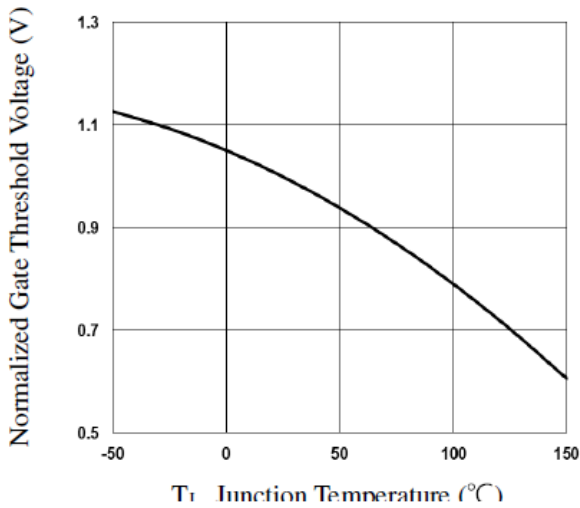

**Fig.3 Normalized Vth vs. Tj**

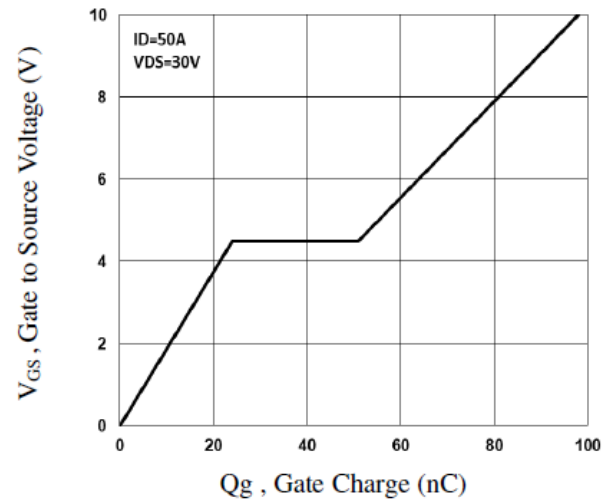

**Fig.4 Gate-Charge Characteristics**

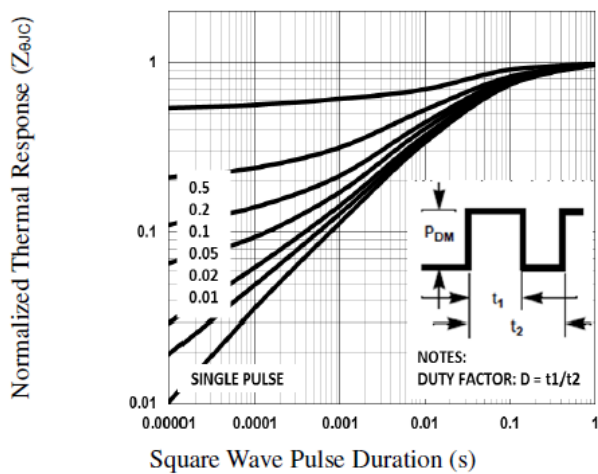

**Fig.5 Normalized Transient Impedance**

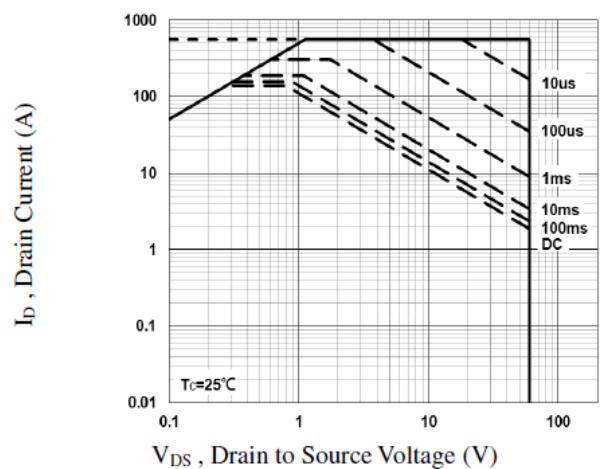

**Fig.6 Maximum Safe Operation Area**

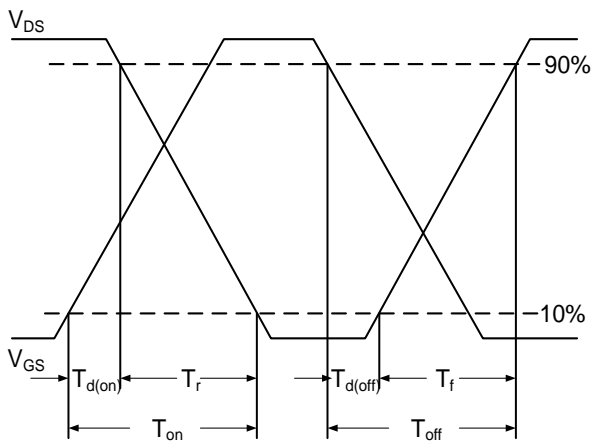

**Fig.7 Switching Time Waveform**

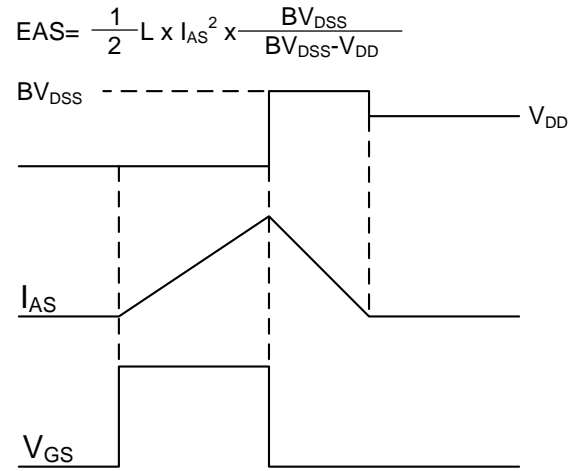

**Fig.8 Unclamped Inductive Switching Waveform**

## Ordering Information

Part Number	Package code	Packaging
HSBA6076	PRPAK5*6	3000/Tape&Reel

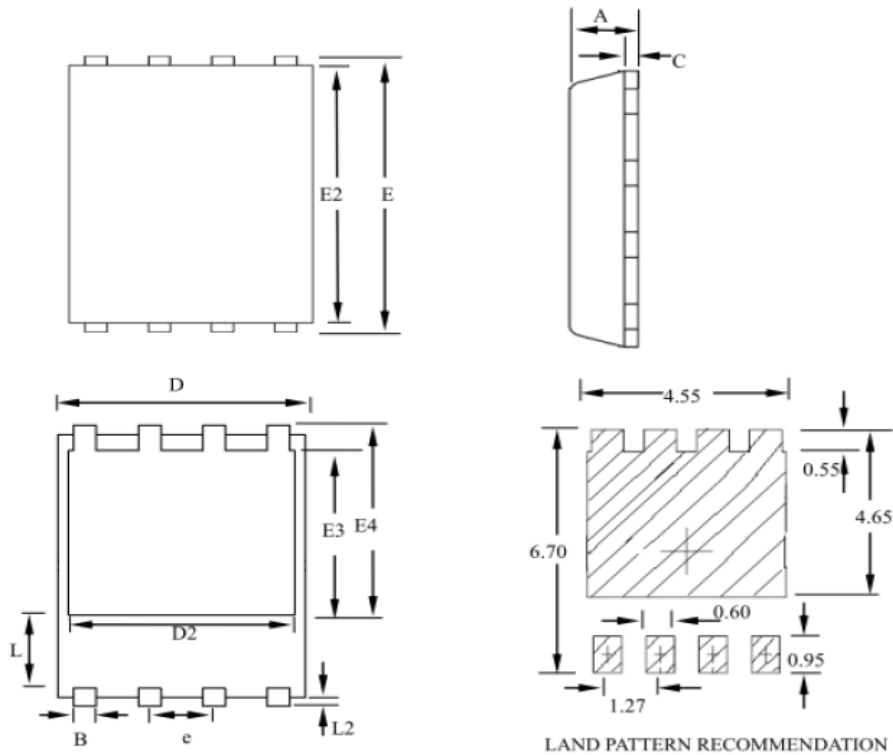

SYMBOLS	MILLIMETERS			INCHES		
	MIN	NOM	MAX	MIN	NOM	MAX
A	0.80	--	1.20	0.031	--	0.047
B	0.30	--	0.51	0.012	--	0.020
C	0.15	--	0.35	0.006	--	0.014
D	4.80	--	5.30	0.189	--	0.209
D2	3.61	--	4.35	0.142	--	0.171
E	5.90	--	6.35	0.232	--	0.250
E2	5.42	--	5.90	0.213	--	0.232
E3	3.23	--	3.90	0.127	--	0.154
E4	3.69	--	4.55	0.145	--	0.179
L	0.61	--	1.80	0.024	--	0.071
L2	0.05	--	0.36	0.002	--	0.014
e	--	1.27	--	--	0.050	--