

# TLV2422, TLV2422A, TLV2422Y Advanced LinCMOS™ RAIL-TO-RAIL OUTPUT WIDE-INPUT-VOLTAGE MICROPOWER DUAL OPERATIONAL AMPLIFIERS

SLOS199C – SEPTEMBER 1997 – REVISED APRIL 2001

- Output Swing Includes Both Supply Rails
- Extended Common-Mode Input Voltage Range . . . 0 V to 4.5 V (Min) With 5-V Single Supply
- No Phase Inversion
- Low Noise . . . 18 nV/√Hz Typ at f = 1 kHz
- Low Input Offset Voltage  
950 μV Max at T<sub>A</sub> = 25°C (TLV2422A)
- Low Input Bias Current . . . 1 pA Typ
- Micropower Operation . . . 50 μA Per Channel
- 600-Ω Output Drive
- Available in Q-Temp Automotive  
HighRel Automotive Applications  
Configuration Control / Print Support  
Qualification to Automotive Standards

## description

The TLV2422 and TLV2422A are dual low-voltage operational amplifiers from Texas Instruments. The common-mode input voltage range for this device has been extended over the typical CMOS amplifiers making them suitable for a wide range of applications. In addition, the devices do not phase invert when the common-mode input is driven to the supply rails. This satisfies most design requirements without paying a premium for rail-to-rail input performance. They also exhibit rail-to-rail output performance for increased dynamic range in single- or split-supply applications. This family is fully characterized at 3-V and 5-V supplies and is optimized for low-voltage operation. The TLV2422 only requires 50 μA of supply current per channel, making it ideal for battery-powered applications. The TLV2422 also has increased output drive over previous rail-to-rail operational amplifiers and can drive 600-Ω loads for telecom applications.

Other members in the TLV2422 family are the high-power, TLV2442, and low-power, TLV2432, versions.

The TLV2422, exhibiting high input impedance and low noise, is excellent for small-signal conditioning for high-impedance sources, such as piezoelectric transducers. Because of the micropower dissipation levels and low-voltage operation, these devices work well in hand-held monitoring and remote-sensing applications. In addition, the rail-to-rail output feature with single- or split-supplies makes this family a great choice when interfacing with analog-to-digital converters (ADCs). For precision applications, the TLV2422A is available with a maximum input offset voltage of 950 μV.

If the design requires single operational amplifiers, see the TI TLV2211/21/31. This is a family of rail-to-rail output operational amplifiers in the SOT-23 package. Their small size and low power consumption, make them ideal for high density, battery-powered equipment.

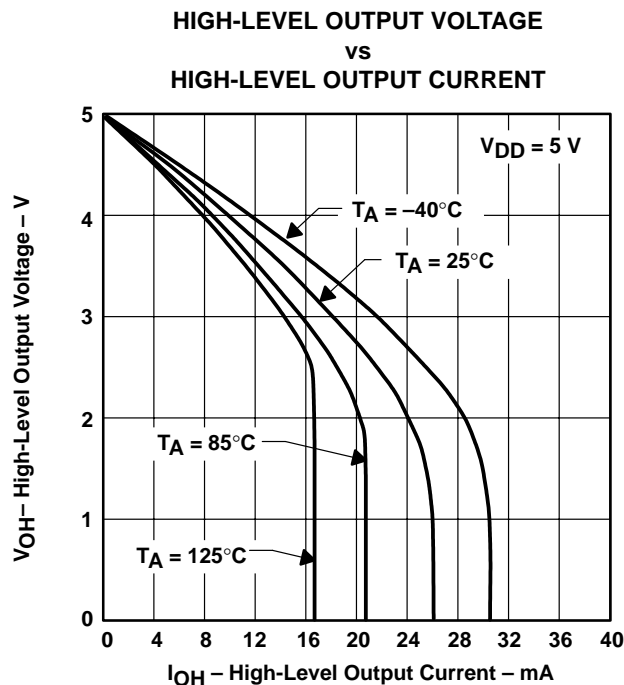


Figure 1



Please be aware that an important notice concerning availability, standard warranty, and use in critical applications of Texas Instruments semiconductor products and disclaimers thereto appears at the end of this data sheet.

Advanced LinCMOS is a trademark of Texas Instruments.

PRODUCTION DATA information is current as of publication date. Products conform to specifications per the terms of Texas Instruments standard warranty. Production processing does not necessarily include testing of all parameters.

 **TEXAS  
INSTRUMENTS**

POST OFFICE BOX 655303 • DALLAS, TEXAS 75265

Copyright © 2001, Texas Instruments Incorporated  
On products compliant to MIL-PRF-38535, all parameters are tested unless otherwise noted. On all other products, production processing does not necessarily include testing of all parameters.

# TLV2422, TLV2422A, TLV2422Y

## Advanced LinCMOS™ RAIL-TO-RAIL OUTPUT

### WIDE-INPUT-VOLTAGE MICROPOWER DUAL OPERATIONAL AMPLIFIERS

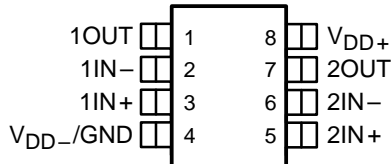
SLOS199C – SEPTEMBER 1997 – REVISED APRIL 2001

#### AVAILABLE OPTIONS

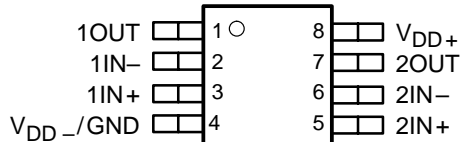
T <sub>A</sub>	V <sub>IO</sub> max AT 25°C	PACKAGED DEVICES					CHIP FORM (Y)
		SMALL OUTLINE (D)	CHIP CARRIER (FK)	CERAMIC DIP (JG)	TSSOP (PW)	CERAMIC FLAT PACK (U)	
0°C to 70°C	2.5 mV	TLV2422CD	—	—	TLV2422CPWLE	—	TLV2422Y
–40°C to 85°C	950 μV 2.5 mV	TLV2422AID TLV2422ID	— —	— —	TLV2422AIPWLE —	— —	
–40°C to 125°C	950 μV 2.5 mV	TLV2422AQD TLV2422QD	— —	— —	— —	— —	
–55°C to 125°C	950 μV 2 mV	— —	TLV2422AMFK TLV2422MFK	TLV2422AMJG TLV2422MJG	— —	TLV2422AMU TLV2422MU	

The D packages are available taped and reeled. Add R suffix to device type (e.g., TLV2422CDR). The PW package is available only left-end taped and reeled. Chips are tested at 25°C.

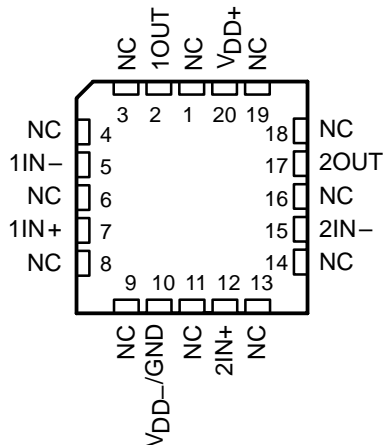
**D OR JG PACKAGE  
(TOP VIEW)**



**PW PACKAGE  
(TOP VIEW)**

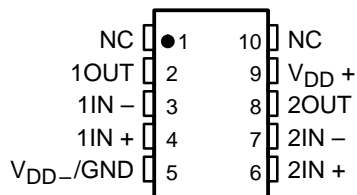


**FK PACKAGE  
(TOP VIEW)**

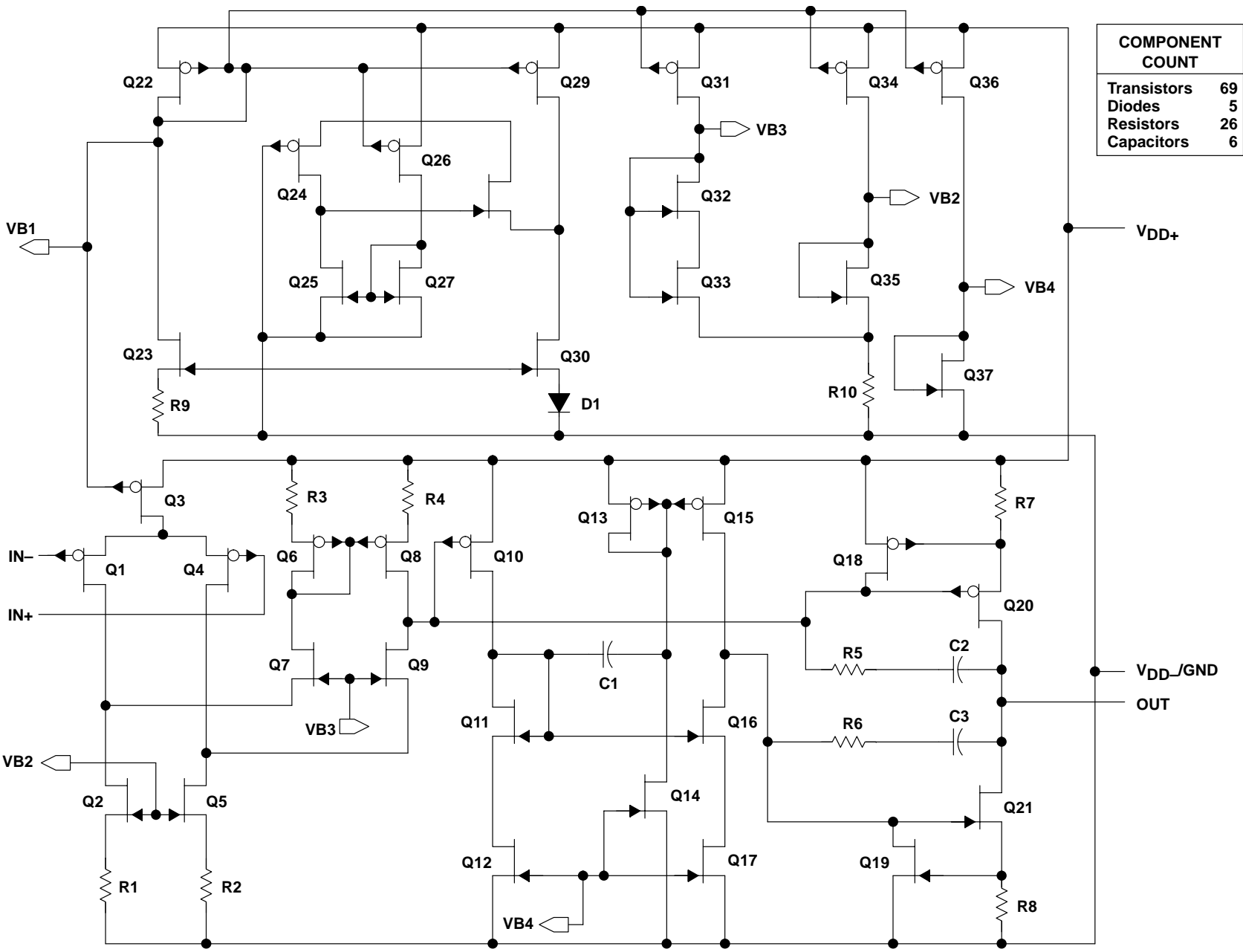


NC – No internal connection

**U PACKAGE  
(TOP VIEW)**



equivalent schematic (each amplifier)



COMPONENT COUNT	
Transistors	69
Diodes	5
Resistors	26
Capacitors	6

**absolute maximum ratings over operating free-air temperature range (unless otherwise noted)†**

Supply voltage, $V_{DD}$ (see Note 1)	12 V
Differential input voltage, $V_{ID}$ (see Note 2)	$\pm V_{DD}$
Input voltage, $V_I$ (any input, see Note 1): C and I suffix	-0.3 V to $V_{DD}$
Input current, $I_I$ (each input)	$\pm 5$ mA
Output current, $I_O$	$\pm 50$ mA
Total current into $V_{DD+}$	$\pm 50$ mA
Total current out of $V_{DD-}$	$\pm 50$ mA
Duration of short-circuit current at (or below) 25°C (see Note 3)	unlimited
Continuous total power dissipation	See Dissipation Rating Table
Operating free-air temperature range, $T_A$ : C suffix	0°C to 70°C
I suffix	-40°C to 85°C
Q suffix	-40°C to 125°C
M suffix	-55°C to 125°C
Storage temperature range, $T_{stg}$	-65°C to 150°C
Lead temperature 1,6 mm (1/16 inch) from case for 10 seconds	260°C

† Stresses beyond those listed under “absolute maximum ratings” may cause permanent damage to the device. These are stress ratings only, and functional operation of the device at these or any other conditions beyond those indicated under “recommended operating conditions” is not implied. Exposure to absolute-maximum-rated conditions for extended periods may affect device reliability.

- NOTES: 1. All voltage values, except differential voltages, are with respect to the midpoint between  $V_{DD+}$  and  $V_{DD-}$ .  
 2. Differential voltages are at  $IN+$  with respect to  $IN-$ . Excessive current flows if input is brought below  $V_{DD-} - 0.3$  V.  
 3. The output may be shorted to either supply. Temperature and/or supply voltages must be limited to ensure that the maximum dissipation rating is not exceeded.

DISSIPATION RATING TABLE

PACKAGE	$T_A \leq 25^\circ\text{C}$ POWER RATING	DERATING FACTOR ABOVE $T_A = 25^\circ\text{C}$	$T_A = 70^\circ\text{C}$ POWER RATING	$T_A = 85^\circ\text{C}$ POWER RATING	$T_A = 125^\circ\text{C}$ POWER RATING
D	725 mW	5.8 mW/°C	464 mW	377 mW	145 mW
FK	1375 mW	11.0 mW/°C	880 mW	715 mW	275 mW
JG	1050 mW	8.4 mW/°C	672 mW	546 mW	210 mW
PW	525 mW	4.2 mW/°C	336 mW	273 mW	105 mW
U	675 mW	5.4 mW/°C	432 mW	350 mW	135 mW

**recommended operating conditions**

	C SUFFIX		I SUFFIX		Q SUFFIX		M SUFFIX		UNIT
	MIN	MAX	MIN	MAX	MIN	MAX	MIN	MAX	
Supply voltage, $V_{DD\pm}$	2.7	10	2.7	10	2.7	10	2.7	10	V
Input voltage range, $V_I$	$V_{DD-}$	$V_{DD+} - 0.8$	$V_{DD-}$	$V_{DD+} - 0.8$	$V_{DD-}$	$V_{DD+} - 0.8$	$V_{DD-}$	$V_{DD+} - 0.8$	V
Common-mode input voltage, $V_{IC}$	$V_{DD-}$	$V_{DD+} - 0.8$	$V_{DD-}$	$V_{DD+} - 0.8$	$V_{DD-}$	$V_{DD+} - 0.8$	$V_{DD-}$	$V_{DD+} - 0.8$	V
Operating free-air temperature, $T_A$	0	70	-40	85	-40	125	-55	125	°C



**TLV2422, TLV2422A**  
**Advanced LinCMOS™ RAIL-TO-RAIL OUTPUT**  
**WIDE-INPUT-VOLTAGE MICROPOWER DUAL OPERATIONAL AMPLIFIERS**

SLOS199C – SEPTEMBER 1997 – REVISED APRIL 2001

**electrical characteristics at specified free-air temperature,  $V_{DD} = 3\text{ V}$  (unless otherwise noted)**

PARAMETER	TEST CONDITIONS	$T_A$ †	TLV2422C			UNIT
			MIN	TYP	MAX	
$V_{IO}$ Input offset voltage	$V_{IC} = 0,$ $V_O = 0,$ $V_{DD} \pm = \pm 2.5\text{ V},$ $R_S = 50\ \Omega$	25°C	300	2000	$\mu\text{V}$	
		Full range	2500			
$\alpha_{VIO}$ Temperature coefficient of input offset voltage		25°C to 70°C	2		$\mu\text{V}/^\circ\text{C}$	
Input offset voltage long-term drift (see Note 4)		25°C	0.003		$\mu\text{V}/\text{mo}$	
$I_{IO}$ Input offset current		25°C	0.5	60	$\text{pA}$	
		Full range	150			
$I_{IB}$ Input bias current		25°C	1	60	$\text{pA}$	
		Full range	150			
$V_{ICR}$ Common-mode input voltage range		$ V_{IO}  \leq 5\text{ mV},$ $R_S = 50\ \Omega$	25°C	0 to 2.5	-0.25 to 2.75	$\text{V}$
			Full range	0 to 2.2		
$V_{OH}$ High-level output voltage	$I_{OH} = -100\ \mu\text{A}$	25°C	2.97		$\text{V}$	
		25°C	2.75			
		Full range	2.5			
$V_{OL}$ Low-level output voltage	$V_{IC} = 0,$ $I_{OL} = 100\ \mu\text{A}$	25°C	0.05		$\text{V}$	
		25°C	0.2			
		Full range	0.5			
$A_{VD}$ Large-signal differential voltage amplification	$V_{IC} = 2.5\text{ V},$ $V_O = 1\text{ V to }2\text{ V}$	25°C	$R_L = 10\ \text{k}\Omega^\ddagger$		$\text{V/mV}$	
			6 10			
		Full range	3			
$r_{i(d)}$ Differential input resistance		25°C	$R_L = 1\ \text{M}\Omega^\ddagger$		$\Omega$	
			700			
$r_{i(c)}$ Common-mode input resistance		25°C	$10^{12}$		$\Omega$	
$c_{i(c)}$ Common-mode input capacitance	$f = 10\ \text{kHz}$	25°C	8		$\text{pF}$	
$z_o$ Closed-loop output impedance	$f = 100\ \text{kHz},$ $A_V = 10$	25°C	130		$\Omega$	
CMRR Common-mode rejection ratio	$V_{IC} = 0\text{ to }2.5\text{ V},$ $V_O = 1.5\text{ V},$ $R_S = 50\ \Omega$	25°C	70	83	$\text{dB}$	
		Full range	70			
$k_{SVR}$ Supply-voltage rejection ratio ( $\Delta V_{DD}/\Delta V_{IO}$ )	$V_{DD} = 2.7\text{ V to }8\text{ V},$ $V_{IC} = V_{DD}/2,$ No load	25°C	80	95	$\text{dB}$	
		Full range	80			
$I_{DD}$ Supply current	$V_O = 1.5\text{ V},$ No load	25°C	100	150	$\mu\text{A}$	
		Full range	175			

† Full range is 0°C to 70°C.

‡ Referenced to 2.5 V

NOTE 4: Typical values are based on the input offset voltage shift observed through 500 hours of operating life test at  $T_A = 150^\circ\text{C}$  extrapolated to  $T_A = 25^\circ\text{C}$  using the Arrhenius equation and assuming an activation energy of 0.96 eV.

**TLV2422, TLV2422A**  
**Advanced LinCMOS™ RAIL-TO-RAIL OUTPUT**  
**WIDE-INPUT-VOLTAGE MICROPOWER DUAL OPERATIONAL AMPLIFIERS**

SLOS199C – SEPTEMBER 1997 – REVISED APRIL 2001

**electrical characteristics at specified free-air temperature,  $V_{DD} = 3\text{ V}$  (unless otherwise noted)**

PARAMETER	TEST CONDITIONS	$T_A$ †	TLV2422I			TLV2422AI			UNIT
			MIN	TYP	MAX	MIN	TYP	MAX	
$V_{IO}$ Input offset voltage	$V_{IC} = 0, V_O = 0, V_{DD} \pm = \pm 2.5\text{ V}, R_S = 50\ \Omega$	25°C	300	2000		300	950	$\mu\text{V}$	
		Full range		2500		1500			
$\alpha_{V_{IO}}$ Temperature coefficient of input offset voltage		25°C to 70°C	2			2		$\mu\text{V}/^\circ\text{C}$	
Input offset voltage long-term drift (see Note 4)		25°C	0.003			0.003		$\mu\text{V}/\text{mo}$	
$I_{IO}$ Input offset current		25°C	0.5	60		0.5	60	pA	
		Full range		150		150			
$I_{IB}$ Input bias current	25°C	1	60		1	60	pA		
	Full range		150		150				
$V_{ICR}$ Common-mode input voltage range	$ V_{IO}  \leq 5\text{ mV}, R_S = 50\ \Omega$	25°C	0 to 2.5	-0.25 to 2.75		0 to 2.5	-0.25 to 2.75	V	
		Full range	0 to 2.2			0 to 2.2			
$V_{OH}$ High-level output voltage	$I_{OH} = -100\ \mu\text{A}$ $I_{OH} = -500\ \mu\text{A}$	25°C	2.97			2.97		V	
		25°C	2.75			2.75			
		Full range	2.5			2.5			
$V_{OL}$ Low-level output voltage	$V_{IC} = 0, I_{OL} = 100\ \mu\text{A}$ $V_{IC} = 0, I_{OL} = 250\ \mu\text{A}$	25°C	0.05			0.05		V	
		25°C	0.2			0.2			
		Full range		0.5		0.5			
$A_{VD}$ Large-signal differential voltage amplification	$V_{IC} = 2.5\text{ V}, V_O = 1\text{ V to }2\text{ V}$ $R_L = 10\text{ k}\Omega \ddagger$ $R_L = 1\text{ M}\Omega \ddagger$	25°C	6	10		6	10	V/mV	
		Full range	3			3			
		25°C	700			700			
$r_{i(d)}$ Differential input resistance		25°C	$10^{12}$			$10^{12}$	$\Omega$		
$r_{i(c)}$ Common-mode input resistance		25°C	$10^{12}$			$10^{12}$	$\Omega$		
$C_{i(c)}$ Common-mode input capacitance	$f = 10\text{ kHz}$	25°C	8			8	pF		
$z_o$ Closed-loop output impedance	$f = 100\text{ kHz}, A_V = 10$	25°C	130			130	$\Omega$		
CMRR Common-mode rejection ratio	$V_{IC} = 0\text{ to }2.5\text{ V}, V_O = 1.5\text{ V}, R_S = 50\ \Omega$	25°C	70	83		70	83	dB	
		Full range	70			70			
$k_{SVR}$ Supply-voltage rejection ratio ( $\Delta V_{DD}/\Delta V_{IO}$ )	$V_{DD} = 2.7\text{ V to }8\text{ V}, V_{IC} = V_{DD}/2, \text{ No load}$	25°C	80	95		80	95	dB	
		Full range	80			80			
$I_{DD}$ Supply current	$V_O = 1.5\text{ V}, \text{ No load}$	25°C	100	150		100	150	$\mu\text{A}$	
		Full range		175		175			

† Full range is -40°C to 85°C.

‡ Referenced to 2.5 V

NOTE 4: Typical values are based on the input offset voltage shift observed through 500 hours of operating life test at  $T_A = 150^\circ\text{C}$  extrapolated to  $T_A = 25^\circ\text{C}$  using the Arrhenius equation and assuming an activation energy of 0.96 eV.



**TLV2422, TLV2422A**  
**Advanced LinCMOS™ RAIL-TO-RAIL OUTPUT**  
**WIDE-INPUT-VOLTAGE MICROPOWER DUAL OPERATIONAL AMPLIFIERS**

SLOS199C – SEPTEMBER 1997 – REVISED APRIL 2001

operating characteristics at specified free-air temperature,  $V_{DD} = 3\text{ V}$

PARAMETER		TEST CONDITIONS		$T_A$ †	TLV2422C, TLV2422I TLV2422AI			UNIT
					MIN	TYP	MAX	
SR	Slew rate at unity gain	$V_O = 1.5\text{ V to }3.5\text{ V},$ $C_L = 100\text{ pF}‡$	$R_L = 10\text{ k}\Omega‡$	25°C	0.01	0.02	$\text{V}/\mu\text{s}$	
				Full range	0.008			
$V_n$	Equivalent input noise voltage	$f = 10\text{ Hz}$		25°C	100		$\text{nV}/\sqrt{\text{Hz}}$	
		$f = 1\text{ kHz}$		25°C	23			
$V_{N(PP)}$	Peak-to-peak equivalent input noise voltage	$f = 0.1\text{ Hz to }1\text{ Hz}$		25°C	2.7		$\mu\text{V}$	
		$f = 0.1\text{ Hz to }10\text{ Hz}$		25°C	4			
$I_n$	Equivalent input noise current			25°C	0.6		$\text{fA}/\sqrt{\text{Hz}}$	
THD + N	Total harmonic distortion plus noise	$V_O = 0.5\text{ V to }2.5\text{ V},$ $f = 1\text{ kHz},$ $R_L = 10\text{ k}\Omega‡$		25°C	$A_V = 1$	0.25%		
					$A_V = 10$	1.8%		
	Gain-bandwidth product	$f = 10\text{ kHz},$ $C_L = 100\text{ pF}‡$	$R_L = 10\text{ k}\Omega‡$	25°C	46		$\text{kHz}$	
BOM	Maximum output-swing bandwidth	$V_{O(PP)} = 1\text{ V},$ $R_L = 10\text{ k}\Omega‡$	$A_V = 1,$ $C_L = 100\text{ pF}‡$	25°C	8.3		$\text{kHz}$	
$t_s$	Settling time	$A_V = -1,$ Step = $0.5\text{ V to }2.5\text{ V},$ $R_L = 10\text{ k}\Omega‡$ $C_L = 100\text{ pF}‡$		25°C	To 0.1%	8.6		$\mu\text{s}$
					To 0.01%	16		
$\phi_m$	Phase margin at unity gain	$R_L = 10\text{ k}\Omega‡$	$C_L = 100\text{ pF}‡$	25°C	62°			
	Gain margin			25°C	11			$\text{dB}$

† Full range for the C version is 0°C to 70°C. Full range for the I version is –40°C to 85°C.

‡ Referenced to 2.5 V

**TLV2422, TLV2422A**  
**Advanced LinCMOS™ RAIL-TO-RAIL OUTPUT**  
**WIDE-INPUT-VOLTAGE MICROPOWER DUAL OPERATIONAL AMPLIFIERS**

SLOS199C – SEPTEMBER 1997 – REVISED APRIL 2001

**electrical characteristics at specified free-air temperature,  $V_{DD} = 3\text{ V}$  (unless otherwise noted)**

PARAMETER	TEST CONDITIONS	$T_A$ †	TLV2422Q, TLV2422M			TLV2422AQ, TLV2422AM			UNIT
			MIN	TYP	MAX	MIN	TYP	MAX	
$V_{IO}$ Input offset voltage	$V_{IC} = 0,$ $V_O = 0,$ $V_{DD} \pm = \pm 1.5\text{ V},$ $R_S = 50\ \Omega$	25°C	300	2000		300	950	$\mu\text{V}$	
		Full range		2500		1800			
$\alpha_{V_{IO}}$ Temperature coefficient of input offset voltage		Full range	2			2		$\mu\text{V}/^\circ\text{C}$	
Input offset voltage long-term drift (see Note 4)		25°C	0.003			0.003		$\mu\text{V}/\text{mo}$	
$I_{IO}$ Input offset current		25°C	0.5	60		0.5	60	$\text{pA}$	
		Full range		150		150			
$I_{IB}$ Input bias current	25°C	1	60		1	60	$\text{pA}$		
	Full range		300		300				
$V_{ICR}$ Common-mode input voltage range	$ V_{IO}  \leq 5\text{ mV},$ $R_S = 50\ \Omega$	25°C	0 to 2.5	-0.25 to 2.75		0 to 2.5	-0.25 to 2.75	$\text{V}$	
		Full range	0 to 2.2			0 to 2.2			
$V_{OH}$ High-level output voltage	$I_{OH} = -100\ \mu\text{A}$ $I_{OH} = -500\ \mu\text{A}$	25°C	2.97			2.97		$\text{V}$	
		25°C	2.75			2.75			
		Full range	2.5			2.5			
$V_{OL}$ Low-level output voltage	$V_{IC} = 0,$ $I_{OL} = 100\ \mu\text{A}$ $V_{IC} = 0,$ $I_{OL} = 250\ \mu\text{A}$	25°C	0.05			0.05		$\text{V}$	
		25°C	0.2			0.2			
		Full range		0.5		0.5			
$A_{VD}$ Large-signal differential voltage amplification	$V_{IC} = 1.5\text{ V},$ $V_O = 1\text{ V to } 2\text{ V}$	25°C	6	10		6	10	$\text{V}/\text{mV}$	
			Full range	2			2		
		25°C	700			700			
$r_{i(d)}$ Differential input resistance		25°C	$10^{12}$			$10^{12}$	$\Omega$		
$r_{i(c)}$ Common-mode input resistance		25°C	$10^{12}$			$10^{12}$	$\Omega$		
$C_{i(c)}$ Common-mode input capacitance	$f = 10\text{ kHz}$	25°C	8			8	$\text{pF}$		
$z_o$ Closed-loop output impedance	$f = 100\text{ kHz},$ $A_V = 10$	25°C	130			130	$\Omega$		
CMRR Common-mode rejection ratio	$V_{IC} = V_{ICR}\text{ min},$ $V_O = 1.5\text{ V},$ $R_S = 50\ \Omega$	25°C	70	83		70	83	$\text{dB}$	
		Full range	70			70			
kSVR Supply-voltage rejection ratio ( $\Delta V_{DD}/\Delta V_{IO}$ )	$V_{DD} = 2.7\text{ V to } 8\text{ V},$ $V_{IC} = V_{DD}/2,$ No load	25°C	80	95		80	95	$\text{dB}$	
		Full range	80			80			
$I_{DD}$ Supply current	$V_O = 1.5\text{ V},$ No load	25°C	100	150		100	150	$\mu\text{A}$	
		Full range		175		175			

† Full range is  $-40^\circ\text{C}$  to  $125^\circ\text{C}$  for Q level part,  $-55^\circ\text{C}$  to  $125^\circ\text{C}$  for M level part.

‡ Referenced to 1.5 V

NOTE 4: Typical values are based on the input offset voltage shift observed through 500 hours of operating life test at  $T_A = 150^\circ\text{C}$  extrapolated to  $T_A = 25^\circ\text{C}$  using the Arrhenius equation and assuming an activation energy of 0.96 eV.





**TLV2422, TLV2422A**  
**Advanced LinCMOS™ RAIL-TO-RAIL OUTPUT**  
**WIDE-INPUT-VOLTAGE MICROPOWER DUAL OPERATIONAL AMPLIFIERS**

SLOS199C – SEPTEMBER 1997 – REVISED APRIL 2001

operating characteristics at specified free-air temperature,  $V_{DD} = 3\text{ V}$

PARAMETER	TEST CONDITIONS	$T_A$ †	TLV2422Q, TLV2422M, TLV2422AQ, TLV2422AM			UNIT
			MIN	TYP	MAX	
SR Slew rate at unity gain	$V_O = 1.1\text{ V to }1.9\text{ V},$ $R_L = 10\text{ k}\Omega\ddagger,$ $C_L = 100\text{ pF}\ddagger$	25°C	0.01	0.02		V/ $\mu\text{s}$
		Full range	0.008			
$V_n$ Equivalent input noise voltage	$f = 10\text{ Hz}$	25°C	100		nV/ $\sqrt{\text{Hz}}$	
	$f = 1\text{ kHz}$	25°C	23			
$V_{N(PP)}$ Peak-to-peak equivalent input noise voltage	$f = 0.1\text{ Hz to }1\text{ Hz}$	25°C	2.7		$\mu\text{V}$	
	$f = 0.1\text{ Hz to }10\text{ Hz}$	25°C	4			
$I_n$ Equivalent input noise current		25°C	0.6		fA/ $\sqrt{\text{Hz}}$	
THD + N Total harmonic distortion plus noise	$V_O = 0.5\text{ V to }2.5\text{ V},$ $f = 1\text{ kHz},$ $R_L = 10\text{ k}\Omega\ddagger$	25°C	$A_V = 1$	0.25%		
			$A_V = 10$	1.8%		
Gain-bandwidth product	$f = 10\text{ kHz},$ $C_L = 100\text{ pF}\ddagger$	$R_L = 10\text{ k}\Omega\ddagger,$ 25°C	46		kHz	
BOM Maximum output-swing bandwidth	$V_{O(PP)} = 1\text{ V},$ $R_L = 10\text{ k}\Omega\ddagger,$	$A_V = 1,$ $C_L = 100\text{ pF}\ddagger$ 25°C	8.3		kHz	
$t_s$ Settling time	$A_V = -1,$ Step = 0.5 V to 2.5 V, $R_L = 10\text{ k}\Omega\ddagger,$ $C_L = 100\text{ pF}\ddagger$	25°C	To 0.1%	8.6		$\mu\text{s}$
			To 0.01%	16		
$\phi_m$ Phase margin at unity gain	$R_L = 10\text{ k}\Omega\ddagger,$	25°C	62°			
		Gain margin	25°C	11		dB

† Full range is  $-40^\circ\text{C}$  to  $125^\circ\text{C}$  for Q level part,  $-55^\circ\text{C}$  to  $125^\circ\text{C}$  for M level part.

‡ Referenced to 1.5 V

**TLV2422, TLV2422A**  
**Advanced LinCMOS™ RAIL-TO-RAIL OUTPUT**  
**WIDE-INPUT-VOLTAGE MICROPOWER DUAL OPERATIONAL AMPLIFIERS**

SLOS199C – SEPTEMBER 1997 – REVISED APRIL 2001

**electrical characteristics at specified free-air temperature,  $V_{DD} = 5\text{ V}$  (unless otherwise noted)**

PARAMETER	TEST CONDITIONS	$T_A$ †	TLV2422C			UNIT
			MIN	TYP	MAX	
$V_{IO}$ Input offset voltage	$V_{IC} = 0,$ $V_O = 0,$ $V_{DD} \pm = \pm 2.5\text{ V},$ $R_S = 50\ \Omega$	25°C	300 2000		$\mu\text{V}$	
		Full range	2500			
$\alpha V_{IO}$ Temperature coefficient of input offset voltage		25°C to 70°C	2		$\mu\text{V}/^\circ\text{C}$	
		25°C	0.003		$\mu\text{V}/\text{mo}$	
$I_{IO}$ Input offset current		25°C	0.5	60	$\text{pA}$	
		Full range	150			
$I_{IB}$ Input bias current		25°C	1	60	$\text{pA}$	
		Full range	150			
$V_{ICR}$ Common-mode input voltage range	$ V_{IO}  \leq 5\text{ mV},$ $R_S = 50\ \Omega$	25°C	0 to 4.5	-0.25 to 4.75	$\text{V}$	
		Full range	0 to 4.2			
$V_{OH}$ High-level output voltage	$I_{OH} = -100\ \mu\text{A}$	25°C	4.97		$\text{V}$	
		25°C	4.5	4.75		
		Full range	4.25			
$V_{OL}$ Low-level output voltage	$V_{IC} = 2.5\text{ V},$ $I_{OL} = 100\ \mu\text{A}$	25°C	0.04		$\text{V}$	
		25°C	0.15			
		Full range	0.5			
$A_{VD}$ Large-signal differential voltage amplification	$V_{IC} = 2.5\text{ V},$ $V_O = 1\text{ V to }4\text{ V}$	25°C	$R_L = 10\text{ k}\Omega^\ddagger$	8 12	$\text{V/mV}$	
			Full range	5		
		25°C	$R_L = 1\text{ M}\Omega^\ddagger$	1000		
$r_{i(d)}$ Differential input resistance		25°C	$10^{12}$		$\Omega$	
$r_{i(c)}$ Common-mode input resistance		25°C	$10^{12}$		$\Omega$	
$C_{i(c)}$ Common-mode input capacitance	$f = 10\text{ kHz}$	25°C	8		$\text{pF}$	
$Z_O$ Closed-loop output impedance	$f = 100\text{ kHz},$ $A_V = 10$	25°C	130		$\Omega$	
CMRR Common-mode rejection ratio	$V_{IC} = 0\text{ to }4.5\text{ V},$ $V_O = 2.5\text{ V},$ $R_S = 50\ \Omega$	25°C	70	90	$\text{dB}$	
		Full range	70			
kSVR Supply-voltage rejection ratio ( $\Delta V_{DD}/\Delta V_{IO}$ )	$V_{DD} = 4.4\text{ V to }8\text{ V},$ $V_{IC} = V_{DD}/2,$ No load	25°C	80	95	$\text{dB}$	
		Full range	80			
$I_{DD}$ Supply current	$V_O = 2.5\text{ V},$ No load	25°C	100	150	$\mu\text{A}$	
		Full range	175			

† Full range is 0°C to 70°C.

‡ Referenced to 2.5 V

NOTE 4: Typical values are based on the input offset voltage shift observed through 500 hours of operating life test at  $T_A = 150^\circ\text{C}$  extrapolated to  $T_A = 25^\circ\text{C}$  using the Arrhenius equation and assuming an activation energy of 0.96 eV.



TLV2422, TLV2422A  
Advanced LinCMOS™ RAIL-TO-RAIL OUTPUT  
WIDE-INPUT-VOLTAGE MICROPOWER DUAL OPERATIONAL AMPLIFIERS

SLOS199C – SEPTEMBER 1997 – REVISED APRIL 2001

electrical characteristics at specified free-air temperature,  $V_{DD} = 5\text{ V}$  (unless otherwise noted)

PARAMETER	TEST CONDITIONS	$T_A$ †	TLV2422I			TLV2422AI			UNIT	
			MIN	TYP	MAX	MIN	TYP	MAX		
$V_{IO}$ Input offset voltage		25°C	300	2000		300	950	$\mu\text{V}$		
		Full range		2500		1500				
$\alpha_{VIO}$ Temperature coefficient of input offset voltage		25°C to 70°C	2			2			$\mu\text{V}/^\circ\text{C}$	
Input offset voltage long-term drift (see Note 4)	$V_{IC} = 0,$ $V_O = 0,$	$V_{DD} \pm \pm 2.5\text{ V},$ $R_S = 50\ \Omega$	25°C	0.003			0.003			$\mu\text{V}/\text{mo}$
$I_{IO}$ Input offset current		25°C	0.5	60		0.5	60	$\text{pA}$		
		Full range		150		150				
$I_{IB}$ Input bias current		25°C	1	60		1	60	$\text{pA}$		
		Full range		150		150				
$V_{ICR}$ Common-mode input voltage range	$ V_{IO}  \leq 5\text{ mV},$ $R_S = 50\ \Omega$	25°C	0 to 4.5	-0.25 to 4.75		0 to 4.5	-0.25 to 4.75	V		
		Full range	0 to 4.2			0 to 4.2				
$V_{OH}$ High-level output voltage	$I_{OH} = -100\ \mu\text{A}$ $I_{OH} = -1\text{ mA}$	25°C	4.97			4.97			V	
		25°C	4.5	4.75		4.5	4.75			
		Full range	4.25			4.25				
$V_{OL}$ Low-level output voltage	$V_{IC} = 2.5\text{ V},$ $I_{OL} = 100\ \mu\text{A}$ $V_{IC} = 2.5\text{ V},$ $I_{OL} = 500\ \mu\text{A}$	25°C	0.04			0.04			V	
		25°C	0.15			0.15				
		Full range	0.5			0.5				
$A_{VD}$ Large-signal differential voltage amplification	$V_{IC} = 2.5\text{ V},$ $V_O = 1\text{ V to }4\text{ V}$	25°C	$R_L = 10\text{ k}\Omega^\ddagger$			8 12			V/mV	
			$R_L = 1\text{ M}\Omega^\ddagger$			1000				
		Full range	5			5				
$r_{i(d)}$ Differential input resistance		25°C	$10^{12}$			$10^{12}$			$\Omega$	
$r_{i(c)}$ Common-mode input resistance		25°C	$10^{12}$			$10^{12}$			$\Omega$	
$c_{i(c)}$ Common-mode input capacitance	$f = 10\text{ kHz}$	25°C	8			8			pF	
$z_o$ Closed-loop output impedance	$f = 100\text{ kHz},$ $A_V = 10$	25°C	130			130			$\Omega$	
CMRR Common-mode rejection ratio	$V_{IC} = 0\text{ to }4.5\text{ V},$ $V_O = 2.5\text{ V},$ $R_S = 50\ \Omega$	25°C	70	90		70	90	dB		
		Full range	70			70				
$k_{SVR}$ Supply-voltage rejection ratio ( $\Delta V_{DD}/\Delta V_{IO}$ )	$V_{DD} = 4.4\text{ V to }8\text{ V},$ $V_{IC} = V_{DD}/2,$ No load	25°C	80	95		80	95	dB		
		Full range	80			80				
$I_{DD}$ Supply current	$V_O = 2.5\text{ V},$ No load	25°C	100	150		100	150	$\mu\text{A}$		
		Full range	175			175				

† Full range is  $-40^\circ\text{C}$  to  $85^\circ\text{C}$ .

‡ Referenced to 2.5 V

NOTE 4: Typical values are based on the input offset voltage shift observed through 500 hours of operating life test at  $T_A = 150^\circ\text{C}$  extrapolated to  $T_A = 25^\circ\text{C}$  using the Arrhenius equation and assuming an activation energy of 0.96 eV.

**TLV2422, TLV2422A**  
**Advanced LinCMOS™ RAIL-TO-RAIL OUTPUT**  
**WIDE-INPUT-VOLTAGE MICROPOWER DUAL OPERATIONAL AMPLIFIERS**

SLOS199C – SEPTEMBER 1997 – REVISED APRIL 2001

operating characteristics at specified free-air temperature,  $V_{DD} = 5\text{ V}$

PARAMETER	TEST CONDITIONS	$T_A$ †	TLV2422C, TLV2422I TLV2422AI			UNIT
			MIN	TYP	MAX	
SR Slew rate at unity gain	$V_O = 1.5\text{ V to }3.5\text{ V},$ $C_L = 100\text{ pF}‡$	25°C	0.01	0.02		V/ $\mu\text{s}$
		Full range	0.008			
$V_n$ Equivalent input noise voltage	$f = 10\text{ Hz}$	25°C	100		nV/ $\sqrt{\text{Hz}}$	
	$f = 1\text{ kHz}$	25°C	18			
$V_{N(PP)}$ Peak-to-peak equivalent input noise voltage	$f = 0.1\text{ Hz to }1\text{ Hz}$	25°C	1.9		$\mu\text{V}$	
	$f = 0.1\text{ Hz to }10\text{ Hz}$	25°C	2.8			
$I_n$ Equivalent input noise current		25°C	0.6		fA/ $\sqrt{\text{Hz}}$	
THD + N Total harmonic distortion plus noise	$V_O = 1.5\text{ V to }3.5\text{ V},$ $f = 1\text{ kHz},$ $R_L = 10\text{ k}\Omega‡$	$A_V = 1$	0.24%			
		$A_V = 10$	1.7%			
Gain-bandwidth product	$f = 10\text{ kHz},$ $C_L = 100\text{ pF}‡$	$R_L = 10\text{ k}\Omega‡,$ 25°C	52		kHz	
$B_{OM}$ Maximum output-swing bandwidth	$V_{O(PP)} = 2\text{ V},$ $R_L = 10\text{ k}\Omega‡,$	$A_V = 1,$ $C_L = 100\text{ pF}‡$ 25°C	5.3		kHz	
$t_s$ Settling time	$A_V = -1,$ Step = 1.5 V to 3.5 V, $R_L = 10\text{ k}\Omega‡,$ $C_L = 100\text{ pF}‡$	To 0.1%	8.5		$\mu\text{s}$	
		To 0.01%	15.5			
$\phi_m$ Phase margin at unity gain	$R_L = 10\text{ k}\Omega‡,$ $C_L = 100\text{ pF}‡$	25°C	66°			
Gain margin		25°C	11		dB	

† Full range for the C version is 0°C to 70°C. Full range for the I version is -40°C to 85°C.

‡ Referenced to 2.5 V



**TLV2422, TLV2422A**  
**Advanced LinCMOS™ RAIL-TO-RAIL OUTPUT**  
**WIDE-INPUT-VOLTAGE MICROPOWER DUAL OPERATIONAL AMPLIFIERS**

SLOS199C – SEPTEMBER 1997 – REVISED APRIL 2001

**electrical characteristics at specified free-air temperature,  $V_{DD} = 5\text{ V}$  (unless otherwise noted)**

PARAMETER	TEST CONDITIONS	$T_A$ †	TLV2422Q, TLV2422M			TLV2422AQ, TLV2422AM			UNIT	
			MIN	TYP	MAX	MIN	TYP	MAX		
$V_{IO}$ Input offset voltage		25°C	300	2000		300	950	$\mu\text{V}$		
		Full range		2500		1800				
$\alpha_{V_{IO}}$ Temperature coefficient of input offset voltage		Full range	2			2			$\mu\text{V}/^\circ\text{C}$	
Input offset voltage long-term drift (see Note 4)	$V_{IC} = 0,$ $V_O = 0,$	$V_{DD} \pm \pm 2.5\text{ V},$ $R_S = 50\ \Omega$	25°C	0.003			0.003			$\mu\text{V}/\text{mo}$
$I_{IO}$ Input offset current		25°C	0.5	60		0.5	60	$\text{pA}$		
		Full range		150		150				
$I_{IB}$ Input bias current		25°C	1	60		1	60	$\text{pA}$		
		Full range		300		300				
$V_{ICR}$ Common-mode input voltage range	$ V_{IO}  \leq 5\text{ mV},$ $R_S = 50\ \Omega$	25°C	0 to 4.5	-0.25 to 4.75		0 to 4.5	-0.25 to 4.75	V		
		Full range	0 to 4.2			0 to 4.2				
$V_{OH}$ High-level output voltage	$I_{OH} = -100\ \mu\text{A}$ $I_{OH} = -1\text{ mA}$	25°C	4.97			4.97			V	
		25°C	4.75			4.75				
		Full range	4.5			4.5				
$V_{OL}$ Low-level output voltage	$V_{IC} = 2.5\text{ V},$ $I_{OL} = 100\ \mu\text{A}$ $V_{IC} = 2.5\text{ V},$ $I_{OL} = 500\ \mu\text{A}$	25°C	0.04			0.04			V	
		25°C	0.15			0.15				
		Full range		0.5		0.5				
$A_{VD}$ Large-signal differential voltage amplification	$V_{IC} = 2.5\text{ V},$ $V_O = 1\text{ V to }4\text{ V}$	$R_L = 10\text{ k}\Omega^\ddagger$	25°C	8	12		8	12	V/mV	
			Full range	3			3			
		$R_L = 1\text{ M}\Omega^\ddagger$	25°C	1000			1000			
$r_{i(d)}$ Differential input resistance		25°C	$10^{12}$			$10^{12}$			$\Omega$	
$r_{i(c)}$ Common-mode input resistance		25°C	$10^{12}$			$10^{12}$			$\Omega$	
$c_{i(c)}$ Common-mode input capacitance	$f = 10\text{ kHz}$	25°C	8			8			$\text{pF}$	
$z_o$ Closed-loop output impedance	$f = 100\text{ kHz},$ $A_V = 10$	25°C	130			130			$\Omega$	
CMRR Common-mode rejection ratio	$V_{IC} = V_{ICR}\text{ min},$ $V_O = 2.5\text{ V},$ $R_S = 50\ \Omega$	25°C	70	90		70	90	dB		
		Full range	70			70				
$k_{SVR}$ Supply-voltage rejection ratio ( $\Delta V_{DD}/\Delta V_{IO}$ )	$V_{DD} = 4.4\text{ V to }8\text{ V},$ $V_{IC} = V_{DD}/2,$ No load	25°C	80	95		80	95	dB		
		Full range	80			80				
$I_{DD}$ Supply current	$V_O = 2.5\text{ V},$ No load	25°C	100	150		100	150	$\mu\text{A}$		
		Full range		175		175				

† Full range is  $-40^\circ\text{C}$  to  $125^\circ\text{C}$  for Q level part,  $-55^\circ\text{C}$  to  $125^\circ\text{C}$  for M level part.

‡ Referenced to 2.5 V

NOTE 4: Typical values are based on the input offset voltage shift observed through 500 hours of operating life test at  $T_A = 150^\circ\text{C}$  extrapolated to  $T_A = 25^\circ\text{C}$  using the Arrhenius equation and assuming an activation energy of 0.96 eV.



**TLV2422, TLV2422A**  
**Advanced LinCMOS™ RAIL-TO-RAIL OUTPUT**  
**WIDE-INPUT-VOLTAGE MICROPOWER DUAL OPERATIONAL AMPLIFIERS**

SLOS199C – SEPTEMBER 1997 – REVISED APRIL 2001

operating characteristics at specified free-air temperature,  $V_{DD} = 5\text{ V}$

PARAMETER	TEST CONDITIONS	$T_A$ †	TLV2422Q, TLV2422M, TLV2422AQ, TLV2422AM			UNIT
			MIN	TYP	MAX	
SR Slew rate at unity gain	$V_O = 1.5\text{ V to }3.5\text{ V},$ $R_L = 10\text{ k}\Omega$ ‡, $C_L = 100\text{ pF}$ ‡	25°C	0.01	0.02		V/ $\mu\text{s}$
		Full range	0.008			
$V_n$ Equivalent input noise voltage	$f = 10\text{ Hz}$	25°C	100		nV/ $\sqrt{\text{Hz}}$	
	$f = 1\text{ kHz}$	25°C	18			
$V_{N(PP)}$ Peak-to-peak equivalent input noise voltage	$f = 0.1\text{ Hz to }1\text{ Hz}$	25°C	1.9		$\mu\text{V}$	
	$f = 0.1\text{ Hz to }10\text{ Hz}$	25°C	2.8			
$I_n$ Equivalent input noise current		25°C	0.6		fA/ $\sqrt{\text{Hz}}$	
THD + N Total harmonic distortion plus noise	$V_O = 1.5\text{ V to }3.5\text{ V},$ $f = 1\text{ kHz},$ $R_L = 10\text{ k}\Omega$ ‡	$A_V = 1$	0.24%			
		$A_V = 10$	1.7%			
Gain-bandwidth product	$f = 10\text{ kHz},$ $C_L = 100\text{ pF}$ ‡	$R_L = 10\text{ k}\Omega$ ‡, 25°C	52		kHz	
BOM Maximum output-swing bandwidth	$V_{O(PP)} = 2\text{ V},$ $R_L = 10\text{ k}\Omega$ ‡,	$A_V = 1,$ $C_L = 100\text{ pF}$ ‡	25°C	5.3		kHz
$t_s$ Settling time	$A_V = -1,$ Step = 1.5 V to 3.5 V, $R_L = 10\text{ k}\Omega$ ‡, $C_L = 100\text{ pF}$ ‡	To 0.1%	25°C	8.5		$\mu\text{s}$
		To 0.01%		15.5		
$\phi_m$ Phase margin at unity gain	$R_L = 10\text{ k}\Omega$ ‡,	$C_L = 100\text{ pF}$ ‡	25°C	66°		
Gain margin			25°C	11		dB

† Full range is  $-40^\circ\text{C}$  to  $125^\circ\text{C}$  for Q level part,  $-55^\circ\text{C}$  to  $125^\circ\text{C}$  for M level part.

‡ Referenced to 2.5 V



## TYPICAL CHARACTERISTICS

### Table of Graphs

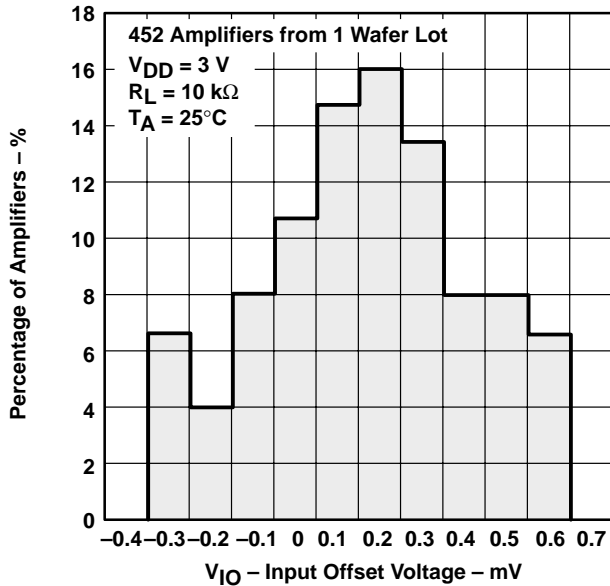
			FIGURE
$V_{IO}$	Input offset voltage	Distribution vs Common-mode input voltage	2,3 4,5
$\alpha_{VIO}$	Input offset voltage temperature coefficient	Distribution	6,7
$I_{IB}/I_{IO}$	Input bias and input offset currents	vs Free-air temperature	8
$V_{OH}$	High-level output voltage	vs High-level output current	9,11
$V_{OL}$	Low-level output voltage	vs Low-level output current	10,12
$V_{O(PP)}$	Maximum peak-to-peak output voltage	vs Frequency	13
$I_{OS}$	Short-circuit output current	vs Supply voltage	14
		vs Free-air temperature	15
$V_{ID}$	Differential input voltage	vs Output voltage	16,17
		Differential gain	18
$A_{VD}$	Large-signal differential voltage amplification Differential voltage amplification	vs Frequency	19,20
		vs Free-air temperature	21,22
$z_o$	Output impedance	vs Frequency	23,24
CMRR	Common-mode rejection ratio	vs Frequency	25
		vs Free-air temperature	26
$k_{SVR}$	Supply-voltage rejection ratio	vs Frequency	27,28
		vs Free-air temperature	29
$I_{DD}$	Supply current	vs Supply voltage	30
SR	Slew rate	vs Load capacitance	31
		vs Free-air temperature	32
$V_O$	Inverting large-signal pulse response		33,34
$V_O$	Voltage-follower large-signal pulse response		35,36
$V_O$	Inverting small-signal pulse response		37,38
$V_O$	Voltage-follower small-signal pulse response		39,40
$V_n$	Equivalent input noise voltage	vs Frequency	41, 42
		Noise voltage (referred to input)	Over a 10-second period 43
THD + N	Total harmonic distortion plus noise	vs Frequency	44,45
		Gain-bandwidth product	vs Supply voltage vs Free-air temperature 46 47
$\phi_m$	Phase margin	vs Frequency	19,20
		vs Load capacitance	48
	Gain margin	vs Load capacitance	49
$B_1$	Unity-gain bandwidth	vs Load capacitance	50

**TLV2422, TLV2422A**  
**Advanced LinCMOS™ RAIL-TO-RAIL OUTPUT**  
**WIDE-INPUT-VOLTAGE MICROPOWER DUAL OPERATIONAL AMPLIFIERS**

SLOS199C – SEPTEMBER 1997 – REVISED APRIL 2001

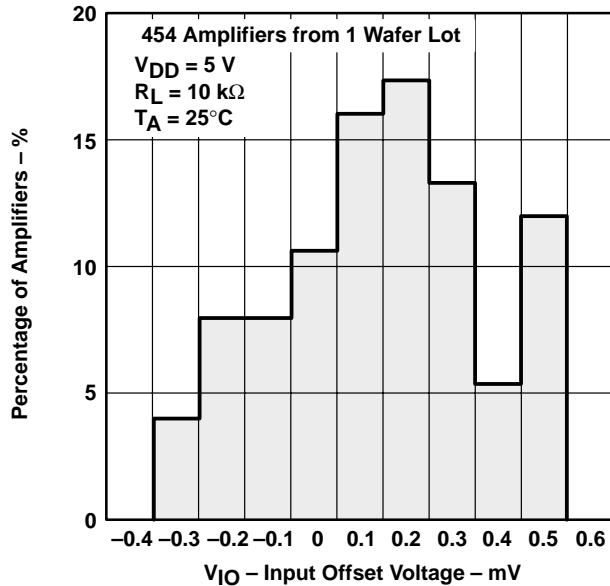
**TYPICAL CHARACTERISTICS**

**DISTRIBUTION OF TLV2422  
 INPUT OFFSET VOLTAGE**



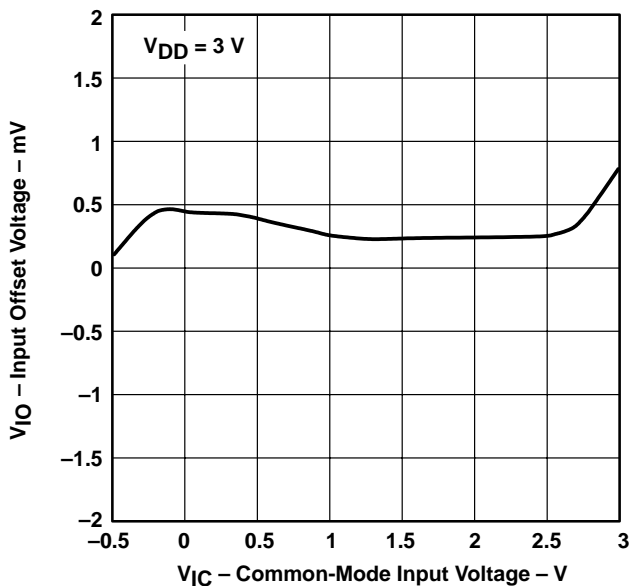
**Figure 2**

**DISTRIBUTION OF TLV2422  
 INPUT OFFSET VOLTAGE**



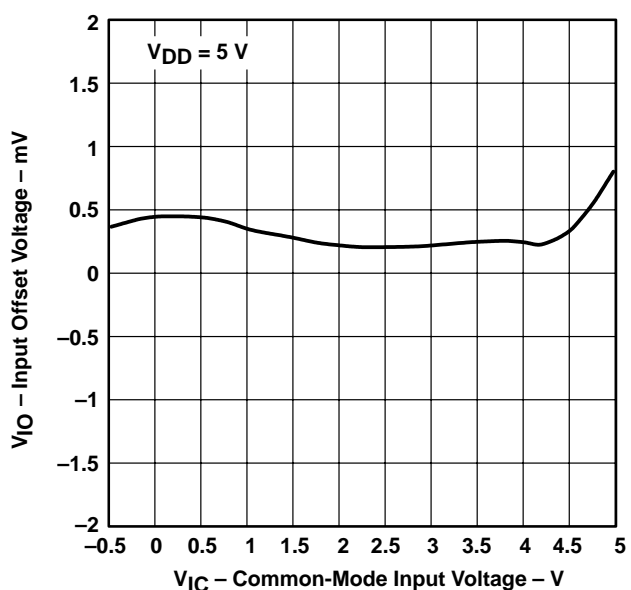
**Figure 3**

**INPUT OFFSET VOLTAGE  
 vs  
 COMMON-MODE INPUT VOLTAGE**



**Figure 4**

**INPUT OFFSET VOLTAGE  
 vs  
 COMMON-MODE INPUT VOLTAGE**



**Figure 5**





**TYPICAL CHARACTERISTICS**

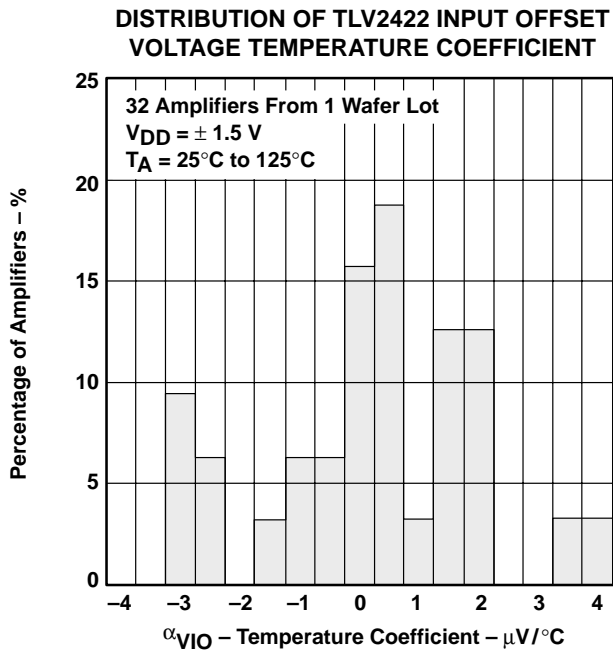


Figure 6

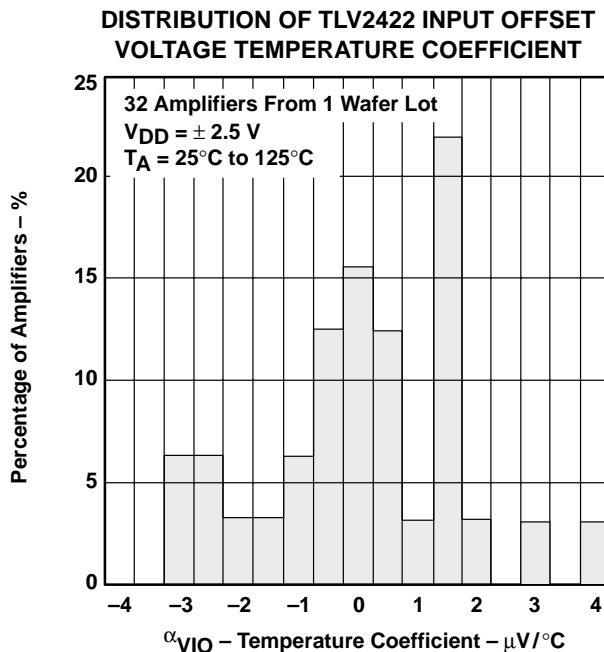


Figure 7

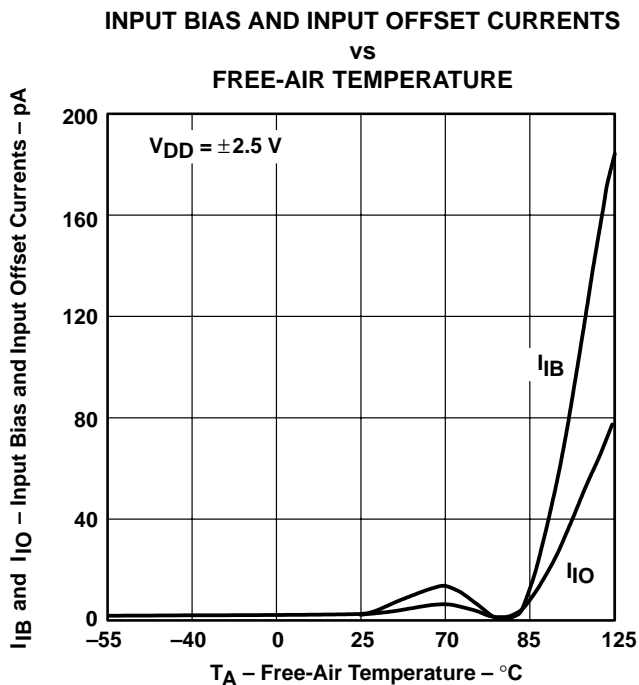


Figure 8

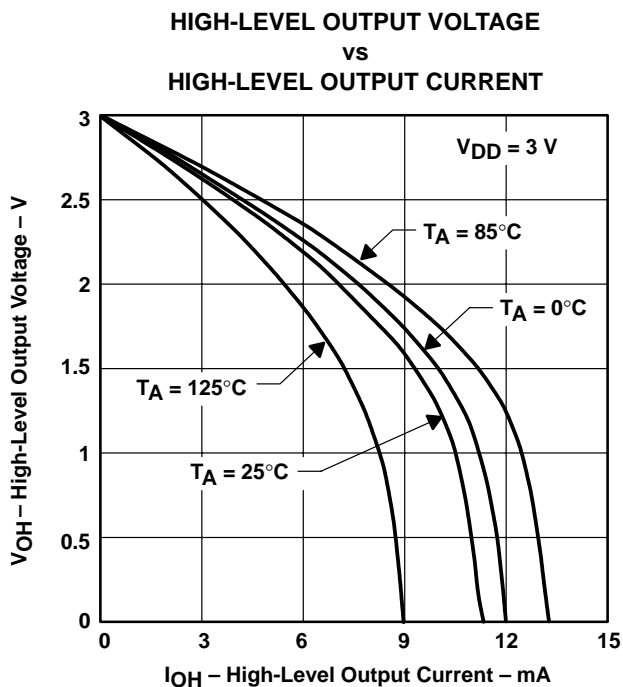
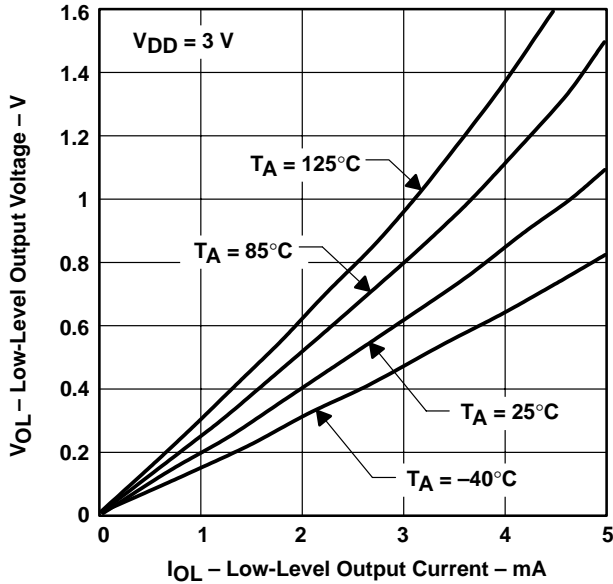


Figure 9

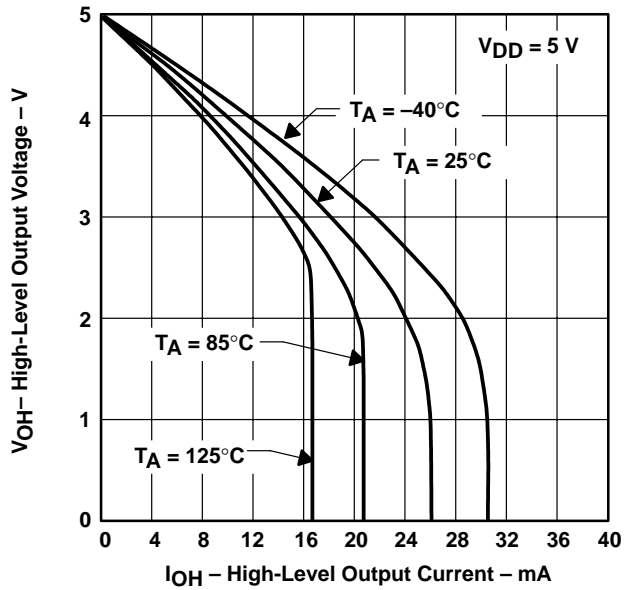
**TYPICAL CHARACTERISTICS**

**LOW-LEVEL OUTPUT VOLTAGE  
 vs  
 LOW-LEVEL OUTPUT CURRENT**



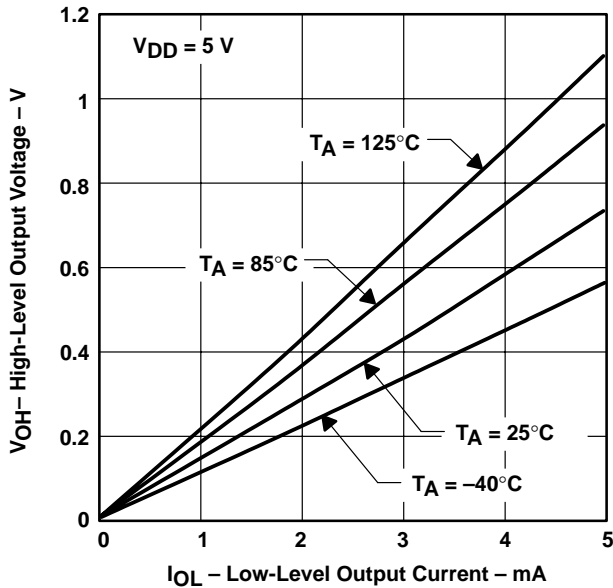
**Figure 10**

**HIGH-LEVEL OUTPUT VOLTAGE  
 vs  
 HIGH-LEVEL OUTPUT CURRENT**



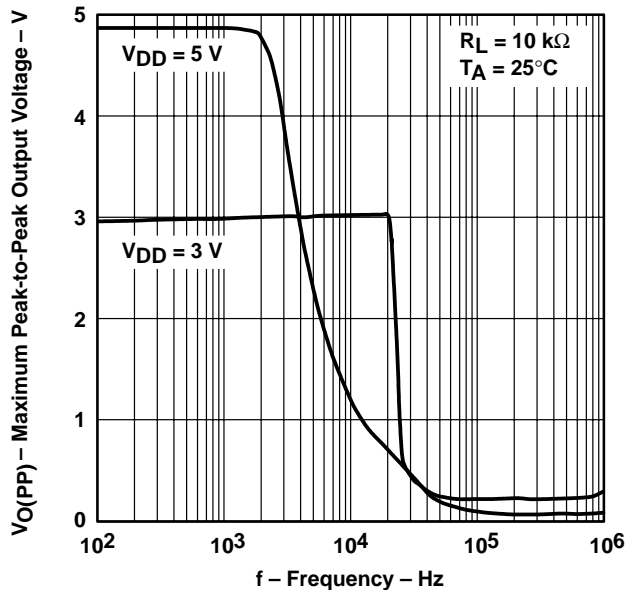
**Figure 11**

**LOW-LEVEL OUTPUT VOLTAGE  
 vs  
 LOW-LEVEL OUTPUT CURRENT**



**Figure 12**

**MAXIMUM PEAK-TO-PEAK OUTPUT VOLTAGE  
 vs  
 FREQUENCY**



**Figure 13**

TYPICAL CHARACTERISTICS

SHORT-CIRCUIT OUTPUT CURRENT  
vs  
SUPPLY VOLTAGE

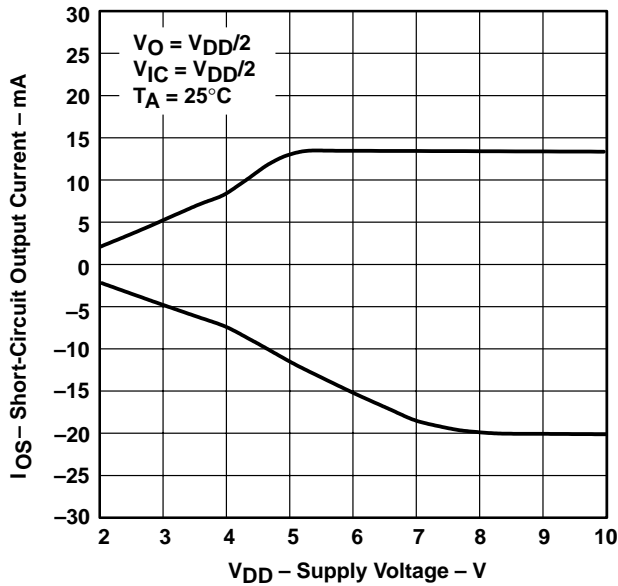


Figure 14

SHORT-CIRCUIT OUTPUT CURRENT  
vs  
FREE-AIR TEMPERATURE

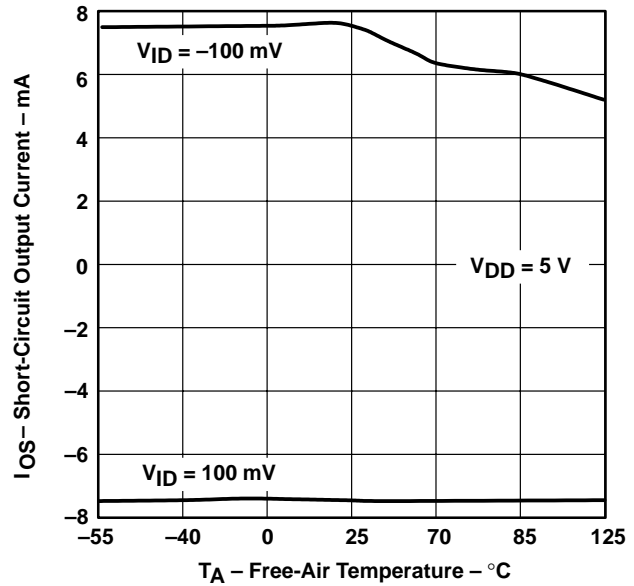


Figure 15

DIFFERENTIAL INPUT VOLTAGE  
vs  
OUTPUT VOLTAGE

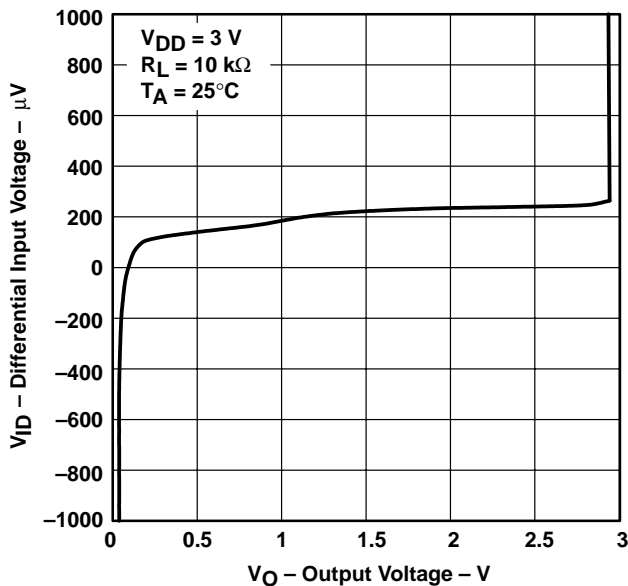


Figure 16

DIFFERENTIAL INPUT VOLTAGE  
vs  
OUTPUT VOLTAGE

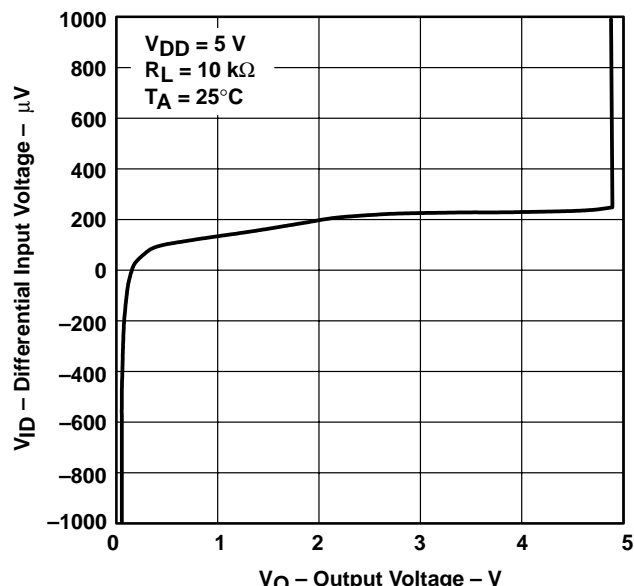


Figure 17

TYPICAL CHARACTERISTICS

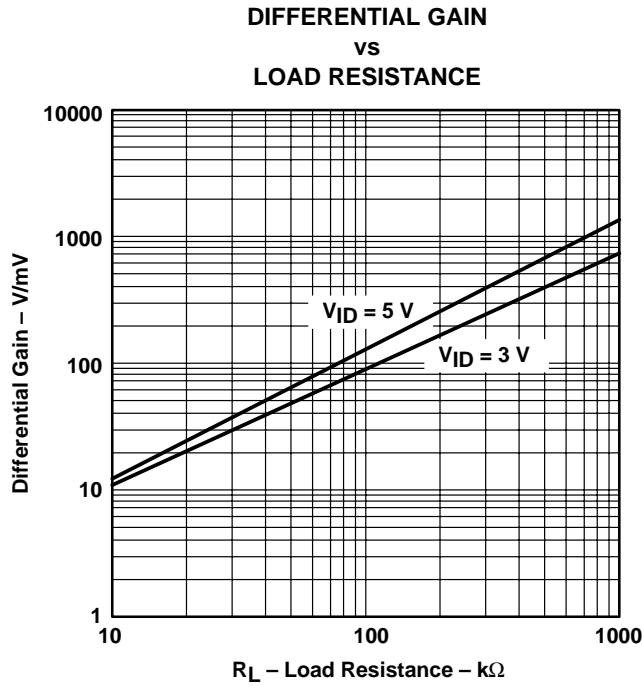


Figure 18

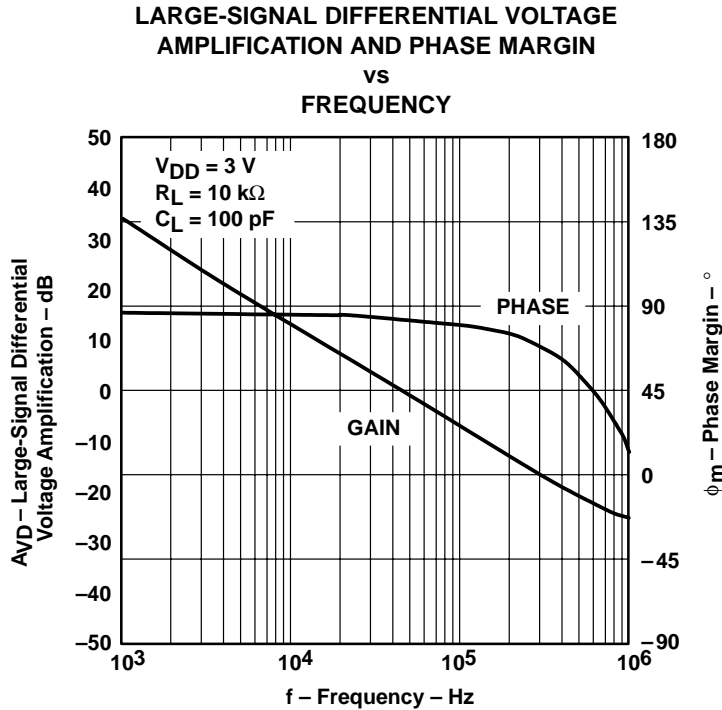
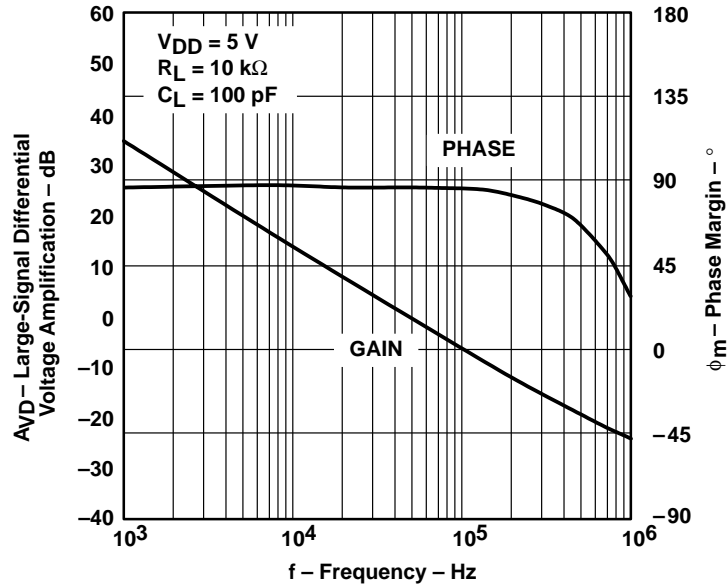


Figure 19

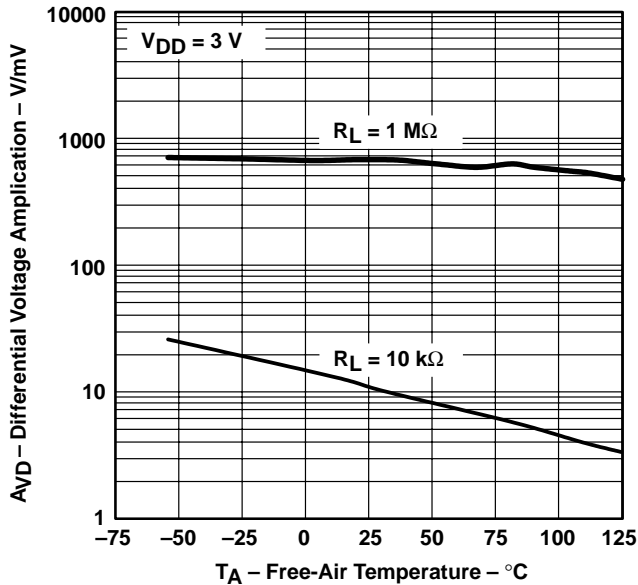
**TYPICAL CHARACTERISTICS**

**LARGE-SIGNAL DIFFERENTIAL VOLTAGE  
AMPLIFICATION AND PHASE MARGIN**

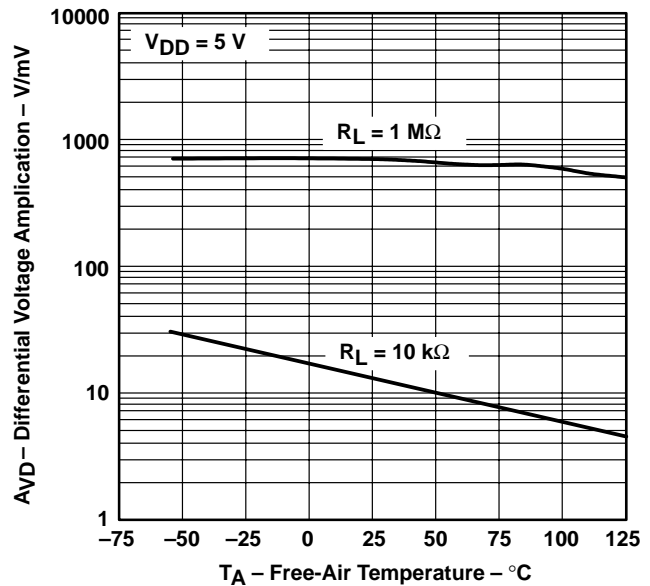
vs  
**FREQUENCY**



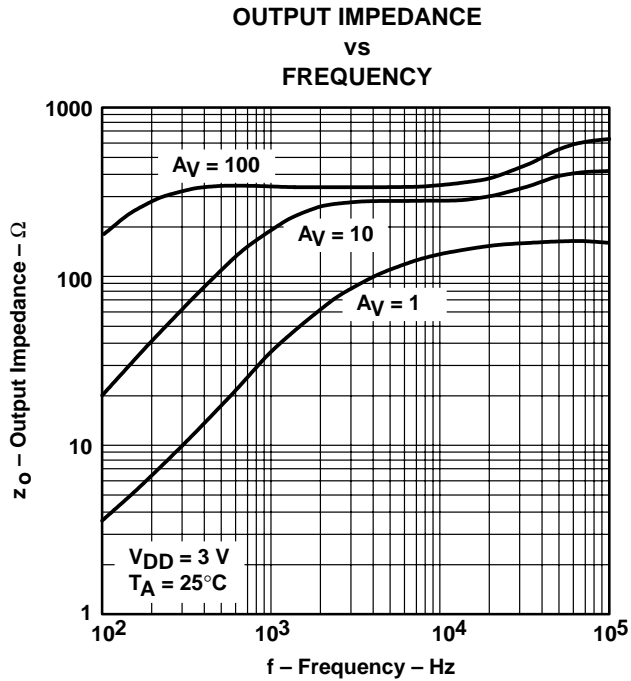
**DIFFERENTIAL VOLTAGE AMPLIFICATION  
vs  
FREE-AIR TEMPERATURE**



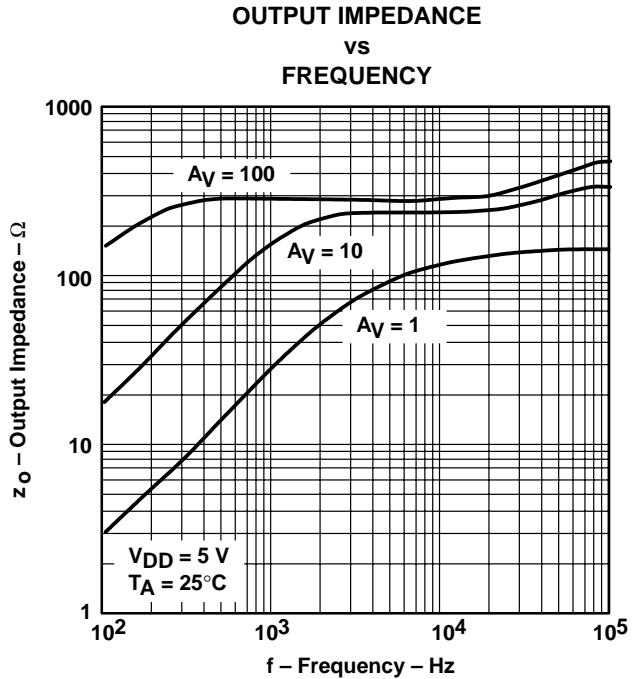
**DIFFERENTIAL VOLTAGE AMPLIFICATION  
vs  
FREE-AIR TEMPERATURE**



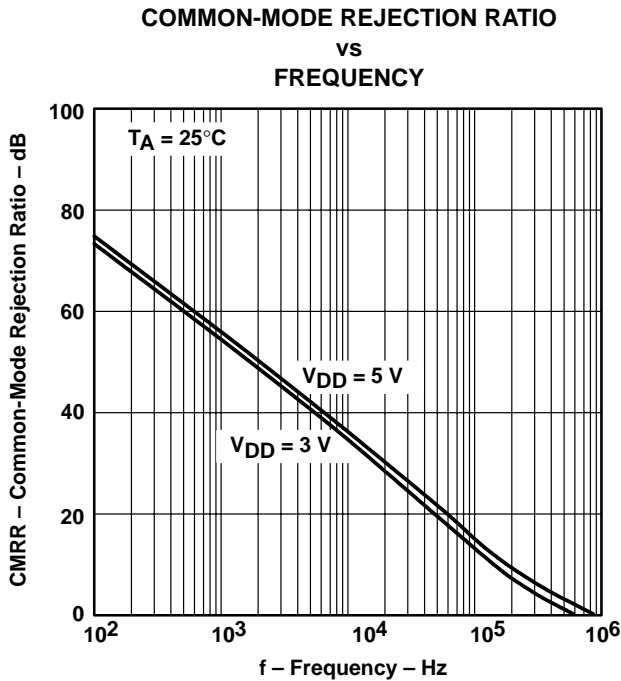
**TYPICAL CHARACTERISTICS**



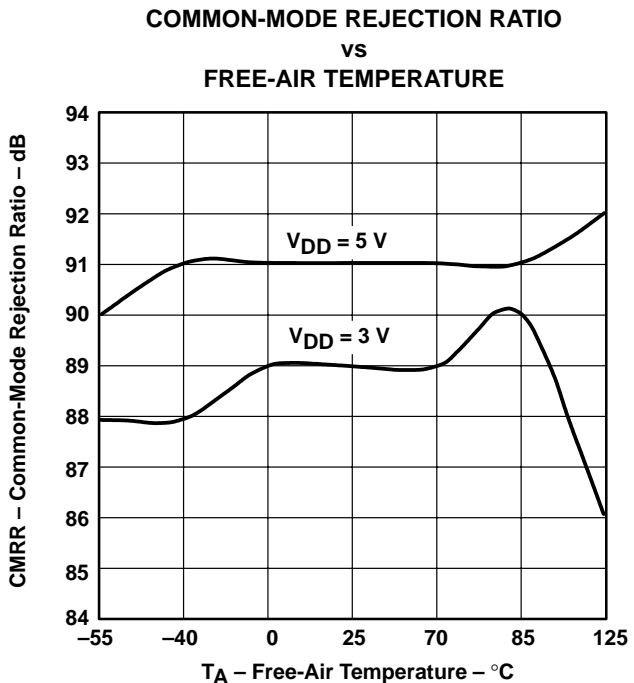
**Figure 23**



**Figure 24**

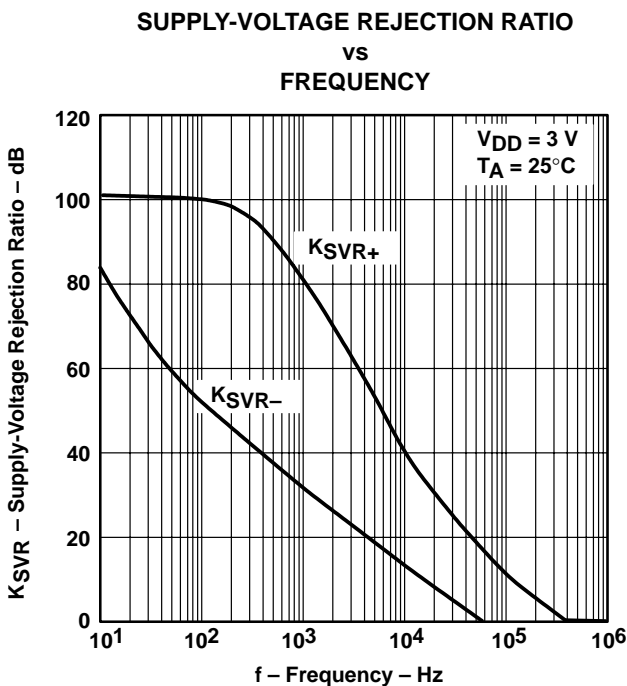


**Figure 25**

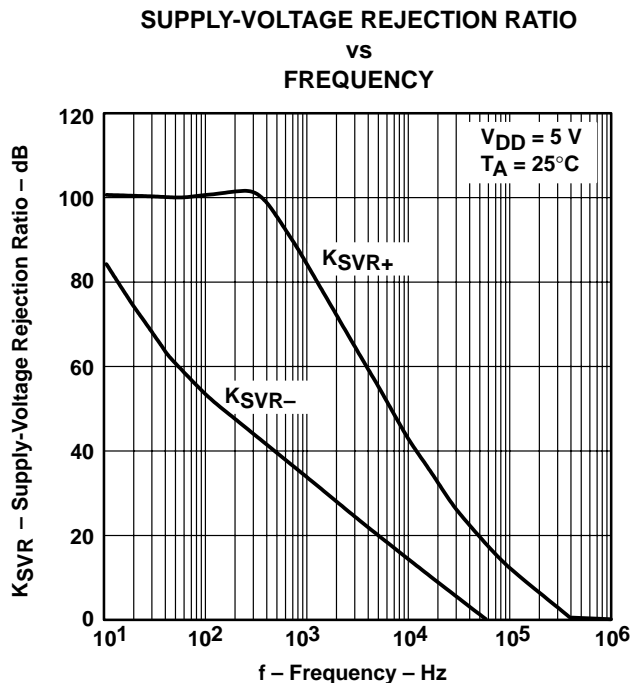


**Figure 26**

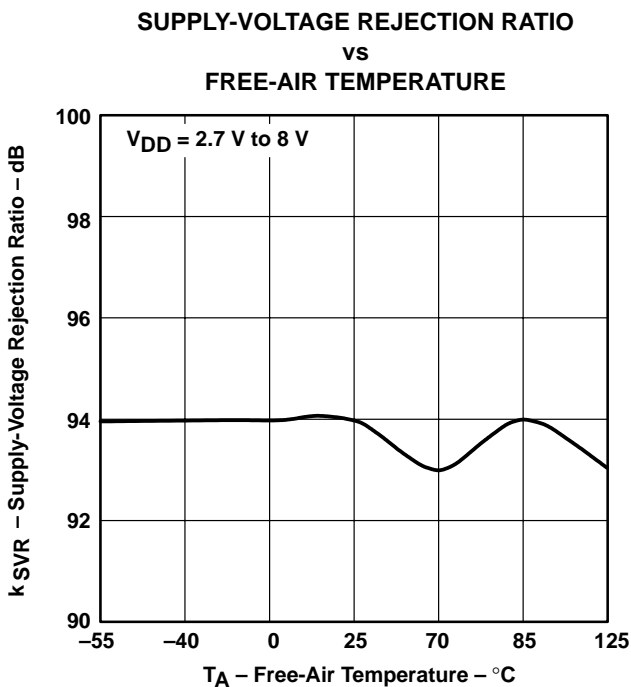
**TYPICAL CHARACTERISTICS**



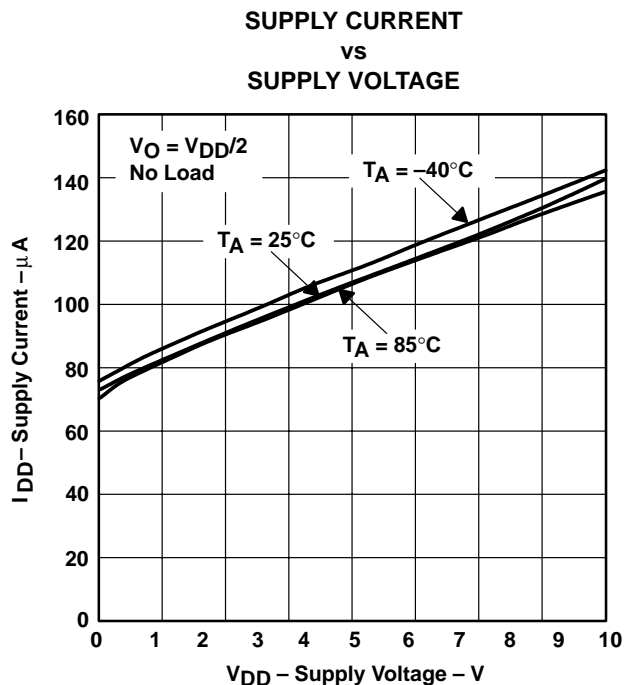
**Figure 27**



**Figure 28**

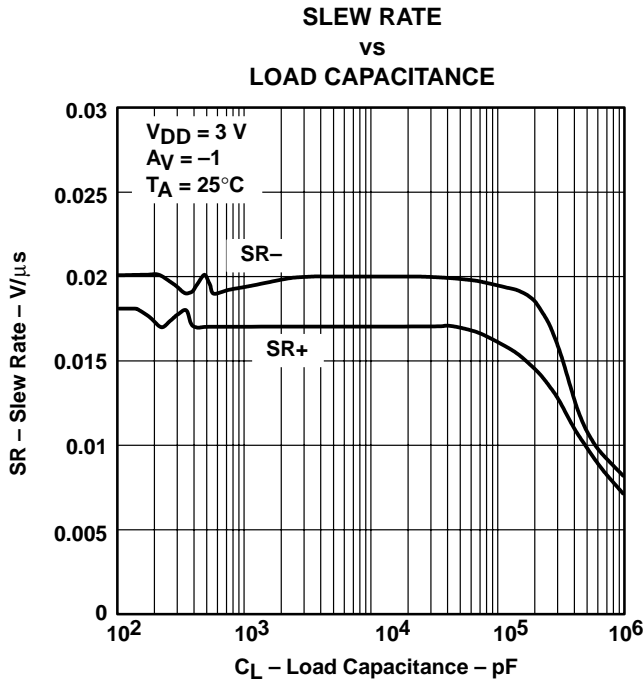


**Figure 29**

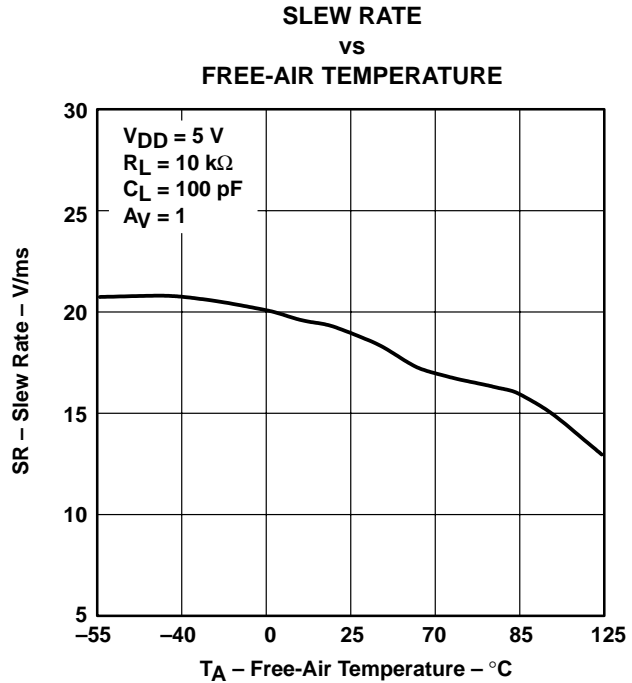


**Figure 30**

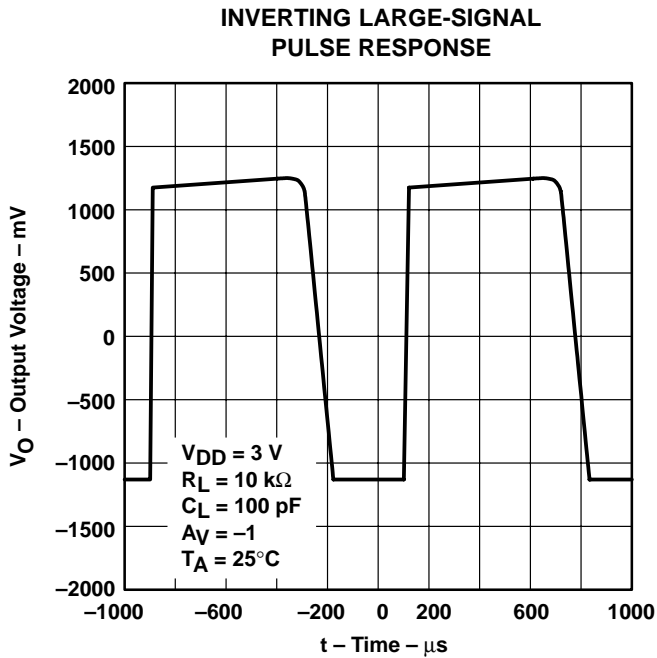
**TYPICAL CHARACTERISTICS**



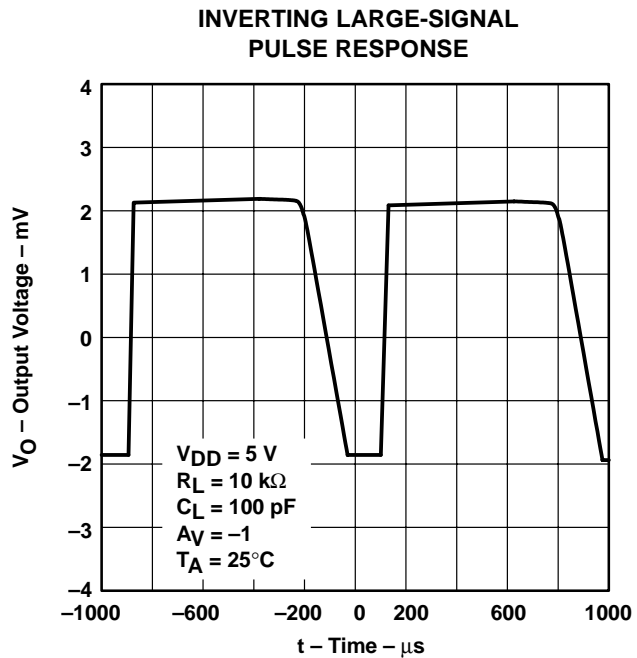
**Figure 31**



**Figure 32**



**Figure 33**

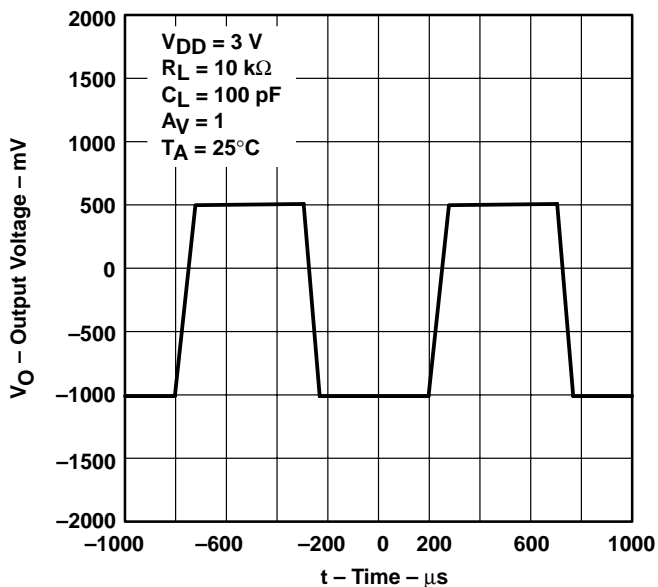


**Figure 34**



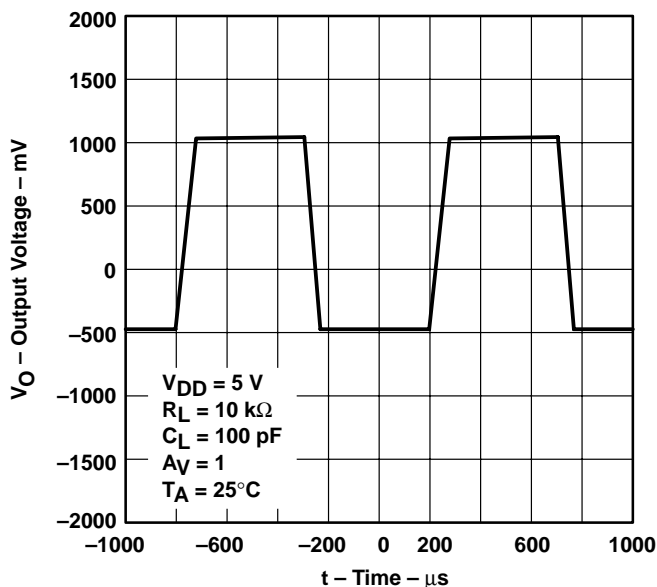
**TYPICAL CHARACTERISTICS**

**VOLTAGE-FOLLOWER LARGE-SIGNAL PULSE RESPONSE**



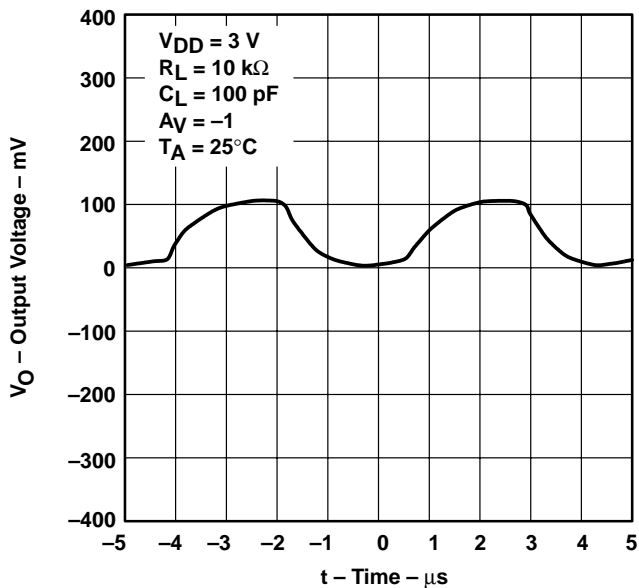
**Figure 35**

**VOLTAGE-FOLLOWER LARGE-SIGNAL PULSE RESPONSE**



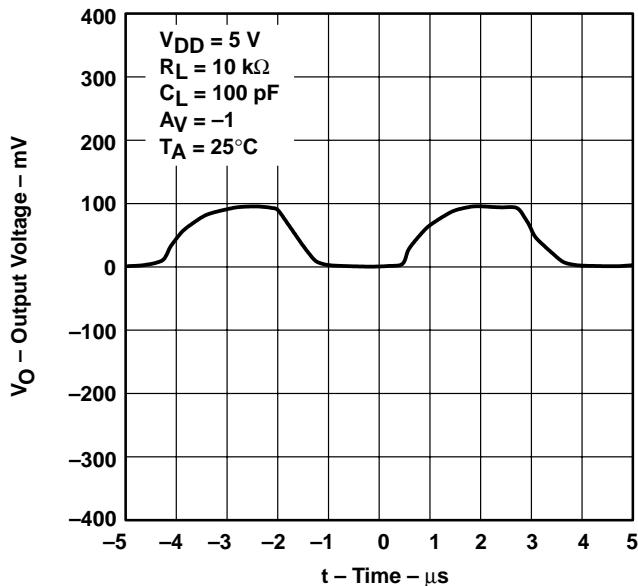
**Figure 36**

**INVERTING SMALL-SIGNAL PULSE RESPONSE**



**Figure 37**

**INVERTING SMALL-SIGNAL PULSE RESPONSE**



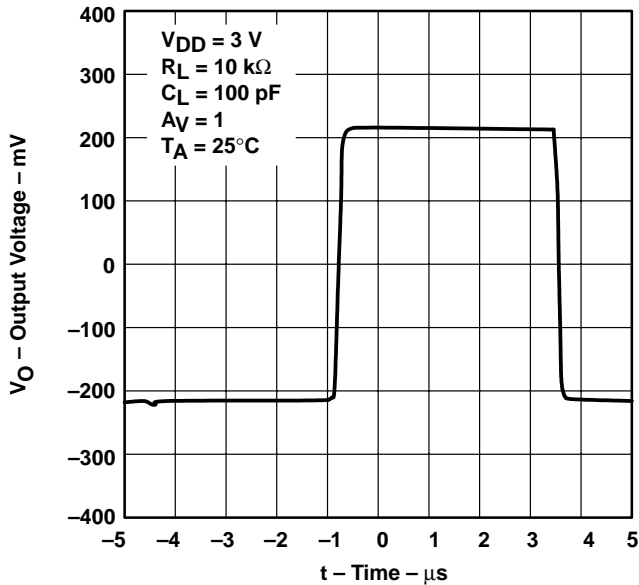
**Figure 38**

**TLV2422, TLV2422A**  
**Advanced LinCMOS™ RAIL-TO-RAIL OUTPUT**  
**WIDE-INPUT-VOLTAGE MICROPOWER DUAL OPERATIONAL AMPLIFIERS**

SLOS199C – SEPTEMBER 1997 – REVISED APRIL 2001

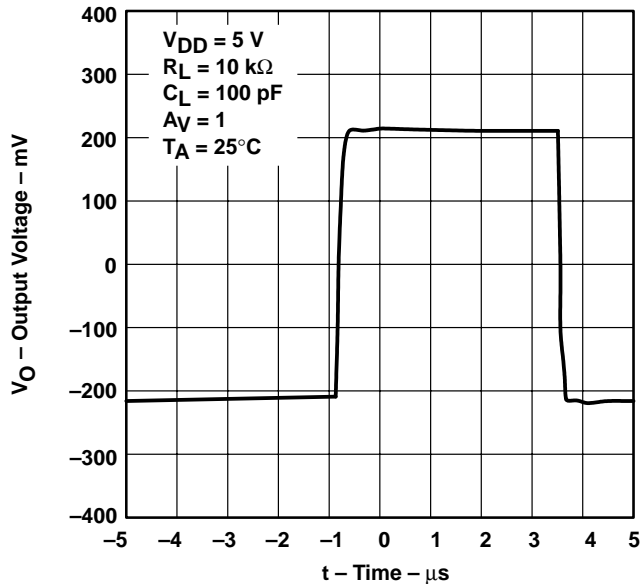
**TYPICAL CHARACTERISTICS**

**VOLTAGE-FOLLOWER SMALL-SIGNAL PULSE RESPONSE**



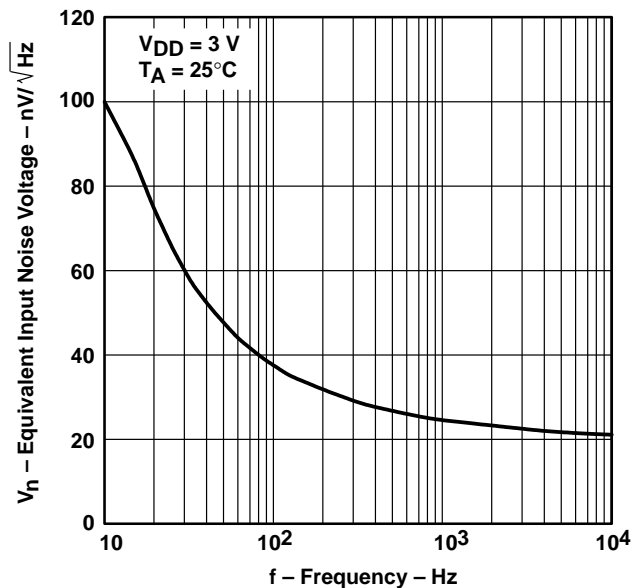
**Figure 39**

**VOLTAGE-FOLLOWER SMALL-SIGNAL PULSE RESPONSE**



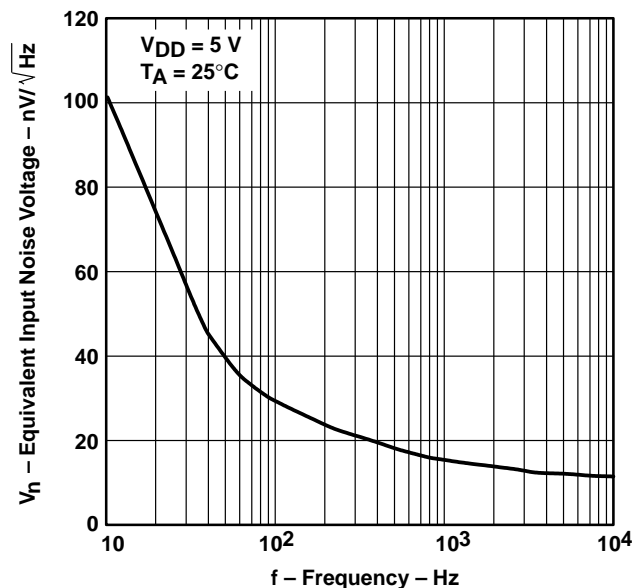
**Figure 40**

**EQUIVALENT INPUT NOISE VOLTAGE VS FREQUENCY**



**Figure 41**

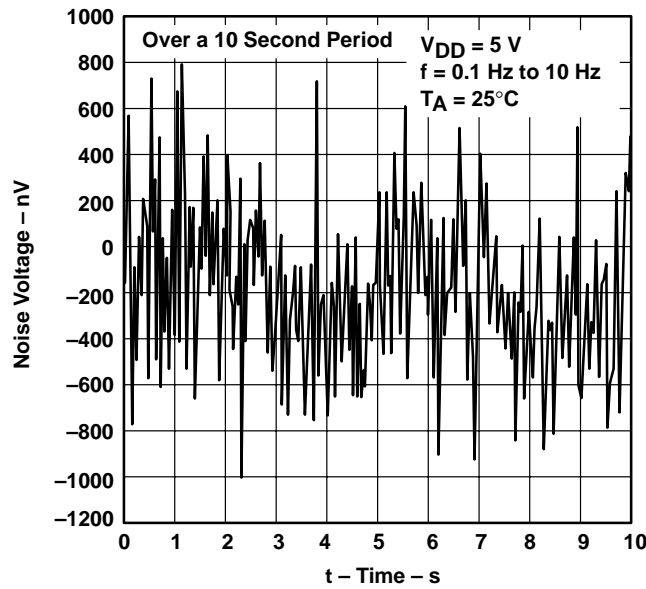
**EQUIVALENT INPUT NOISE VOLTAGE VS FREQUENCY**



**Figure 42**

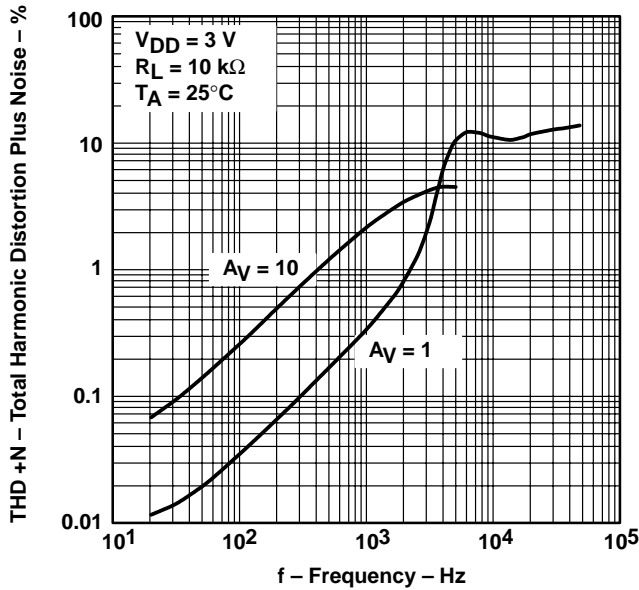
**TYPICAL CHARACTERISTICS**

**NOISE VOLTAGE OVER A 10-SECOND PERIOD**



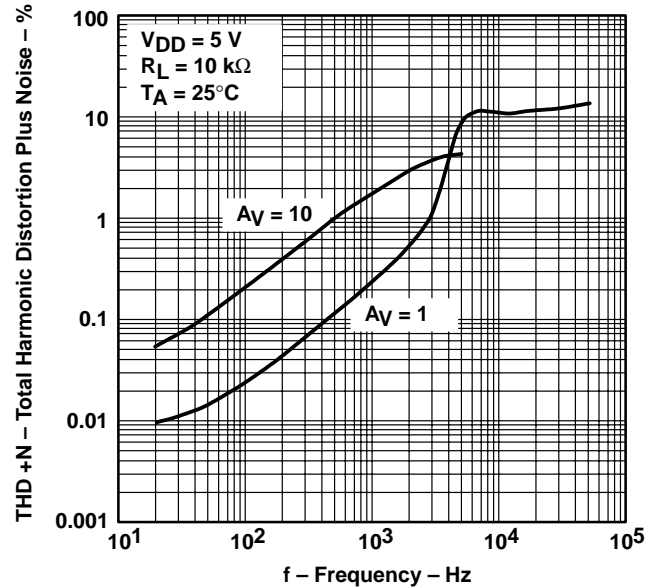
**Figure 43**

**TOTAL HARMONIC DISTORTION PLUS NOISE  
vs  
FREQUENCY**



**Figure 44**

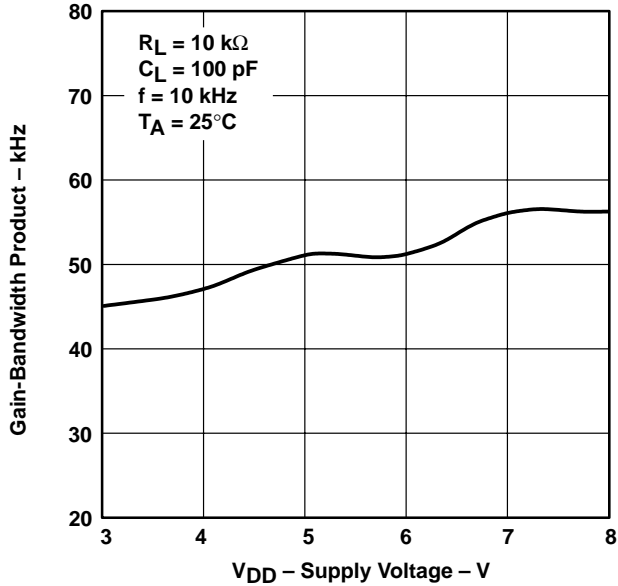
**TOTAL HARMONIC DISTORTION PLUS NOISE  
vs  
FREQUENCY**



**Figure 45**

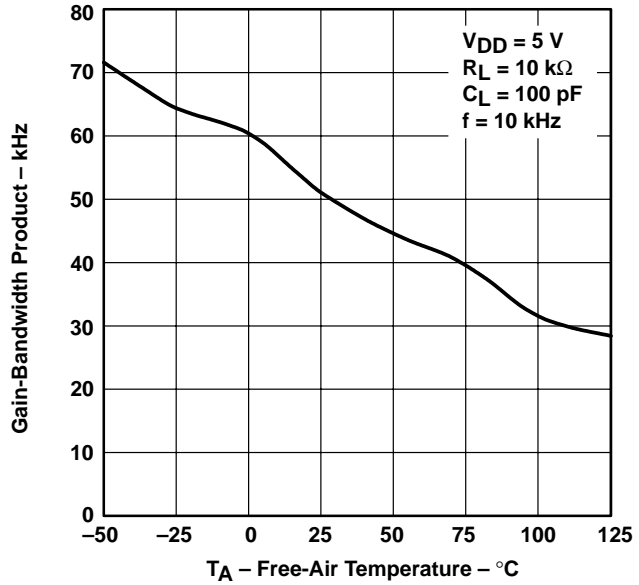
**TYPICAL CHARACTERISTICS**

**GAIN-BANDWIDTH PRODUCT**  
**vs**  
**SUPPLY VOLTAGE**



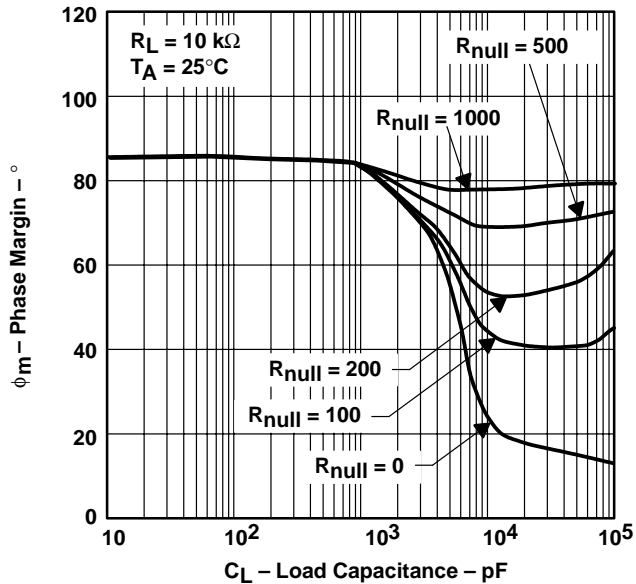
**Figure 46**

**GAIN-BANDWIDTH PRODUCT**  
**vs**  
**FREE-AIR TEMPERATURE**



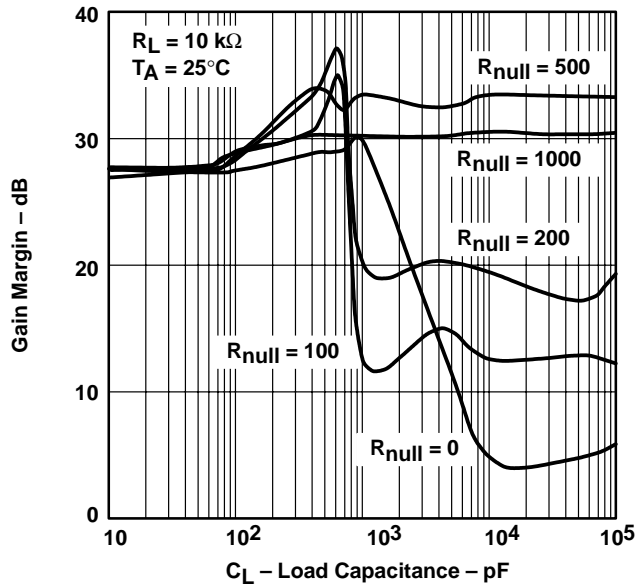
**Figure 47**

**PHASE MARGIN**  
**vs**  
**LOAD CAPACITANCE**



**Figure 48**

**GAIN MARGIN**  
**vs**  
**LOAD CAPACITANCE**



**Figure 49**

TYPICAL CHARACTERISTICS

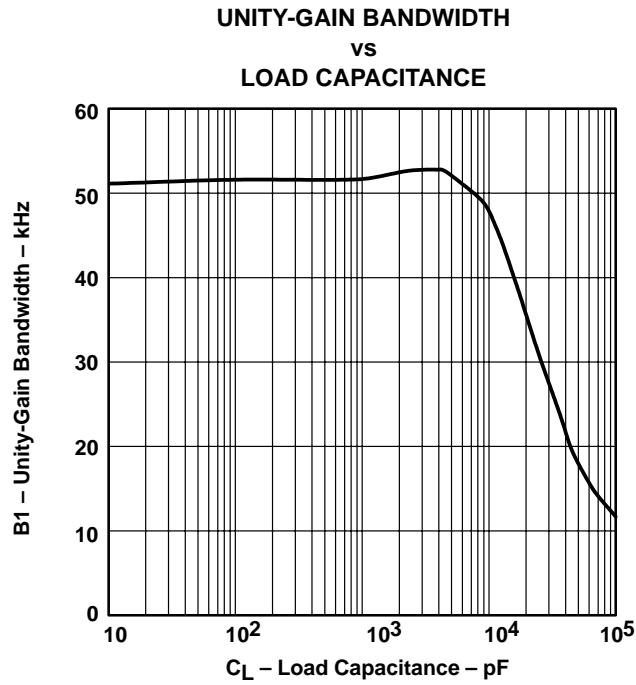


Figure 50

**PACKAGING INFORMATION**

Orderable Device	Status (1)	Package Type	Package Drawing	Pins	Package Qty	Eco Plan (2)	Lead/Ball Finish (6)	MSL Peak Temp (3)	Op Temp (°C)	Device Marking (4/5)	Samples
5962-9751401QHA	ACTIVE	CFP	U	10	1	TBD	A42	N / A for Pkg Type	-55 to 125	9751401QHA TLV2422M	<a href="#">Samples</a>
5962-9751402QHA	NRND	CFP	U	10	1	TBD	A42	N / A for Pkg Type	-55 to 125	9751402QHA TLV2422AM	
TLV2422AID	ACTIVE	SOIC	D	8	75	Green (RoHS & no Sb/Br)	CU NIPDAU	Level-1-260C-UNLIM	-40 to 85	2422AI	<a href="#">Samples</a>
TLV2422AIDR	ACTIVE	SOIC	D	8	2500	Green (RoHS & no Sb/Br)	CU NIPDAU	Level-1-260C-UNLIM	-40 to 85	2422AI	<a href="#">Samples</a>
TLV2422AIPWLE	OBSOLETE	TSSOP	PW	8		TBD	Call TI	Call TI	-40 to 85		
TLV2422AIPWR	ACTIVE	TSSOP	PW	8	2000	Green (RoHS & no Sb/Br)	CU NIPDAU	Level-1-260C-UNLIM	-40 to 85	2422AI	<a href="#">Samples</a>
TLV2422AMUB	NRND	CFP	U	10	1	TBD	A42	N / A for Pkg Type	-55 to 125	9751402QHA TLV2422AM	
TLV2422AQD	OBSOLETE	SOIC	D	8		TBD	Call TI	Call TI	-40 to 125		
TLV2422AQDR	OBSOLETE	SOIC	D	8		TBD	Call TI	Call TI	-40 to 125		
TLV2422CD	ACTIVE	SOIC	D	8	75	Green (RoHS & no Sb/Br)	CU NIPDAU	Level-1-260C-UNLIM	0 to 70	2422C	<a href="#">Samples</a>
TLV2422CDG4	ACTIVE	SOIC	D	8	75	Green (RoHS & no Sb/Br)	CU NIPDAU	Level-1-260C-UNLIM	0 to 70	2422C	<a href="#">Samples</a>
TLV2422CDR	ACTIVE	SOIC	D	8	2500	Green (RoHS & no Sb/Br)	CU NIPDAU	Level-1-260C-UNLIM	0 to 70	2422C	<a href="#">Samples</a>
TLV2422CPWR	ACTIVE	TSSOP	PW	8	2000	Green (RoHS & no Sb/Br)	CU NIPDAU	Level-1-260C-UNLIM	0 to 70	TV2422	<a href="#">Samples</a>
TLV2422CPWRG4	ACTIVE	TSSOP	PW	8	2000	Green (RoHS & no Sb/Br)	CU NIPDAU	Level-1-260C-UNLIM	0 to 70	TV2422	<a href="#">Samples</a>
TLV2422ID	ACTIVE	SOIC	D	8	75	Green (RoHS & no Sb/Br)	CU NIPDAU	Level-1-260C-UNLIM	-40 to 85	2422I	<a href="#">Samples</a>
TLV2422IDG4	ACTIVE	SOIC	D	8	75	Green (RoHS & no Sb/Br)	CU NIPDAU	Level-1-260C-UNLIM	-40 to 85	2422I	<a href="#">Samples</a>
TLV2422IDR	ACTIVE	SOIC	D	8	2500	Green (RoHS & no Sb/Br)	CU NIPDAU	Level-1-260C-UNLIM	-40 to 85	2422I	<a href="#">Samples</a>
TLV2422IDRG4	ACTIVE	SOIC	D	8	2500	Green (RoHS & no Sb/Br)	CU NIPDAU	Level-1-260C-UNLIM	-40 to 85	2422I	<a href="#">Samples</a>
TLV2422IPW	OBSOLETE	TSSOP	PW	8		TBD	Call TI	Call TI	-40 to 85		

Orderable Device	Status (1)	Package Type	Package Drawing	Pins	Package Qty	Eco Plan (2)	Lead/Ball Finish (6)	MSL Peak Temp (3)	Op Temp (°C)	Device Marking (4/5)	Samples
TLV2422IPWR	OBSOLETE	TSSOP	PW	8		TBD	Call TI	Call TI	-40 to 85		
TLV2422MUB	ACTIVE	CFP	U	10	1	TBD	A42	N / A for Pkg Type	-55 to 125	9751401QHA TLV2422M	Samples

(1) The marketing status values are defined as follows:

**ACTIVE:** Product device recommended for new designs.

**LIFEBUY:** TI has announced that the device will be discontinued, and a lifetime-buy period is in effect.

**NRND:** Not recommended for new designs. Device is in production to support existing customers, but TI does not recommend using this part in a new design.

**PREVIEW:** Device has been announced but is not in production. Samples may or may not be available.

**OBSOLETE:** TI has discontinued the production of the device.

(2) Eco Plan - The planned eco-friendly classification: Pb-Free (RoHS), Pb-Free (RoHS Exempt), or Green (RoHS & no Sb/Br) - please check <http://www.ti.com/productcontent> for the latest availability information and additional product content details.

**TBD:** The Pb-Free/Green conversion plan has not been defined.

**Pb-Free (RoHS):** TI's terms "Lead-Free" or "Pb-Free" mean semiconductor products that are compatible with the current RoHS requirements for all 6 substances, including the requirement that lead not exceed 0.1% by weight in homogeneous materials. Where designed to be soldered at high temperatures, TI Pb-Free products are suitable for use in specified lead-free processes.

**Pb-Free (RoHS Exempt):** This component has a RoHS exemption for either 1) lead-based flip-chip solder bumps used between the die and package, or 2) lead-based die adhesive used between the die and leadframe. The component is otherwise considered Pb-Free (RoHS compatible) as defined above.

**Green (RoHS & no Sb/Br):** TI defines "Green" to mean Pb-Free (RoHS compatible), and free of Bromine (Br) and Antimony (Sb) based flame retardants (Br or Sb do not exceed 0.1% by weight in homogeneous material)

(3) MSL, Peak Temp. - The Moisture Sensitivity Level rating according to the JEDEC industry standard classifications, and peak solder temperature.

(4) There may be additional marking, which relates to the logo, the lot trace code information, or the environmental category on the device.

(5) Multiple Device Markings will be inside parentheses. Only one Device Marking contained in parentheses and separated by a "~" will appear on a device. If a line is indented then it is a continuation of the previous line and the two combined represent the entire Device Marking for that device.

(6) Lead/Ball Finish - Orderable Devices may have multiple material finish options. Finish options are separated by a vertical ruled line. Lead/Ball Finish values may wrap to two lines if the finish value exceeds the maximum column width.

**Important Information and Disclaimer:** The information provided on this page represents TI's knowledge and belief as of the date that it is provided. TI bases its knowledge and belief on information provided by third parties, and makes no representation or warranty as to the accuracy of such information. Efforts are underway to better integrate information from third parties. TI has taken and continues to take reasonable steps to provide representative and accurate information but may not have conducted destructive testing or chemical analysis on incoming materials and chemicals. TI and TI suppliers consider certain information to be proprietary, and thus CAS numbers and other limited information may not be available for release.

In no event shall TI's liability arising out of such information exceed the total purchase price of the TI part(s) at issue in this document sold by TI to Customer on an annual basis.

**OTHER QUALIFIED VERSIONS OF TLV2422, TLV2422A, TLV2422AM, TLV2422M :**

- Catalog: [TLV2422A](#), [TLV2422](#)
- Automotive: [TLV2422-Q1](#), [TLV2422A-Q1](#), [TLV2422A-Q1](#), [TLV2422-Q1](#)
- Military: [TLV2422M](#), [TLV2422AM](#)

## NOTE: Qualified Version Definitions:

- Catalog - TI's standard catalog product
- Automotive - Q100 devices qualified for high-reliability automotive applications targeting zero defects
- Military - QML certified for Military and Defense Applications



**TAPE AND REEL INFORMATION**
**REEL DIMENSIONS**

**TAPE DIMENSIONS**


A0	Dimension designed to accommodate the component width
B0	Dimension designed to accommodate the component length
K0	Dimension designed to accommodate the component thickness
W	Overall width of the carrier tape
P1	Pitch between successive cavity centers

**TAPE AND REEL INFORMATION**

\*All dimensions are nominal

Device	Package Type	Package Drawing	Pins	SPQ	Reel Diameter (mm)	Reel Width W1 (mm)	A0 (mm)	B0 (mm)	K0 (mm)	P1 (mm)	W (mm)	Pin1 Quadrant
TLV2422AIDR	SOIC	D	8	2500	330.0	12.4	6.4	5.2	2.1	8.0	12.0	Q1
TLV2422AIPWR	TSSOP	PW	8	2000	330.0	12.4	7.0	3.6	1.6	8.0	12.0	Q1
TLV2422CDR	SOIC	D	8	2500	330.0	12.4	6.4	5.2	2.1	8.0	12.0	Q1
TLV2422CPWR	TSSOP	PW	8	2000	330.0	12.4	7.0	3.6	1.6	8.0	12.0	Q1
TLV2422IDR	SOIC	D	8	2500	330.0	12.4	6.4	5.2	2.1	8.0	12.0	Q1

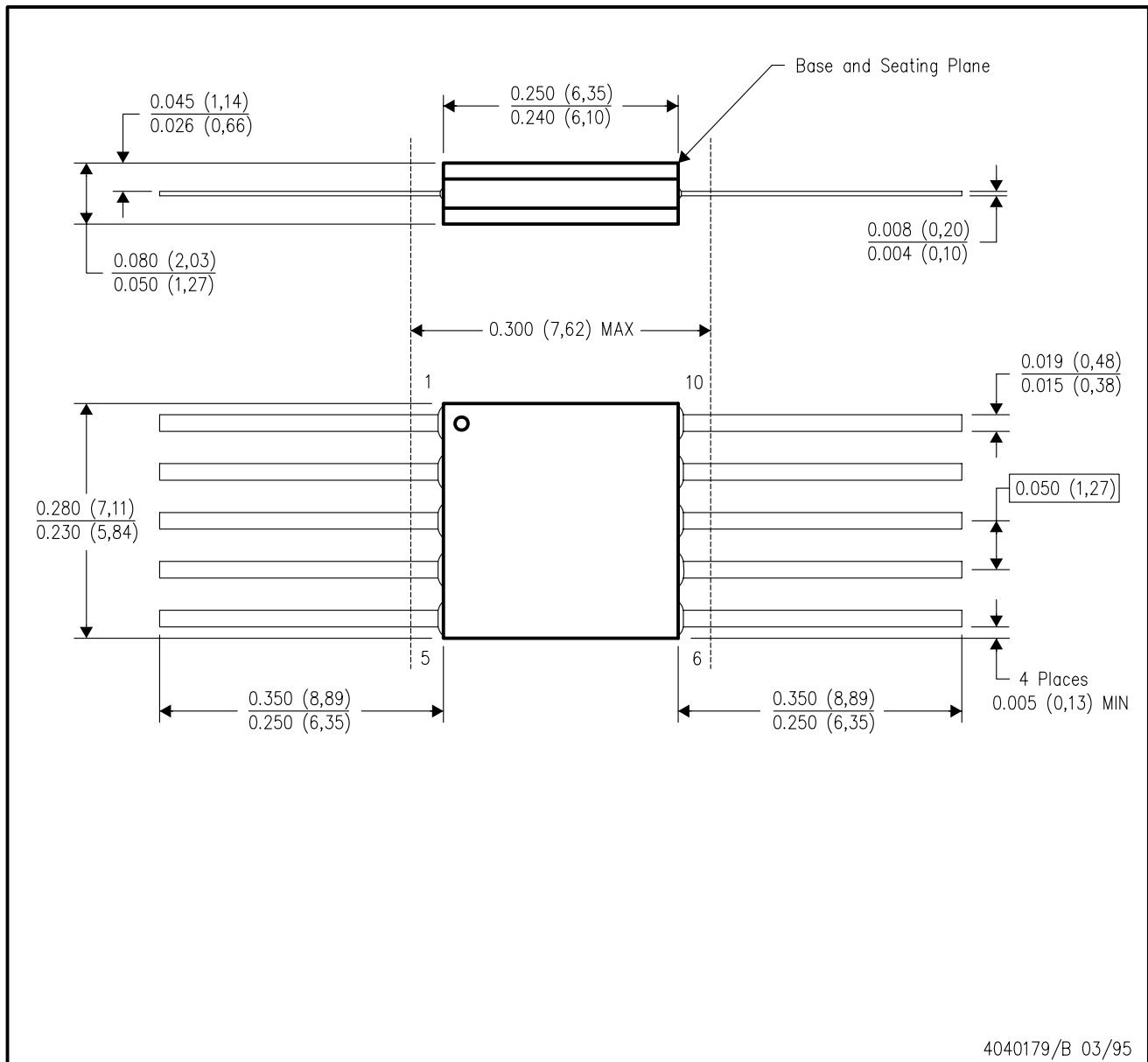
**TAPE AND REEL BOX DIMENSIONS**


\*All dimensions are nominal

Device	Package Type	Package Drawing	Pins	SPQ	Length (mm)	Width (mm)	Height (mm)
TLV2422AIDR	SOIC	D	8	2500	340.5	338.1	20.6
TLV2422AIPWR	TSSOP	PW	8	2000	367.0	367.0	35.0
TLV2422CDR	SOIC	D	8	2500	340.5	338.1	20.6
TLV2422CPWR	TSSOP	PW	8	2000	367.0	367.0	35.0
TLV2422IDR	SOIC	D	8	2500	340.5	338.1	20.6

U (S-GDFP-F10)

CERAMIC DUAL FLATPACK



4040179/B 03/95

- NOTES:
- A. All linear dimensions are in inches (millimeters).
  - B. This drawing is subject to change without notice.
  - C. This package can be hermetically sealed with a ceramic lid using glass frit.
  - D. Index point is provided on cap for terminal identification only.
  - E. Falls within MIL STD 1835 GDFP1-F10 and JEDEC MO-092AA

PW0008A



# PACKAGE OUTLINE

## TSSOP - 1.2 mm max height

SMALL OUTLINE PACKAGE



4221848/A 02/2015

NOTES:

- All linear dimensions are in millimeters. Any dimensions in parenthesis are for reference only. Dimensioning and tolerancing per ASME Y14.5M.
- This drawing is subject to change without notice.
- This dimension does not include mold flash, protrusions, or gate burrs. Mold flash, protrusions, or gate burrs shall not exceed 0.15 mm per side.
- This dimension does not include interlead flash. Interlead flash shall not exceed 0.25 mm per side.
- Reference JEDEC registration MO-153, variation AA.

# EXAMPLE BOARD LAYOUT

PW0008A

TSSOP - 1.2 mm max height

SMALL OUTLINE PACKAGE



LAND PATTERN EXAMPLE  
SCALE:10X



SOLDER MASK DETAILS  
NOT TO SCALE

4221848/A 02/2015

NOTES: (continued)

- 6. Publication IPC-7351 may have alternate designs.
- 7. Solder mask tolerances between and around signal pads can vary based on board fabrication site.

# EXAMPLE STENCIL DESIGN

PW0008A

TSSOP - 1.2 mm max height

SMALL OUTLINE PACKAGE



SOLDER PASTE EXAMPLE  
BASED ON 0.125 mm THICK STENCIL  
SCALE:10X

4221848/A 02/2015



NOTES: (continued)

8. Laser cutting apertures with trapezoidal walls and rounded corners may offer better paste release. IPC-7525 may have alternate design recommendations.
9. Board assembly site may have different recommendations for stencil design.

D (R-PDSO-G8)

PLASTIC SMALL OUTLINE



- NOTES:
- A. All linear dimensions are in inches (millimeters).
  - B. This drawing is subject to change without notice.
  -  Body length does not include mold flash, protrusions, or gate burrs. Mold flash, protrusions, or gate burrs shall not exceed 0.006 (0,15) each side.
  -  Body width does not include interlead flash. Interlead flash shall not exceed 0.017 (0,43) each side.
  - E. Reference JEDEC MS-012 variation AA.

D (R-PDSO-G8)

PLASTIC SMALL OUTLINE



- NOTES:
- A. All linear dimensions are in millimeters.
  - B. This drawing is subject to change without notice.
  - C. Publication IPC-7351 is recommended for alternate designs.
  - D. Laser cutting apertures with trapezoidal walls and also rounding corners will offer better paste release. Customers should contact their board assembly site for stencil design recommendations. Refer to IPC-7525 for other stencil recommendations.
  - E. Customers should contact their board fabrication site for solder mask tolerances between and around signal pads.



## IMPORTANT NOTICE

Texas Instruments Incorporated and its subsidiaries (TI) reserve the right to make corrections, enhancements, improvements and other changes to its semiconductor products and services per JESD46, latest issue, and to discontinue any product or service per JESD48, latest issue. Buyers should obtain the latest relevant information before placing orders and should verify that such information is current and complete. All semiconductor products (also referred to herein as "components") are sold subject to TI's terms and conditions of sale supplied at the time of order acknowledgment.

TI warrants performance of its components to the specifications applicable at the time of sale, in accordance with the warranty in TI's terms and conditions of sale of semiconductor products. Testing and other quality control techniques are used to the extent TI deems necessary to support this warranty. Except where mandated by applicable law, testing of all parameters of each component is not necessarily performed.

TI assumes no liability for applications assistance or the design of Buyers' products. Buyers are responsible for their products and applications using TI components. To minimize the risks associated with Buyers' products and applications, Buyers should provide adequate design and operating safeguards.

TI does not warrant or represent that any license, either express or implied, is granted under any patent right, copyright, mask work right, or other intellectual property right relating to any combination, machine, or process in which TI components or services are used. Information published by TI regarding third-party products or services does not constitute a license to use such products or services or a warranty or endorsement thereof. Use of such information may require a license from a third party under the patents or other intellectual property of the third party, or a license from TI under the patents or other intellectual property of TI.

Reproduction of significant portions of TI information in TI data books or data sheets is permissible only if reproduction is without alteration and is accompanied by all associated warranties, conditions, limitations, and notices. TI is not responsible or liable for such altered documentation. Information of third parties may be subject to additional restrictions.

Resale of TI components or services with statements different from or beyond the parameters stated by TI for that component or service voids all express and any implied warranties for the associated TI component or service and is an unfair and deceptive business practice. TI is not responsible or liable for any such statements.

Buyer acknowledges and agrees that it is solely responsible for compliance with all legal, regulatory and safety-related requirements concerning its products, and any use of TI components in its applications, notwithstanding any applications-related information or support that may be provided by TI. Buyer represents and agrees that it has all the necessary expertise to create and implement safeguards which anticipate dangerous consequences of failures, monitor failures and their consequences, lessen the likelihood of failures that might cause harm and take appropriate remedial actions. Buyer will fully indemnify TI and its representatives against any damages arising out of the use of any TI components in safety-critical applications.

In some cases, TI components may be promoted specifically to facilitate safety-related applications. With such components, TI's goal is to help enable customers to design and create their own end-product solutions that meet applicable functional safety standards and requirements. Nonetheless, such components are subject to these terms.

No TI components are authorized for use in FDA Class III (or similar life-critical medical equipment) unless authorized officers of the parties have executed a special agreement specifically governing such use.

Only those TI components which TI has specifically designated as military grade or "enhanced plastic" are designed and intended for use in military/aerospace applications or environments. Buyer acknowledges and agrees that any military or aerospace use of TI components which have **not** been so designated is solely at the Buyer's risk, and that Buyer is solely responsible for compliance with all legal and regulatory requirements in connection with such use.

TI has specifically designated certain components as meeting ISO/TS16949 requirements, mainly for automotive use. In any case of use of non-designated products, TI will not be responsible for any failure to meet ISO/TS16949.

### Products

Audio	<a href="http://www.ti.com/audio">www.ti.com/audio</a>
Amplifiers	<a href="http://amplifier.ti.com">amplifier.ti.com</a>
Data Converters	<a href="http://dataconverter.ti.com">dataconverter.ti.com</a>
DLP® Products	<a href="http://www.dlp.com">www.dlp.com</a>
DSP	<a href="http://dsp.ti.com">dsp.ti.com</a>
Clocks and Timers	<a href="http://www.ti.com/clocks">www.ti.com/clocks</a>
Interface	<a href="http://interface.ti.com">interface.ti.com</a>
Logic	<a href="http://logic.ti.com">logic.ti.com</a>
Power Mgmt	<a href="http://power.ti.com">power.ti.com</a>
Microcontrollers	<a href="http://microcontroller.ti.com">microcontroller.ti.com</a>
RFID	<a href="http://www.ti-rfid.com">www.ti-rfid.com</a>
OMAP Applications Processors	<a href="http://www.ti.com/omap">www.ti.com/omap</a>
Wireless Connectivity	<a href="http://www.ti.com/wirelessconnectivity">www.ti.com/wirelessconnectivity</a>

### Applications

Automotive and Transportation	<a href="http://www.ti.com/automotive">www.ti.com/automotive</a>
Communications and Telecom	<a href="http://www.ti.com/communications">www.ti.com/communications</a>
Computers and Peripherals	<a href="http://www.ti.com/computers">www.ti.com/computers</a>
Consumer Electronics	<a href="http://www.ti.com/consumer-apps">www.ti.com/consumer-apps</a>
Energy and Lighting	<a href="http://www.ti.com/energy">www.ti.com/energy</a>
Industrial	<a href="http://www.ti.com/industrial">www.ti.com/industrial</a>
Medical	<a href="http://www.ti.com/medical">www.ti.com/medical</a>
Security	<a href="http://www.ti.com/security">www.ti.com/security</a>
Space, Avionics and Defense	<a href="http://www.ti.com/space-avionics-defense">www.ti.com/space-avionics-defense</a>
Video and Imaging	<a href="http://www.ti.com/video">www.ti.com/video</a>

### TI E2E Community

[e2e.ti.com](http://e2e.ti.com)