

National Semiconductor is now part of
Texas Instruments.

Search <http://www.ti.com/> for the latest technical
information and details on our current products and services.

LP2981

Micropower 100 mA Ultra Low-Dropout Regulator in SOT-23 Package

General Description

The LP2981 is a 100 mA, fixed-output voltage regulator designed specifically to meet the requirements of battery-powered applications.

Using an optimized VIP® (Vertically Integrated PNP) process, the LP2981 delivers unequaled performance in all specifications critical to battery-powered designs:

Dropout Voltage. Typically 200 mV @ 100 mA load, and 7 mV @ 1 mA load.

Ground Pin Current. Typically 600 μ A @ 100 mA load, and 80 μ A @ 1 mA load.

Sleep Mode. Less than 1 μ A quiescent current when ON/OFF pin is pulled low.

Precision Output. 0.75% tolerance output voltages available (A grade).

Nine voltage options, from 2.5V to 5.0V, are available as standard products.

Features

- Ultra low dropout voltage
- Output voltage accuracy 0.75% (A Grade)
- Guaranteed 100 mA output current
- < 1 μ A quiescent current when shutdown
- Low ground pin current at all load currents
- High peak current capability (300 mA typical)
- Wide supply voltage range (16V max)
- Fast dynamic response to line and load
- Low Z_{OUT} over wide frequency range
- Overtemperature/overcurrent protection
- -40°C to $+125^{\circ}\text{C}$ junction temperature range

Applications

- Cellular Phone
- Palmtop/Laptop Computer
- Personal Digital Assistant (PDA)
- Camcorder, Personal Stereo, Camera

Block Diagram

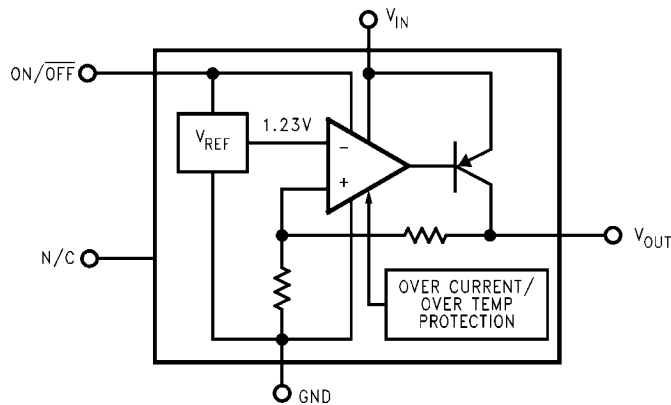

1250601

Connection Diagram

5-Lead Small Outline Package (SOT-23)

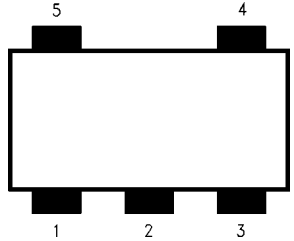

Top View
See NS Package Number MF05A

1250602

Pin Descriptions

Name	Pin Number	Function
V_{IN}	1	Input Voltage
GND	2	Common Ground (device substrate)
ON/OFF	3	Logic high enable input
N/C	4	Post package trim - do not connect to this pin
V_{OUT}	5	Regulated output voltage

Ordering Information

TABLE 1. Package Marking and Order Information

Output Voltage (V)	Grade	Order Information	Package Marking	Supplied as:
2.5	A	LP2981AIM5X-2.5	L0CA	3000 Units on Tape and Reel
		LP2981AIM5-2.5	L0CA	1000 Units on Tape and Reel
	STD	LP2981IM5X-2.5	L0CB	3000 Units on Tape and Reel
		LP2981IM5-2.5	L0CB	1000 Units on Tape and Reel
2.7	A	LP2981AIM5X-2.7	L0DA	3000 Units on Tape and Reel
		LP2981AIM5-2.7	L0DA	1000 Units on Tape and Reel
	STD	LP2981IM5-2.7	L0DB	1000 Units on Tape and Reel
2.8	A	LP2981AIM5X-2.8	L77A	3000 Units on Tape and Reel
		LP2981AIM5-2.8	L77A	1000 Units on Tape and Reel
	STD	LP2981IM5X-2.8	L77B	3000 Units on Tape and Reel
		LP2981IM5-2.8	L77B	1000 Units on Tape and Reel
3.0	A	LP2981AIM5X-3.0	L05A	3000 Units on Tape and Reel
		LP2981AIM5-3.0	L05A	1000 Units on Tape and Reel
	STD	LP2981IM5X-3.0	L05B	3000 Units on Tape and Reel
		LP2981IM5-3.0	L05B	1000 Units on Tape and Reel
3.2	A	LP2981AIM5X-3.2	L35A	3000 Units on Tape and Reel
3.3	A	LP2981AIM5X-3.3	L04A	3000 Units on Tape and Reel
		LP2981AIM5-3.3	L04A	1000 Units on Tape and Reel
	STD	LP2981IM5X-3.3	L04B	3000 Units on Tape and Reel
		LP2981IM5-3.3	L04B	1000 Units on Tape and Reel
3.6	A	LP2981AIM5X-3.6	L0JA	3000 Units on Tape and Reel
		LP2981AIM5-3.6	L0JA	1000 Units on Tape and Reel
	STD	LP2981IM5X-3.6	L0JB	3000 Units on Tape and Reel
		LP2981IM5-3.6	L0JB	1000 Units on Tape and Reel
3.8	A	LP2981AIM5-3.8	L36A	1000 Units on Tape and Reel
	STD	LP2981IM5-3.8	L36B	1000 Units on Tape and Reel
5.0	A	LP2981AIM5X-5.0	L03A	3000 Units on Tape and Reel
		LP2981AIM5-5.0	L03A	1000 Units on Tape and Reel
	STD	LP2981IM5X-5.0	L03B	3000 Units on Tape and Reel
		LP2981IM5-5.0	L03B	1000 Units on Tape and Reel

Absolute Maximum Ratings (Note 1)

If Military/Aerospace specified devices are required, please contact the National Semiconductor Sales Office/Distributors for availability and specifications.

Storage Temperature Range	-65°C to +150°C
Operating Junction Temperature Range	-40°C to +125°C
Lead Temperature (Soldering, 5 sec.)	260°C

ESD Rating (Note 2)	2 kV
Power Dissipation (Note 3)	Internally Limited
Input Supply Voltage (Survival)	-0.3V to +16V
Input Supply Voltage (Operating)	2.1V to +16V
Shutdown Input Voltage (Survival)	-0.3V to +16V
Output Voltage (Survival, (Note 4))	-0.3V to +9V
I _{OUT} (Survival)	Short Circuit Protected
Input-Output Voltage (Survival, (Note 5))	-0.3V to +16V

Electrical Characteristics

Limits in standard typeface are for T_J = 25°C, and limits in **boldface type** apply over the full operating temperature range. Unless otherwise specified: V_{IN} = V_{O(NOM)} + 1V, C_{IN} = 1 μF, I_L = 1 mA, C_{OUT} = 4.7 μF, V_{ON/OFF} = 2V.

Symbol	Parameter	Conditions	Typ	LP2981AI-XX (Note 6)		LP2981I-XX (Note 6)		Units
				Min	Max	Min	Max	
				ΔV _O	Output Voltage Tolerance	I _L = 1 mA 1 mA < I _L < 100 mA		
$\frac{\Delta V_O}{\Delta V_{IN}}$	Output Voltage Line Regulation	V _{O(NOM)} + 1V ≤ V _{IN} ≤ 16V	0.007		0.014 0.032		0.014 0.032	%/V
V _{IN} -V _O	Dropout Voltage (Note 7)	I _L = 0 I _L = 1 mA I _L = 25 mA I _L = 100 mA	1 7 70 200		3 5 10 15 100 150 250 375		3 5 100 150 250 375	mV
I _{GND}	Ground Pin Current	I _L = 0 I _L = 1 mA I _L = 25 mA I _L = 100 mA V _{ON/OFF} < 0.3V V _{ON/OFF} < 0.15V	65 80 200 600 0.01 0.05		95 125 110 170 300 550 800 1500 0.8 2		95 125 110 170 300 550 800 1500 0.8 2	μA
V _{ON/OFF}	ON/OFF Input Voltage (Note 8)	High = O/P ON Low = O/P OFF	1.4 0.50	1.6		1.6		V
I _{ON/OFF}	ON/OFF Input Current	V _{ON/OFF} = 0 V _{ON/OFF} = 5V	0.01 5		-1 15		-1 15	μA
I _{O(PK)}	Peak Output Current	V _{OUT} ≥ V _{O(NOM)} - 5%	400	150		150		mA
e _n	Output Noise Voltage (RMS)	BW = 300 Hz-50 kHz, C _{OUT} = 10 μF	160					μV
$\frac{\Delta V_{OUT}}{\Delta V_{IN}}$	Ripple Rejection	f = 1 kHz C _{OUT} = 10 μF	63					dB
I _{O(MAX)}	Short Circuit Current	R _L = 0 (Steady State) (Note 9)	150					mA

Note 1: Absolute maximum ratings indicate limits beyond which damage to the component may occur. Electrical specifications do not apply when operating the device outside of its rated operating conditions.

Note 2: The ESD rating of pins 3 and 4 for the SOT-23 package is 1 kV.

Note 3: The maximum allowable power dissipation is a function of the maximum junction temperature, $T_{J(MAX)}$, the junction-to-ambient thermal resistance, θ_{JA} , and the ambient temperature, T_A . The maximum allowable power dissipation at any ambient temperature is calculated using:

$$P (MAX) = \frac{T_{J(MAX)} - T_A}{\theta_{JA}}$$

The value of θ_{JA} for the SOT-23 package is 220°C/W. Exceeding the maximum allowable power dissipation will cause excessive die temperature, and the regulator will go into thermal shutdown.

Note 4: If used in a dual-supply system where the regulator load is returned to a negative supply, the LP2981 output must be diode-clamped to ground.

Note 5: The output PNP structure contains a diode between the V_{IN} and V_{OUT} terminals that is normally reverse-biased. Reversing the polarity from V_{IN} to V_{OUT} will turn on this diode (see Application Hints).

Note 6: Limits are 100% production tested at 25°C. Limits over the operating temperature range are guaranteed through correlation using Statistical Quality Control (SQC) methods. The limits are used to calculate National's Average Outgoing Quality Level (AOQL).

Note 7: Dropout voltage is defined as the input to output differential at which the output voltage drops 100 mV below the value measured with a 1V differential.

Note 8: The ON/OFF inputs must be properly driven to prevent misoperation. For details, refer to Application Hints.

Note 9: See *Typical Performance Characteristics* curve(s).

Typical Application Circuit

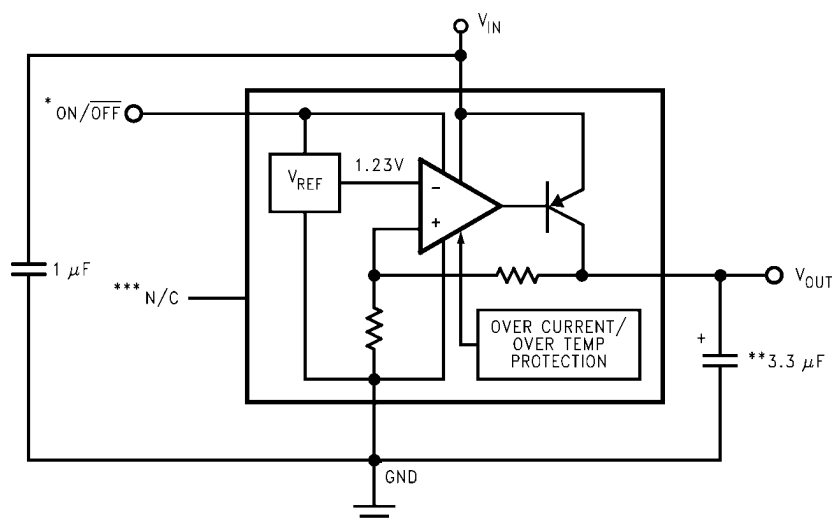

1250604

*ON/OFF input must be actively terminated. Tie to V_{IN} if this function is not to be used.

**Minimum Output Capacitance is shown to insure stability over full load current range. More capacitance provides superior dynamic performance and additional stability margin (see Application Hints).

***Do not make connections to this pin.

Typical Performance Characteristics Unless otherwise specified: $T_A = 25^\circ\text{C}$, $V_{IN} = V_{O(NOM)} + 1\text{V}$, $C_{OUT} = 4.7\ \mu\text{F}$, $C_{IN} = 1\ \mu\text{F}$ all voltage options, ON/OFF pin tied to V_{IN} .

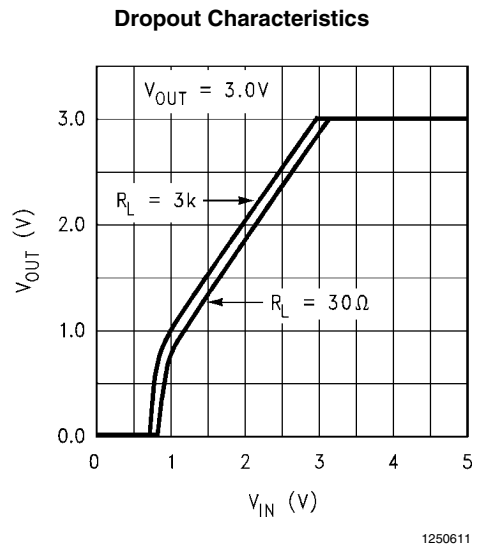
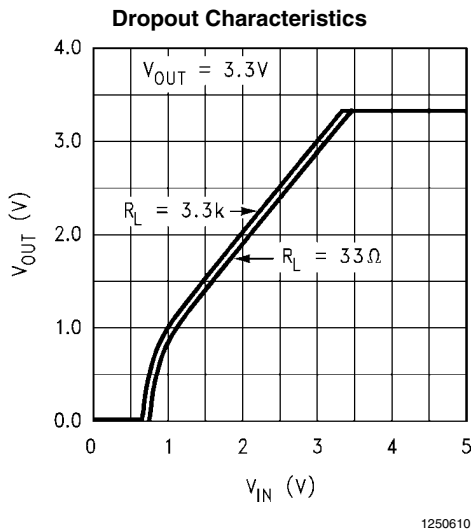
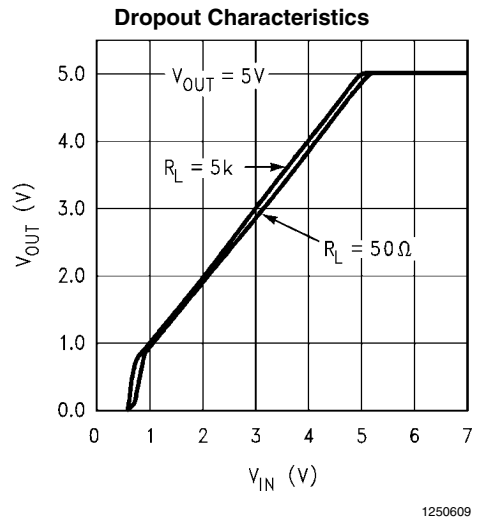
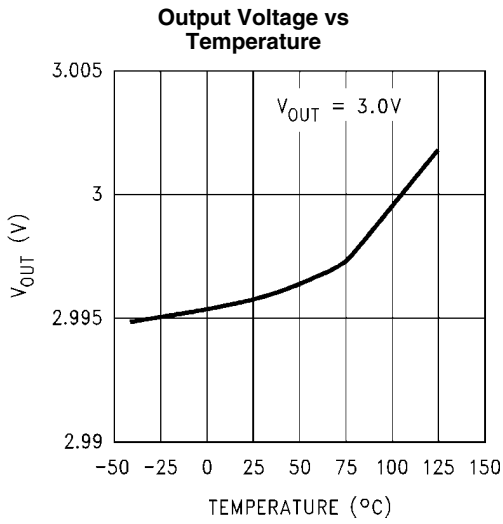
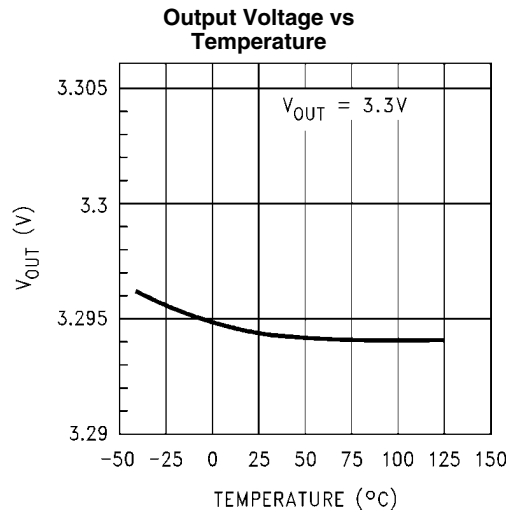
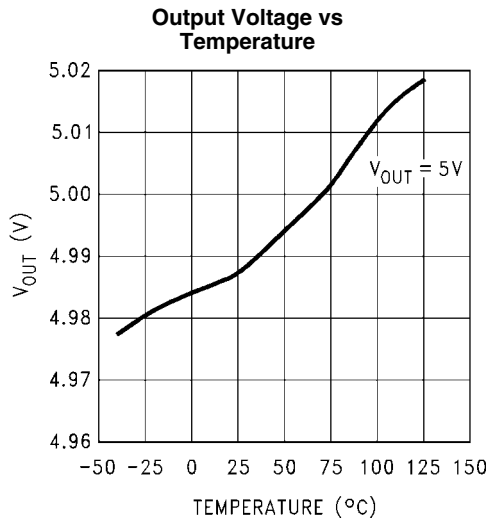

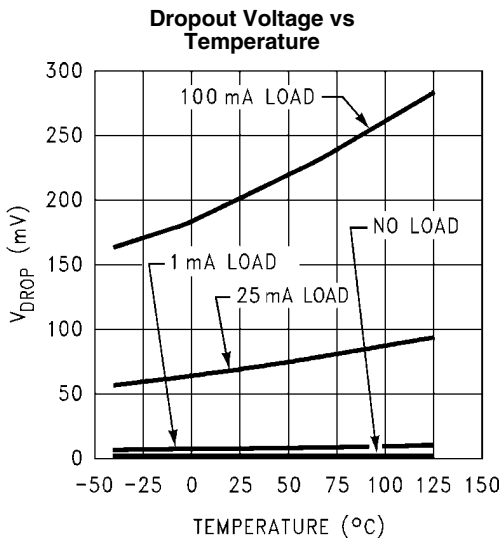

1250612

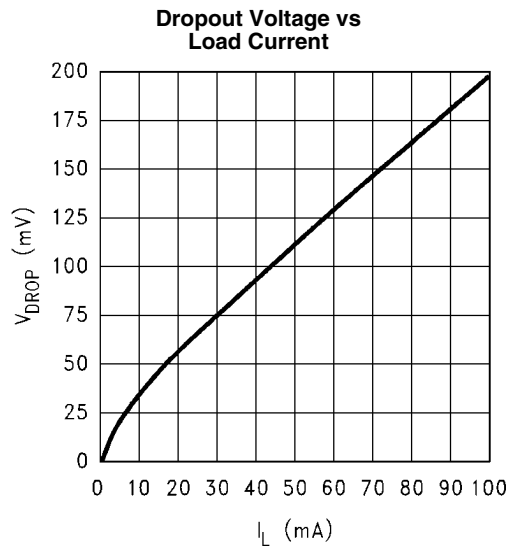

1250613

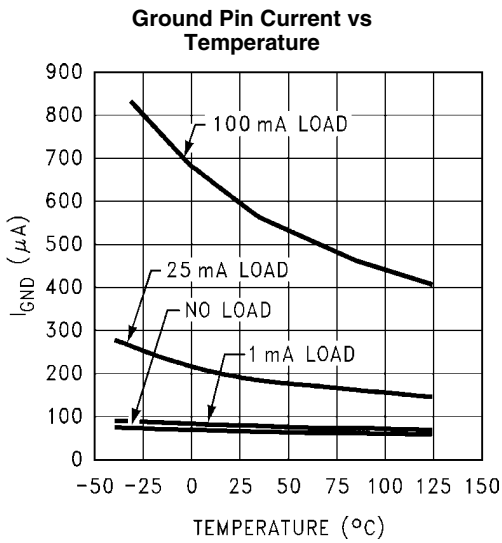

1250614

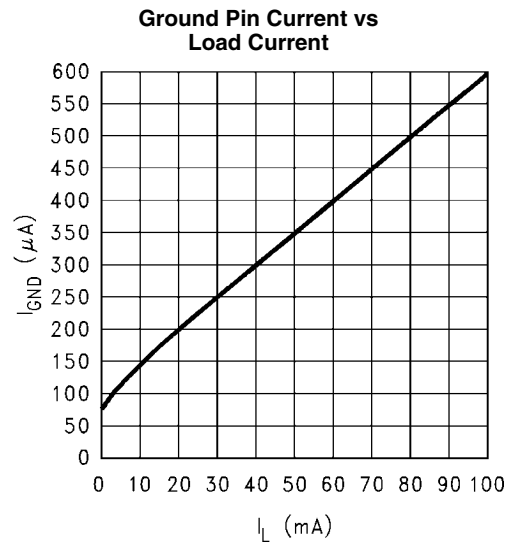

1250615

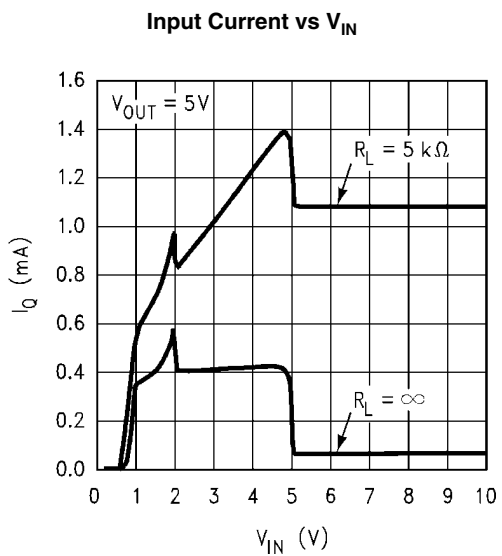

1250616

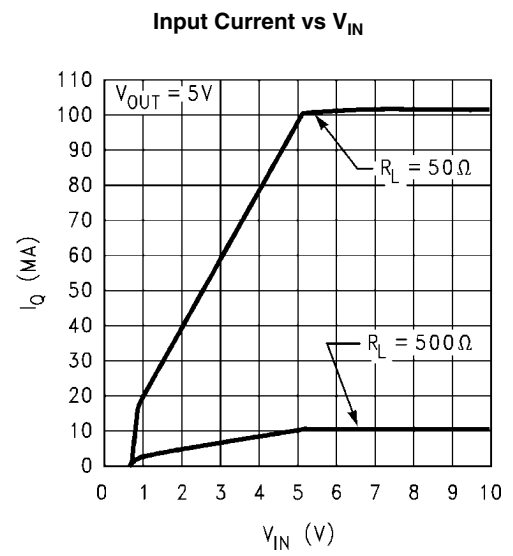

1250617

Line Transient Response

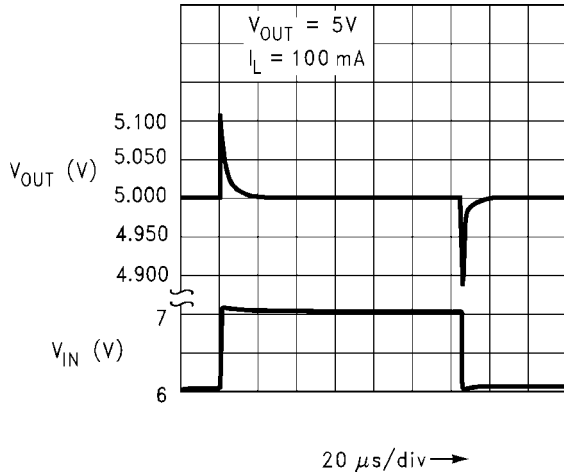

1250618

Line Transient Response

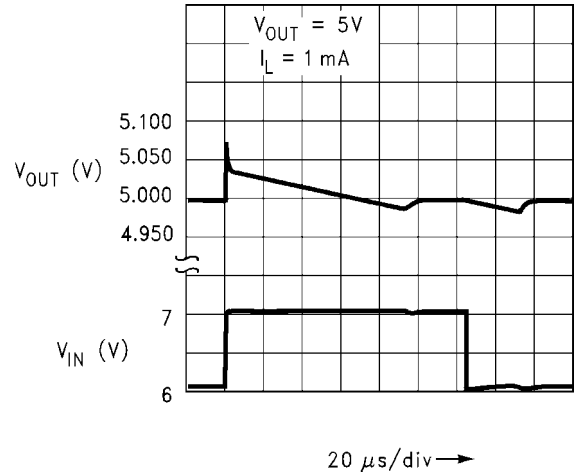

1250619

Load Transient Response

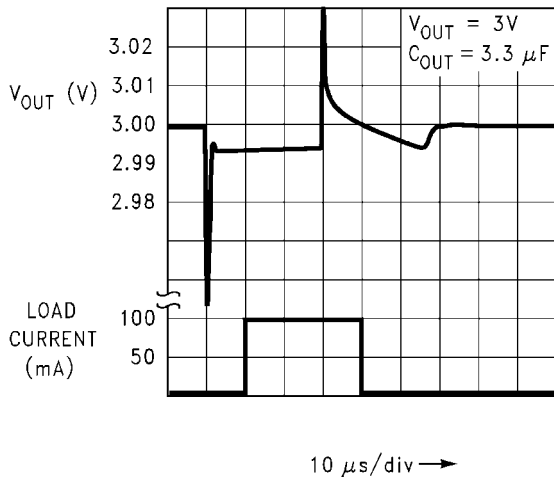

1250620

Load Transient Response

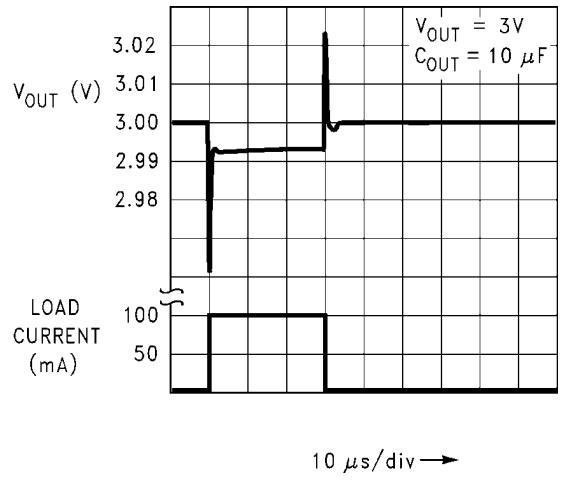

1250621

Load Transient Response

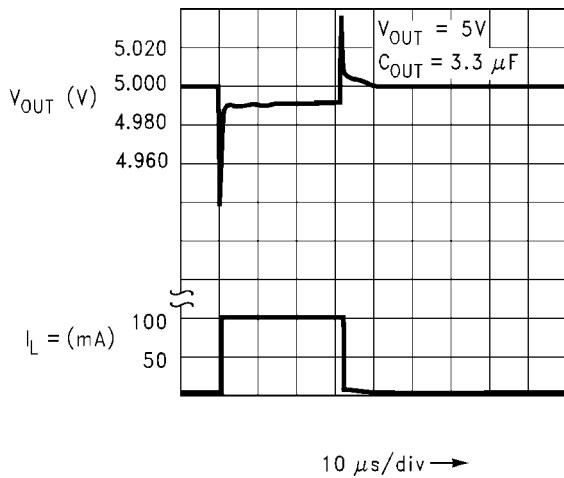

1250622

Load Transient Response

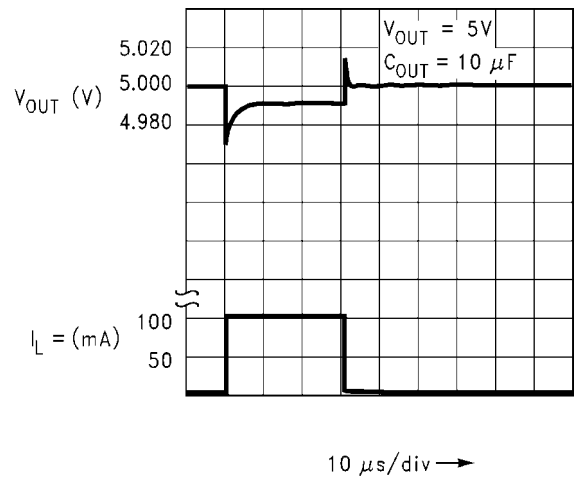

1250623

Short Circuit Current

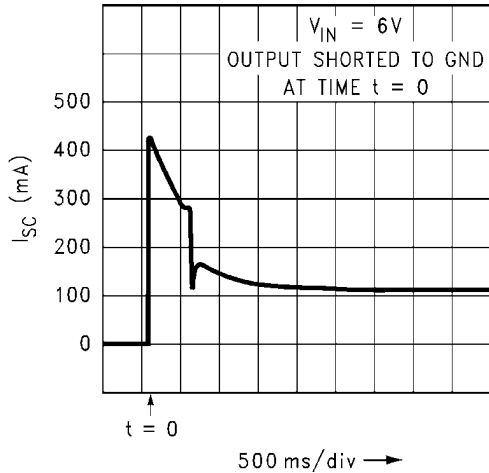

1250624

Instantaneous Short Circuit Current vs Temperature

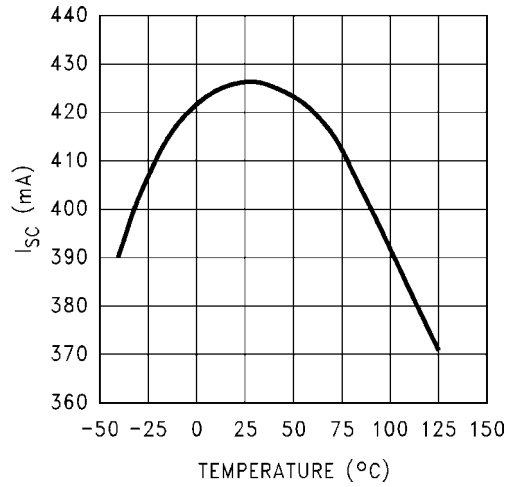

1250625

Short Circuit Current

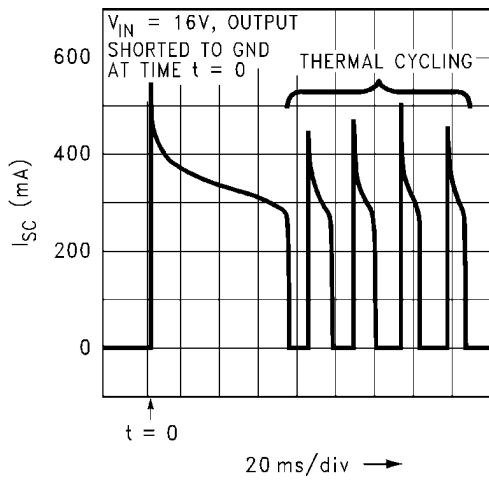

1250626

Instantaneous Short Circuit Current vs Output Voltage

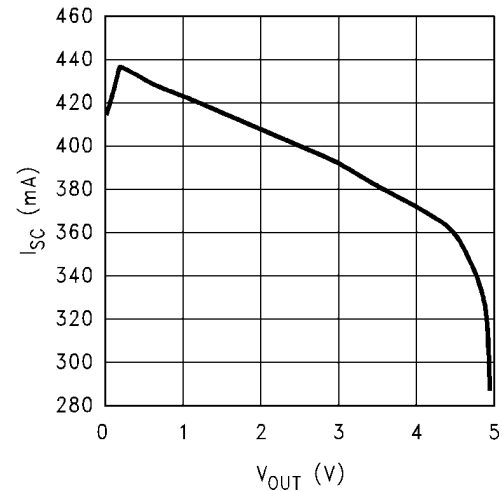

1250627

Output Impedance vs Frequency

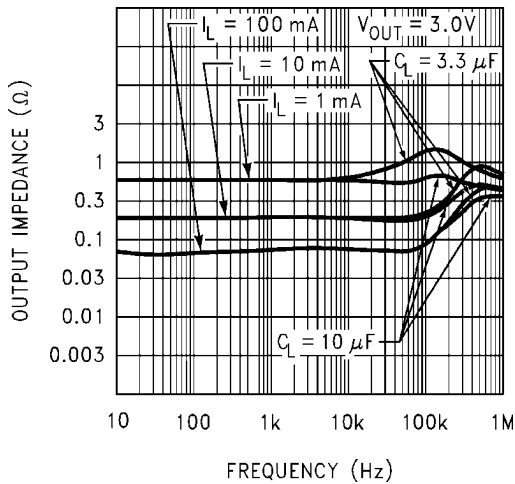

1250628

Ripple Rejection

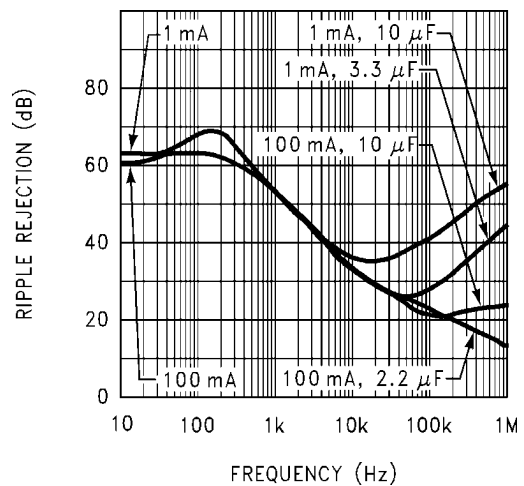

1250629

Output Noise Density

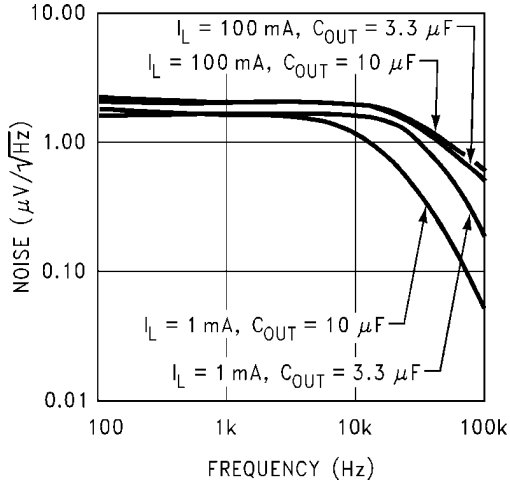

1250630

Output Impedance vs Frequency

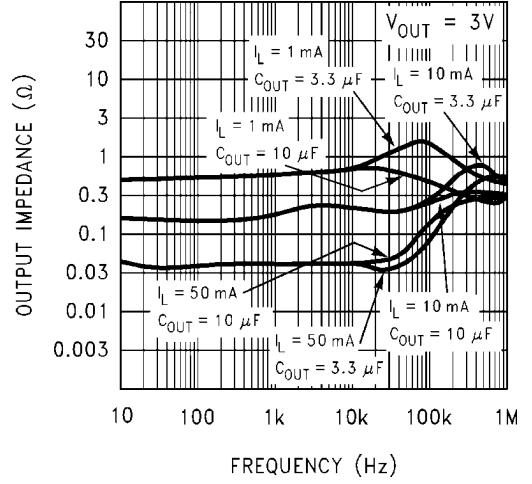

1250631

Input to Output Leakage vs Temperature

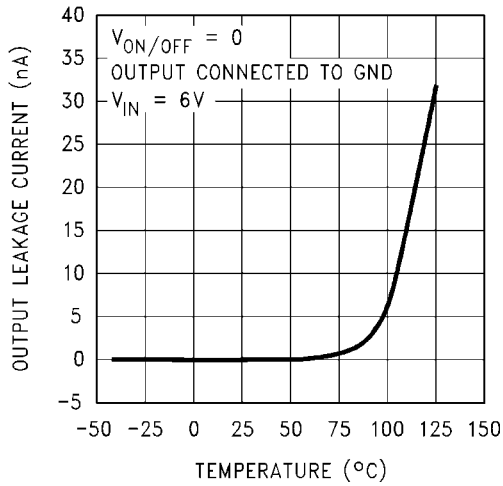

1250632

Output Reverse Leakage vs Temperature

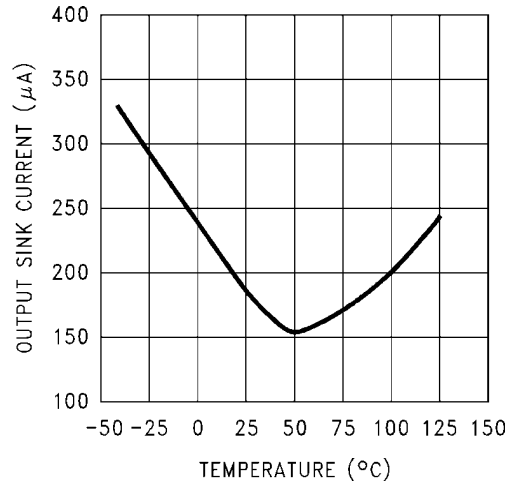

1250633

Turn-On Waveform

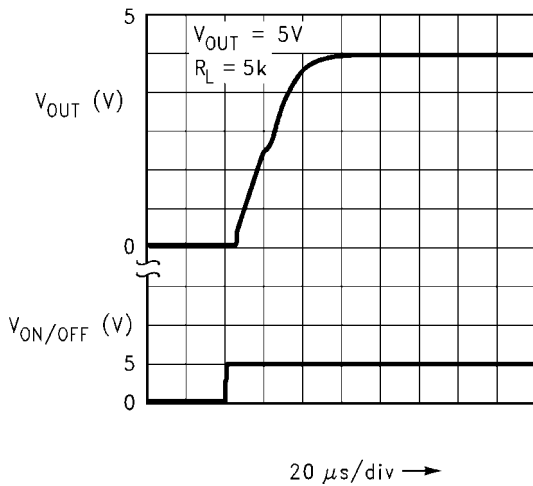

1250634

Turn-Off Waveform

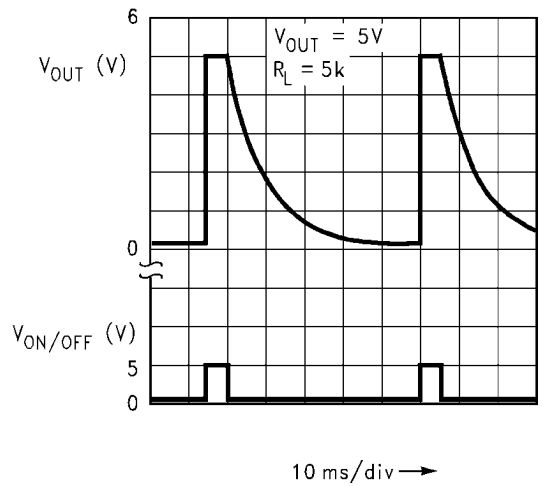

1250635

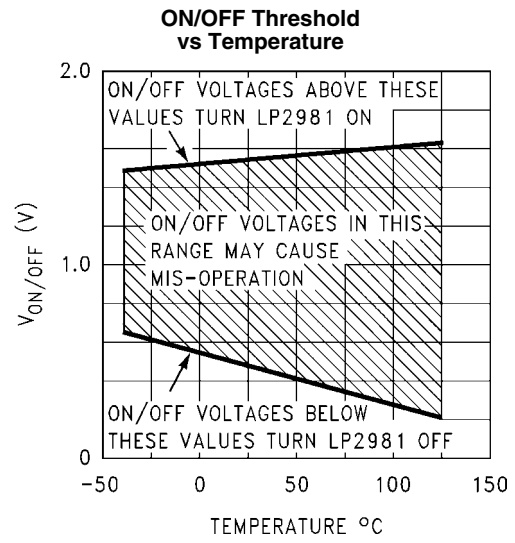
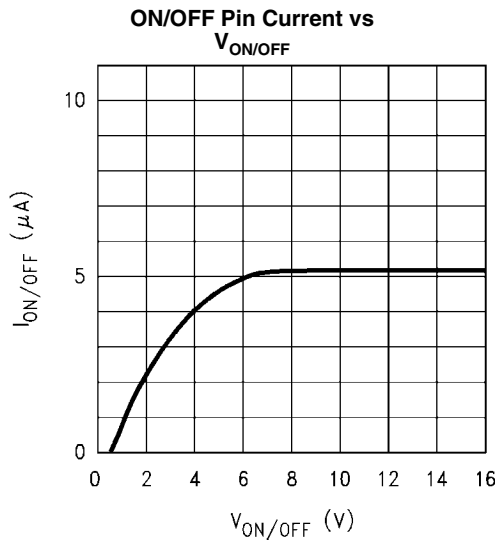

Application Hints

EXTERNAL CAPACITORS

Like any low-dropout regulator, the external capacitors used with the LP2981 must be carefully selected to assure regulator loop stability.

Input Capacitor: An input capacitor whose value is $\geq 1 \mu\text{F}$ is required with the LP2981 (amount of capacitance can be increased without limit).

This capacitor must be located a distance of not more than 0.5 from the input pin of the LP2981 and returned to a clean analog ground. Any good quality ceramic or tantalum can be used for this capacitor.

Output Capacitor: The output capacitor must meet both the requirement for minimum amount of capacitance and E.S.R. (equivalent series resistance) value. Curves are provided which show the allowable ESR range as a function of load current for various output voltages and capacitor values (refer to *Figures 1, 2, 3, 4*).

Important: The output capacitor must maintain its ESR in the stable region over the full operating temperature range to assure stability. Also, capacitor tolerance and variation with temperature must be considered to assure the minimum amount of capacitance is provided at all times.

This capacitor should be located not more than 0.5 from the output pin of the LP2981 and returned to a clean analog ground.

CAPACITOR CHARACTERISTICS

Tantalum: Tantalum capacitors are the best choice for use with the LP2981. Most good quality tantalums can be used with the LP2981, but check the manufacturer's data sheet to be sure the ESR is in range.

It is important to remember that ESR increases at lower temperatures and a capacitor that is near the upper limit for stability at room temperature can cause instability when it gets cold.

In applications which must operate at very low temperatures, it may be necessary to parallel the output tantalum capacitor with a ceramic capacitor to prevent the ESR from going up too high (see next section for important information on ceramic capacitors).

Ceramic: Ceramic capacitors are not recommended for use at the output of the LP2981. This is because the ESR of a ceramic can be low enough to go below the minimum stable value for the LP2981. A $2.2 \mu\text{F}$ ceramic was measured and found to have an ESR of about $15 \text{ m}\Omega$, which is low enough to cause oscillations.

If a ceramic capacitor is used on the output, a 1Ω resistor should be placed in series with the capacitor.

Aluminum: Because of large physical size, aluminum electrolytics are not typically used with the LP2981. They must meet the same ESR requirements over the operating temperature range, more difficult because of their steep increase at cold temperature.

An aluminum electrolytic can exhibit an ESR increase of as much as 50X when going from 20°C to -40°C . Also, some aluminum electrolytics are not operational below -25°C because the electrolyte can freeze.

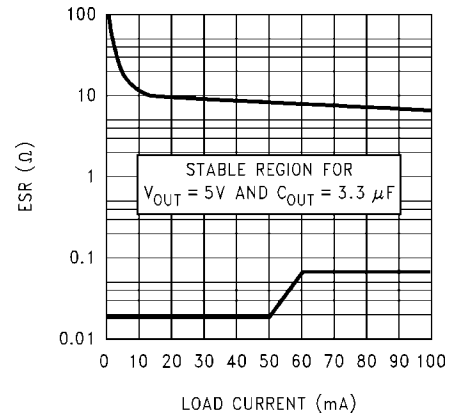

1250638

FIGURE 1. 5V/3.3 μF ESR Curves

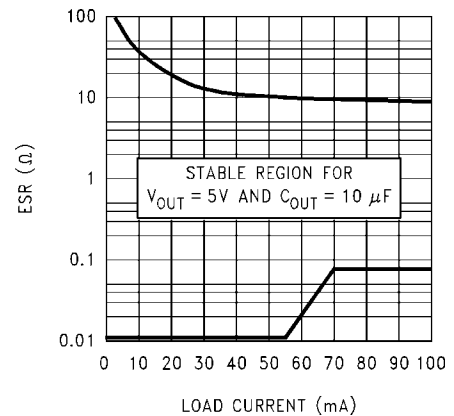

1250639

FIGURE 2. 5V/10 μF ESR Curves

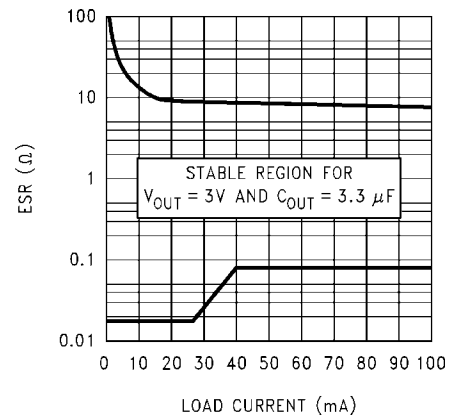

1250640

FIGURE 3. 3V/3.3 μF ESR Curves

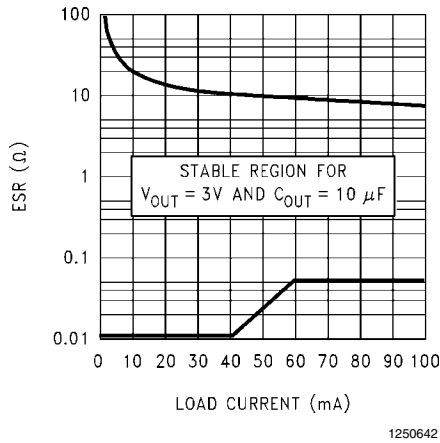

FIGURE 4. 3V/10 μF ESR Curves

REVERSE CURRENT PATH

The internal PNP power transistor used as the pass element in the LP2981 has an inherent diode connected between the regulator output and input. During normal operation (where the input voltage is higher than the output) this diode is reverse biased (See Figure 5).

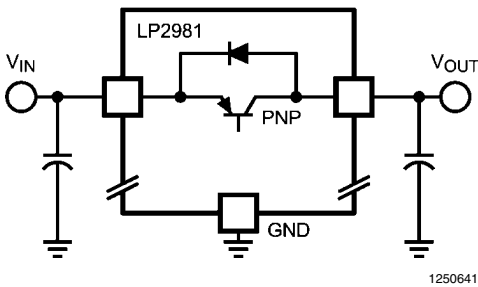

FIGURE 5. LP2981 Reverse Current Path

However, if the input voltage is more than a V_{BE} below the output voltage, this diode will turn ON and current will flow into the regulator output. In such cases, a parasitic SCR can latch which will allow a high current to flow into the V_{IN} pin and out the ground pin, which can damage the part.

The internal diode can also be turned on if the input voltage is abruptly stepped down to a voltage which is a V_{BE} below the output voltage.

In any application where the output voltage may be higher than the input voltage, an external Schottky diode must be connected from V_{IN} to V_{OUT} (cathode on V_{IN} , anode on V_{OUT}). See Figure 6), to limit the reverse voltage across the LP2981 to 0.3V (see *Absolute Maximum Ratings*)

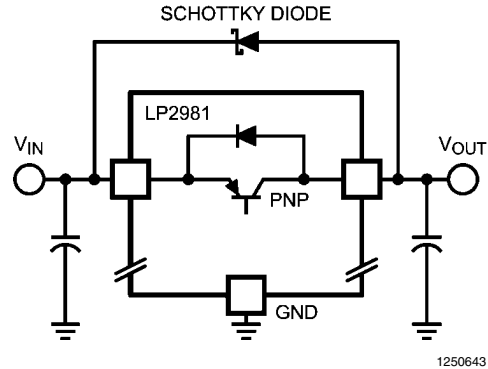

FIGURE 6. Adding External Schottky Diode Protection

ON/OFF INPUT OPERATION

The LP2981 is shut off by pulling the ON/OFF input low, and turned on by driving the input high. If this feature is not to be used, the ON/OFF input should be tied to V_{IN} to keep the regulator on at all times (the ON/OFF input must **not** be left floating).

To ensure proper operation, the signal source used to drive the ON/OFF input must be able to swing above and below the specified turn-on/turn-off voltage thresholds which guarantee an ON or OFF state (see Electrical Characteristics).

The ON/OFF signal may come from either a totem-pole output, or an open-collector output with pull-up resistor to the LP2981 input voltage or another logic supply. The high-level voltage may exceed the LP2981 input voltage, but must remain within the Absolute Maximum Ratings for the ON/OFF pin.

It is also important that the turn-on/turn-off voltage signals applied to the ON/OFF input have a slew rate which is greater than 40 mV/ μs .

IMPORTANT: The regulator shutdown function will not operate correctly if a slow-moving signal is applied to the ON/OFF input.

Physical Dimensions inches (millimeters) unless otherwise noted

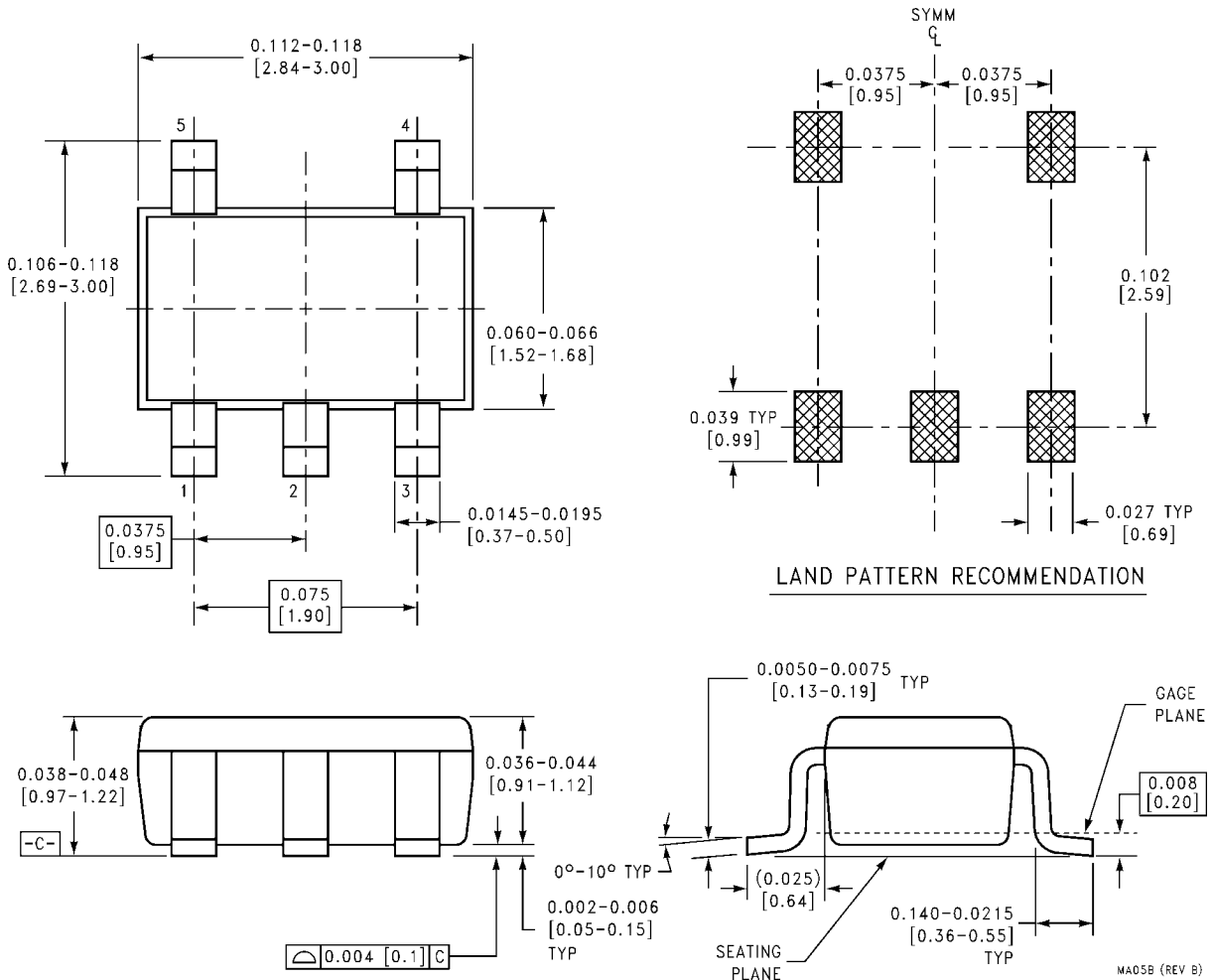

**5-Lead Small Outline Package (SOT-23)
NS Package Number MF05A**

For Order Numbers, refer to Table 1 in the "Ordering Information" section of this document.

MA05B (REV B)

Notes

LP2981

Notes

For more National Semiconductor product information and proven design tools, visit the following Web sites at:

Products		Design Support	
Amplifiers	www.national.com/amplifiers	WEBENCH® Tools	www.national.com/webench
Audio	www.national.com/audio	App Notes	www.national.com/appnotes
Clock and Timing	www.national.com/timing	Reference Designs	www.national.com/refdesigns
Data Converters	www.national.com/adc	Samples	www.national.com/samples
Interface	www.national.com/interface	Eval Boards	www.national.com/evalboards
LVDS	www.national.com/lvds	Packaging	www.national.com/packaging
Power Management	www.national.com/power	Green Compliance	www.national.com/quality/green
Switching Regulators	www.national.com/switchers	Distributors	www.national.com/contacts
LDOs	www.national.com/ldo	Quality and Reliability	www.national.com/quality
LED Lighting	www.national.com/led	Feedback/Support	www.national.com/feedback
Voltage Reference	www.national.com/vref	Design Made Easy	www.national.com/easy
PowerWise® Solutions	www.national.com/powerwise	Solutions	www.national.com/solutions
Serial Digital Interface (SDI)	www.national.com/sdi	Mil/Aero	www.national.com/milaero
Temperature Sensors	www.national.com/tempsensors	Solar Magic®	www.national.com/solarmagic
Wireless (PLL/VCO)	www.national.com/wireless	Analog University®	www.national.com/AU

THE CONTENTS OF THIS DOCUMENT ARE PROVIDED IN CONNECTION WITH NATIONAL SEMICONDUCTOR CORPORATION ("NATIONAL") PRODUCTS. NATIONAL MAKES NO REPRESENTATIONS OR WARRANTIES WITH RESPECT TO THE ACCURACY OR COMPLETENESS OF THE CONTENTS OF THIS PUBLICATION AND RESERVES THE RIGHT TO MAKE CHANGES TO SPECIFICATIONS AND PRODUCT DESCRIPTIONS AT ANY TIME WITHOUT NOTICE. NO LICENSE, WHETHER EXPRESS, IMPLIED, ARISING BY ESTOPPEL OR OTHERWISE, TO ANY INTELLECTUAL PROPERTY RIGHTS IS GRANTED BY THIS DOCUMENT.

TESTING AND OTHER QUALITY CONTROLS ARE USED TO THE EXTENT NATIONAL DEEMS NECESSARY TO SUPPORT NATIONAL'S PRODUCT WARRANTY. EXCEPT WHERE MANDATED BY GOVERNMENT REQUIREMENTS, TESTING OF ALL PARAMETERS OF EACH PRODUCT IS NOT NECESSARILY PERFORMED. NATIONAL ASSUMES NO LIABILITY FOR APPLICATIONS ASSISTANCE OR BUYER PRODUCT DESIGN. BUYERS ARE RESPONSIBLE FOR THEIR PRODUCTS AND APPLICATIONS USING NATIONAL COMPONENTS. PRIOR TO USING OR DISTRIBUTING ANY PRODUCTS THAT INCLUDE NATIONAL COMPONENTS, BUYERS SHOULD PROVIDE ADEQUATE DESIGN, TESTING AND OPERATING SAFEGUARDS.

EXCEPT AS PROVIDED IN NATIONAL'S TERMS AND CONDITIONS OF SALE FOR SUCH PRODUCTS, NATIONAL ASSUMES NO LIABILITY WHATSOEVER, AND NATIONAL DISCLAIMS ANY EXPRESS OR IMPLIED WARRANTY RELATING TO THE SALE AND/OR USE OF NATIONAL PRODUCTS INCLUDING LIABILITY OR WARRANTIES RELATING TO FITNESS FOR A PARTICULAR PURPOSE, MERCHANTABILITY, OR INFRINGEMENT OF ANY PATENT, COPYRIGHT OR OTHER INTELLECTUAL PROPERTY RIGHT.

LIFE SUPPORT POLICY

NATIONAL'S PRODUCTS ARE NOT AUTHORIZED FOR USE AS CRITICAL COMPONENTS IN LIFE SUPPORT DEVICES OR SYSTEMS WITHOUT THE EXPRESS PRIOR WRITTEN APPROVAL OF THE CHIEF EXECUTIVE OFFICER AND GENERAL COUNSEL OF NATIONAL SEMICONDUCTOR CORPORATION. As used herein:

Life support devices or systems are devices which (a) are intended for surgical implant into the body, or (b) support or sustain life and whose failure to perform when properly used in accordance with instructions for use provided in the labeling can be reasonably expected to result in a significant injury to the user. A critical component is any component in a life support device or system whose failure to perform can be reasonably expected to cause the failure of the life support device or system or to affect its safety or effectiveness.

National Semiconductor and the National Semiconductor logo are registered trademarks of National Semiconductor Corporation. All other brand or product names may be trademarks or registered trademarks of their respective holders.

Copyright© 2009 National Semiconductor Corporation

For the most current product information visit us at www.national.com



National Semiconductor Americas Technical Support Center
 Email: support@nsc.com
 Tel: 1-800-272-9959

National Semiconductor Europe Technical Support Center
 Email: europe.support@nsc.com
 German Tel: +49 (0) 180 5010 771
 English Tel: +44 (0) 870 850 4288

National Semiconductor Asia Pacific Technical Support Center
 Email: ap.support@nsc.com

National Semiconductor Japan Technical Support Center
 Email: jpn.feedback@nsc.com