

National Semiconductor is now part of  
Texas Instruments.

Search <http://www.ti.com/> for the latest technical  
information and details on our current products and services.

# Ground-Referenced, Ultra Low Noise, Stereo Headphone Amplifier

## General Description

The LM48861 is a single supply, ground-referenced stereo headphone amplifier. Part of National's PowerWise® product family, the LM48861 consumes only 3mW of power, yet still provides great audio performance. The ground-referenced architecture eliminates the larger DC blocking capacitors required by traditional headphone amplifier's saving board space and reducing cost.

The LM48861 features common-mode sensing that corrects for any differences between the amplifier ground and the potential at the headphone return terminal, minimizing noise created by any ground mismatches.

The LM48861 delivers 22mW/channel into a 32Ω load with <1% THD+N with a 1.8V supply. Power supply requirements allow operation from 1.2V to 2.8V. High power supply rejection ratio (PSRR), 83dB at 217Hz, allows the device to operate in noisy environments without additional power supply conditioning. A low power shutdown mode reduces supply current consumption to 0.01μA.

Superior click and pop suppression eliminates audible transients on power-up/down and during shutdown. The LM48861 is available in an ultra-small 12-bump, 0.4mm pitch, micro SMD package (1.215mm x 1.615mm).

## Key Specifications

- Output Power/channel at  
 $V_{DD} = 1.5V$ , THD+N = 1%  
 $R_L = 16\Omega$  12mW (typ)  
 $R_L = 32\Omega$  13mW (typ)
- Output Power/channel at  
 $V_{DD} = 1.8V$ , THD+N = 1%  
 $R_L = 16\Omega$  24mW (typ)  
 $R_L = 32\Omega$  22mW (typ)
- Quiescent Power Supply Current  
 at 1.5V 2mA (typ)
- PSRR at 217Hz 83dB (typ)
- Shutdown Current 0.01μA (typ)

## Features

- Ground referenced outputs – eliminates output coupling capacitors
- Common-mode sensing
- Advanced click-and-pop suppression
- Low supply current
- Minimum external components
- Micro-power shutdown
- ESD protection of 8kV HBM contact
- Available in space-saving 12-bump microSMD package

## Applications

- Mobile Phones
- Portable electronic devices
- MP3 Players

## Typical Application

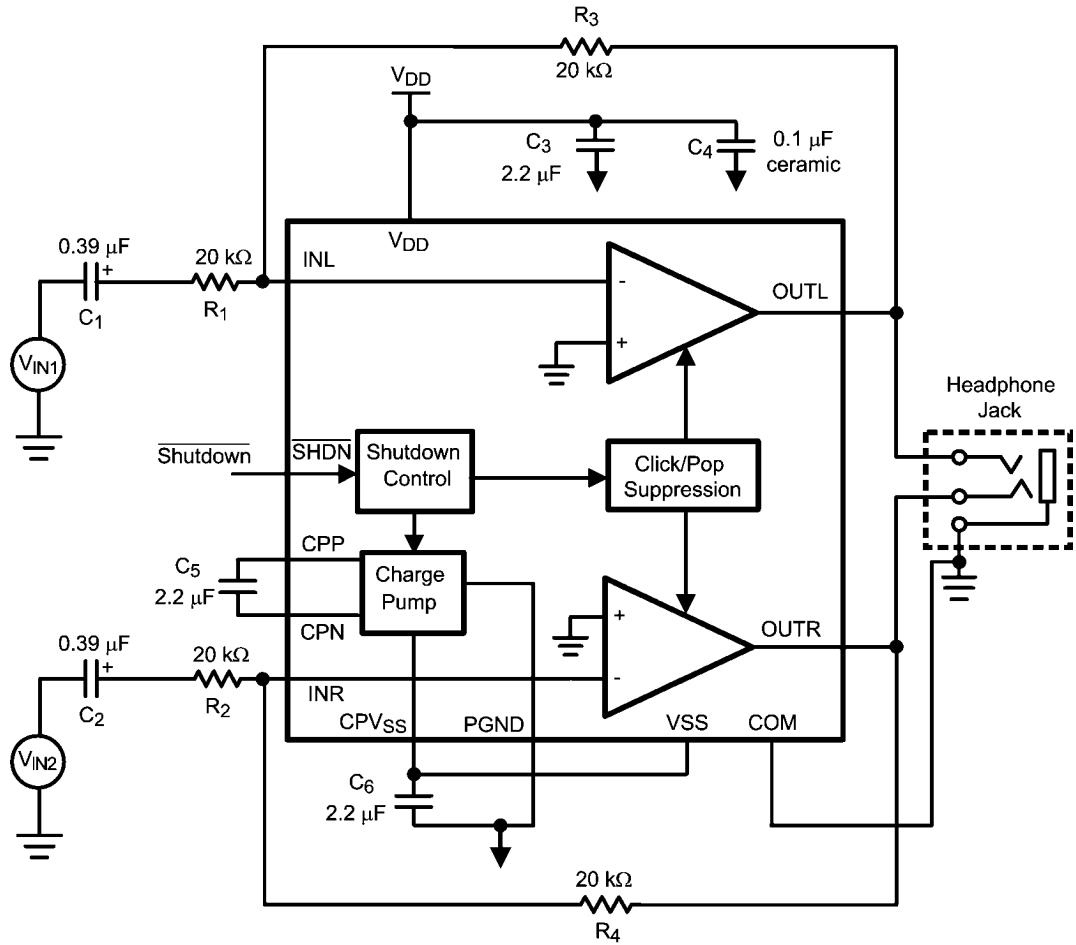

300541a9

FIGURE 1. Typical Audio Amplifier Application Circuit

## Connection Diagrams

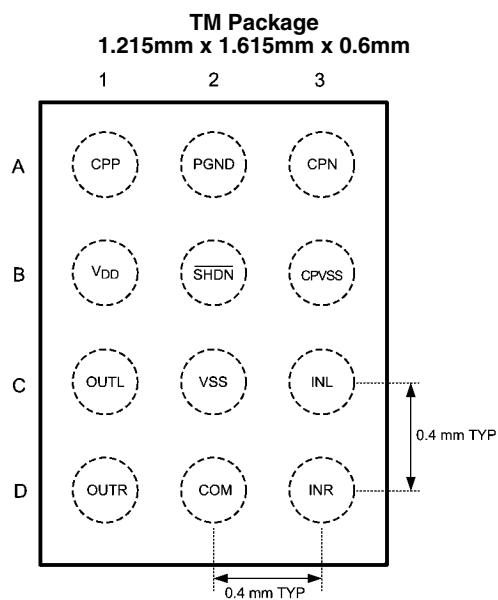

**Top View**  
Order Number LM48861TM  
See NS Package Number TMD12AAA

300541a8

**12 - Bump TM Marking**

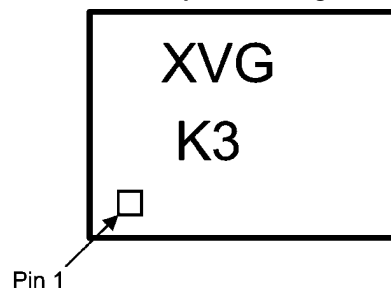

300541h5

**Top View**  
X = Date code  
V = Lot traceability  
G = Boomer  
K3 = LM48861TM

### Ordering Information

Order Number	Package	Package DWG #	Transport Media	MSL Level	Green Status
LM48861TM	12 Bump microSMD 0.4mm Pitch	TMD12AAA	250 and 3000 units on tape and reel	1	RoHS/no Sb/Br

### Bump Description

Bump	Name	Description
A1	CPP	Charge Pump Flying Capacitor Positive Terminal
A2	PGND	Power Ground
A3	CPN	Charge Pump Flying Capacitor Negative Terminal
B1	V <sub>DD</sub>	Positive Power Supply
B2	$\overline{\text{SHDN}}$	Active Low Shutdown
B3	CPV <sub>SS</sub>	Charge Pump Output
C1	OUTL	Left Channel Output
C2	V <sub>SS</sub>	Negative Power Supply
C3	INL	Left Channel Input
D1	OUTR	Right Channel Output
D2	COM	Ground reference for inputs and HP
D3	INR	Right Channel Input

## Absolute Maximum Ratings (Note 1, Note 2)

2)

If Military/Aerospace specified devices are required, please contact the National Semiconductor Sales Office/Distributors for availability and specifications.

Supply Voltage (Note 1)	3V
Storage Temperature	-65°C to +150°C
Input Voltage	-0.3V to $V_{DD} + 0.3V$
Power Dissipation (Note 3)	Internally Limited
ESD Ratings (HBM) (Note 4)	2000V
ESD Ratings (OUTL, OUTF) (Note 4)	8000V

ESD Susceptibility (Machine Model) (Note 5)	200V
Junction Temperature	150°C
Thermal Resistance $\theta_{JA}$ (TM)	70°C/W (typ)

## Operating Ratings

Temperature Range	$T_{MIN} \leq T_A \leq T_{MAX}$	-40°C $\leq T_A \leq$ +85°C
Supply Voltage ( $V_{DD}$ )		1.2V $\leq V_{DD} \leq$ 2.8V

## Electrical Characteristics $V_{DD} = 1.5V$ (Note 1, Note 2)

The following specifications apply for  $V_{DD} = 1.5V$ ,  $A_V = -1V/V$ ,  $R_L = 32k\Omega$ ,  $f = 1kHz$ , unless otherwise specified. Limits apply for  $T_A = 25^\circ C$ .

Symbol	Parameter	Conditions	LM48861		Units (Limits)
			Typical (Note 6)	Limit (Note 7)	
$I_{DD}$	Quiescent Power Supply Current	$V_{IN} = 0V$ , Both channels enabled	2	2.8	mA (max)
$I_{SD}$	Shutdown Current	Shutdown Enabled $V_{SHDN} = GND$	0.01	1.5	$\mu A$ (max)
$V_{OS}$	Output Offset Voltage	$V_{IN} = 0V$ , $R_L = 32\Omega$ Both channels enabled	0.5	1.5	mV (max)
$V_{IH}$	Shutdown Input Voltage High			1.4	V(min)
$V_{IL}$	Shutdown Input Voltage Low			0.4	V(max)
$T_{WU}$	Wake Up Time		500	700	$\mu s$ (max)
$P_O$	Output Power	THD+N = 1% $R_L = 32\Omega$ , $f = 1kHz$ , Both channels in phase and active $V_{DD} = 1.5V$ $V_{DD} = 1.8V$	13 22	12 20	mW (min) mW (min)
		THD+N = 1% $R_L = 16\Omega$ , $f = 1kHz$ , Both channels in phase and active $V_{DD} = 1.5V$ $V_{DD} = 1.8V$	12 24		mW mW
$V_{LINE-OUT}$	Output Voltage to Line Out	$R_L = 10k\Omega$ , $f = 1kHz$			
		$V_{DD} = 1.5V$ , THD+N = 1%, $R_L = 10k\Omega$	1.1	1	$V_{RMS}$ (min)
		$V_{DD} = 1.8V$ , THD+N = 1%, $R_L = 10k\Omega$	1.3	1.2	$V_{RMS}$ (min)
THD+N	Total Harmonic Distortion + Noise	$P_O = 8mW$ , $f = 1kHz$ , $R_L = 32\Omega$	0.04		%
		$P_O = 8mW$ , $f = 1kHz$ , $R_L = 16\Omega$	0.07		%
		$V_{OLIF} = 900mV_{RMS}$ , $f = 1kHz$ , $R_L = 10k\Omega$	0.001		%
PSRR	Power Supply Rejection Ratio	$V_{RIPPLE} = 200mV_{P-P}$ Sine, Inputs AC GND, $C1 = C2 = 0.39\mu F$			
		$f_{RIPPLE} = 217Hz$	83		dB
		$f_{RIPPLE} = 1kHz$	77		dB
	$f_{RIPPLE} = 15kHz$	57		dB	
SNR	Signal-to-Noise Ratio	$R_L = 32\Omega$ , $P_{OUT} = 8mW$ (A-weighted), $f = 1kHz$ $BW = 20Hz$ to $22kHz$	102		dB
$X_{TALK}$	Crosstalk	$R_L = 32\Omega$ , $P_{OUT} = 5mW$ , $f = 1kHz$	93		dB

Symbol	Parameter	Conditions	LM48861		Units (Limits)
			Typical (Note 6)	Limit (Note 7)	
N <sub>OUT</sub>	Output Noise	A-weighted, A <sub>V</sub> = 5.1dB R1 = R2 = 10kΩ, R3 = R4 = 18kΩ	5		μV
C-P	Click-Pop	Inputs Grounded BW = <10Hz to >500kHz	79		dB

**Note 1:** "Absolute Maximum Ratings" indicate limits beyond which damage to the device may occur, including inoperability and degradation of device reliability and/or performance. Functional operation of the device and/or non-degradation at the *Absolute Maximum Ratings* or other conditions beyond those indicated in the *Recommended Operating Conditions* is not implied. The *Recommended Operating Conditions* indicate conditions at which the device is functional and the device should not be operated beyond such conditions. All voltages are measured with respect to the ground pin, unless otherwise specified

**Note 2:** The *Electrical Characteristics* tables list guaranteed specifications under the listed *Recommended Operating Conditions* except as otherwise modified or specified by the *Electrical Characteristics Conditions* and/or Notes. Typical specifications are estimations only and are not guaranteed.

**Note 3:** Maximum allowable power dissipation is  $P_{DMAX} = (T_{JMAX} - T_A) / \theta_{JA}$  or the number given in *Absolute Maximum Ratings*, whichever is lower.

**Note 4:** Human body model, applicable std. JESD22-A114C.

**Note 5:** Machine model, applicable std. JESD22-A115-A.

**Note 6:** Typical values represent most likely parametric norms at  $T_A = +25^\circ\text{C}$ , and at the *Recommended Operation Conditions* at the time of product characterization and are not guaranteed.

**Note 7:** Datasheet min/max specification limits are guaranteed by test or statistical analysis.

# Typical Performance Characteristics

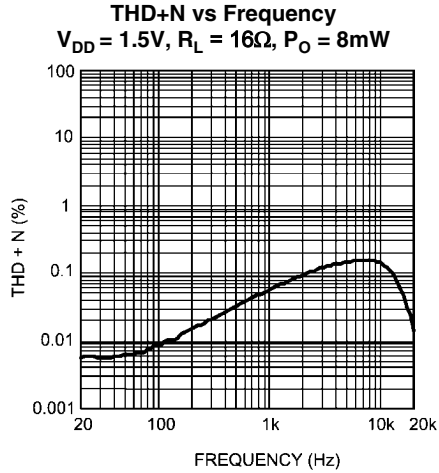

300541b2

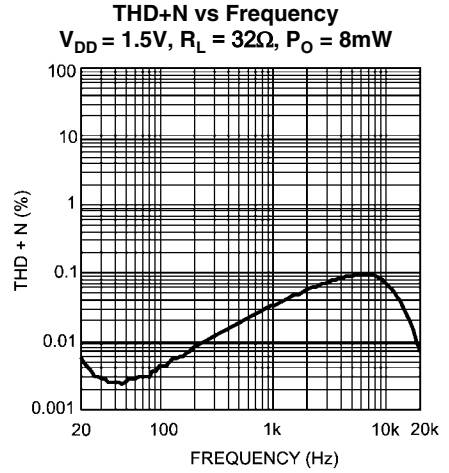

300541b3

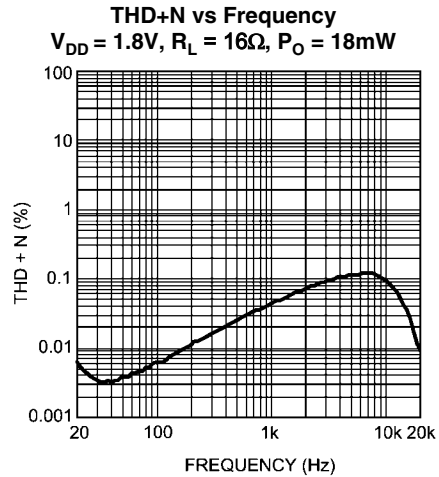

300541b4

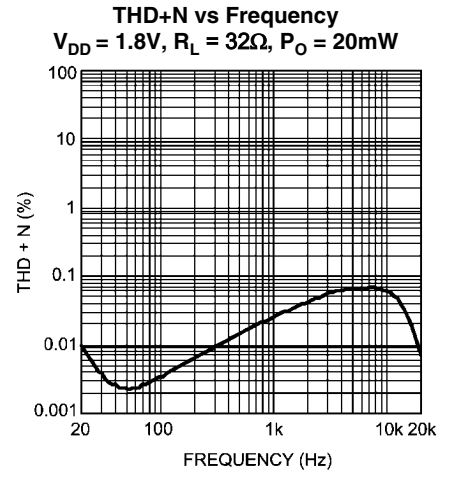

300541b5

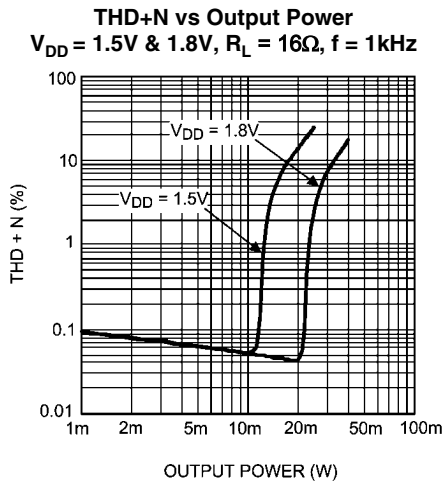

300541d1

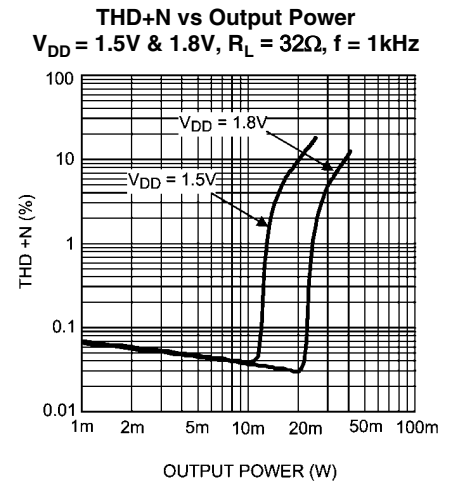

300541d2

**Power Dissipation vs Output Power**  
 $R_L = 16\Omega, f = 1\text{kHz}$

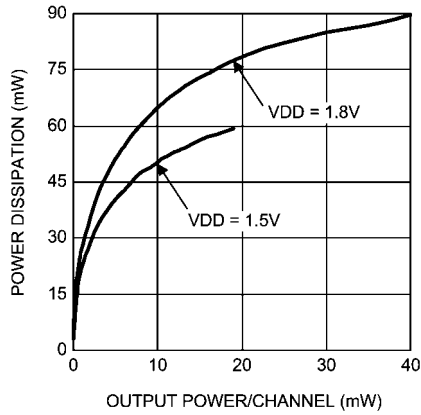

300541h2

**Power Dissipation vs Output Power**  
 $R_L = 32\Omega, f = 1\text{kHz}$

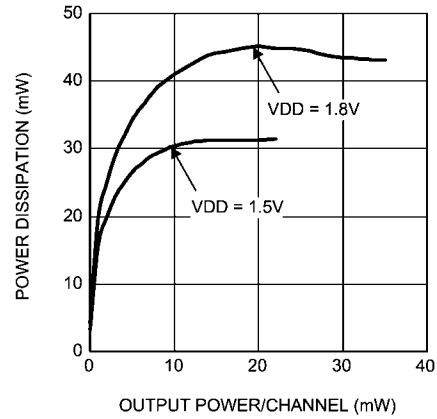

300541h3

**PSRR vs Frequency**  
 $V_{DD} = 1.5\text{V}, V_{RIPPLE} = 200\text{mV}_{p-p}, R_L = 32\Omega$

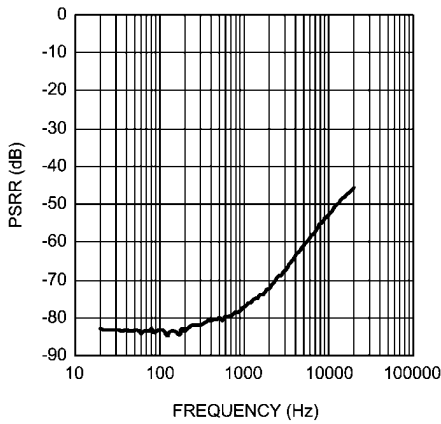

300541e8

**Output Power vs Supply Voltage**  
 $R_L = 16\Omega, f = 1\text{kHz}$

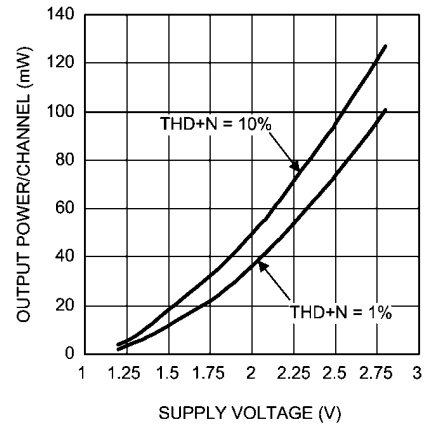

30054102

**Output Power vs Supply Voltage**  
 $R_L = 32\Omega, f = 1\text{kHz}$

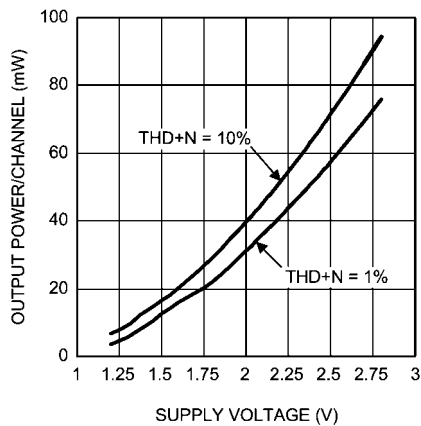

30054103

**Supply Current vs Supply Voltage**  
 No Load

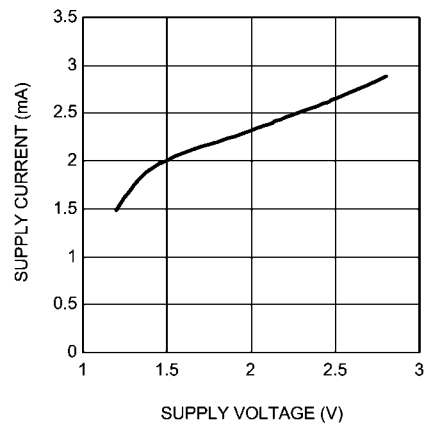

300541d0



Shutdown Current vs Supply Voltage  
No Load

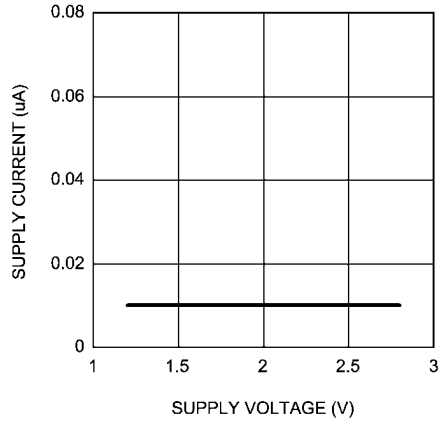

300541c9

Crosstalk vs Frequency  
 $V_{DD} = 1.5V, P_{OUT} = 5mW, R_L = 32\Omega$

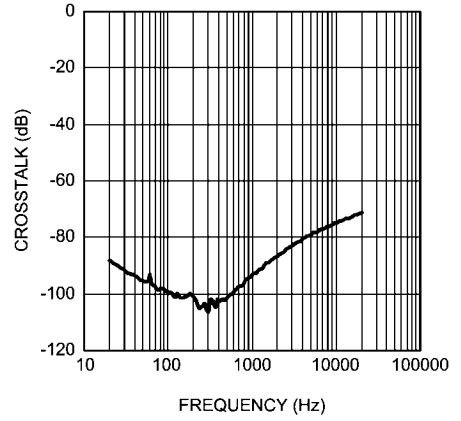

300541c7

## Application Information

### GENERAL AMPLIFIER FUNCTION

The LM48861 headphone amplifier features National's ground referenced architecture that eliminates the large DC-blocking capacitors required at the outputs of traditional headphone amplifiers. A low-noise inverting charge pump creates a negative supply (CPV<sub>SS</sub>) from the positive supply voltage (V<sub>DD</sub>). The headphone amplifiers operate from these bipolar supplies, with the amplifier outputs biased about GND, instead of a nominal DC voltage (typically V<sub>DD</sub>/2), like traditional amplifiers. Because there is no DC component to the headphone output signals, the large DC-blocking capacitors (typically 220μF) are not necessary, conserving board space and system cost, while improving frequency response.

### COMMON MODE SENSE

The LM48861 features a ground (common mode) sensing feature. In noisy applications, or where the headphone jack is used as a line out to other devices, noise pick up and ground imbalance can degrade audio quality. The LM48861 COM input senses and corrects any noise at the headphone return, or any ground imbalance between the headphone return and device ground, improving audio reproduction. Connect COM directly to the headphone return terminal of the headphone jack (Figure 2). No additional external components are required. Connect COM to GND if the common-mode sense feature is not in use.

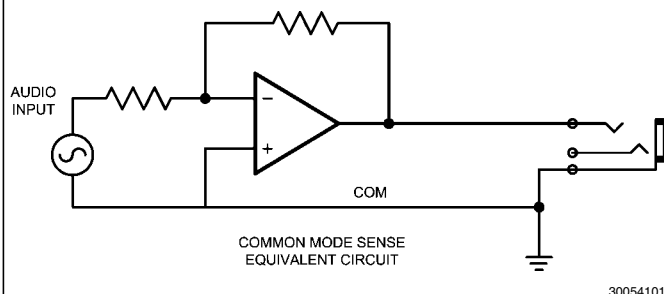

FIGURE 2.

### MICRO POWER SHUTDOWN

The voltage applied to the shutdown ( $\overline{\text{SHDN}}$ ) pin controls the LM48861's shutdown function. Activate micro-power shutdown by applying a logic-low voltage to the  $\overline{\text{SHDN}}$  pin. When active, the LM48861's micro-power shutdown feature turns off the amplifier's bias circuitry, reducing the supply current. The trigger point is 0.4V (max) for a logic-low level, and 1.4V (min) for a logic-high level. The low 0.1μA (typ) shutdown current is achieved by applying a voltage that is as near as ground as possible to the  $\overline{\text{SHDN}}$  pin. A voltage that is higher than ground may increase the shutdown current.

There are a few ways to control the micro-power shutdown. These include using a single-pole, single-throw switch, a microprocessor, or a microcontroller. When using a switch, connect an external 100kΩ pull-up resistor between the  $\overline{\text{SHDN}}$  pin and GND. Connect the switch between the  $\overline{\text{SHDN}}$  pin and V<sub>DD</sub>. Select normal amplifier operation by closing the switch. Opening the switch connects the  $\overline{\text{SHDN}}$  pin to ground, activating micro-power shutdown. The switch and resistor guarantee that the  $\overline{\text{SHDN}}$  pin will not float. This prevents unwanted state changes. In a system with a microprocessor or microcontroller, use a digital output to apply the control

voltage to the  $\overline{\text{SHDN}}$  pin. Driving the  $\overline{\text{SHDN}}$  pin with active circuitry eliminates the pull-up resistor.

### POWER DISSIPATION

Power dissipation is a major concern when using any power amplifier, especially one in mobile devices. In the LM48861, the power dissipation comes from the charge pump and two operational amplifiers. Refer to the Power Dissipation vs Output Power curve in the Typical Performance Characteristics section of the datasheet to find the power dissipation associated the output power level of the LM48861. The power dissipation should not exceed the maximum power dissipation point of the micro SMD package given in equation 1.

$$P_{\text{DMAX}} = (T_{\text{JMAX}} - T_{\text{A}}) / (\theta_{\text{JA}}) \quad (1)$$

For the LM48861TM micro SMD package,  $\theta_{\text{JA}} = 70^{\circ}\text{C}/\text{W}$ ,  $T_{\text{JMAX}} = 150^{\circ}\text{C}$ , and  $T_{\text{A}}$  is the ambient temperature of the system surroundings.

### PROPER SELECTION OF EXTERNAL COMPONENTS

#### Power Supply Bypassing/Filtering

Proper power supply bypassing is critical for low noise performance and high PSRR. Place the supply bypass capacitors as close to the supply pins as possible. Place a 1μF ceramic capacitor from V<sub>DD</sub> to GND. Additional bulk capacitance may be added as required.

#### Charge Pump Capacitor Selection

Use low ESR ceramic capacitors (less than 100mΩ) for optimum performance.

#### Charge Pump Flying Capacitor (C5)

The flying capacitor (C5) affects the load regulation and output impedance of the charge pump. A C5 value that is too low results in a loss of current drive, leading to a loss of amplifier headroom. A higher valued C5 improves load regulation and lowers charge pump output impedance to an extent. Above 2.2μF, the R<sub>DS(ON)</sub> of the charge pump switches and the ESR of C5 and C6 dominate the output impedance. A lower value capacitor can be used in systems with low maximum output power requirements.

#### Charge Pump Hold Capacitor (C6)

The value and ESR of the hold capacitor (C6) directly affects the ripple on CPV<sub>SS</sub>. Increasing the value of C6 reduces output ripple. Decreasing the ESR of C6 reduces both output ripple and charge pump output impedance. A lower value capacitor can be used in systems with low maximum output power requirements.

#### Power Supply Bypassing /Filtering

Proper power supply bypassing is critical for low noise performance and high PSRR. Place the supply bypass capacitors as close to the device as possible. Typical applications employ a voltage regulator with 10μF and 0.1μF bypass capacitors that increase supply stability. These capacitors do not eliminate the need for bypassing of the LM48861 supply pins. A 1μF capacitor is recommended.

#### Input Capacitor Selection

The LM48861 requires input coupling capacitors. Input capacitors block the DC component of the audio signal, eliminating any conflict between the DC component of the audio source and the bias voltage of the LM48861. The input capacitors create a high-pass filter with the input resistors R<sub>IN</sub>.

The -3dB point of the high-pass filter is found using Equation (2) below.

$$f = 1 / 2\pi R_{IN} C_{IN} \quad (2)$$

Where the value of  $R_{IN}$  is selected based on the gain-setting resistor selection. In relation to Figure 1,  $R_{IN} = R1 = R2$ ,  $C_{IN} = C1 = C2$ .

The input capacitors can also be used to remove low frequency content from the audio signal. Small speakers can not reproduce, and may even be damaged by low frequencies. High-pass filtering the audio signal helps protect the speakers. When the LM48861 is using a single-ended source, power supply noise on the ground is seen as an input signal. Setting the high-pass filter point above the power supply noise frequencies, 217Hz in a GSM phone, for example, filters out the noise such that it is not amplified and heard on the output. Capacitors with a tolerance of 10% or better are recommended for impedance matching and improved CMRR and PSRR.

## PCB Layout Guidelines

Minimize trace impedance of the power, ground and all output traces for optimum performance. Voltage loss due to trace resistance between the LM48861 and the load results in decreased output power and efficiency. Trace resistance between the power supply and ground has the same effect as a poorly regulated supply, increased ripple and reduced peak output power. Use wide traces for power supply inputs and amplifier outputs to minimize losses due to trace resistance, as well as route heat away from the device. Proper grounding improves audio performance, minimizes crosstalk between channels and prevents switching noise from interfering with the audio signal. Use of power and ground planes is recommended.

As described in the Common Mode Sense section, the LM48861 features a ground sensing feature. On the PCB layout, connect the COM pin (pin D2) directly to the headphone jack ground and also to the left and right input grounds. This will help correct any noise or any ground imbalance between the headphone return, input, and the device ground, therefore improving audio reproduction.

The charge pump capacitors and traces connecting the capacitor to the device should be kept away from the input and output traces to avoid any switching noise injected into the input or output.

# Demo Board Schematic and Layout

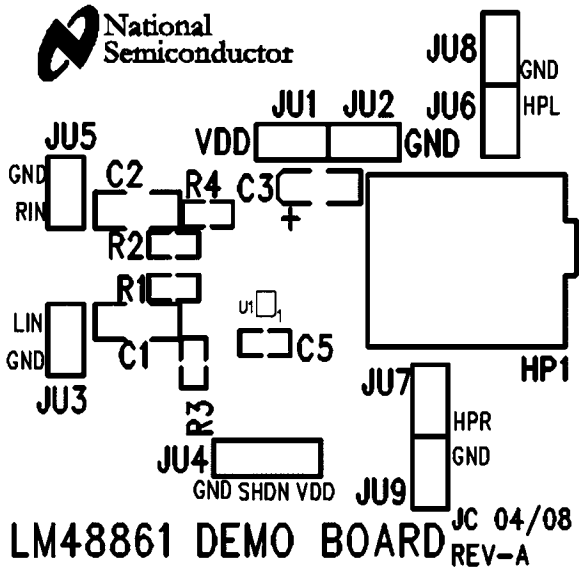

FIGURE 3: Top Silkscreen Layer

30054110

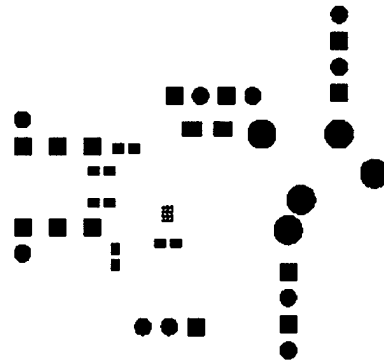

FIGURE 4: Top Solder Mask

30054199

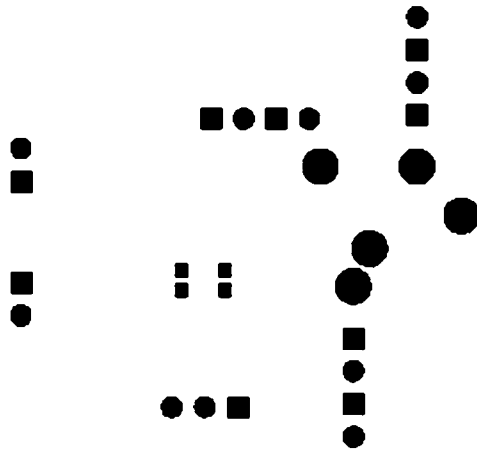

FIGURE 5: Bottom Solder Mask

30054106

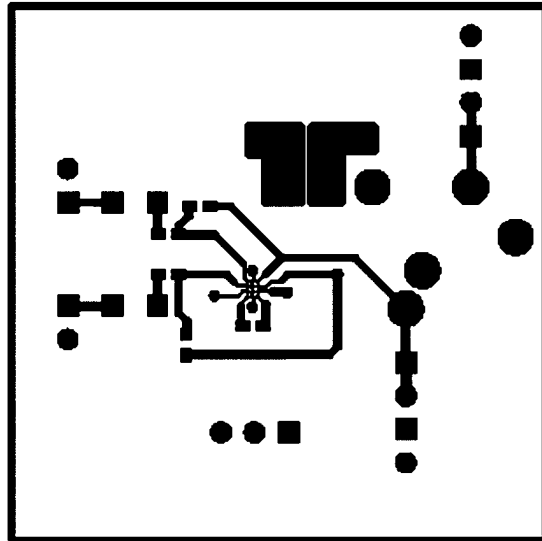

FIGURE 6: Top Layer

30054109

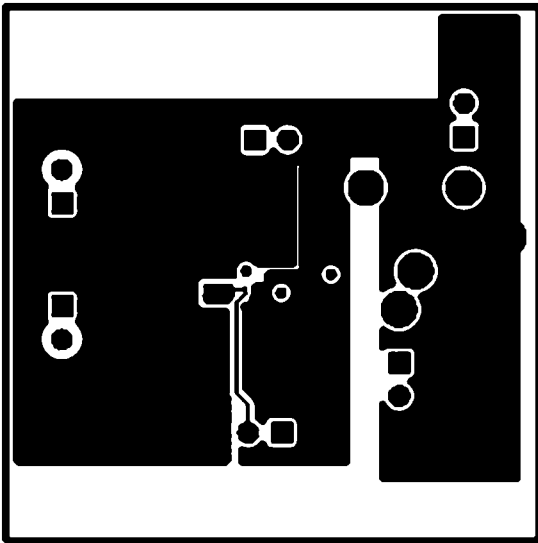

FIGURE 7: Layer 2

30054107

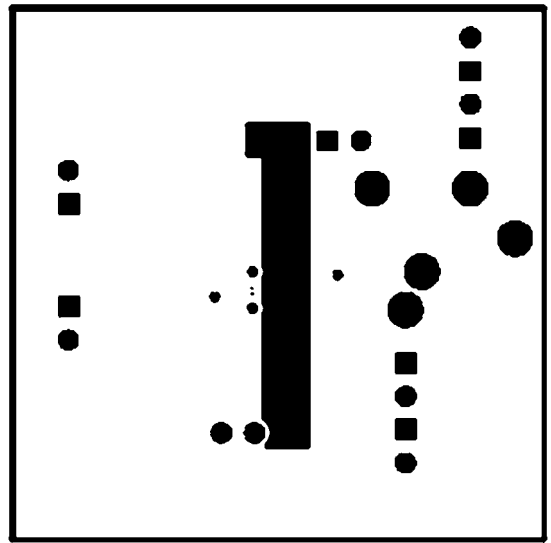

FIGURE 8: Layer 3

30054108

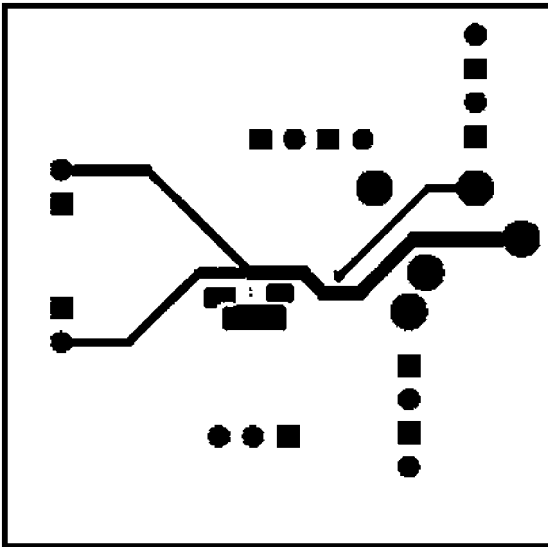

FIGURE 9: Bottom Layer

30054104



22180087-001 REV-B

FIGURE 10: Bottom Silkscreen

30054105

## Revision History

<b>Rev</b>	<b>Date</b>	<b>Description</b>
1.0	06/11/08	Initial release.
1.01	02/08/10	Input text edits.

**Physical Dimensions** inches (millimeters) unless otherwise noted

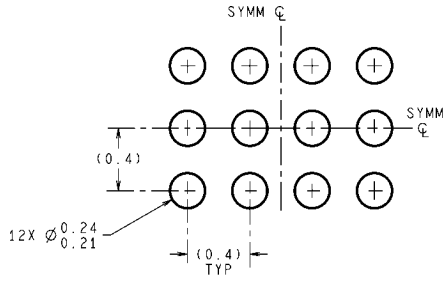

**DIMENSIONS ARE IN MILLIMETERS**  
DIMENSIONS IN ( ) FOR REFERENCE ONLY

**LAND PATTERN RECOMMENDATION**

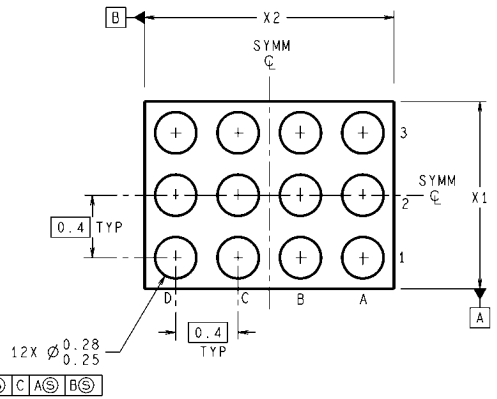
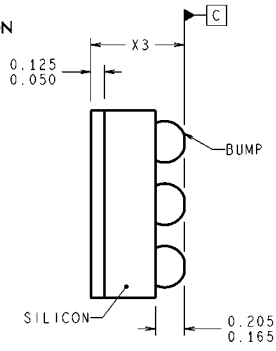
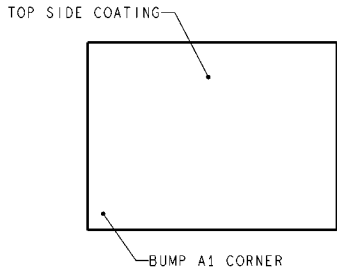

$\oplus 0.005 \text{ C A B S}$

TMD12XXX (Rev A)

**TM Package**  
**Order Number LM48861TM**  
**NS Package Number TMD12AAA**  
**X1 = 1.215mm, X2 = 1.615mm, X3 = 0.6mm**

# Notes

LM48861



## Notes

For more National Semiconductor product information and proven design tools, visit the following Web sites at:  
[www.national.com](http://www.national.com)

Products		Design Support	
Amplifiers	<a href="http://www.national.com/amplifiers">www.national.com/amplifiers</a>	WEBENCH® Tools	<a href="http://www.national.com/webench">www.national.com/webench</a>
Audio	<a href="http://www.national.com/audio">www.national.com/audio</a>	App Notes	<a href="http://www.national.com/appnotes">www.national.com/appnotes</a>
Clock and Timing	<a href="http://www.national.com/timing">www.national.com/timing</a>	Reference Designs	<a href="http://www.national.com/refdesigns">www.national.com/refdesigns</a>
Data Converters	<a href="http://www.national.com/adc">www.national.com/adc</a>	Samples	<a href="http://www.national.com/samples">www.national.com/samples</a>
Interface	<a href="http://www.national.com/interface">www.national.com/interface</a>	Eval Boards	<a href="http://www.national.com/evalboards">www.national.com/evalboards</a>
LVDS	<a href="http://www.national.com/lvds">www.national.com/lvds</a>	Packaging	<a href="http://www.national.com/packaging">www.national.com/packaging</a>
Power Management	<a href="http://www.national.com/power">www.national.com/power</a>	Green Compliance	<a href="http://www.national.com/quality/green">www.national.com/quality/green</a>
Switching Regulators	<a href="http://www.national.com/switchers">www.national.com/switchers</a>	Distributors	<a href="http://www.national.com/contacts">www.national.com/contacts</a>
LDOs	<a href="http://www.national.com/ldo">www.national.com/ldo</a>	Quality and Reliability	<a href="http://www.national.com/quality">www.national.com/quality</a>
LED Lighting	<a href="http://www.national.com/led">www.national.com/led</a>	Feedback/Support	<a href="http://www.national.com/feedback">www.national.com/feedback</a>
Voltage References	<a href="http://www.national.com/vref">www.national.com/vref</a>	Design Made Easy	<a href="http://www.national.com/easy">www.national.com/easy</a>
PowerWise® Solutions	<a href="http://www.national.com/powerwise">www.national.com/powerwise</a>	Applications & Markets	<a href="http://www.national.com/solutions">www.national.com/solutions</a>
Serial Digital Interface (SDI)	<a href="http://www.national.com/sdi">www.national.com/sdi</a>	Mil/Aero	<a href="http://www.national.com/milaero">www.national.com/milaero</a>
Temperature Sensors	<a href="http://www.national.com/tempensors">www.national.com/tempensors</a>	SolarMagic™	<a href="http://www.national.com/solarmagic">www.national.com/solarmagic</a>
PLL/VCO	<a href="http://www.national.com/wireless">www.national.com/wireless</a>	PowerWise® Design University	<a href="http://www.national.com/training">www.national.com/training</a>

THE CONTENTS OF THIS DOCUMENT ARE PROVIDED IN CONNECTION WITH NATIONAL SEMICONDUCTOR CORPORATION ("NATIONAL") PRODUCTS. NATIONAL MAKES NO REPRESENTATIONS OR WARRANTIES WITH RESPECT TO THE ACCURACY OR COMPLETENESS OF THE CONTENTS OF THIS PUBLICATION AND RESERVES THE RIGHT TO MAKE CHANGES TO SPECIFICATIONS AND PRODUCT DESCRIPTIONS AT ANY TIME WITHOUT NOTICE. NO LICENSE, WHETHER EXPRESS, IMPLIED, ARISING BY ESTOPPEL OR OTHERWISE, TO ANY INTELLECTUAL PROPERTY RIGHTS IS GRANTED BY THIS DOCUMENT.

TESTING AND OTHER QUALITY CONTROLS ARE USED TO THE EXTENT NATIONAL DEEMS NECESSARY TO SUPPORT NATIONAL'S PRODUCT WARRANTY. EXCEPT WHERE MANDATED BY GOVERNMENT REQUIREMENTS, TESTING OF ALL PARAMETERS OF EACH PRODUCT IS NOT NECESSARILY PERFORMED. NATIONAL ASSUMES NO LIABILITY FOR APPLICATIONS ASSISTANCE OR BUYER PRODUCT DESIGN. BUYERS ARE RESPONSIBLE FOR THEIR PRODUCTS AND APPLICATIONS USING NATIONAL COMPONENTS. PRIOR TO USING OR DISTRIBUTING ANY PRODUCTS THAT INCLUDE NATIONAL COMPONENTS, BUYERS SHOULD PROVIDE ADEQUATE DESIGN, TESTING AND OPERATING SAFEGUARDS.

EXCEPT AS PROVIDED IN NATIONAL'S TERMS AND CONDITIONS OF SALE FOR SUCH PRODUCTS, NATIONAL ASSUMES NO LIABILITY WHATSOEVER, AND NATIONAL DISCLAIMS ANY EXPRESS OR IMPLIED WARRANTY RELATING TO THE SALE AND/OR USE OF NATIONAL PRODUCTS INCLUDING LIABILITY OR WARRANTIES RELATING TO FITNESS FOR A PARTICULAR PURPOSE, MERCHANTABILITY, OR INFRINGEMENT OF ANY PATENT, COPYRIGHT OR OTHER INTELLECTUAL PROPERTY RIGHT.

#### LIFE SUPPORT POLICY

**NATIONAL'S PRODUCTS ARE NOT AUTHORIZED FOR USE AS CRITICAL COMPONENTS IN LIFE SUPPORT DEVICES OR SYSTEMS WITHOUT THE EXPRESS PRIOR WRITTEN APPROVAL OF THE CHIEF EXECUTIVE OFFICER AND GENERAL COUNSEL OF NATIONAL SEMICONDUCTOR CORPORATION.** As used herein:

Life support devices or systems are devices which (a) are intended for surgical implant into the body, or (b) support or sustain life and whose failure to perform when properly used in accordance with instructions for use provided in the labeling can be reasonably expected to result in a significant injury to the user. A critical component is any component in a life support device or system whose failure to perform can be reasonably expected to cause the failure of the life support device or system or to affect its safety or effectiveness.

National Semiconductor and the National Semiconductor logo are registered trademarks of National Semiconductor Corporation. All other brand or product names may be trademarks or registered trademarks of their respective holders.

Copyright© 2010 National Semiconductor Corporation

For the most current product information visit us at [www.national.com](http://www.national.com)



**National Semiconductor**  
Americas Technical  
Support Center  
Email: [support@nsc.com](mailto:support@nsc.com)  
Tel: 1-800-272-9959

**National Semiconductor Europe**  
Technical Support Center  
Email: [europe.support@nsc.com](mailto:europe.support@nsc.com)

**National Semiconductor Asia**  
Pacific Technical Support Center  
Email: [ap.support@nsc.com](mailto:ap.support@nsc.com)

**National Semiconductor Japan**  
Technical Support Center  
Email: [jpn.feedback@nsc.com](mailto:jpn.feedback@nsc.com)