

54F/74F64

4-2-3-2-Input AND-OR-Invert Gate

General Description

This device contains gates configured to perform a 4-2-3-2 input AND-OR-INVERT function.

Commercial	Military	Package Number	Package Description
74F64PC		N14A	14-Lead (0.300" Wide) Molded Dual-In-Line
	54F64DM (Note 2)	J14A	14-Lead Ceramic Dual-In-Line
74F64SC (Note 1)		M14A	14-Lead (0.150" Wide) Molded Small Outline, JEDEC
	54F64FM (Note 2)	W14B	14-Lead Cerpack
	54F64LM (Note 2)	E20A	20-Lead Ceramic Leadless Chip Carrier, Type C

Note 1: Devices also available in 13" reel. Use suffix = SCX.

Note 2: Military grade device with environmental and burn-in processing. Use suffix = DMQB, FMQB and LMQB.

Logic Symbol

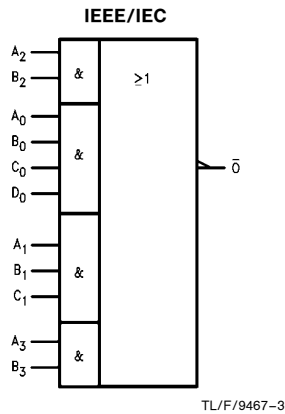

Connection Diagrams

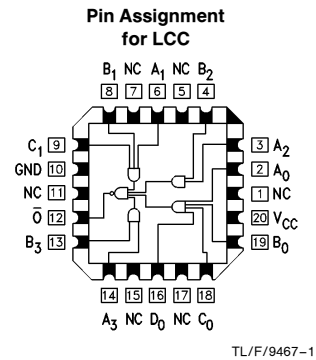
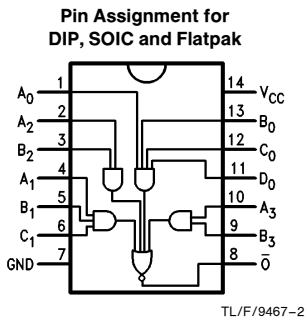

Unit Loading/Fan Out

Pin Names	Description	54F/74F	
		U.L. HIGH/LOW	Input I_{IH}/I_{IL} Output I_{OH}/I_{OL}
A_n, B_n, C_n, D_n	Inputs	1.0/1.0	20 μ A/ -0.6 mA
\bar{O}	Output	50/33.3	-1 mA/20 mA

TRI-STATE® is a registered trademark of National Semiconductor Corporation.

Absolute Maximum Ratings (Note 1)

If Military/Aerospace specified devices are required, please contact the National Semiconductor Sales Office/Distributors for availability and specifications.

Storage Temperature	-65°C to +150°C
Ambient Temperature under Bias	-55°C to +125°C
Junction Temperature under Bias	-55°C to +175°C
Plastic	-55°C to +150°C
V _{CC} Pin Potential to Ground Pin	-0.5V to +7.0V
Input Voltage (Note 2)	-0.5V to +7.0V
Input Current (Note 2)	-30 mA to +5.0 mA
Voltage Applied to Output in HIGH State (with V _{CC} = 0V)	
Standard Output	-0.5V to V _{CC}
TRI-STATE® Output	-0.5V to +5.5V

Current Applied to Output in LOW State (Max) twice the rated I_{OL} (mA)

Note 1: Absolute maximum ratings are values beyond which the device may be damaged or have its useful life impaired. Functional operation under these conditions is not implied.

Note 2: Either voltage limit or current limit is sufficient to protect inputs.

Recommended Operating Conditions

Free Air Ambient Temperature	
Military	-55°C to +125°C
Commercial	0°C to +70°C
Supply Voltage	
Military	+4.5V to +5.5V
Commercial	+4.5V to +5.5V

DC Electrical Characteristics

Symbol	Parameter	54F/74F			Units	V _{CC}	Conditions
		Min	Typ	Max			
V _{IH}	Input HIGH Voltage	2.0			V		Recognized as a HIGH Signal
V _{IL}	Input LOW Voltage			0.8	V		Recognized as a LOW Signal
V _{CD}	Input Clamp Diode Voltage			-1.2	V	Min	I _{IN} = -18 mA
V _{OH}	Output HIGH Voltage	54F 10% V _{CC} 74F 10% V _{CC} 74F 5% V _{CC}	2.5 2.5 2.7		V	Min	I _{OH} = -1 mA I _{OH} = -1 mA I _{OH} = -1 mA
V _{OL}	Output LOW Voltage	54F 10% V _{CC} 74F 10% V _{CC}		0.5 0.5	V	Min	I _{OL} = 20 mA I _{OL} = 20 mA
I _{IH}	Input HIGH Current	54F 74F		20.0 5.0	μA	Max	V _{IN} = 2.7V
I _{BVI}	Input HIGH Current Breakdown Test	54F 74F		100 7.0	μA	Max	V _{IN} = 7.0V
I _{CEX}	Output High Leakage Current	54F 74F		250 50	μA	Max	V _{OUT} = V _{CC}
V _{ID}	Input Leakage Test	74F	4.75		V	0.0	I _{ID} = 1.9 μA All Other Pins Grounded
I _{OD}	Output Leakage Circuit Current	74F		3.75	μA	0.0	V _{IOD} = 150 mV All Other Pins Grounded
I _{IL}	Input LOW Current			-0.6	mA	Max	V _{IN} = 0.5V
I _{OS}	Output Short-Circuit Current			-60	mA	Max	V _{OUT} = 0V
I _{CCH}	Power Supply Current		1.9	2.8	mA	Max	V _O = HIGH
I _{CCL}	Power Supply Current		3.1	4.7	mA	Max	V _O = LOW

AC Electrical Characteristics

Symbol	Parameter	74F			54F		74F		Units
		T _A = +25°C V _{CC} = +5.0V C _L = 50 pF			T _A , V _{CC} = Mil C _L = 50 pF		T _A , V _{CC} = Com C _L = 50 pF		
		Min	Typ	Max	Min	Max	Min	Max	
t _{PLH}	Propagation Delay	2.5	4.6	6.5	2.5	8.5	2.5	7.5	ns
t _{PHL}	A _n , B _n , C _n , D _n to \bar{O}	1.5	3.2	4.5	1.5	6.5	1.5	5.5	

Ordering Information

The device number is used to form part of a simplified purchasing code where the package type and temperature range are defined as follows:

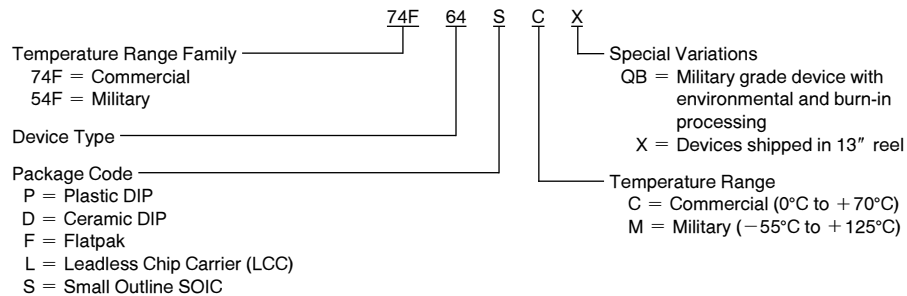

Physical Dimensions inches (millimeters)

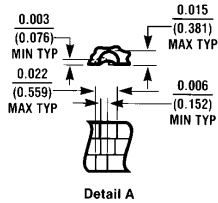
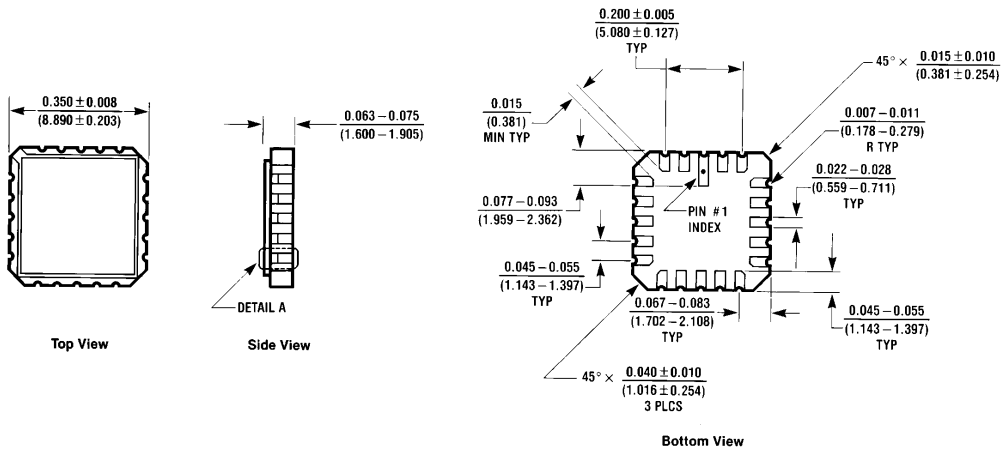

20-Lead Ceramic Leadless Chip Carrier (L)
NS Package Number E20A

E20A (REV D)

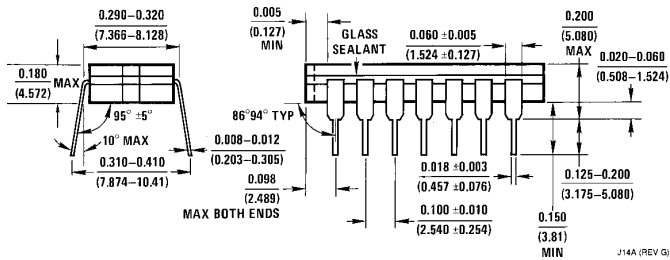
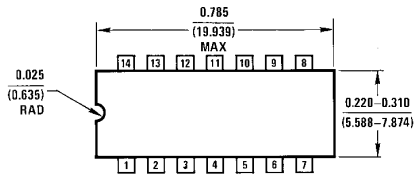

14-Lead Ceramic Dual-In-Line Package (D)
NS Package Number J14A

J14A (REV G)

Physical Dimensions inches (millimeters) (Continued)

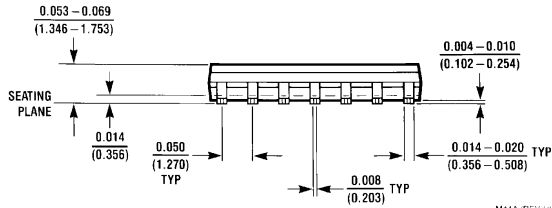
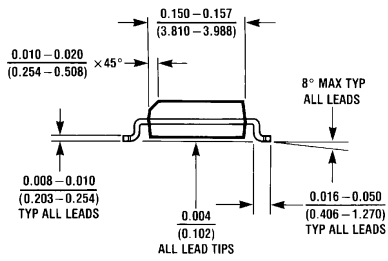
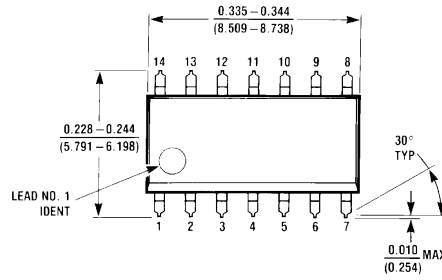

**14-Lead (0.150" Wide) Molded Small Outline, JEDEC (S)
NS Package Number M14A**

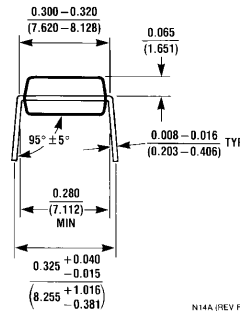
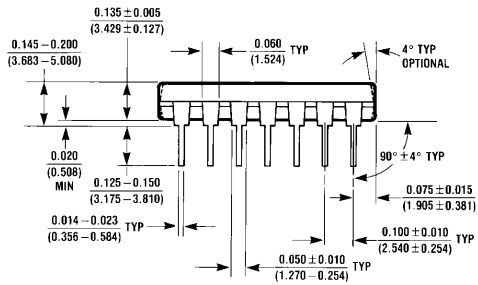
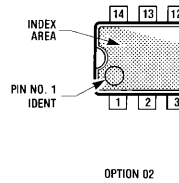
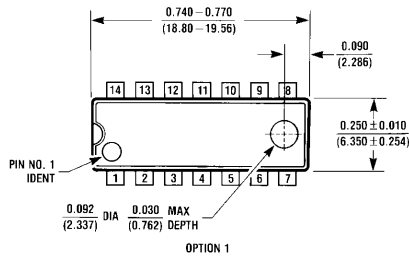

**14-Lead (0.300" Wide) Molded Dual-In-Line Package (P)
NS Package Number N14A**

Physical Dimensions inches (millimeters) (Continued)

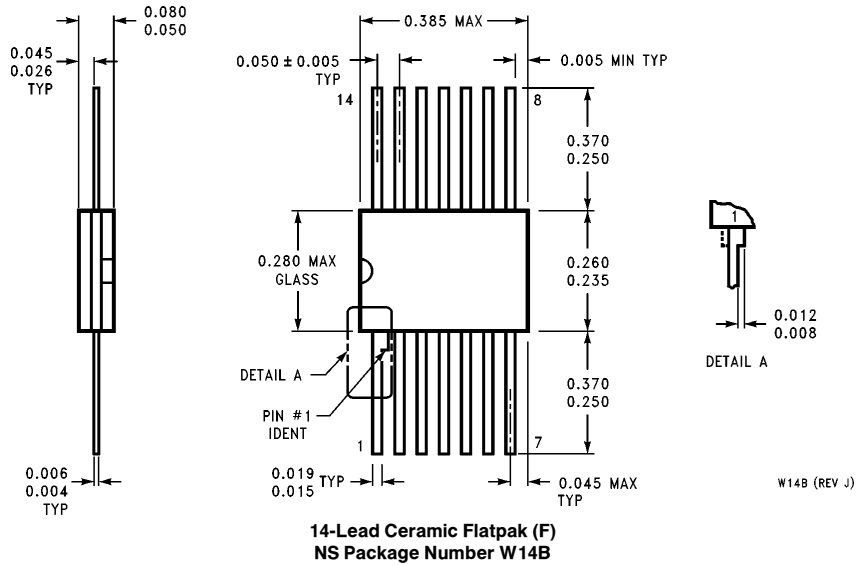

LIFE SUPPORT POLICY

NATIONAL'S PRODUCTS ARE NOT AUTHORIZED FOR USE AS CRITICAL COMPONENTS IN LIFE SUPPORT DEVICES OR SYSTEMS WITHOUT THE EXPRESS WRITTEN APPROVAL OF THE PRESIDENT OF NATIONAL SEMICONDUCTOR CORPORATION. As used herein:

1. Life support devices or systems are devices or systems which, (a) are intended for surgical implant into the body, or (b) support or sustain life, and whose failure to perform, when properly used in accordance with instructions for use provided in the labeling, can be reasonably expected to result in a significant injury to the user.
2. A critical component is any component of a life support device or system whose failure to perform can be reasonably expected to cause the failure of the life support device or system, or to affect its safety or effectiveness.



National Semiconductor Corporation
1111 West Bardin Road
Arlington, TX 76017
Tel: 1(800) 272-9959
Fax: 1(800) 737-7018

National Semiconductor Europe
Fax: (+49) 0-180-530 85 86
Email: cnjwge@tevm2.nsc.com
Deutsch Tel: (+49) 0-180-530 85 85
English Tel: (+49) 0-180-532 78 32
Français Tel: (+49) 0-180-532 93 58
Italiano Tel: (+49) 0-180-534 16 80

National Semiconductor Hong Kong Ltd.
19th Floor, Straight Block,
Ocean Centre, 5 Canton Rd.
Tsimshatsui, Kowloon
Hong Kong
Tel: (852) 2737-1600
Fax: (852) 2736-9960

National Semiconductor Japan Ltd.
Tel: 81-043-299-2309
Fax: 81-043-299-2408

National does not assume any responsibility for use of any circuitry described, no circuit patent licenses are implied and National reserves the right at any time without notice to change said circuitry and specifications.