

NUP2105

Features

- ◆ Working voltages : 24V
- ◆ Low capacitance
- ◆ Low leakage current: 1uA @ V_{RWM}
- ◆ Low clamping voltage
- ◆ Response Time is < 1 ns

SOT-23

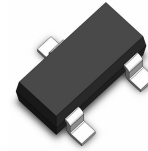

Applications

- ◆ CAN、RS-232&RS-485
- ◆ Audio/Video Inputs
- ◆ Wireless Network Systems
- ◆ Digit Video Interface (DVI)

PIN Configuration

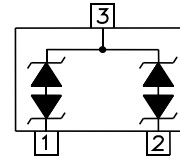

Mechanical Characteristics

- ◆ SOT23 package
- ◆ Molding Compound Flammability Rating: UL 94V-0
- ◆ Quantity Per Reel:3,000pcs
- ◆ Reel size: 7inch

Absolute Maximum Rating

Symbol	Parameter	Value	Units
T_{LST}	Lead Soldering Temperature	260 (10 sec.)	°C
T_{STG}	Storage Temperature Range	-55 to +125	°C
T_{OPT}	Operating Temperature Range	-55 to +125	°C
V_{ESD}	ESD per IEC 61000-4-2(Air)	±30	KV
	ESD per IEC 61000-4-2 (Contact)	±30	

NUP2105

I-V Curve Characteristics

Symbol	Parameter
I_{PP}	Maximum Peak Pulse Current
V_C	Clamping Voltage @ I_{PP}
V_{RWM}	Working Peak Reverse Voltage
I_R	Maximum Reverse Leakage Current @ V_{RWM}
V_{BR}	Breakdown Voltage @ I_T
I_T	Test Current

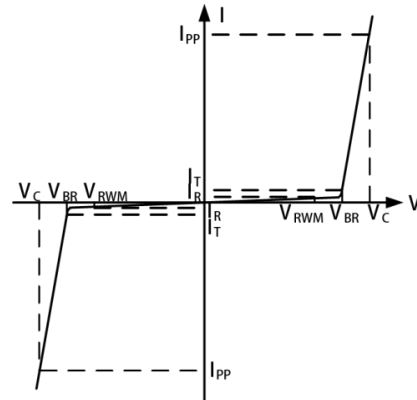

Bi-Directional TVS

Electrical Characteristics (@ $T_A=25^\circ\text{C}$ Unless Otherwise Specified)

Symbol	Test Condition	Minimum	Typical	Maximum	Units
V_{RWM}	--	--	--	24	V
I_R	$V_{RWM}=24\text{V}, T=25^\circ\text{C}$	--	--	1	μA
V_{BR}	$I_T = 1\text{mA}$	26.7	--	31.5	V
V_C	$I_{PP}=6\text{A}, t_p=8/20\mu\text{s}$	--	--	70	V
C_J	$V_R=0\text{V}, f=1\text{MHz}$	--	20	--	pF

Characteristic Curves

Fig1. 8/20 μs Pulse Waveform

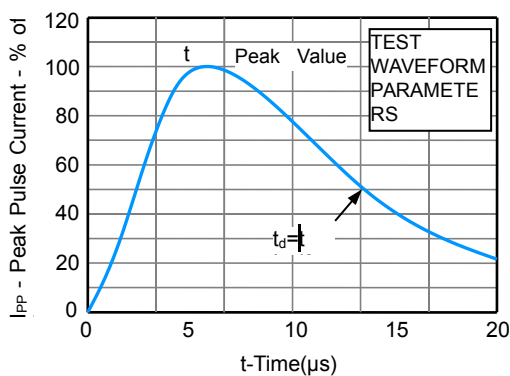
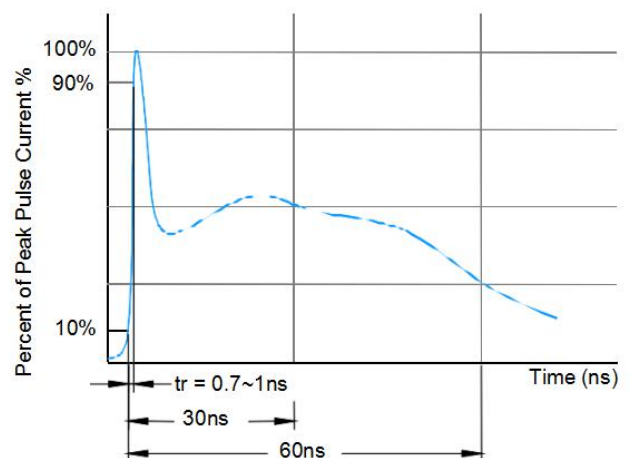

Fig2. ESD Pulse Waveform (according to IEC 61000-4-2)



NUP2105

Characteristic Curves (Continue)

Fig3. ESD Pulse Waveform (according to IEC 61000-4-2)

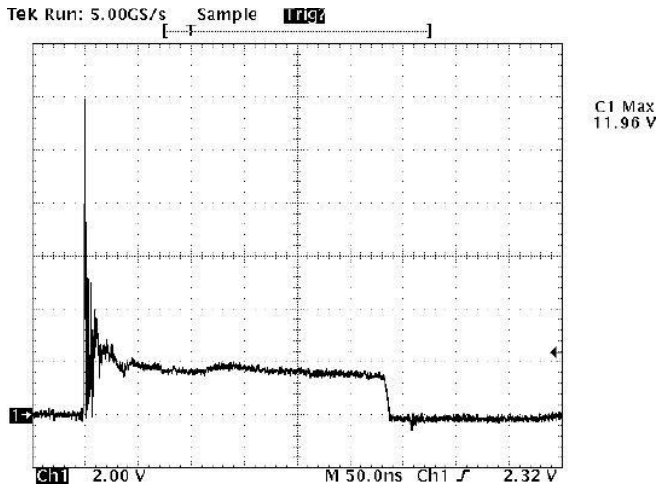
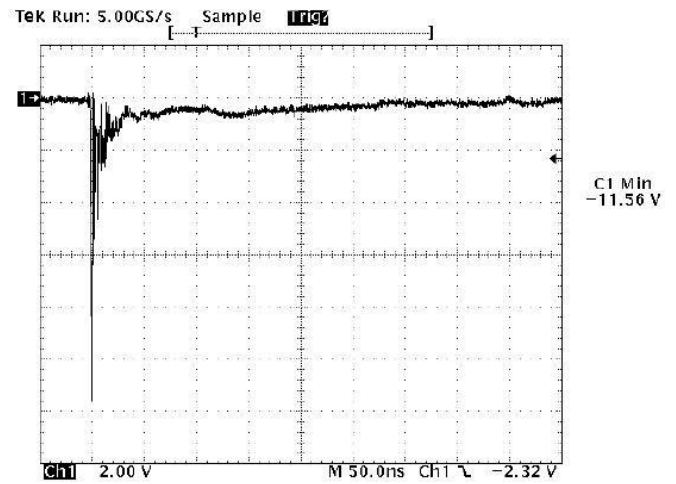
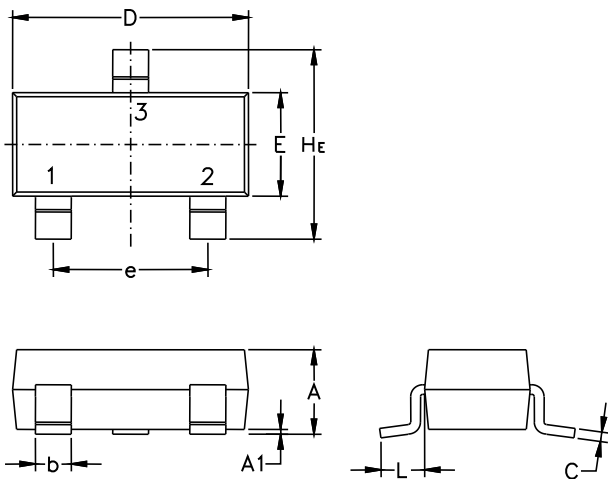

Fig4. ESD Clamping (-8KV Contacter IEC61000-4-2)



SOT23 Package Outline & Dimensions (Unit: mm)



Symbol	Millimeters			Inches		
	Min.	Nom.	Max.	Min.	Nom.	Max.
A	0.89	1.00	1.11	0.035	0.040	0.044
A1	0.01	0.06	0.10	0.001	0.002	0.004
b	0.37	0.44	0.50	0.15	0.18	0.020
c	0.09	0.13	0.18	0.003	0.005	0.007
D	2.80	2.90	3.04	0.110	0.114	0.120
E	1.20	1.30	1.40	0.047	0.051	0.055
e	1.78	1.90	2.04	0.070	0.075	0.081
L	0.35	0.54	0.69	0.014	0.021	0.029
He	2.10	2.40	2.64	0.083	0.094	0.104

Soldering Footprint

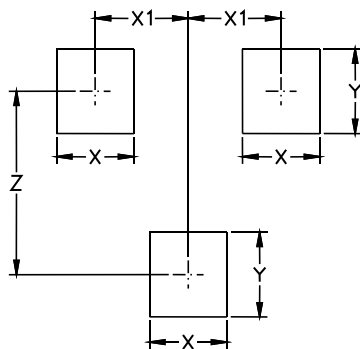

Symbol	Millimeters	Inches
X	0.80	0.031
X1	0.95	0.037
Y	0.90	0.035
Z	2.00	0.079