

# BV03C

## DESCRIPTION

The BV03C are ultra low capacitance transient voltage suppressor arrays, designed to protect applications such as portable electronics and SMART phones. This series is available in both unidirectional and bidirectional configurations and is rated at 350 Watts for an 8/20 $\mu$ s wave shape.

The BV03C meets IEC 61000-4-2 (ESD) and IEC 61000-4-4 (EFT) requirements. At higher operating frequencies or faster edge rates, insertion loss and signal integrity are a major concern. This series offers a ultra low capacitance and low leakage current in a miniature SOD-323 package.

## ORDERING INFORMATION

- ◇ Package: SOD-323
- ◇ Material: Halogen free
- ◇ Packing: Tape & Reel
- ◇ Quantity per reel: 3,000pcs

## PIN CONFIGURATION

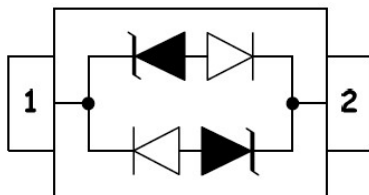

## FEATURES

- ◇ Transient protection for high-speed data lines
  - IEC 61000-4-2 (ESD)  $\pm 8\text{kV}$  (Contact)
  - $\pm 15\text{kV}$  (Air)
  - IEC 61000-4-4 (EFT) 40A (5/50 ns)
- ◇ Protects one I/O line (bidirectional)
- ◇ Working voltages : 3V
- ◇ Low clamping voltage
- ◇ Low leakage current
- ◇ Response time is < 1 ns

## MACHANICAL DATA

- ◇ SOD-323 package
- ◇ Flammability Rating: UL 94V-0
- ◇ Packaging: Tape and Reel
- ◇ High temperature soldering guaranteed:
  - 260 $^{\circ}$ C/10s
- ◇ Reel size: 7 inch
- ◇ MSL1

## APPLICATIONS

- ◇ Cell Phone Handsets and Accessories
- ◇ Microprocessor based equipment
- ◇ Personal Digital Assistants (PDA's)
- ◇ Notebooks, Desktops, and Servers
- ◇ Portable Instrumentation
- ◇ Peripherals
- ◇ USB Interface

## PACKAGE OUTLINE

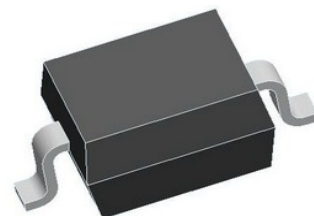

**ABSOLUTE MAXIMUM RATING**

Symbol	Parameter	Value	Units
$V_{ESD}$	ESD per IEC 61000-4-2 (Air)	$\pm 15$	kV
	ESD per IEC 61000-4-2 (Contact)	$\pm 8$	
$P_{PP}$	Peak Pulse Power (8/20 $\mu$ s)	350	W
$T_{OPT}$	Operating Temperature	-55/+150	$^{\circ}$ C
$T_{STG}$	Storage Temperature	-55/+150	$^{\circ}$ C
$T_L$	Lead Soldering Temperature	260	$^{\circ}$ C

**ELECTRICAL CHARACTERISTICS (Tamb=25 $^{\circ}$ C)**

PART NUMBER	DEVICE MARKING	$V_{RWM}$	$V_B@1mA$	$V_C@1A$	$V_C@I_{pp}$		$V_C@I_{pp}$		$I_R$ ( $\mu$ A)	$C_T$ (pF)
		(V) Max	(V) Min	(V) Max	Max	$I_{pp}$ (A)	Max	$I_{pp}$ (A)		
BV03C	CC	3.0	4.0	7.0	13.9	8	20.0	20	5	0.8

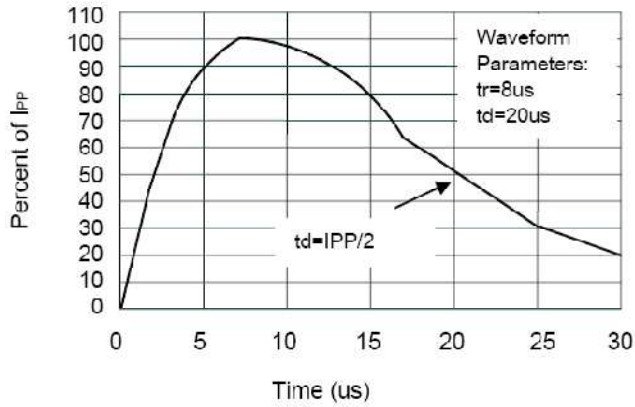
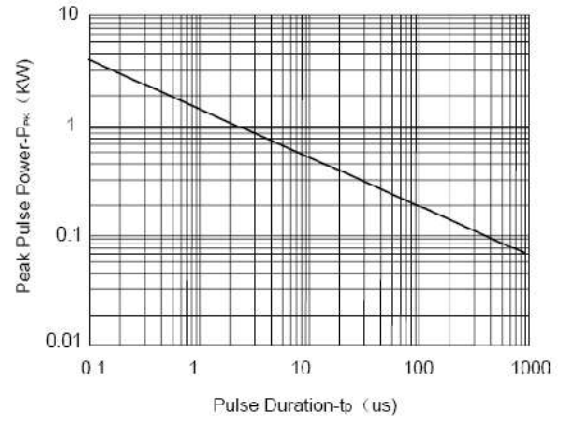
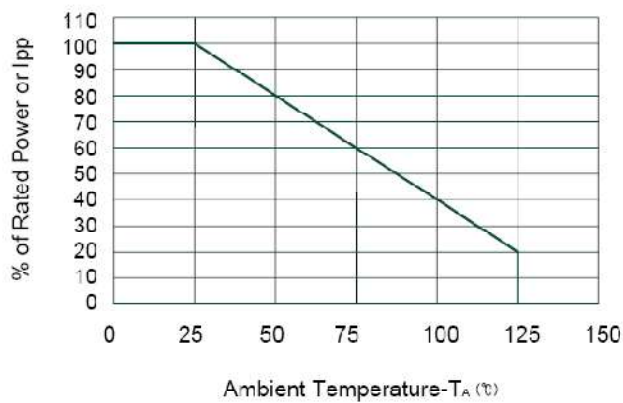
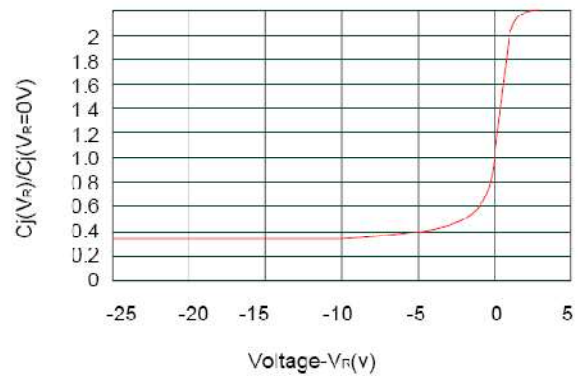
**ELECTRICAL CHARACTERISTICS CURVE**

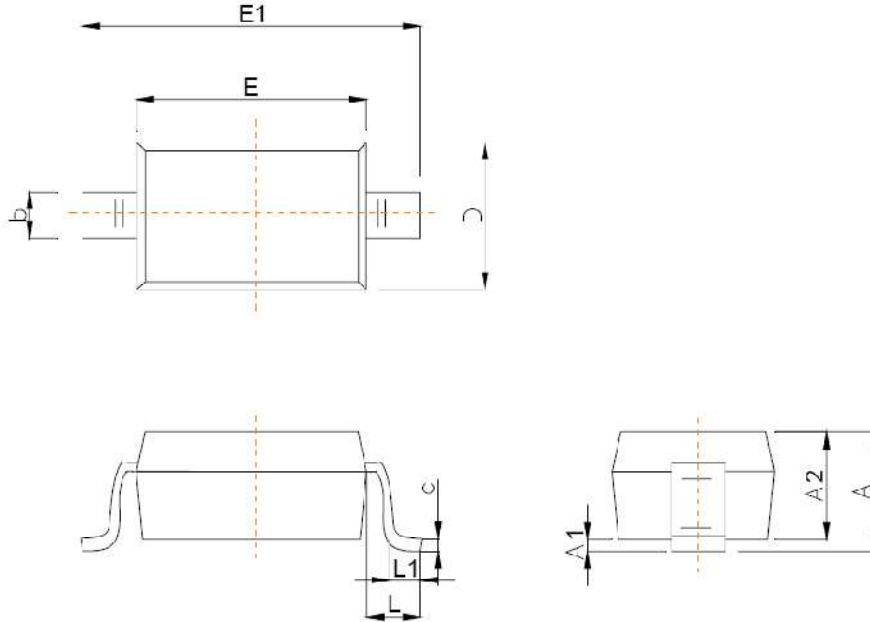
**Pulse Waveform**

**Non-Repetitive Peak Pulse Power vs. Pulse Time**

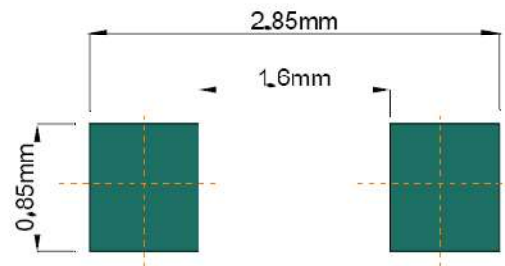
**Power Derating Curve**

**Junction Capacitance vs. Reverse Voltage**

**SOD-323 PACKAGE OUTLINE DIMENSIONS**

Symbol	Dimensions In Millimeters	
	Min	Max
A		1.00
A1	0.000	0.100
A2	0.800	0.900
b	0.250	0.350
c	0.080	0.150
D	1.200	1.400
E	1.600	1.800
E1	2.500	2.700
e	1.800	2.040
L	0.475 REF	
L1	0.250	0.400
θ	0°	8°

**Recommended Pad outline**