

1N5819WS S4

Schottky Barrier Diode

FEATURES

- Low Forward Voltage Drop
- Guard Ring Construction for Transient Protection
- Negligible Reverse Recovery Time
- Low Capacitance

PINNING

PIN	DESCRIPTION
1	Cathode
2	Anode



Top View

Simplified outline SOD-323 and symbol

MECHANICAL DATA

- Case: SOD-323
- Terminals: Solderable per MIL-STD-750, Method 2026
- Approx. Weight: 5.48mg / 0.00019oz

Maximum Ratings and Electrical characteristics

Ratings at 25 °C ambient temperature unless otherwise specified.

Parameter	Symbols	1N5819WS S4	Units
Peak Repetitive Reverse Voltage	V_{RRM}	40	V
RMS reverse voltage	V_{RMS}	28	V
Working Peak Reverse Voltage	V_{DC}	40	V
Peak Forward Surge Current, 8.3ms single half sine-wave superimposed on rated load (JEDEC method)	I_{FSM}	13	A
Maximum Instantaneous Forward Voltage	V_F	$I_F=20mA$	0.37
		$I_F=200mA$	0.60
Power Dissipation	P_D	200	mW
Reverse current	I_R	5	μA
Thermal Resistance, Junction to Ambient Air	$R_{\theta JA}$	300	$^{\circ}C/W$
Reverse voltage	$V_{(BR)R}$	40	V
Reverse recovery time	t_{rr}	10	ns
Forward Continuons Current	I_{FM}	350	mA
Total capacitance	C_{tot}	50	pF
Junction temperature	T_j	125	$^{\circ}C$
Storage temperature	T_{stg}	-55 ~ +150	$^{\circ}C$

1N5819WS S4

Fig.1 Power Derating Curve

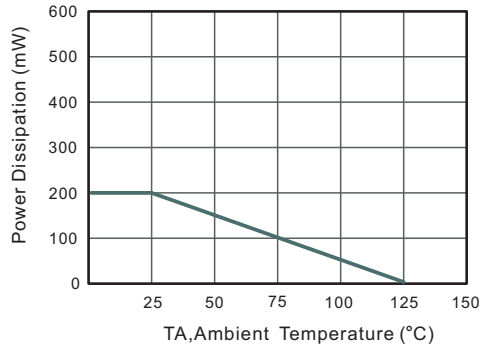

Fig.2 Typical Reverse Characteristics

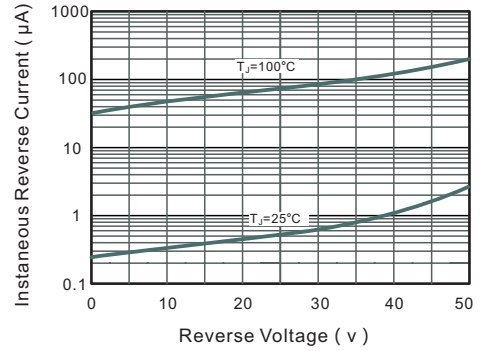

Fig.3 Forward Characteristics

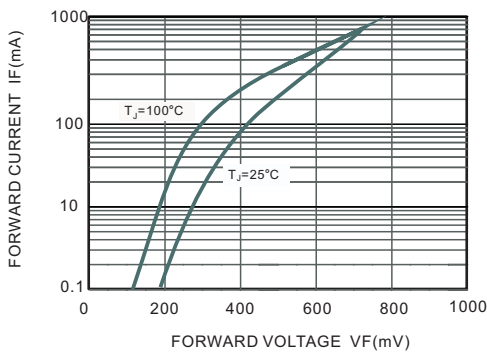

Fig.4 Maximum Non-Repetitive Peak Forward Surge Current

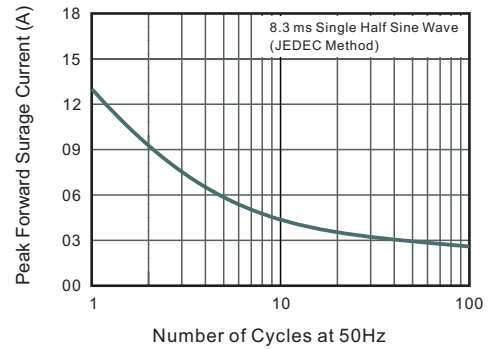

Fig.5 Typical Junction Capacitance

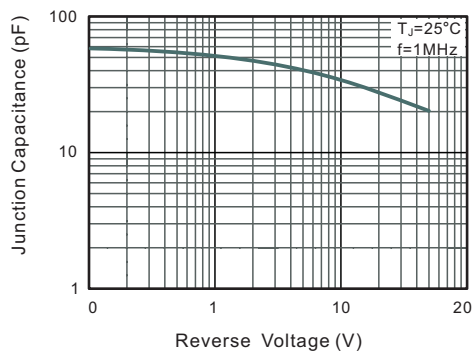
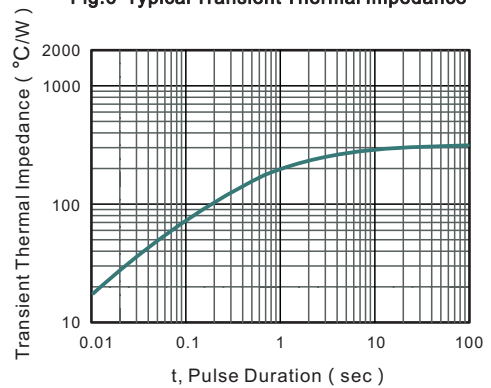

Fig.6 Typical Transient Thermal Impedance



1N5819WS S4

PACKAGE OUTLINE

Plastic surface mounted package; 2 leads

SOD-323

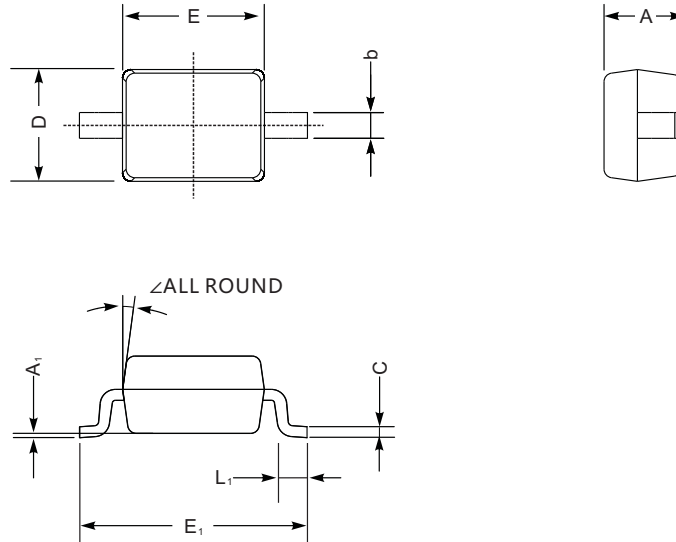

SOD-323 mechanical data

UNIT		A	C	D	E	E ₁	b	L ₁	A ₁	∠
mm	max	1.1	0.15	1.4	1.8	2.75	0.4	0.45	0.2	9°
	min	0.8	0.08	1.2	1.4	2.55	0.25	0.2	—	
mil	max	43	5.9	55	70	108	16	16	8	
	min	32	3.1	47	63	100	9.8	7.9	—	

The recommended mounting pad size

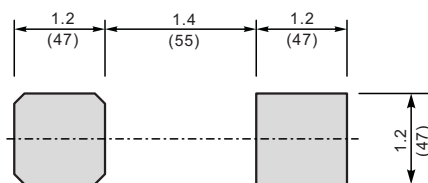

Unit: $\frac{\text{mm}}{\text{mil}}$