

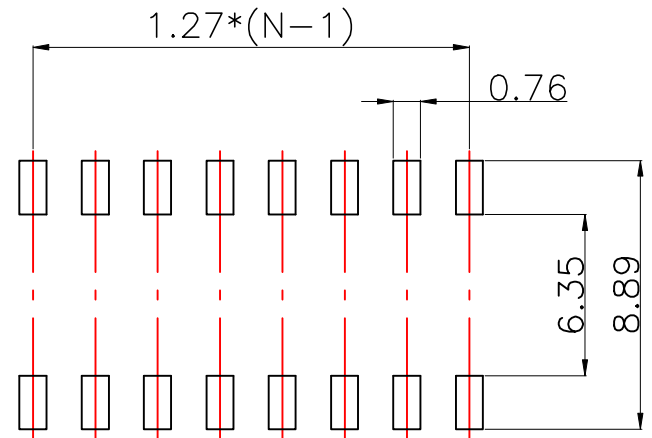

REV.	ECN NO OR DESCRIPTION	REVISED	DATE

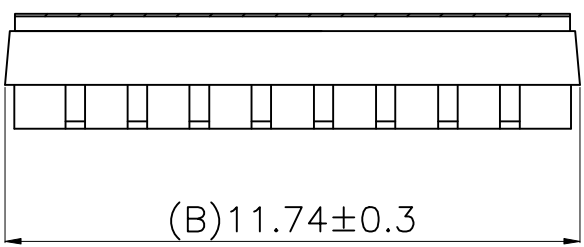
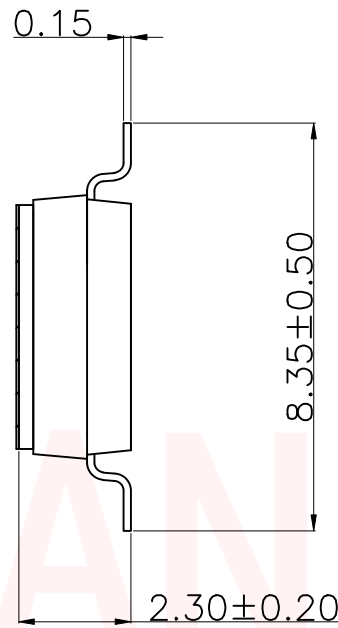
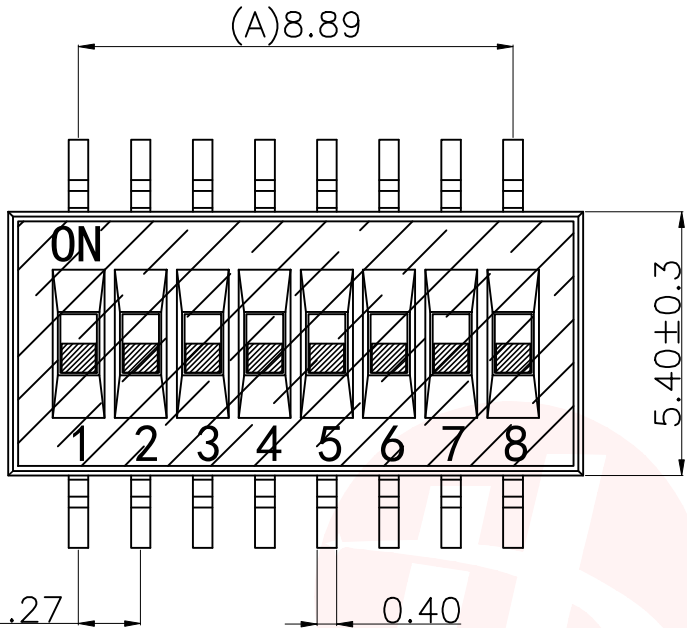

[P.C.B.LAYOUT]

NOTES:

1.Specification:

- 1>.Operation force: 1000gf Max.
- 2>.Operation Temperature: -30°C to +85°C.
- 3>.Storage Temperature: -40°C to +85°C.
- 4>.Mechanical Life: 1000 cycles operations.
- 5>.Resistance to Soldering: 260±5°C for 3-5 Seconds.

2.PLATING:

- 1>.GOLD flash 1u" (min) SOLDERTAIL, 3u" GOLD PLATING ON THE CONTACT AREA.

3.ELECTRICAL:

- 1>.Non-switch Rating:100mA at 50V DC.
- 2>.Switching Rating: 25mA at 24V DC.
- 3>.Contact Resistance: Inital 50mΩ Max. Contact Resistance: After life 100mΩ Max.
- 4>.Insulation Resistance:100MΩ Min at 100VDC.
- 5>.Dielectric Strength: 300V AC for 60seconds.
- 6>.Switch Capacitance: 5PF Max at 1MHZ.

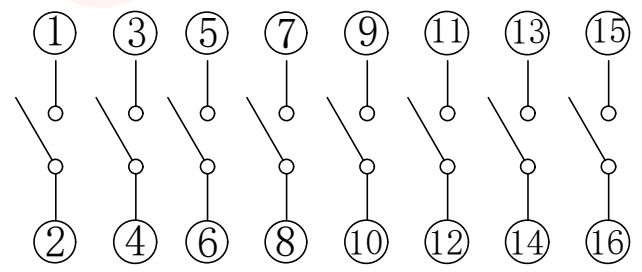

[Schematic]

UNLESS OTHERWISE SPECIFIED TOLERANCES		东莞市汉博电子科技有限公司 DONGGUAN HANBO TECHNOLOGY CO., LTD			
DECIMALS:	ANGLES:	TITLE 1.27 spacing dial switch series			
X :±0.30	X :±2°	DWN	xiong	PART NO. DS-08P	
X.X :±0.20	X.X :±1°	CHKD	lee	SCALE:1:1	UNIT: mm
X.XX :±0.10		APVD	wang	SIZE: A4	SHEET:10F 1
		REV: A4			
CUSTOMER COPY					