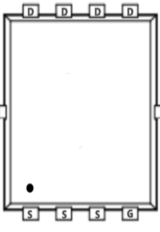
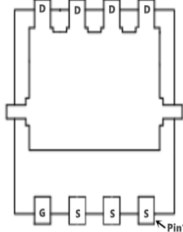
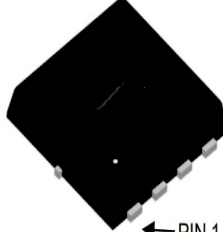
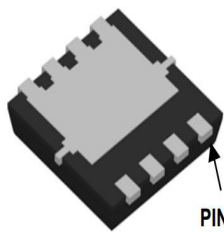
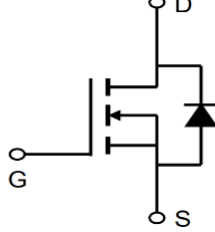

TM80N04DF

N-Channel Enhancement Mosfet

<p>General Description</p> <ul style="list-style-type: none"> • Low $R_{DS(ON)}$ • RoHS and Halogen-Free Compliant <p>Applications</p> <ul style="list-style-type: none"> • Load switch • PWM 	<p>General Features</p> <p>$V_{DS} = 40V$ $I_D = 80A$</p> <p>$R_{DS(ON)} = 4.2m\Omega$ (typ.) @ $V_{GS}=10V$</p> <p>100% UIS Tested 100% R_g Tested</p> 
--	--

DF:DFN3x3_8L

Marking: 80N04 OR 006

Absolute Maximum Ratings: ($T_C=25^\circ C$ unless otherwise noted)

Symbol	Parameter	Ratings	Units
V_{DS}	Drain-Source Voltage	40	V
V_{GS}	Gate-Source Voltage	± 20	V
I_D	Continuous Drain Current-Continuous ($T_C=25^\circ C$)	80	A
	Continuous Drain Current- $T_C=100^\circ C$	44.3	
I_{DM}	Drain Current – Pulsed ¹	280	A
P_D	Power Dissipation ($T_C=25^\circ C$)	52	W
	Power Dissipation – Derate above $25^\circ C$	0.42	W/ $^\circ C$
T_J, T_{STG}	Operating and Storage Junction Temperature Range	-55 to +150	$^\circ C$

Thermal Characteristics:

Symbol	Parameter	Max	Units
$R_{\theta JC}$	Thermal Resistance, Junction to Case	2.	$^\circ C/W$
$R_{\theta JA}$	Thermal Resistance, Junction to Ambient	62	

TM80N04DF

N-Channel Enhancement Mosfet

Electrical Characteristics: ($T_C=25^{\circ}\text{C}$ unless otherwise noted)

Symbol	Parameter	Conditions	Min	Typ	Max	Units
Off Characteristics						
BV_{DSS}	Drain-Source Breakdown Voltage	$V_{GS}=0V, I_D=250\ \mu\text{A}$	40	---	---	V
I_{DSS}	Drain-Source Leakage Current	$V_{GS}=0V, V_{DS}=40V, T_J=25^{\circ}\text{C}$	---	---	1	μA
		$V_{GS}=0V, V_{DS}=32V, T_J=125^{\circ}\text{C}$			10	μA
I_{GSS}	Gate-Source Leakage Current	$V_{GS}=\pm 20V, V_{DS}=0A$	---	---	± 100	nA
On Characteristics						
$V_{GS(th)}$	GATE-Source Threshold Voltage	$V_{GS}=V_{DS}, I_D=250\ \mu\text{A}$	1	1.6	2.5	V
$R_{DS(on)}$	Drain-Source On Resistance ³	$V_{GS}=10V, I_D=20A$	---	4.2	5.5	m Ω
		$V_{GS}=4.5V, I_D=10A$	---	5.3	7	
G_{FS}	Forward Transconductance	$V_{DS}=10V, I_D=10A$	---	16	---	S
Dynamic Characteristics						
C_{iss}	Input Capacitance	$V_{DS}=25V, V_{GS}=0V, f=1\text{MHz}$	---	2410	3600	pF
C_{oss}	Output Capacitance		---	233	400	
C_{rss}	Reverse Transfer Capacitance		---	152	230	
Switching Characteristics						
$t_{d(on)}$	Turn-On Delay Time ^{3,4}	$V_{DD}=20V, V_{GS}=10V, R_G=3.3, I_D=1A$	---	14.2	28	ns
t_r	Rise Time ^{3,4}		---	18.3	36	ns
$t_{d(off)}$	Turn-Off Delay Time ^{3,4}		---	38.8	76	ns
t_f	Fall Time ^{3,4}		---	13.9	28	ns
Q_g	Total Gate Charge ^{3,4}	$V_{DS}=32V, V_{GS}=4.5V, I_D=10A$	---	25	50	nC
Q_{gs}	Gate-Source Charge ^{3,4}		---	6.4	13	nC
Q_{gd}	Gate-Drain "Miller" Charge ^{3,4}		---	12.1	24	nC
Drain-Source Diode Characteristics						
V_{SD}	Source-Drain Diode Forward Voltage ²	$V_{GS}=0V, I_S=1A, T_J=25^{\circ}\text{C}$	---	---	1	V
LS	Reverse Recovery Time	$V_G=V_D=0V, \text{Force Current}$	---	---	80	A
LSM_r	Reverse Recovery Charge		---	---	35	A

Notes:

1. Repetitive Rating : Pulsed width limited by maximum junction temperature.
2. The data tested by pulsed , pulse width $\leq 300\mu\text{s}$, duty cycle $\leq 2\%$.
3. Essentially independent of operating temperature.

TM80N04DF

N-Channel Enhancement Mosfet

Typical Characteristics: ($T_C=25^\circ\text{C}$ unless otherwise noted)

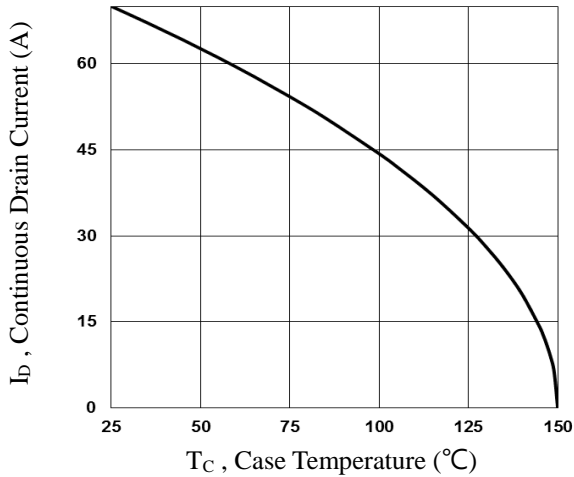

Fig.1 Continuous Drain Current vs. T_C

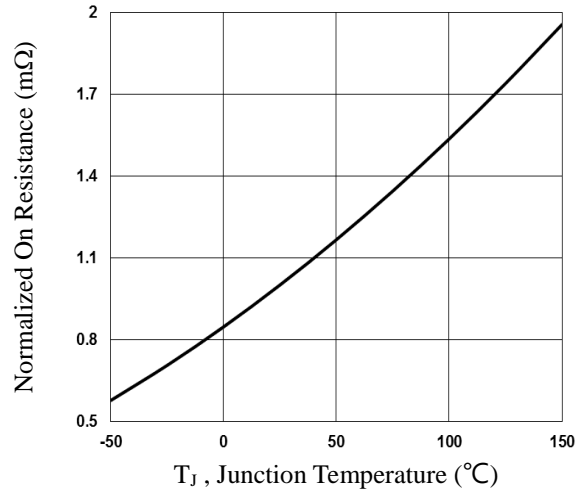

Fig.2 Normalized $R_{DS(on)}$ vs. T_J

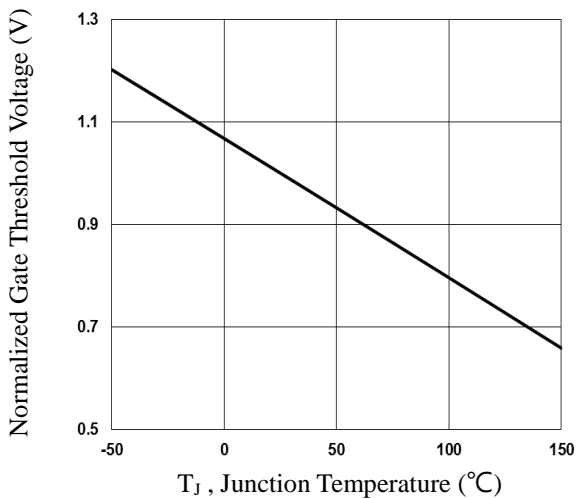

Fig.3 Normalized V_{th} vs. T_J

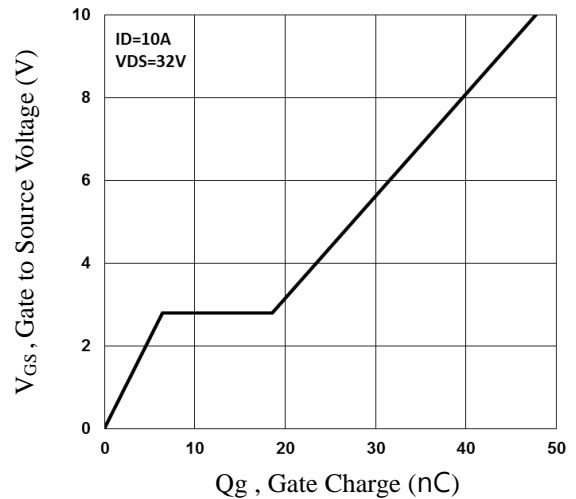

Fig.4 Gate Charge Waveform

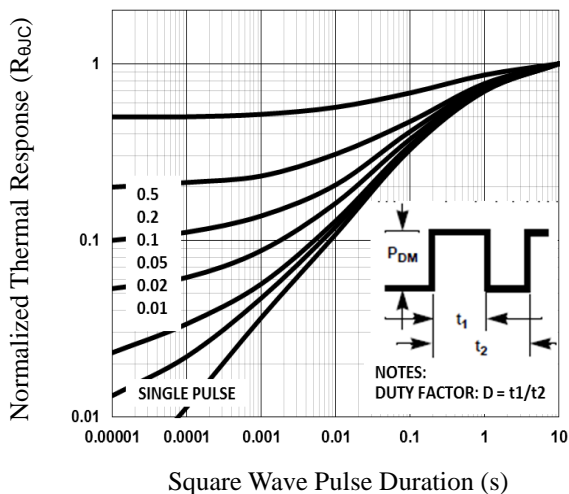

Fig.5 Normalized Transient Impedance

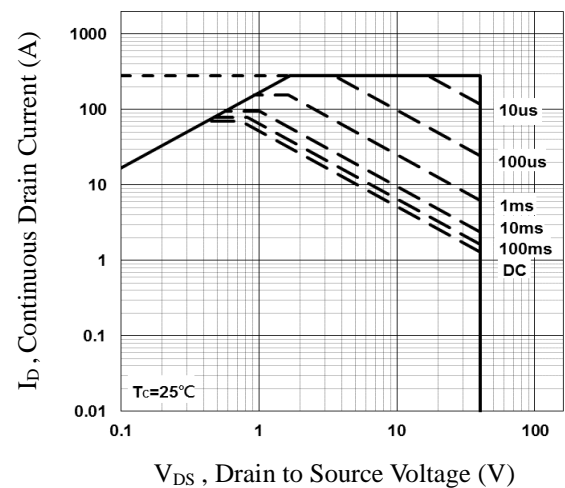

Fig.6 Maximum Safe Operation Area

TM80N04DF

N-Channel Enhancement Mosfet

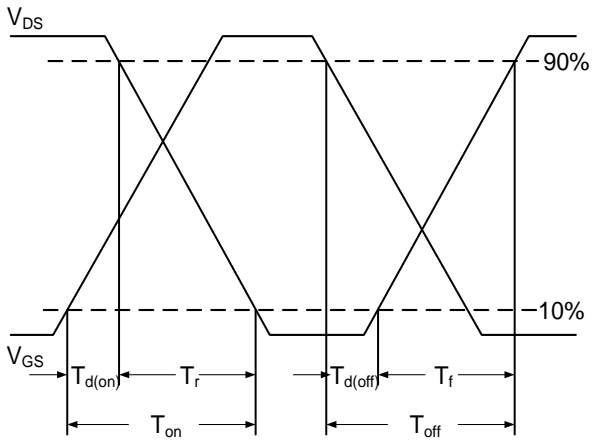

Fig.7 Switching Time Waveform

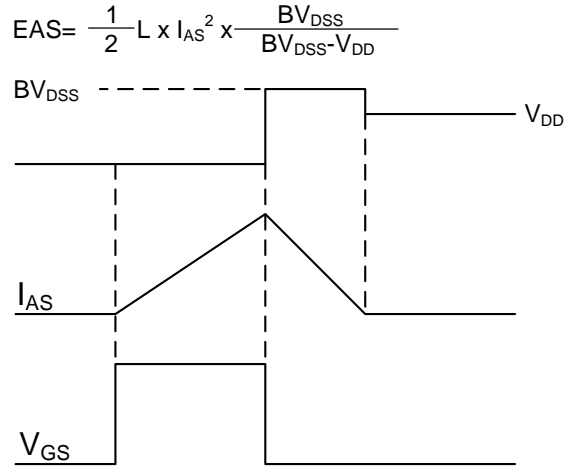
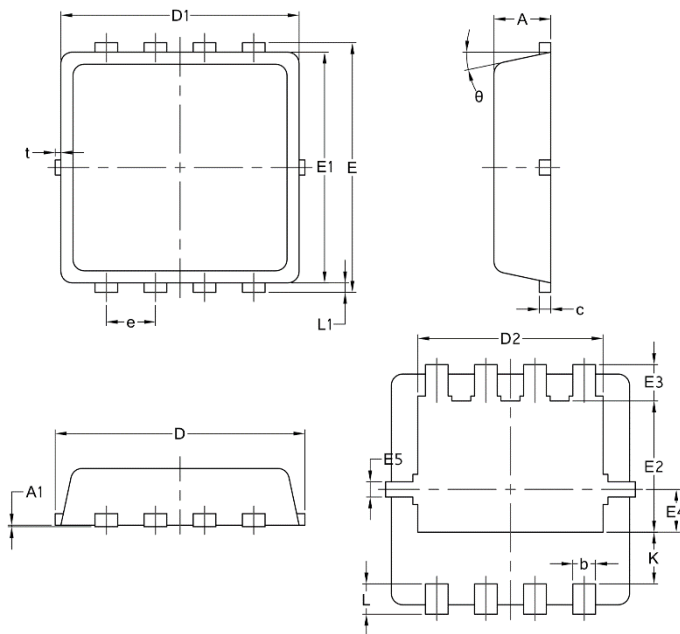

Fig.8 EAS Waveform

Package Mechanical Data:DFN3x3-8L



Symbol	Common		
	mm		
	Mim	Nom	Max
A	0.70	0.75	0.85
A1	/	/	0.05
b	0.20	0.30	0.40
c	0.10	0.152	0.25
D	3.15	3.30	3.45
D1	3.00	3.15	3.25
D2	2.29	2.45	2.65
E	3.15	3.30	3.45
E1	2.90	3.05	3.20
E2	1.54	1.74	1.94
E3	0.28	0.48	0.65
E4	0.37	0.57	0.77
E5	0.10	0.20	0.30
e	0.60	0.65	0.70
K	0.59	0.69	0.89
L	0.30	0.40	0.50
L1	0.06	0.125	0.20
t	0	0.075	0.13
Φ	10	12	14