

μ A318 High-Speed Operational Amplifier

Linear Products

Description

The μ A318 is a Precision High-Speed Operational Amplifier designed for applications requiring wide bandwidth and high slew rate. It features a factor of ten increase in speed over general purpose devices without sacrificing dc performance.

The μ A318 has internal unity gain frequency compensation. This simplifies its application since no external components are necessary for operation. However, unlike most internally compensated amplifiers, external frequency compensation may be added for optimum performance. For inverting applications, feedforward compensation will boost the slew rate to over $150 \text{ V}/\mu\text{s}$ and almost double the bandwidth. Overcompensation can be used with the amplifier for greater stability when maximum bandwidth is not needed. Further, a single capacitor can be added to reduce the 0.1% settling time to under $1 \mu\text{s}$.

The high speed and fast settling time of this op amp makes it useful in a/d converters, oscillators, active filters, sample-and-hold circuits or general-purpose amplifiers. This device is easy to apply and offers a better ac performance than industry standards such as the μ A709.

- 15 MHz SMALL SIGNAL BANDWIDTH
- GUARANTEED $50 \text{ V}/\mu\text{s}$ SLEW RATE
- MAXIMUM BIAS CURRENT OF 500 nA
- OPERATES FROM SUPPLIES OF $\pm 5 \text{ V}$ TO $\pm 20 \text{ V}$
- INTERNAL FREQUENCY COMPENSATION
- INPUT AND OUTPUT OVERLOAD PROTECTED
- PIN COMPATIBLE WITH GENERAL PURPOSE OP AMPS

Absolute Maximum Ratings

Supply Voltage	$\pm 20 \text{ V}$
Power Dissipation (Note 1)	500 mW
Differential Input Current (Note 2)	$\pm 10 \text{ mA}$
Input Voltage (Note 3)	$\pm 15 \text{ V}$
Output Short Circuit Duration	Indefinite
Operating Temperature Range	0°C to $+70^\circ\text{C}$
Storage Temperature Range	-65°C to $+150^\circ\text{C}$
Pin Temperature (Soldering, 60 s)	300°C

Notes

1. The maximum junction temperature of the μ A318 is 150°C for operating at elevated temperatures. The package must be derated based on a thermal resistance of $150^\circ\text{C}/\text{W}$, junction to ambient or $45^\circ\text{C}/\text{W}$, junction to case.
2. The inputs are shunted with back-to-back diodes for overvoltage protection. Therefore, excessive current will flow

Connection Diagram 8-Pin Metal Package

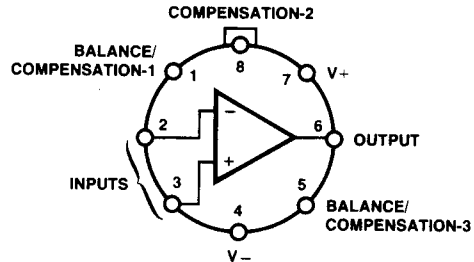

(Top View)

Order Information

Type	Package	Code	Part No.
μ A318	Metal	5W	μ A318HC

Equivalent Circuit

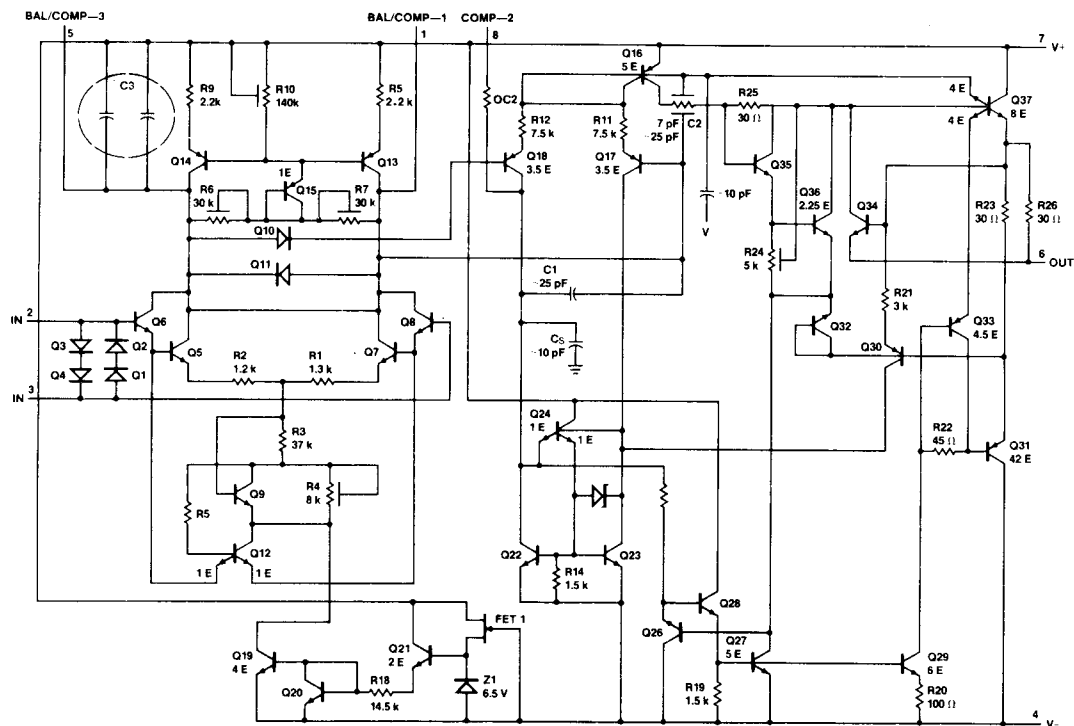

μA318

μA318

Electrical Characteristics $\pm 5 \text{ V} \leq V_S \leq \pm 20 \text{ V}$, $T_A = +25^\circ\text{C}$

Characteristic	Condition	Min	Typ	Max	Unit
Input Offset Voltage			4	10	mV
Input Offset Current			30	200	nA
Input Bias Current			150	500	nA
Input Resistance		0.5	3		MΩ
Supply Current		5	10		mA
Large Signal Voltage Gain	$V_S = \pm 15 \text{ V}$, $V_{OUT} = \pm 10 \text{ V}$, $R_L \geq 2 \text{ k}\Omega$	25	200		V/mV
Slew Rate	$V_S = \pm 15 \text{ V}$, $A_V = 1$	50	70		V/μs
Small Signal Bandwidth	$V_S = \pm 15 \text{ V}$		15		MHz

The following specifications apply for $0^\circ\text{C} < T_A < +70^\circ\text{C}$

Input Offset Voltage				15	mV
Input Offset Current				300	nA
Input Bias Current				750	nA
Large Signal Voltage Gain	$V_S = \pm 15 \text{ V}$, $V_{OUT} = \pm 10 \text{ V}$, $R_L \geq 2 \text{ k}\Omega$	20			V/mV
Output Voltage Swing	$V_S = \pm 15 \text{ V}$, $R_L = 2 \text{ k}\Omega$	± 12	± 13		V
Input Voltage Range	$V_S = \pm 15 \text{ V}$	± 11.5			V
Common-Mode Rejection Ratio		70	100		dB
Supply Voltage Rejection Ratio		65	80		dB

4

Typical Performance Curves

Input Current

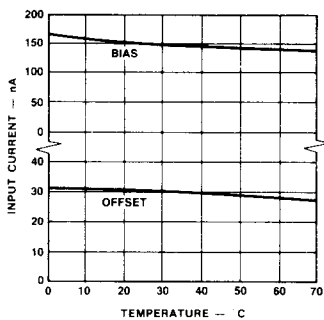

Voltage Gain

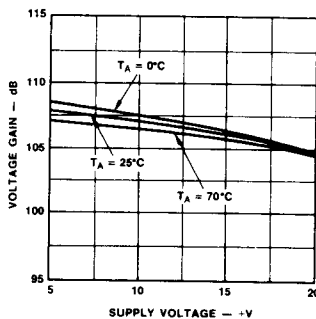

Power Supply Rejection

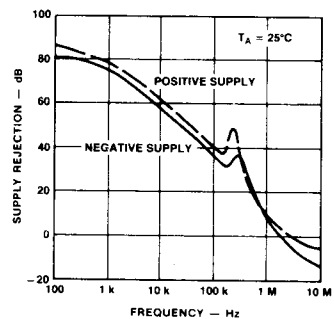

Typical Performance Curves (Cont.)

Input Noise Voltage

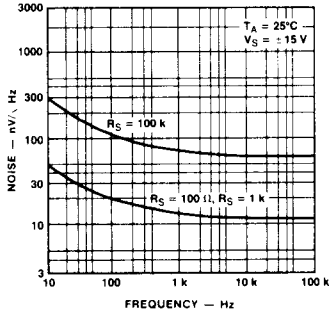

Common Mode Rejection

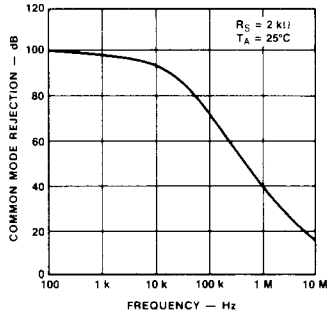

Supply Current

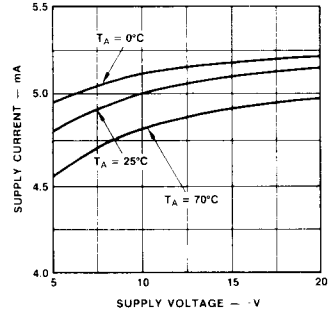

Closed Loop Output Impedance

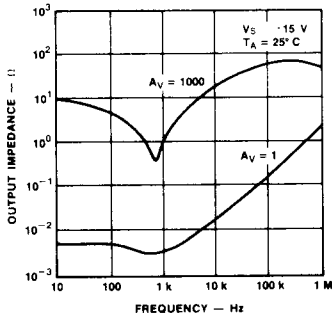

Current Limiting

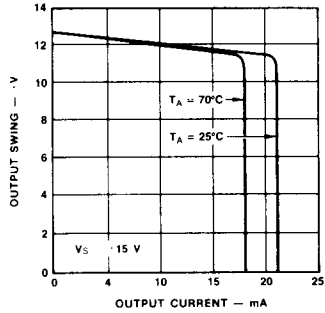

Input Current

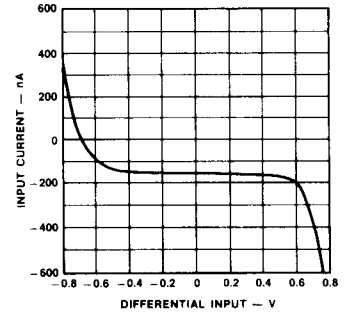

Unity Gain Bandwidth

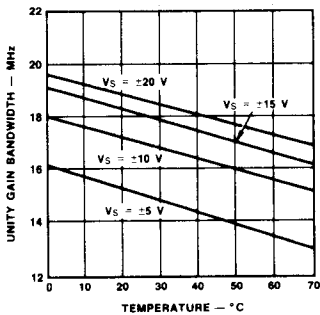

Voltage Follower Slew Rate

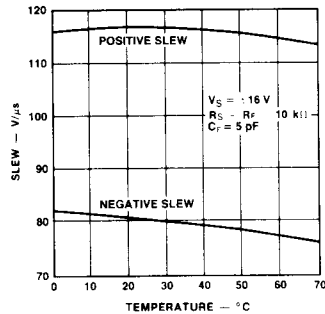

Inverter Settling Time

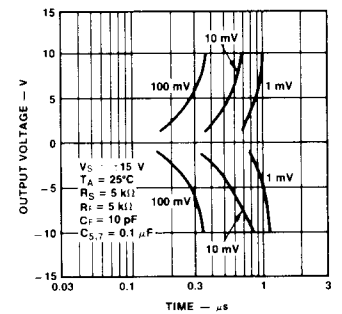

Typical Performance Curves (Cont.)

Large Signal Frequency Response

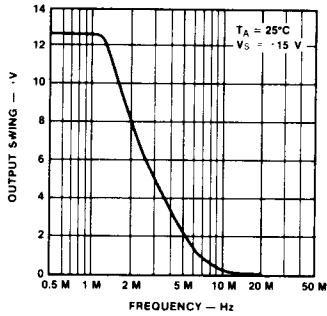

Open Loop Frequency Response

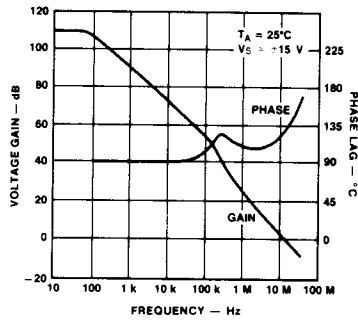

Voltage Follower Pulse Response

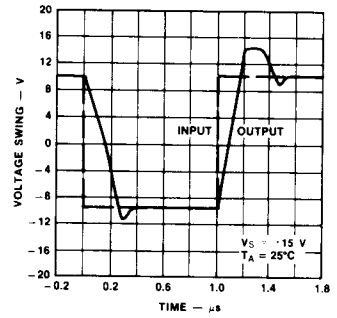

Large Signal Frequency Response

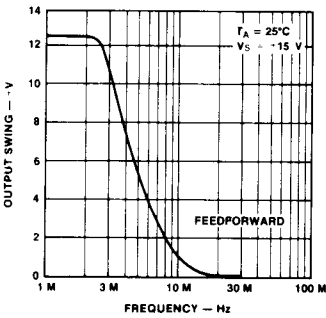

Open Loop Frequency Response

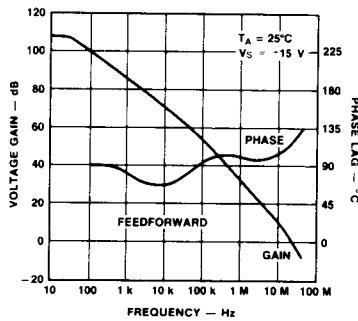

Inverter Pulse Response

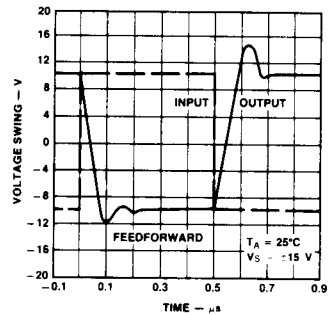

4

Auxiliary Circuits

Feedforward Compensation For Greater Inverting Slew Rate

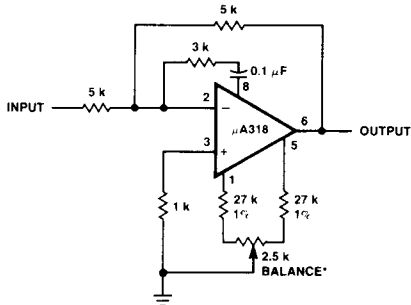

Compensation for Minimum Settling Time

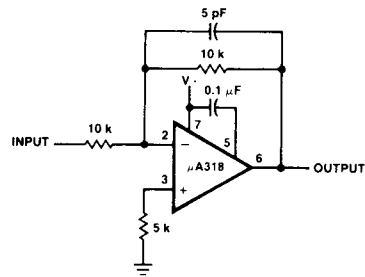

Slew and settling time to 0.1% for a 10 V step change is 800 ns.

Slew rate typically 150 V/μs.
Balance circuit necessary for increased slew.

Offset Balancing

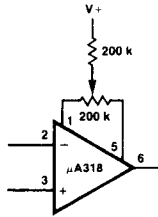

Isolating Large Capacitive Loads

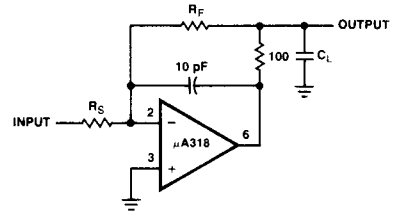

Overcompensation

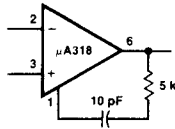

Typical Applications

Fast Voltage Follower

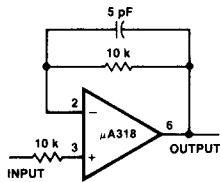

Wein Bridge Sine Wave Oscillator

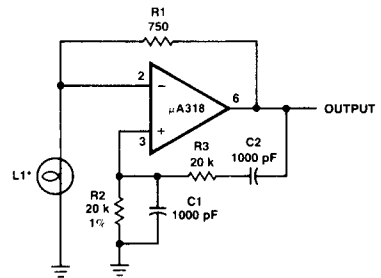

Fast Summing Amplifier

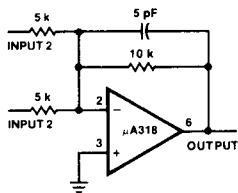

$L1 = 10 \text{ V} \cdot 14 \text{ mA bulb ELDEMA 1869}$

$R2 = R3$

$C1 = C2$

$$f = \frac{1}{2\pi R2 C1}$$

Differential Amplifier

