

National Semiconductor is now part of
Texas Instruments.

Search <http://www.ti.com/> for the latest technical
information and details on our current products and services.

LP2967

Dual Micropower 150 mA Low-Dropout Regulator in micro SMD Package

General Description

The LP2967 is a 150 mA, dual fixed-output voltage regulator designed to provide ultra low-dropout and low noise in battery powered applications.

Using an optimized VIP (Vertically Integrated PNP) process, the LP2967 delivers unequalled performance in all specifications critical to battery powered designs:

Dropout Voltage: Typically 240 mV at 150 mA load, and 6 mV at 1 mA load for each output.

Ground Pin Current: Typically 1 mA at 150 mA load, and 200 μ A at 1 mA load for each output.

Enhanced Stability: The LP2967 is stable with output capacitor ESR as low as 5 m Ω , which allows the use of ceramic capacitors on the output.

Sleep Mode: Less than 2 μ A quiescent current when SD pins are pulled low.

Smallest Possible Size: micro SMD package uses absolute minimum board space.

Precision Output: 1.25% tolerance.

Low Noise: By adding a 100 nF bypass capacitor, output noise can be reduced to 30 μ V (typical).

Multiple voltage options, from 1.8V to 5.0V, are available. Consult factory for custom voltages.

Features

- Ultra low drop-out voltage
- Guaranteed 150mA output current, 300 mA peak
- Smallest possible size (micro SMD package)
- Requires minimum external components
- Stable with 2.2 μ F tantalum or ceramic capacitor
- Output voltage accuracy \pm 1%
- < 2 μ A quiescent current when shut down
- Wide supply voltage range (16V max.)
- Low Z_{OUT} : 0.3 Ω typical (10 Hz to 1 MHz)
- Over temperature/over current protection
- -40°C to +125°C junction temperature range
- Custom voltages available

Applications

- Cellular Phone
- Palmtop/Laptop Computer
- Personal Digital Assistance (PDA)
- Camcorder, Personal Stereo and Camera

Block Diagram

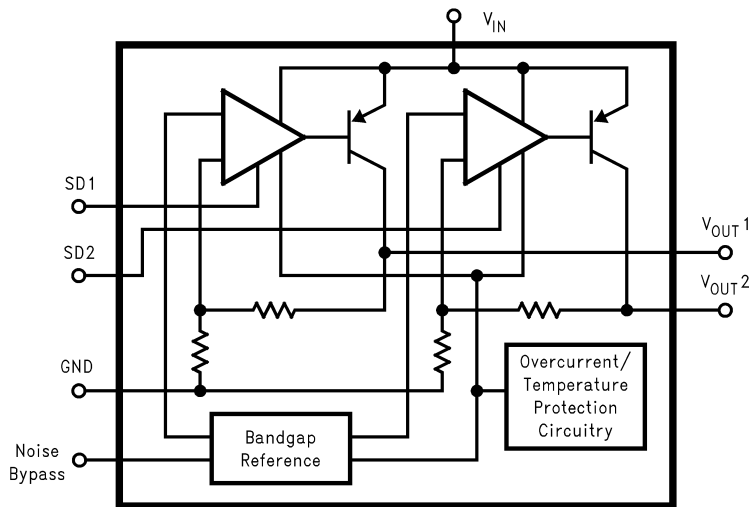

10114201

Basic Application Circuit

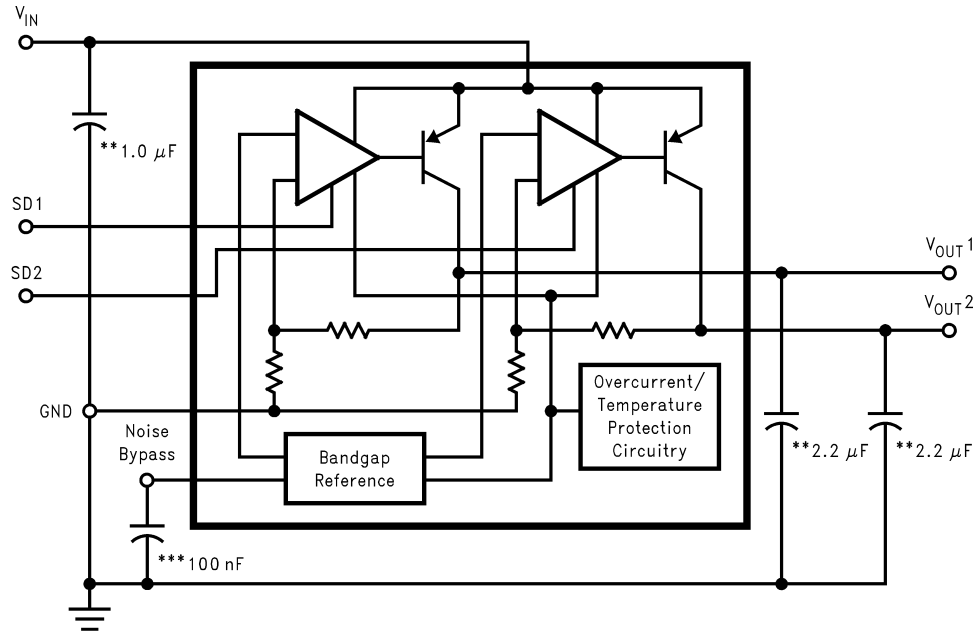

10114202

*SD1 and SD2 must be actively terminated. Tie them to V_{IN} if their functions are not needed.

**Minimum capacitance are shown to ensure stability (may be increased without limit).

*** Reduces output noise (may be omitted if application is not noise critical). Use ceramic or film type with very low leakage current.

Ordering Information

Output Voltage (V)		Grade	Order Information	Package Marking	Supplied As
V_{OUT1}	V_{OUT2}				
For MSOP Package					
2.5	2.8	STD	LP2967IMM-2528	LCAB	1000 Units Tape and Reel
2.5	2.8	STD	LP2967IMMX-2528	LCAB	3000 Units Tape and Reel
2.5	3.3	STD	LP2967IMM-2533	LCBB	1000 Units Tape and Reel
2.5	3.3	STD	LP2967IMMX-2533	LCBB	3000 Units Tape and Reel
2.6	2.6	STD	LP2967IMM-2626	LCLB	1000 Units Tape and Reel
2.6	2.6	STD	LP2967IMMX-2626	LCLB	3000 Units Tape and Reel
2.8	2.8	STD	LP2967IMM-2828	LAQB	1000 Units Tape and Reel
2.8	2.8	STD	LP2967IMMX-2828	LAQB	3000 Units Tape and Reel
2.8	3.3	STD	LP2967IMM-2833	LCCB	1000 Units Tape and Reel
2.8	3.3	STD	LP2967IMMX-2833	LCCB	3000 Units Tape and Reel
For 8-Bump micro SMD Package (BPA08)					
1.8	2.5	STD	LP2967IBP-1825	L0P	1000 Units Tape and Reel
1.8	2.5	STD	LP2967IBPX-1825	L0P	3500 Units Tape and Reel
1.8	3.3	STD	LP2967IBP-1833	L0R	1000 Units Tape and Reel
1.8	3.3	STD	LP2967IBPX-1833	L0R	3500 Units Tape and Reel
2.5	2.8	STD	LP2967IBP-2528	CA	1000 Units Tape and Reel
2.5	2.8	STD	LP2967IBPX-2528	CA	3500 Units Tape and Reel
2.5	3.3	STD	LP2967IBP-2533	CB	1000 Units Tape and Reel
2.5	3.3	STD	LP2967IBPX-2533	CB	3500 Units Tape and Reel
2.6	2.6	STD	LP2967IBP-2626	CL	1000 Units Tape and Reel
2.6	2.6	STD	LP2967IBPX-2626	CL	3500 Units Tape and Reel
2.8	2.8	STD	LP2967IBP-2828	AQ	1000 Units Tape and Reel
2.8	2.8	STD	LP2967IBPX-2828	AQ	3500 Units Tape and Reel

Ordering Information (Continued)

Output Voltage (V)		Grade	Order Information	Package Marking	Supplied As
V _{OUT1}	V _{OUT2}				
2.8	3.3	STD	LP2967IBP-2833	CC	1000 Units Tape and Reel
2.8	3.3	STD	LP2967IBPX-2833	CC	3500 Units Tape and Reel
For 8-Bump micro SMD Package (TPA08)					
1.8	2.5	STD	LP2967ITP-1825	L07	1000 Units Tape and Reel
1.8	2.5	STD	LP2967ITPX-1825	L07	3500 Units Tape and Reel

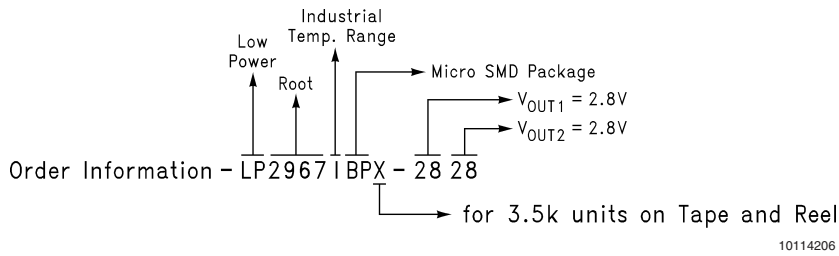
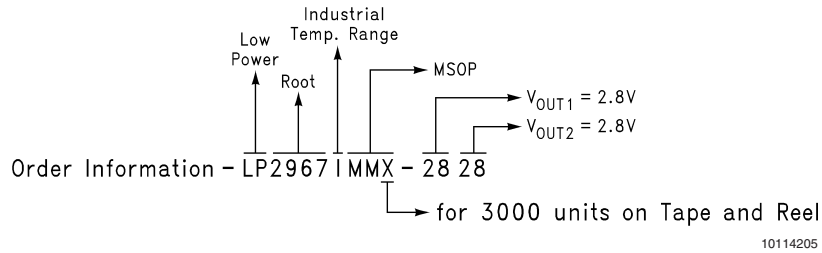

Package Outline and Connection Diagram

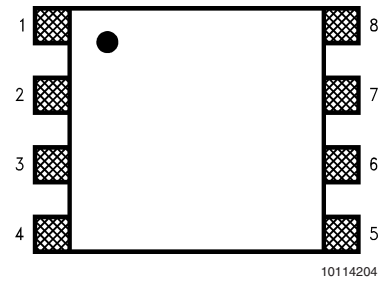
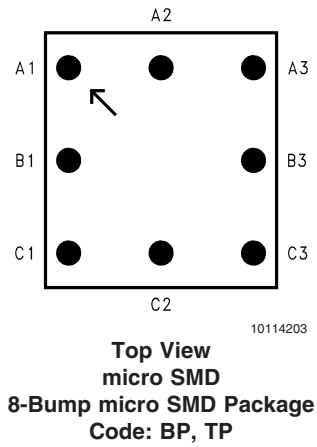

Pin Description

Name	Pin Number		Function
	micro SMD	MSOP	
V_{OUT2}	A1	7	Output voltage of the second LDO
SD2	B1	6	Shutdown input for the second LDO
BYPASS	C1	5	Bypass capacitor for the bandgap
GND	C2	-	Ground Substrate
GND	C3	4	Common Ground
SD1	B3	3	Shutdown input for the first LDO
V_{OUT1}	A3	2	Output voltage of the first LDO
V_{IN}	A2	1, 8	Common input voltage for both LDOs

Absolute Maximum Ratings (Note 1)

If Military/Aerospace specified devices are required, please contact the National Semiconductor Sales Office/Distributors for availability and specifications.

Storage Temperature Range	-65°C to +150°C
Lead Temp. (IR reflow, 10 sec.)	245°C
Pad Temp. (IR reflow, 10 sec.)	245°C
Operating Junction Temp. Range	-40°C to +125°C
Power Dissipation (Note 4)	Internally Limited

ESD Rating (Note 2)	1.5kV
Input Supply Voltage (Survival)	-0.3V to +16V
Input Supply Voltage (Operating)	2.1V to +16V
Shutdown Input Voltage (Survival)	-0.3V to +16V
Output Voltage (Survival) (Note 4)	
I _{OUT} (Survival)	Short Circuit Protected
Input-Output Voltage (Survival), (Note 5)	-0.3V to + 16V

Electrical Characteristics

Limits in standard typeface are for T_j = 25°C, and limits in **boldface type** apply over the full operating junction temperature range. Unless otherwise specified, V_{IN} = V_{O(NOM)} + 1V, I_L = 1mA, C_{IN} = 1μF, C_{OUT} = 4.7μF, V_{ON/OFF} = 1.6V.

Symbol	Parameter	Conditions	Min	Typ	Max	Units
Operating Specifications						
V _O	Output Voltage Tolerance	I _{LOAD} = 1mA 1mA < I _{LOAD} < 150 mA	-1.25 -3.0		1.25 3.0	%
ΔV _O /ΔV _{IN}	Line Regulation	V _{O(NOM)} + 1V < V _{IN} < 16V			0.08	%/V
ΔV _O /ΔI _{LOAD}	Load Regulation	V _{IN} = V _{O(NOM)} + 1V (Note 6) 1mA < I _{LOAD} < 150 mA		-5		mV/V
(V _{IN} - V _O) Min.	Dropout Voltage (Note 7)	I _{LOAD} = 1mA		6	10 15	mV
		I _{LOAD} = 50mA		100	125 180	
		I _{LOAD} = 150mA		240	290 425	
Operating Currents						
I _Q	Quiescent Current	Both Regulators ON I _{LOAD} (1 and 2) = 1mA I _{LOAD} (1 and 2) = 150mA		200 1700	300 5000	μA
		One Regulator OFF I _{LOAD} (1 and 2) = 1mA I _{LOAD} (1 and 2) = 150mA		180 1000	250 2500	
		Both Regulators OFF (Shutdown)			2	
I _{PEAK}	Peak Output Current	V _O < V _{OUT(NOM)} - 5%	200	450		mA
Control Inputs (SD1, SD2)						
V _{IN} (H)	Regulator ON Control Input Voltage		1.6	1.4		V
V _{IN} (L)	Regulator OFF Control Input Voltage	V _O < V _{OUT(NOM)} - 5%		0.8	0.3	V
I _{ON/OFF}	Control Input Current	V _(SD) = 0V V _(SD) = 5V			-2 7	μA
Dynamic Characteristics						
e _n	Output Noise Voltage	C _{BYPASS} = 100nF, 300 to 100kHz		30		μV rms

Electrical Characteristics (Continued)

Limits in standard typeface are for $T_j = 25^\circ\text{C}$, and limits in **boldface type** apply over the full operating junction temperature range. Unless otherwise specified, $V_{IN} = V_{O(NOM)} + 1\text{V}$, $I_L = 1\text{mA}$, $C_{IN} = 1\mu\text{F}$, $C_{OUT} = 4.7\mu\text{F}$, $V_{ON/OFF} = 1.6\text{V}$.

Symbol	Parameter	Conditions	Min	Typ	Max	Units
RR	Ripple Rejection	$C_{BYPASS} = 100\text{nF}$, $V_{IN} = V_{O(NOM)} + 1\text{V} + 100\text{mV}$ p-p square wave (trise and tfall = 100ns) $F = 120\text{Hz}$ $F = 800\text{Hz}$ $F = 1000\text{Hz}$ $F = 1600\text{Hz}$ $F = 10\text{kHz}$ $F = 100\text{kHz}$ $F = 1\text{MHz}$		-52 -54 -56 -58 -50 -47 -70		dB
Xtalk	Crosstalk Rejection	$\Delta I_{LOAD\ 1} = 150\text{ mA}$ at 1kHz rate (15 mA/ μs rise and fall slope) $I_{LOAD\ 2} = 1\text{mA}$ $\Delta V_{OUT\ 2} / \Delta V_{OUT\ 1}$		-100		dB
		$\Delta I_{LOAD\ 2} = 150\text{ mA}$ at 1kHz rate (15 mA/ μs rise and fall slope) $I_{LOAD\ 1} = 1\text{mA}$ $\Delta V_{OUT\ 2} / \Delta V_{OUT\ 1}$		-100		

Note 1: Absolute maximum ratings indicate limits beyond which damage to the device may occur. Electrical specifications do not apply when operating the device beyond its rated operating conditions.

Note 2: Rating is for the human body mode, a 100pF capacitor discharged through a 1.5k Ω resistor into each pin.

Note 3: The maximum allowable power dissipation is calculated by using $P_{DMAX} = (T_{JMAX} - T_A) / \theta_{JA}$, where T_{JMAX} is the maximum junction temperature, T_A is the ambient temperature, and θ_{JA} is the junction-to-ambient thermal resistance of the specified package. Therefore, the maximum power dissipation must be derated at elevated temperatures and is limited by T_{JMAX} , θ_{JA} and A .

Note 4: If used in a dual-supply system where the regulator load is returned to a negative supply, the LP2967 output must be diode-clamped to ground.

Note 5: The output PNP structure contains a diode between the V_{IN} and V_{OUT} terminals that is normally reverse-biased. Reversing the polarity from V_{IN} and V_{OUT} will turn on this diode.

Note 6: Load regulation excursion over temperature is included in Output Voltage Tolerance.

Note 7: The dropout voltage of a regulator is defined as the minimum input-to-output differential required to stay within 100mV of the output voltage measured with a 1V differential.

Typical Performance Characteristics

Unless otherwise specified: $C_{IN} = 1\mu F$, $C_{OUT} = 4.7\mu F$, $V_{ON/OFF} = 1.6V$, $I_L = 1mA$, $T_A = 25^\circ C$.

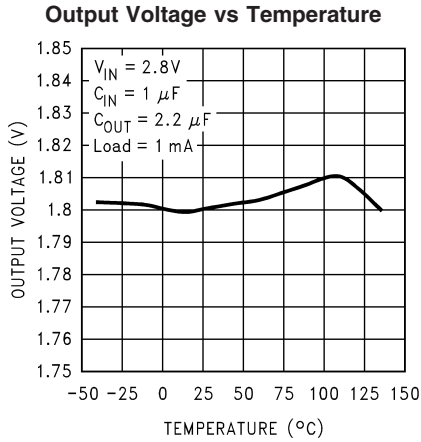

10114255

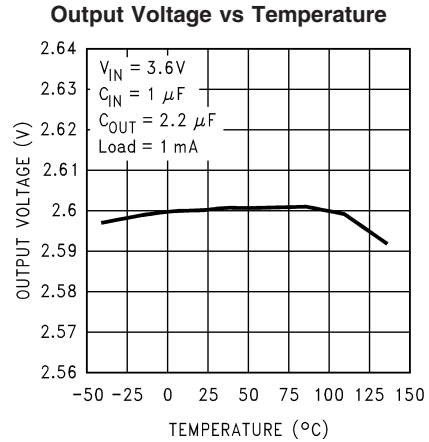

10114256

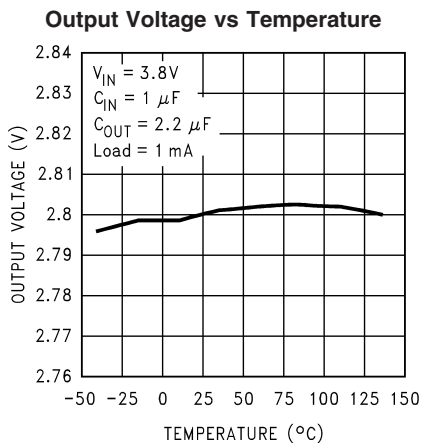

10114257

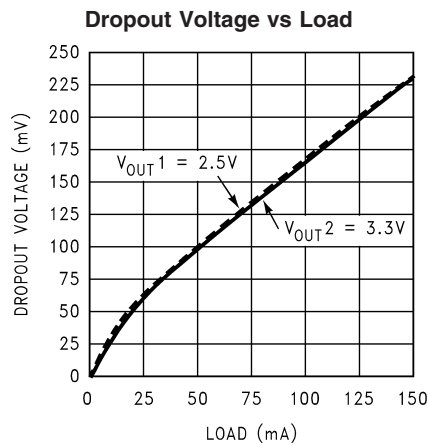

10114216

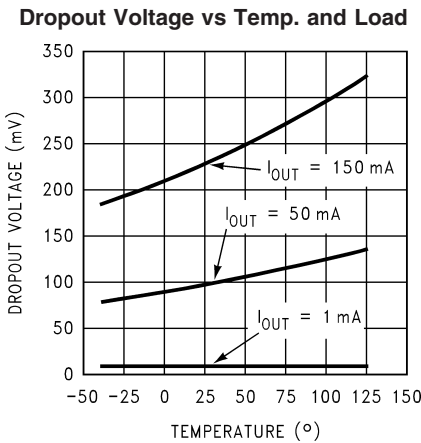

10114217

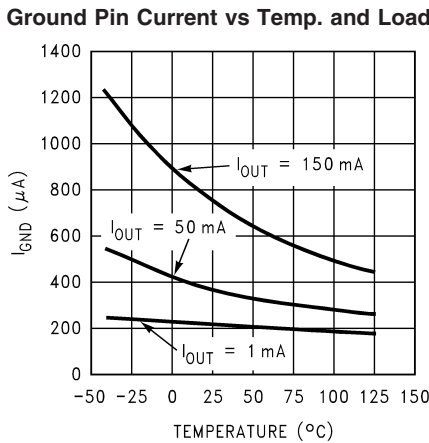

10114218

Typical Performance Characteristics Unless otherwise specified: $C_{IN} = 1\mu F$, $C_{OUT} = 4.7\mu F$, $V_{ON/OFF} = 1.6V$, $I_L = 1mA$, $T_A = 25^\circ C$. (Continued)

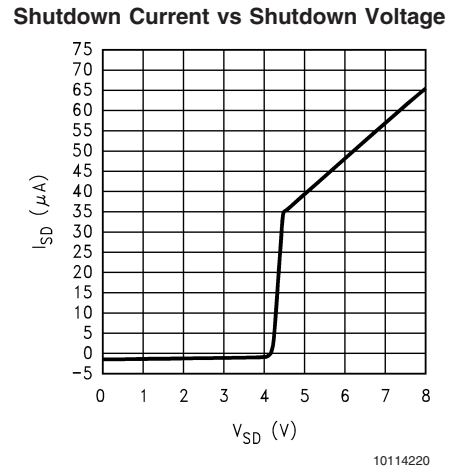
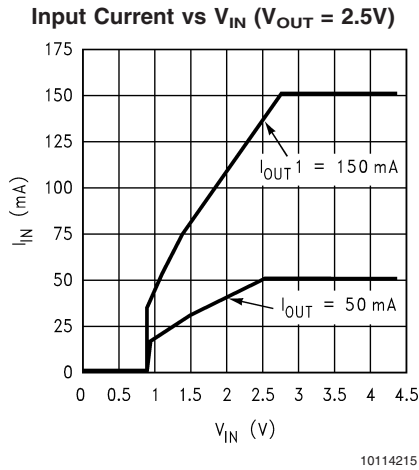
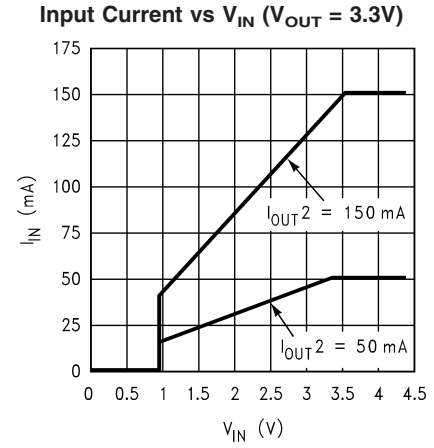
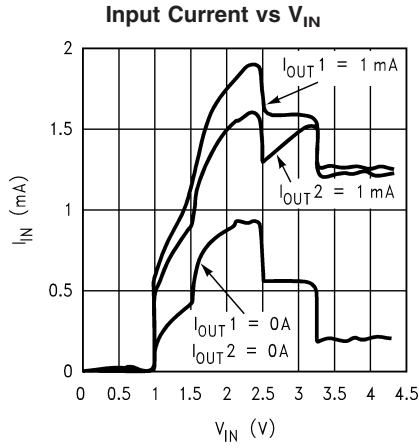
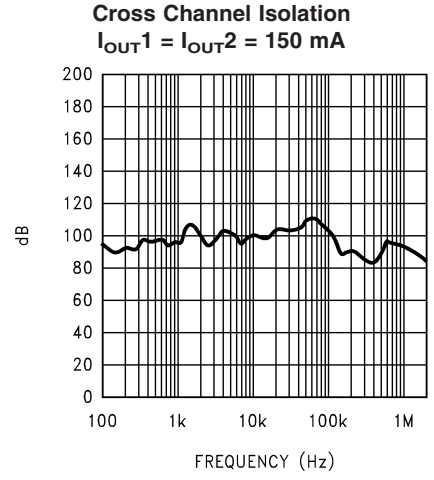
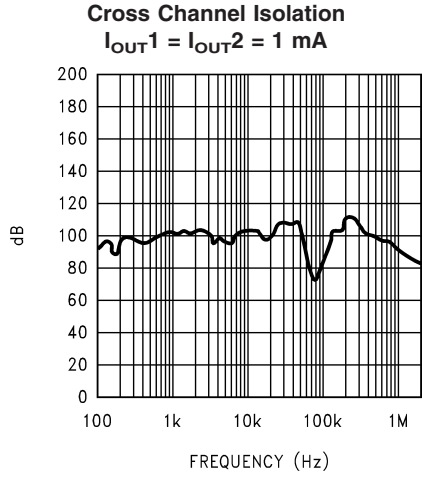

Typical Performance Characteristics Unless otherwise specified: $C_{IN} = 1\mu F$, $C_{OUT} = 4.7\mu F$, $V_{ON/OFF} = 1.6V$, $I_L = 1mA$, $T_A = 25^\circ C$. (Continued)

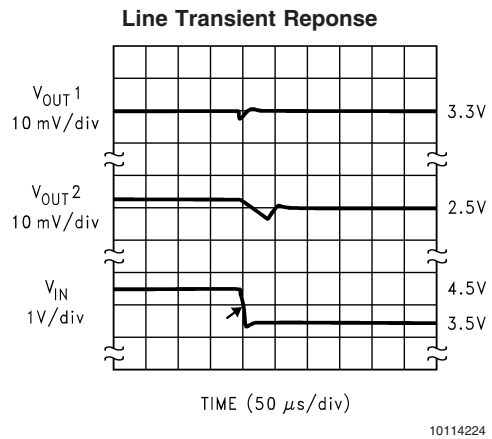
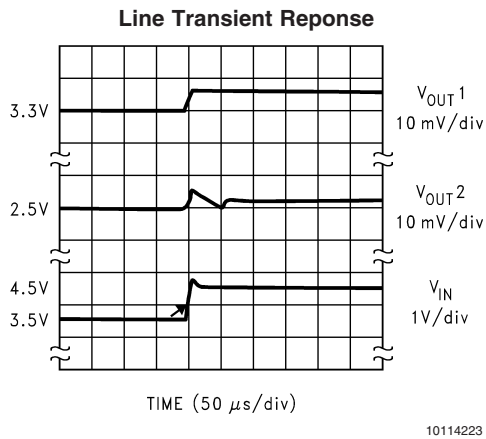
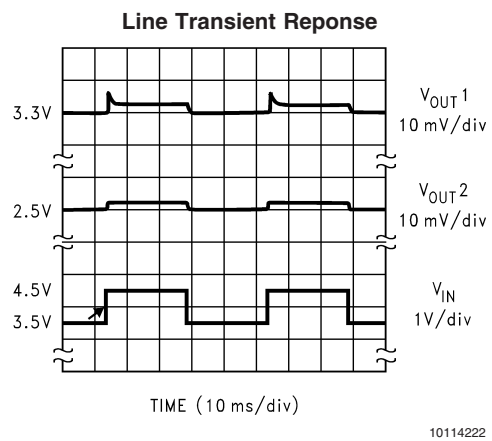
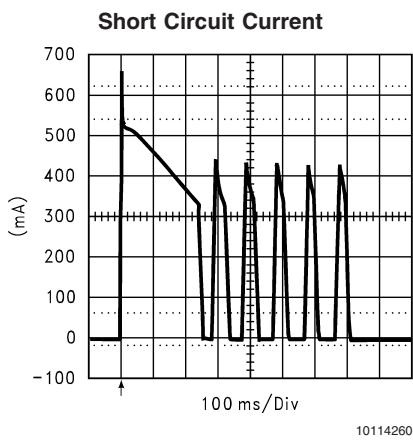
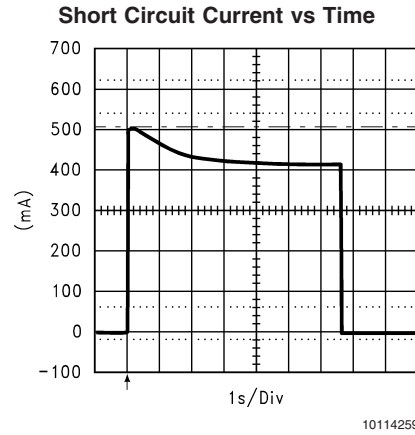
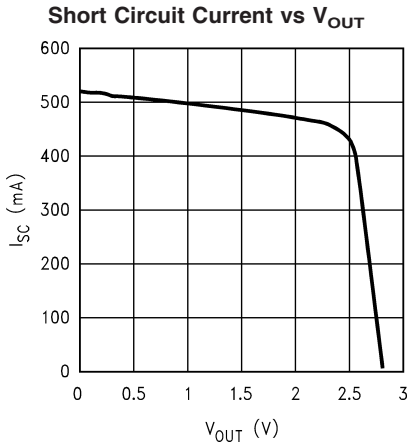

Typical Performance Characteristics Unless otherwise specified: $C_{IN} = 1\mu F$, $C_{OUT} = 4.7\mu F$, $V_{ON/OFF} = 1.6V$, $I_L = 1mA$, $T_A = 25^\circ C$. (Continued)

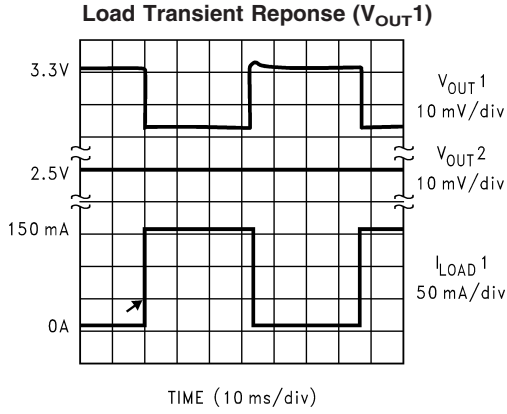

10114231

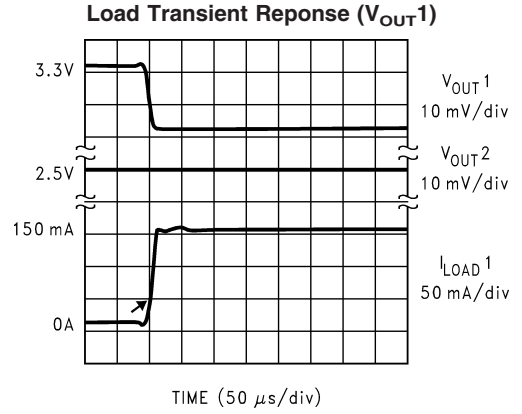

10114232

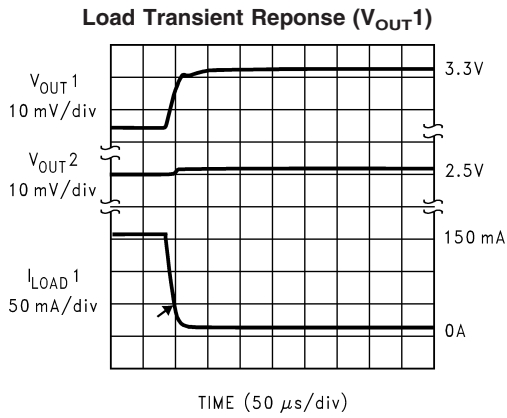

10114233

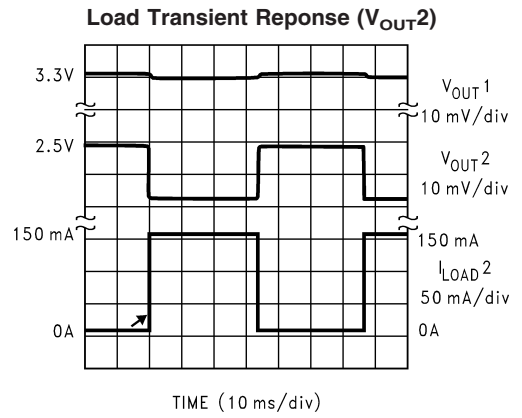

10114234

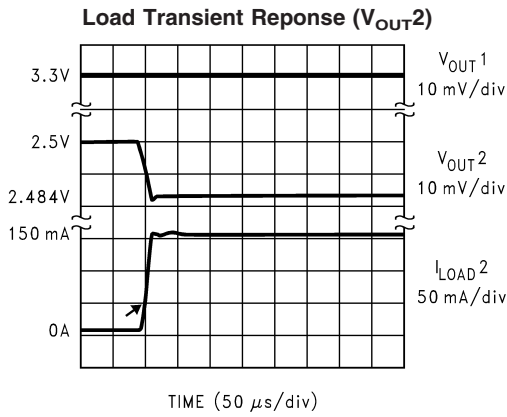

10114235

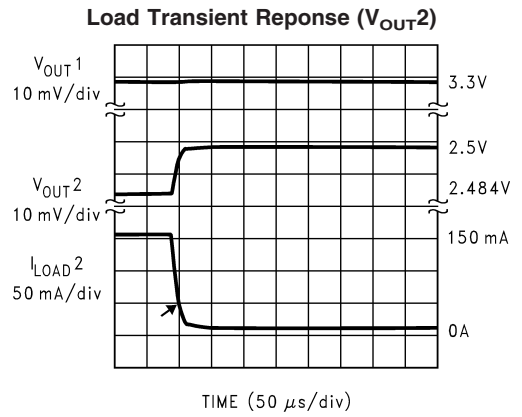

10114236

Typical Performance Characteristics Unless otherwise specified: $C_{IN} = 1\mu F$, $C_{OUT} = 4.7\mu F$, $V_{ON/OFF} = 1.6V$, $I_L = 1mA$, $T_A = 25^\circ C$. (Continued)

LP2967-2.5V Turn-On Time (2nd Output OFF)

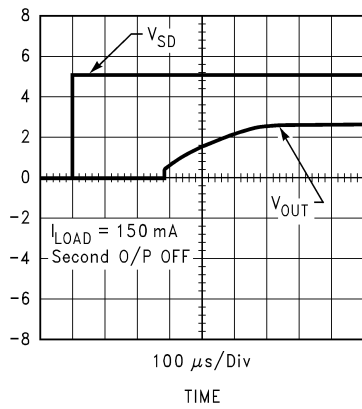

10114240

LP2967-2.5V Turn-On Time (2nd Output ON)

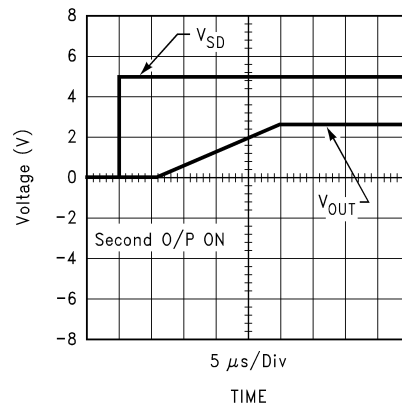

10114241

Output Impedance vs Frequency

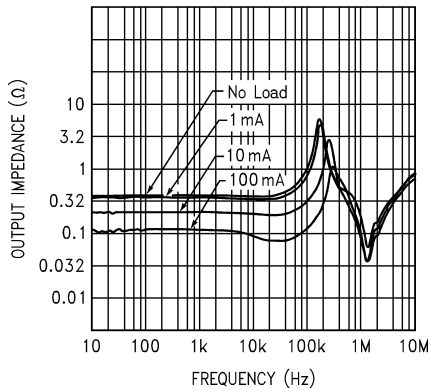

10114248

Ripple Rejection vs Frequency

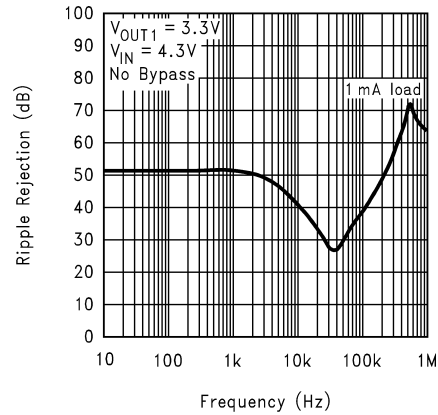

10114249

Ripple Rejection vs Frequency

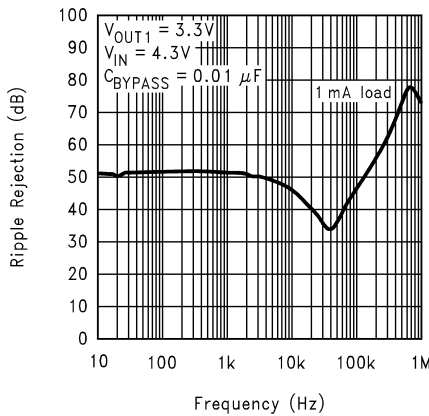

10114250

Ripple Rejection vs Frequency

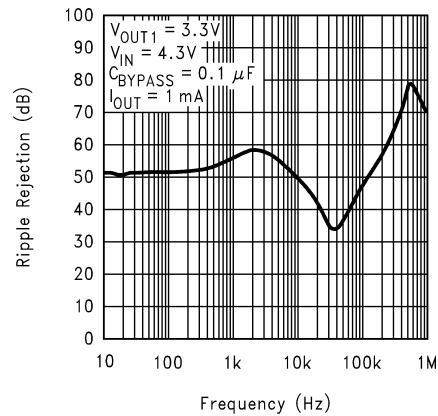

10114251

Typical Performance Characteristics Unless otherwise specified: $C_{IN} = 1\mu F$, $C_{OUT} = 4.7\mu F$, $V_{ON/OFF} = 1.6V$, $I_L = 1mA$, $T_A = 25^\circ C$. (Continued)

Ripple Rejection vs Frequency

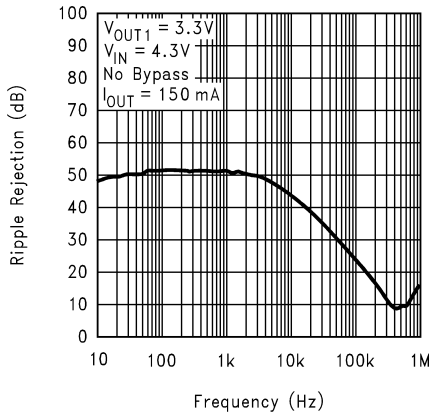

10114252

Ripple Rejection vs Frequency

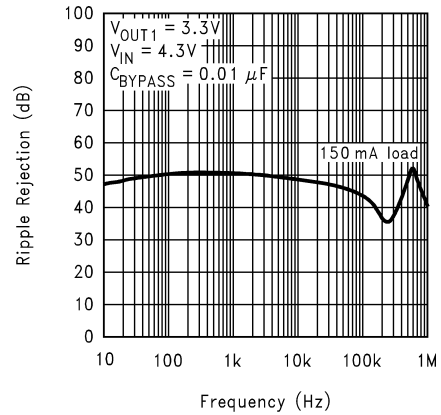

10114253

Ripple Rejection vs Frequency

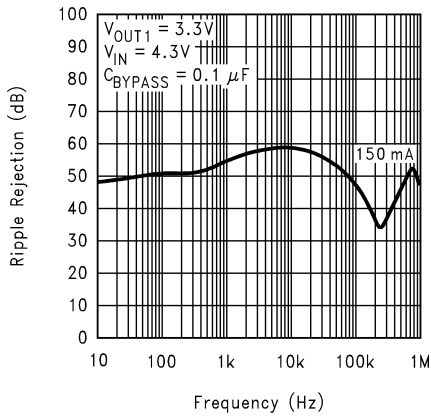

10114254

Output Noise Density

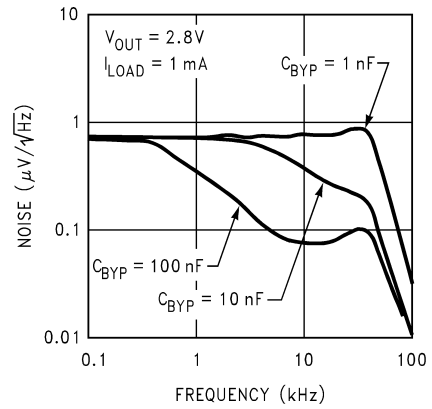

10114262

Output Noise Density

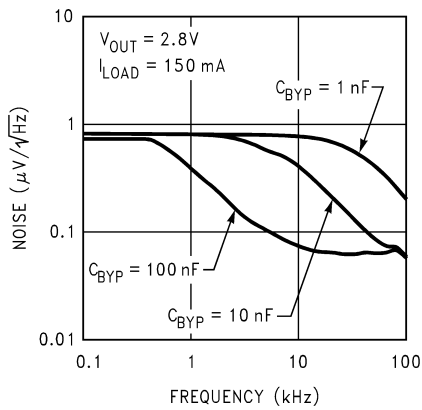

10114261

Application Hints

EXTERNAL CAPACITORS

The LP2967 low dropout regulator requires two external capacitors, C_{IN} and C_{OUT} to assure the device's output stability. C_{BYPASS} may be used to reduce output noise. The capacitors must be correctly selected with respect to capacitance values for all three capacitors and ESR value for C_{OUT} .

Input Capacitor

An input capacitor with a minimum capacitance value of $1\mu F$ is required between the LP2967 input and ground (the amount of capacitance may be increased without limit). This capacitor must be located a distance of not more than 0.5 inches from the input pin and returned to a clean analog ground. Any good quality ceramic or tantalum may be used for this capacitor.

Output Capacitor

The output capacitor must meet the requirement for minimum capacitance value of $2.2\mu F$ and also have an appropriate ESR (equivalent series resistance) value. The LP2967 is actually designed to work with ceramic or tantalum output capacitors, utilizing circuitry which allows the regulator to be stable with an output capacitor whose ESR is as low as $4\text{ m}\Omega$. It may also be possible to use a film capacitor at the output, but this type is not as attractive for reasons of size and cost.

Important: The output capacitor must maintain its ESR in the stable region over the full operating temperature range of the application to assure stability. The minimum required amount of output capacitance is $2.2\mu F$. Output capacitor size can be increased without limit. It is important to remember that capacitor tolerance and variation with temperature must be taken into consideration when selecting an output capacitor so that the minimum required amount of output capacitance is provided over the full operating temperature range.

LP2967-3.3V Region of Stability with $10\mu F C_{OUT}$

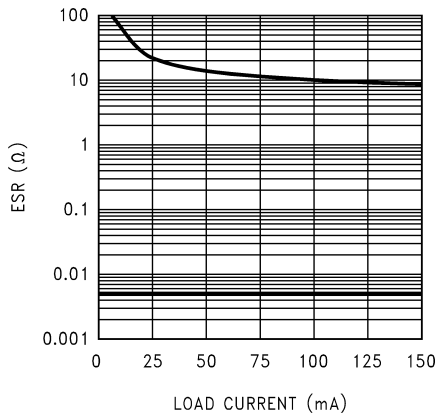

10114208

LP2967-3.3V Region of Stability with $4.7\mu F C_{OUT}$

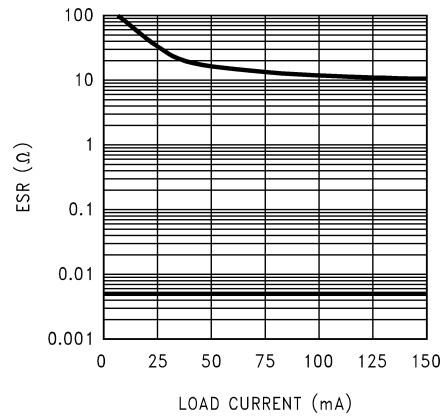

10114207

LP2967-2.5V Region Of Stability with $10\mu F C_{OUT}$

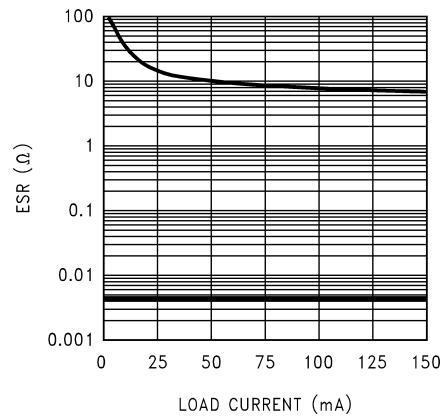

10114209

LP2967-2.5V Region Of Stability with $4.7\mu F C_{OUT}$

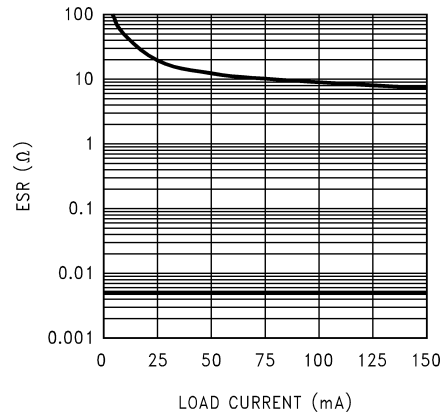

10114210

Application Hints (Continued)

LP2967-2.5V Region Of Stability with 2.2 μF C_{OUT}

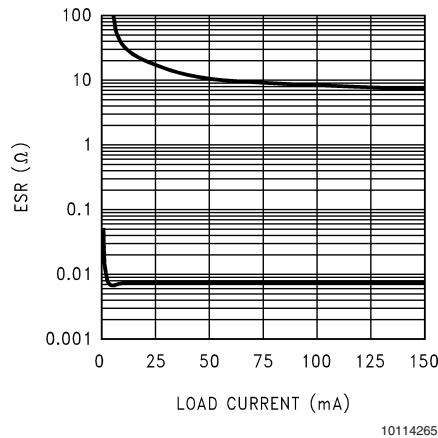

No-Load Operation

If a 2.2 μF output capacitor is used, the minimum stable ESR value rises to about 0.5 Ω at load currents below 1 mA. If the minimum output load is < 1 mA (with $C_{\text{OUT}} = 2.2 \mu\text{F}$), a Tantalum output capacitor should be used (the ESR of a ceramic will be too low). It should be noted that if a 4.7 μF (or larger) output capacitor is used, the part is fully stable with either Tantalum or ceramic from no load to full load output current.

Bypass Capacitor

Connecting a 10 nF capacitor to the Bypass pin significantly reduces noise on the regulator output. It should be noted that the capacitor is connected directly to a high impedance circuit in the bandgap reference. Because this circuit has only a few microamperes flowing into it, any significant loading on this node will cause a change in the regulated output voltage. For this reason, DC leakage current through the noise bypass capacitor must never exceed 100 nA, and should be kept as low as possible for best output voltage accuracy. The types of capacitors best suited for the noise bypass capacitor are ceramic and film capacitors. High quality ceramic capacitors with either NPO or COG dielectric typically have very low leakage. 10 nF polypropylene and polycarbonate film capacitors are available in small surface mount packages and typically have extremely low leakage current.

CAPACITOR CHARACTERISTICS

Ceramic

Ceramic capacitors have the lowest ESR values, which make them best for eliminating high frequency noise. The outputs of LP2967 require a minimum of 2.2 μF of capacitance. The ESR of a typical 2.2 μF ceramic capacitor is in the range of 4 m Ω to 20 m Ω , which easily meets the ESR limits required for stability by the LP2967. One disadvantage of

ceramic capacitors is that their capacitance can vary with temperature. Most large value ceramic capacitors are manufactured with the Z5U or Y5V temperature characteristic, which results in the capacitance dropping by more than 50% as the temperature goes from 25°C to 85°C. This could cause problems if a 2.2 μF capacitor were used on the output since it will drop down to approximately 1 μF at high ambient temperatures. This could cause the LP2967 to oscillate. If Z5U or Y5V capacitors are used on the output, a minimum capacitance value of 4.7 μF must be used.

A better choice for temperature coefficient in ceramic capacitors is X7R or X5R which hold the capacitance to within $\pm 15\%$ over the full temperature range. Unfortunately, the larger values of capacitance are not offered by all manufacturers in the X7R dielectric.

Tantalum

For the LP2967, tantalum capacitors are less desirable than ceramic for use as output capacitors because they are typically more expensive when comparing equivalent capacitance and voltage ratings in the 2.2 μF to 4.7 μF range of capacitance. Tantalum capacitors have good temperature stability: a 4.7 μF was tested and showed a 10% decline in capacitance as the temperature was decreased from +125°C to -40°C while the ESR increased by about 2:1 over the same range of temperatures. This increase in ESR at lower temperatures can cause oscillations when marginal quality capacitors are used and the upper limit for ESR value is exceeded.

Aluminum

The large physical size of aluminum electrolytic capacitors make them unattractive for use with the LP2967. Their ESR characteristics are also not well suited to the requirements of LDO regulators. The ESR of an aluminum electrolytic is higher than that of a tantalum, and it also varies greatly with temperature. A typical aluminum electrolytic can exhibit an ESR increase of 50X when going from 20°C to -40°C. Also, some aluminum electrolytic capacitors can not be used below -25°C because the electrolyte will freeze.

SHUTDOWN OPERATION

The two LDO regulators in the LP2967 have independent shutdown pins. A low logic level signal at either of the shutdown pins SD1 or SD2 will turn off the corresponding regulator output $V_{\text{OUT}1}$ or $V_{\text{OUT}2}$. Pins SD1 and SD2 must be terminated by tying them to V_{IN} for a proper operation when the shutdown function is not required.

REVERSE CURRENT PATH

The internal power transistor in the LP2967 has an inherent parasitic diode. During normal operation, the input voltage is higher than the output voltage and the parasitic diode is reverse biased. However, if the output is pulled above the input in an application, then current flows from the output to the input if the parasitic diode gets forward biased. The output can be pulled above the input as long as the current in the parasitic diode is limited to 150mA.

Application Hints (Continued)

MAXIMUM POWER DISSAIPATION CAPABILITY

Each output pin the LP2967 can deliver a current of up to 150mA over the full operating junction temperature range. However, the maximum output current must be derated at higher ambient temperature to ensure the junction temperature does not exceed 125°C. Under all possible conditions, the junction temperatures must be within the range specified under operating conditions. The LP2967 is available in MSOP-8 package and 8-bump micro SMD. The junction to

ambient temperature coefficient (θ_{JA}) for an MSOP-8 package is 235°C/W and the 8-bump micro SMD with minimum copper area is 220°C/W. The total power dissipation of the device is given by:

$$PD = (V_{IN} - V_{OUT1}) I_{OUT1} + (V_{IN} - V_{OUT2}) I_{OUT2}$$

The maximum power dissipation, PDmax, that the device can tolerate can be calculated by using the formula:

$$PD_{max} = (T_{JMAX} - T_A) / \theta_{JA}$$

where T_{JMAX} is the maximum specified junction temperature (125°C), and T_A is the maximum ambient temperature.

Physical Dimensions inches (millimeters) unless otherwise noted

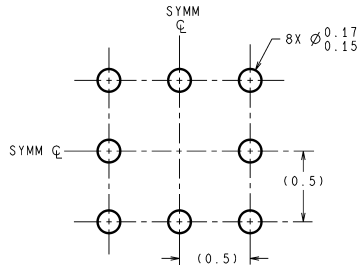

LAND PATTERN RECOMMENDATION

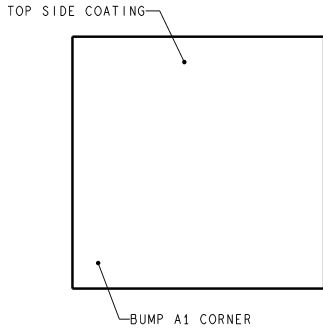

DIMENSIONS ARE IN MILLIMETERS
DIMENSIONS IN () FOR REFERENCE ONLY

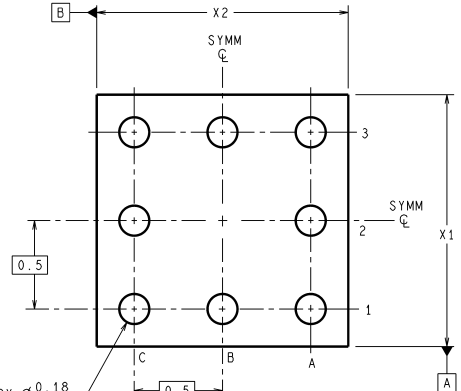
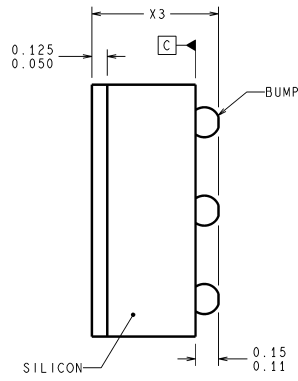

8x \varnothing $\begin{matrix} 0.18 \\ 0.16 \end{matrix}$

\varnothing 0.005 C A B

TPA08XXX (Rev B)

micro SMD Package
NS Package Number TPA08F5A
The dimensions of X1, X2, and X3 are given below:
X1 = 1.412mm
X2 = 1.946mm
X3 = 0.500mm

Physical Dimensions inches (millimeters) unless otherwise noted (Continued)

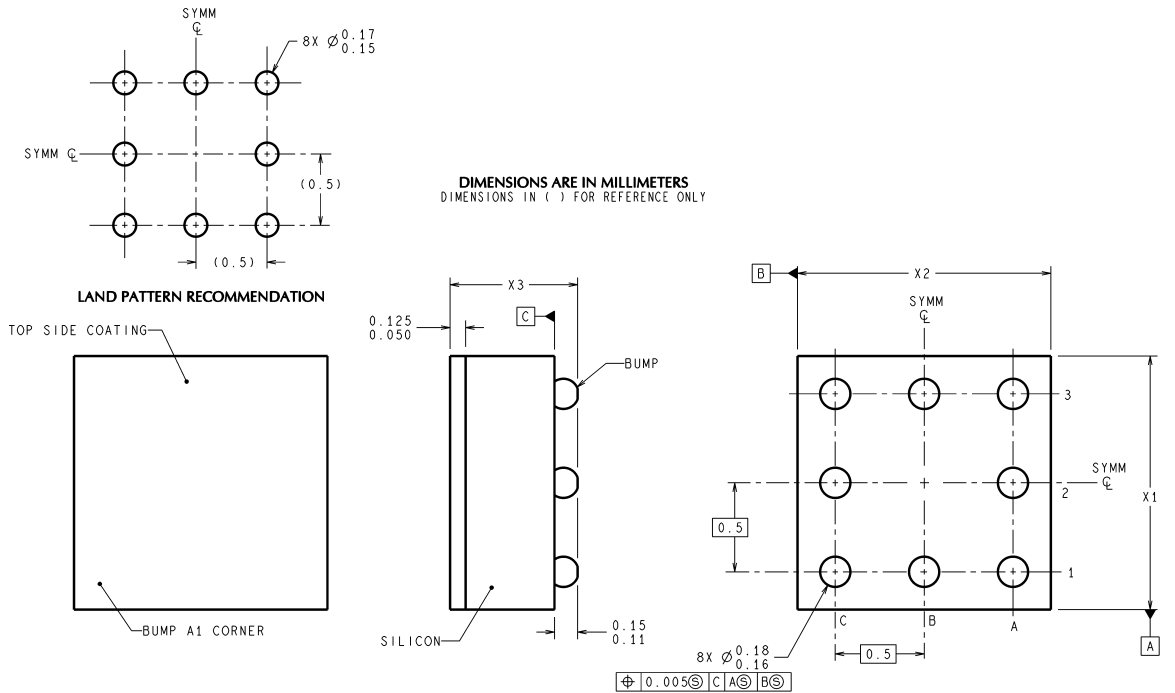

micro SMD Package
NS Package Number BPA08F5B
 The dimensions of X1, X2, and X3 are given below:
X1 = 1.412mm
X2 = 1.946mm
X3 = 0.850mm

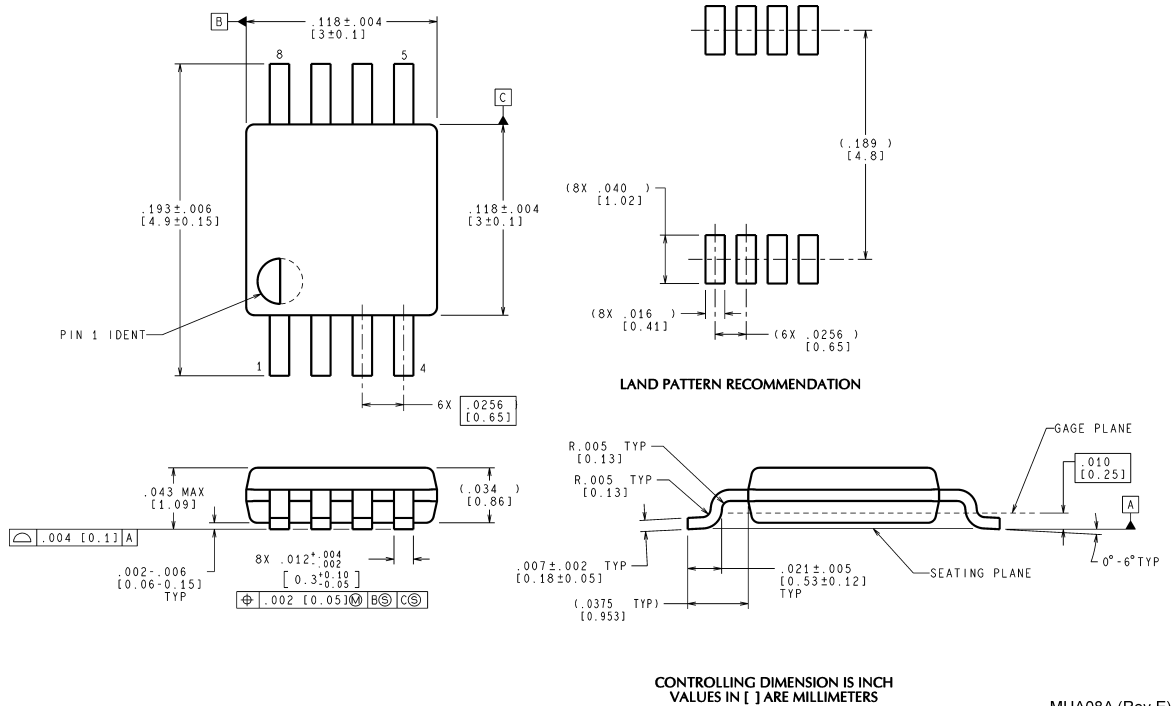

Mini SO-8 Package Type MM
 For Ordering, Refer to Ordering Information Table
NS Package Number MUA08A

Notes

National does not assume any responsibility for use of any circuitry described, no circuit patent licenses are implied and National reserves the right at any time without notice to change said circuitry and specifications.

For the most current product information visit us at www.national.com.

LIFE SUPPORT POLICY

NATIONAL'S PRODUCTS ARE NOT AUTHORIZED FOR USE AS CRITICAL COMPONENTS IN LIFE SUPPORT DEVICES OR SYSTEMS WITHOUT THE EXPRESS WRITTEN APPROVAL OF THE PRESIDENT AND GENERAL COUNSEL OF NATIONAL SEMICONDUCTOR CORPORATION. As used herein:

1. Life support devices or systems are devices or systems which, (a) are intended for surgical implant into the body, or (b) support or sustain life, and whose failure to perform when properly used in accordance with instructions for use provided in the labeling, can be reasonably expected to result in a significant injury to the user.
2. A critical component is any component of a life support device or system whose failure to perform can be reasonably expected to cause the failure of the life support device or system, or to affect its safety or effectiveness.

BANNED SUBSTANCE COMPLIANCE

National Semiconductor manufactures products and uses packing materials that meet the provisions of the Customer Products Stewardship Specification (CSP-9-111C2) and the Banned Substances and Materials of Interest Specification (CSP-9-111S2) and contain no "Banned Substances" as defined in CSP-9-111S2.

Leadfree products are RoHS compliant.



National Semiconductor
Americas Customer
Support Center
Email: new.feedback@nsc.com
Tel: 1-800-272-9959

www.national.com

National Semiconductor
Europe Customer Support Center
Fax: +49 (0) 180-530 85 86
Email: europa.support@nsc.com
Deutsch Tel: +49 (0) 69 9508 6208
English Tel: +44 (0) 870 24 0 2171
Français Tel: +33 (0) 1 41 91 8790

National Semiconductor
Asia Pacific Customer
Support Center
Email: ap.support@nsc.com

National Semiconductor
Japan Customer Support Center
Fax: 81-3-5639-7507
Email: jpn.feedback@nsc.com
Tel: 81-3-5639-7560