

Description

The PESD1CAN is a bi-directional TVS diode array, utilizing leading monolithic silicon technology to provide fast response time and low ESD clamping voltage, making this device an ideal solution for protecting sensitive semiconductor components from damage. The PESD1CAN complies with the IEC 61000-4-2 (ESD) standard with $\pm 15\text{kV}$ air and $\pm 8\text{kV}$ contact discharge. It is assembled into a lead-free SOT-23 package. It is designed to protect components which are connected to data and transmission lines from voltage surges.

Circuit Diagram

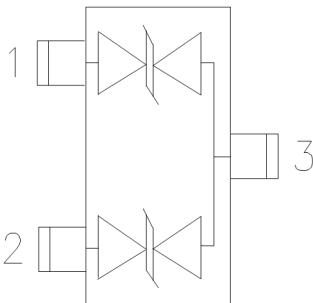

Marking Diagram

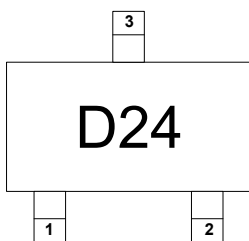

Transparent top view

D24: Device Marking Code

Features

- * 420W peak pulse power (8/20 μs)
- * Protects two bi-directional lines
- * Ultra low leakage: nA level
- * Operating voltage: 24V
- * AEC-Q101 qualified
- * Low clamping voltage
- * Complies with following standards:
 - IEC 61000-4-2 (ESD) immunity test
 - Air discharge: $\pm 30\text{kV}$
 - Contact discharge: $\pm 30\text{kV}$
 - IEC61000-4-4 (EFT) 40A (5/50ns)
 - IEC61000-4-5 (Lightning) 9A (8/20 μs)
- * RoHS Compliant

Applications

- * Cellular Handsets and Accessories
- * Notebooks and Handhelds
- * Portable Instrumentation
- * Set Top Box
- * Industrial Controls
- * Server and Desktop PC

Ordering Information

Part Number	Packaging	Reel Size
PESD1CAN	3000/Tape & Reel	7 inch

Absolute Maximum Ratings ($T_A=25^{\circ}\text{C}$ unless otherwise specified)

Parameter	Symbol	Value	Unit
Peak Pulse Power (8/20 μs)	Ppk	420	W
Peak Pulse Current (8/20 μs)	IPP	9	A
ESD per IEC 61000-4-2 (Air)	VESD	± 30	kV
ESD per IEC 61000-4-2 (Contact)		± 30	
Operating Temperature Range	TJ	-55 to +125	$^{\circ}\text{C}$
Storage Temperature Range	Tstg	-55 to +150	$^{\circ}\text{C}$

Electrical Characteristics ($T_A=25^{\circ}\text{C}$ unless otherwise specified)

Parameter	Symbol	Test Condition	Min	Typ	Max	Unit
Reverse Working Voltage	V_{RWM}				24	V
Breakdown Voltage	V_{BR}	$I_T = 1\text{mA}$	26	28.5	30.5	V
Reverse Leakage Current	I_R	$V_{RWM} = 24\text{V}$			0.5	μA
Clamping Voltage	V_C	$I_{PP} = 1\text{A}$ (8 x 20 μs pulse)		35	40	V
Clamping Voltage	V_C	$I_{PP} = 9\text{A}$ (8 x 20 μs pulse)		45	58	V
Junction Capacitance	C_J	$V_R = 0\text{V}$, $f = 1\text{MHz}$		30	50	pF

Portion Electronics Parameter

Symbol	Parameter
I_T	Test Current
I_{PP}	Maximum Reverse Peak Pulse Current
V_C	Clamping Voltage @ I_C

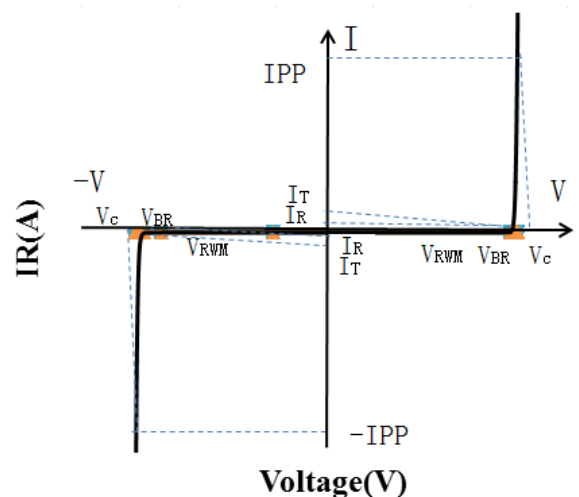



Typical Performance Characteristics ($T_A=25^\circ\text{C}$ unless otherwise Specified)

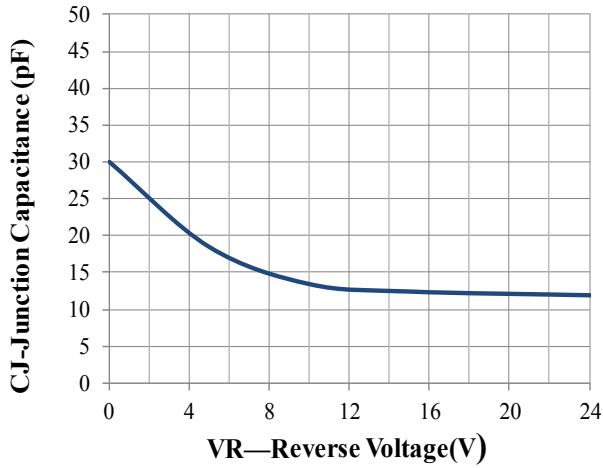

Junction Capacitance vs. Reverse Voltage

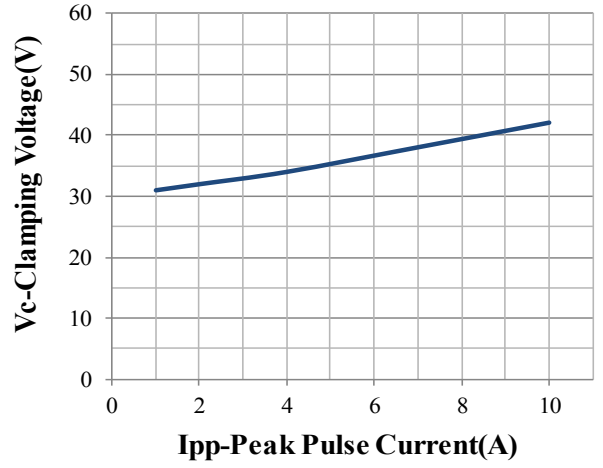

Clamping Voltage vs. Peak Pulse Current

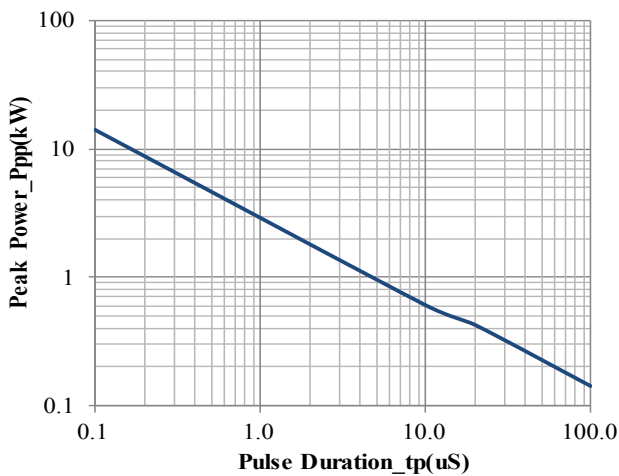

Peak Pulse Power vs. Pulse Time

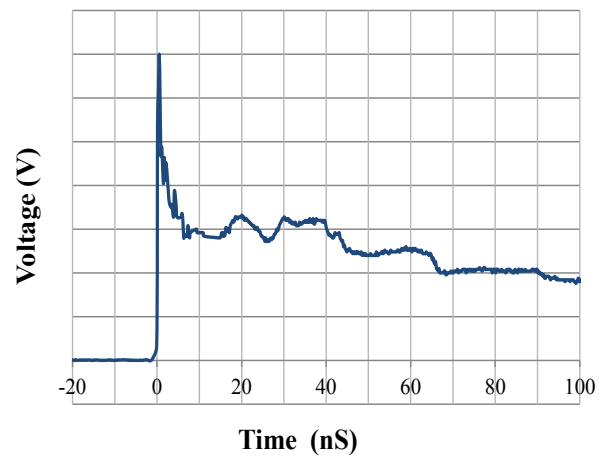

IEC61000-4-2 Pulse Waveform

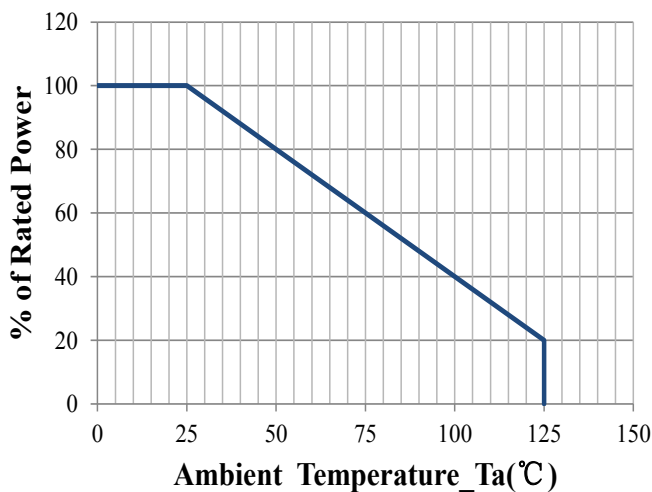

Power Derating Curve

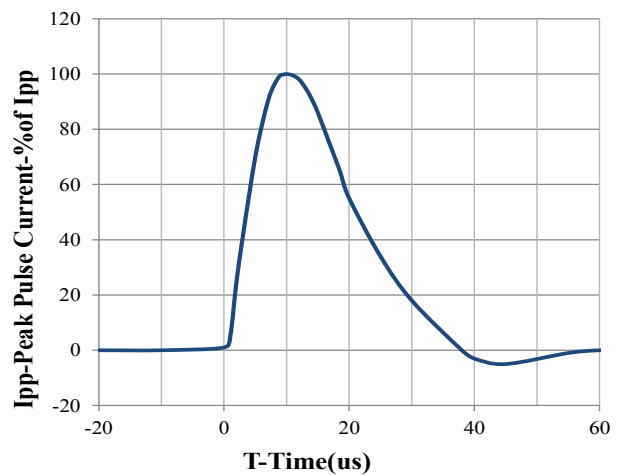

8 X 20us Pulse Waveform

SOT-23 Package Outline Drawing

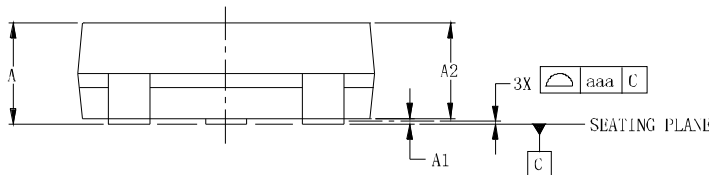
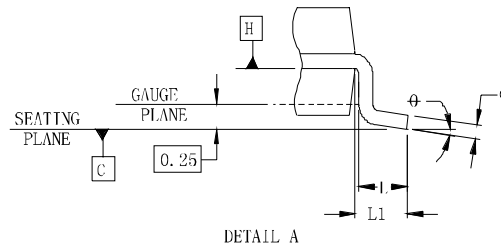
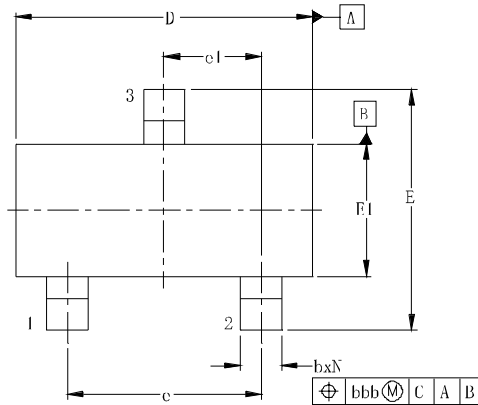

DIM	DIMENSIONS					
	INCHES			MILLIMETERS		
	MTN	NOM	MAX	MTN	NOM	MAX
A	.035	—	.044	0.89	—	1.12
A1	.000	—	.004	0.01	—	0.10
A2	.035	.037	.040	0.88	0.95	1.02
b	.012	—	.020	0.30	—	0.51
c	.003	—	.007	0.08	—	0.18
D	.110	.114	.120	2.80	2.90	3.04
E	.082	.093	.104	2.10	2.37	2.64
E1	.047	.051	.055	1.20	1.30	1.40
e	.075			1.90 BSC		
e1	.037			0.95 BSC		
L	.015	.020	.024	0.40	0.50	0.60
L1	.022			(0.55)		
N	3			3		
θ	0°	—	8°	0°	—	8°
aaa	.001			0.10		
bbb	.008			0.20		

Suggested Land Pattern

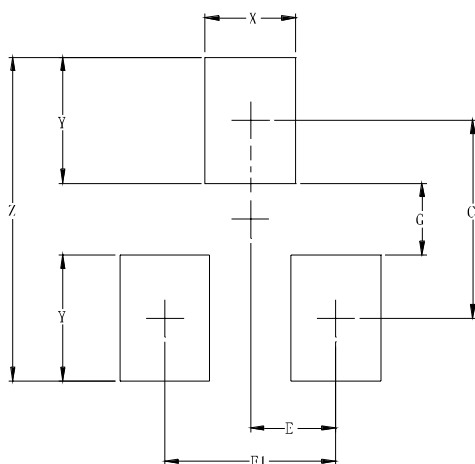

DIM	DIMENSIONS	
	INCHES	MILLIMETERS
C	.087	2.20
E	.037	0.95
E1	.075	1.90
G	.031	0.80
X	.039	1.00
Y	.055	1.40
Z	.141	3.60