

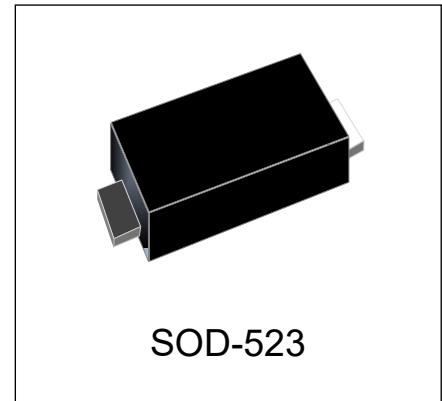

## Features

- Small Body Outline Dimensions
- Low Body Height: 0.024" (0.6 mm) Nom
- 325 Watts peak pulse power ( $t_p = 8/20\mu s$ )
- Protects one I/O or power line
- Replacement for MLV(0603)
- Low clamping voltage
- Working voltage: 5V
- Low leakage current
- Solid-state silicon-avalanche technology



## IEC Compatibility (EN61000-4)

- IEC 61000-4-2 (ESD)  $\pm 30kV$  (air),  $\pm 30kV$  (contact)
- IEC 61000-4-4 (EFT) 40A (5/50ns)
- IEC 61000-4-5 (Lightning) 30A (8/20 $\mu s$ )

## Mechanical Characteristics

- JEDEC SOD-523 package
- Marking : Marking Code
- Packaging : Tape and Reel per EIA 481
- RoHS Compliant

## Applications

- Cellular Handsets & Accessories
- Personal Digital Assistants (PDAs)
- Notebooks & Handhelds
- Digital Cameras
- MP3 players

## Schematic & PIN Configuration

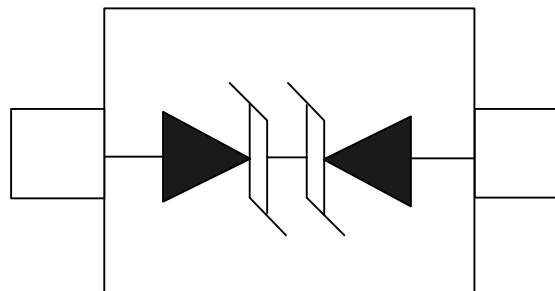

SOD-523 (Top View)

<b>Absolute Maximum Rating</b>			
Rating	Symbol	Value	Units
Peak Pulse Power ( $t_p = 8/20\mu s$ )	$P_{PP}$	325	Watts
Maximum Peak Pulse Current ( $t_p = 8/20\mu s$ )	$I_{PP}$	30	A
Operating Temperature	$T_J$	-55 to + 125	$^{\circ}C$
Storage Temperature	$T_{STG}$	-55 to +150	$^{\circ}C$

### Electrical Parameters (T=25 $^{\circ}C$ )

Symbol	Parameter
$I_{PP}$	Maximum Reverse Peak Pulse Current
$V_C$	Clamping Voltage @ $I_{PP}$
$V_{RWM}$	Working Peak Reverse Voltage
$I_R$	Maximum Reverse Leakage Current @ $V_{RWM}$
$V_{BR}$	Breakdown Voltage @ $I_T$
$I_T$	Test Current

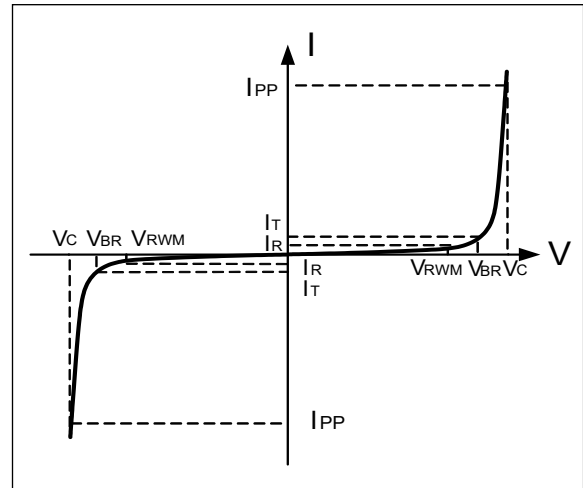

### Electrical Characteristics

<b>PESD5V0U1UB</b>						
Parameter	Symbol	Conditions	Minimum	Typical	Maximum	Units
Reverse Stand-Off Voltage	$V_{RWM}$				5.0	V
Reverse Breakdown Voltage	$V_{BR}$	$I_T = 1mA$	6.0			V
Reverse Leakage Current	$I_R$	$V_{RWM} = 5V, T = 25^{\circ}C$			500	nA
Clamping Voltage	$V_C$	$I_{PP} = 30A, t_p = 8/20\mu s$		9.5	13.0	V
Dynamic Resistance <sup>1,2</sup>	$R_{DYN}$	TLP=0.2/100ns		0.06		$\Omega$
ESD Clamping Voltage <sup>1</sup>	$V_C$	$I_{PP} = 4A, t_p = 0.2/100ns$ (TLP)		7		V
ESD Clamping Voltage <sup>1</sup>	$V_C$	$I_{PP} = 16A, t_p = 0.2/100ns$ (TLP)		7.7		V
Junction Capacitance	$C_j$	$V_R = 0V, f = 1MHz$		80.0	100.0	pF

Notes : 1、TLP Setting :  $t_p = 100ns, t_r = 0.2ns, I_{TLP}$  and  $V_{TLP}$  sample window:  $t_1 = 70ns$  to  $t_2 = 90ns$ .  
 2、Dynamic resistance calculated from  $I_{PP} = 4A$  to  $I_{PP} = 16A$  using "Best Fit".

## Typical Characteristics

Figure 1: Peak Pulse Power Vs Pulse Time

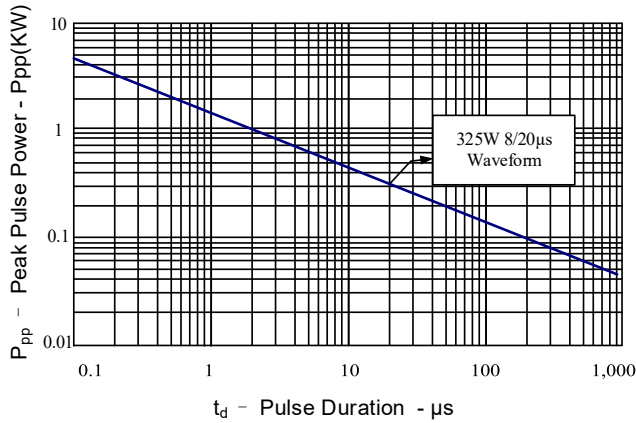

Figure 2: Power Derating Curve

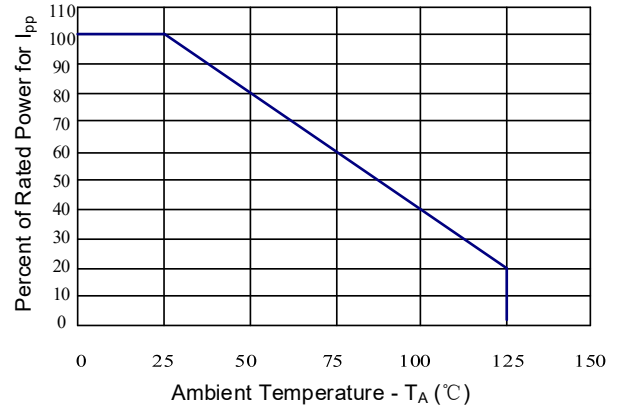

Figure 3: Clamping Voltage vs. Peak Pulse Current

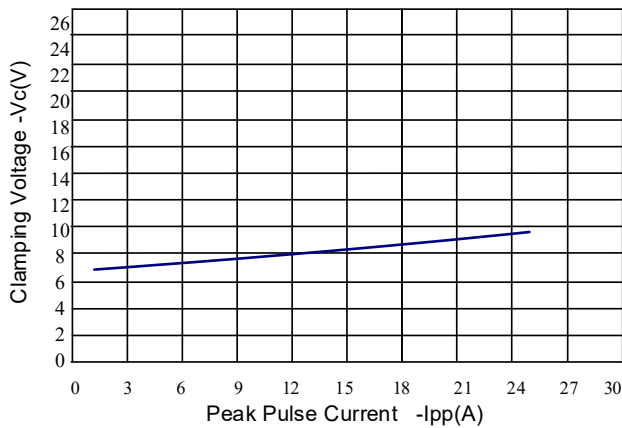

Figure 4: Normalized Junction Capacitance vs. Reverse Voltage

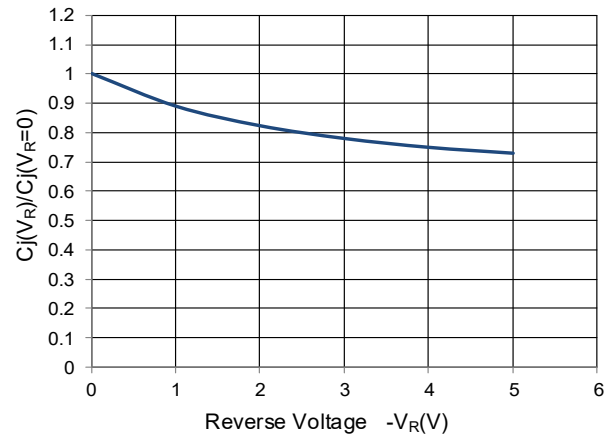

Figure 5: TLP Positive I-V Curve

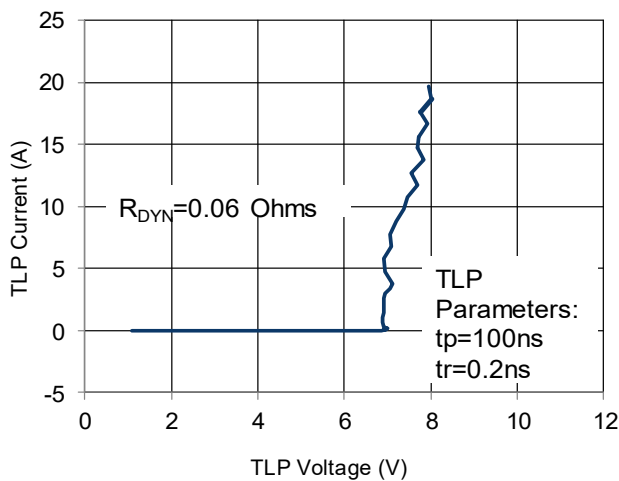
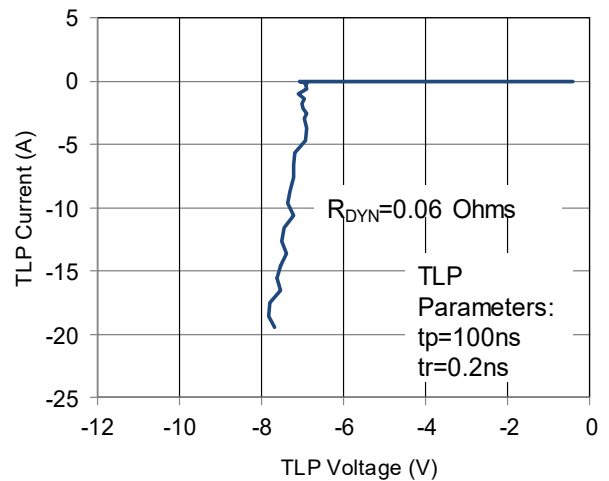

Figure 6: TLP Negative I-V Curve





## Soldering Parameters

Reflow Condition		Pb – Free assembly
Pre Heat	Temperature Min ( $T_{S(min)}$ )	150°C
	Temperature Max ( $T_{S(max)}$ )	200°C
	Time (min to max) ( $t_s$ )	60 – 190 secs
Average ramp up rate (Liquidus Temp) ( $T_L$ ) to peak		5°C/second max
$T_{S(max)}$ to $T_L$ —Ramp-up Rate		5°C/second max
Reflow	Temperature ( $T_L$ ) (Liquidus)	217°C
	Temperature ( $t_L$ )	60 – 150 seconds
Peak Temperature ( $T_P$ )		260+0/-5 °C
Time within actual peak Temperature ( $t_p$ )		20 – 40 seconds
Ramp-down Rate		5°C/second max
Time 25°C to peak Temperature ( $T_P$ )		8 minutes Max.
Do not exceed		280°C

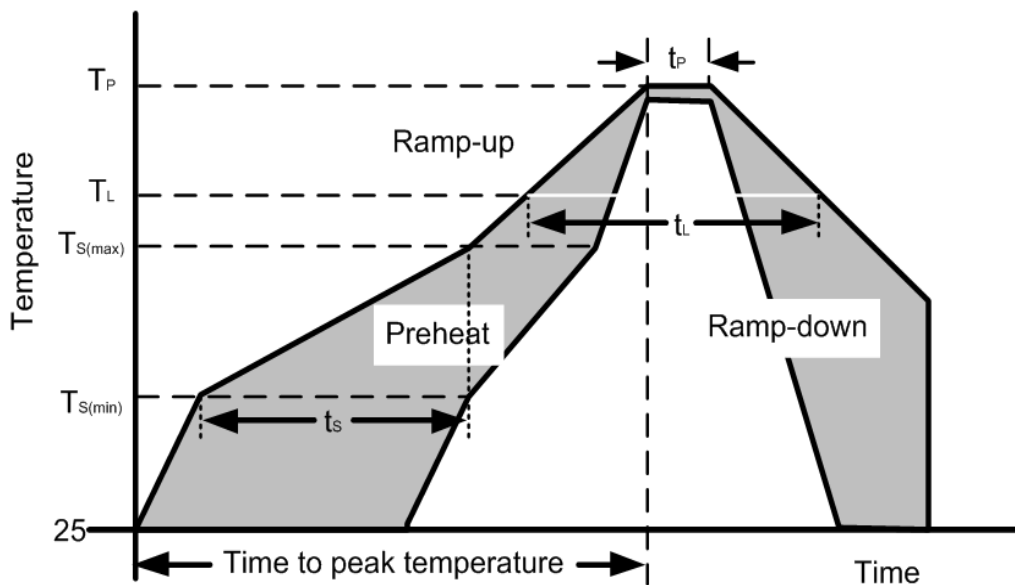



Outline Drawing –SOD-523

PACKAGE OUTLINE		DIMENSIONS																																																		
		<p>SOD-523</p>																																																		
						<table border="1"> <thead> <tr> <th rowspan="2">SYMBOL</th> <th colspan="2">MILLIMETERS</th> <th colspan="2">INCHES</th> </tr> <tr> <th>MIN</th> <th>MAX</th> <th>MIN</th> <th>MAX</th> </tr> </thead> <tbody> <tr> <td>A</td> <td>0.50</td> <td>0.70</td> <td>0.020</td> <td>0.028</td> </tr> <tr> <td>A1</td> <td>0.00</td> <td>0.07</td> <td>0.000</td> <td>0.003</td> </tr> <tr> <td>b</td> <td>0.25</td> <td>0.35</td> <td>0.010</td> <td>0.014</td> </tr> <tr> <td>C</td> <td>0.07</td> <td>0.20</td> <td>0.003</td> <td>0.008</td> </tr> <tr> <td>D</td> <td>1.10</td> <td>1.30</td> <td>0.043</td> <td>0.051</td> </tr> <tr> <td>E</td> <td>0.70</td> <td>0.90</td> <td>0.028</td> <td>0.035</td> </tr> <tr> <td>HE</td> <td>1.50</td> <td>1.70</td> <td>0.059</td> <td>0.067</td> </tr> <tr> <td>L</td> <td>0.15</td> <td>0.25</td> <td>0.006</td> <td>0.010</td> </tr> </tbody> </table>				SYMBOL	MILLIMETERS		INCHES		MIN	MAX	MIN	MAX	A	0.50	0.70	0.020	0.028	A1	0.00	0.07	0.000	0.003	b	0.25	0.35	0.010	0.014	C	0.07	0.20	0.003	0.008	D	1.10	1.30	0.043	0.051	E	0.70	0.90	0.028	0.035	HE	1.50	1.70	0.059
SYMBOL	MILLIMETERS		INCHES																																																	
	MIN	MAX	MIN	MAX																																																
A	0.50	0.70	0.020	0.028																																																
A1	0.00	0.07	0.000	0.003																																																
b	0.25	0.35	0.010	0.014																																																
C	0.07	0.20	0.003	0.008																																																
D	1.10	1.30	0.043	0.051																																																
E	0.70	0.90	0.028	0.035																																																
HE	1.50	1.70	0.059	0.067																																																
L	0.15	0.25	0.006	0.010																																																
<p>DIMENSIONS: MILLIMETERS</p>		<p><b>Notes:</b> Controlling Dimension: Millimeter.</p>																																																		

Marking Codes

Part Number	PESD5V0U1UB
Marking Code	

Package Information

Qty: 5k/Reel