

# LP3984 Micropower 150 mA Ultra Low-Dropout CMOS Voltage Regulator in Subminiature 4-I/O DSBGA Package

Check for Samples: [LP3984](#)

## FEATURES

- Miniature 4-I/O DSBGA or SOT-23-5 Package
- Logic controlled enable
- Stable with Tantalum Capacitors
- 1  $\mu\text{F}$  Tantalum Output Capacitor
- Fast Turn-On
- Thermal Shutdown and Short-Circuit Current Limit

## KEY SPECIFICATIONS

- 2.5 to 6.0V Input Range
- 150 mA Output
- 60 dB PSRR at 1 kHz, 40 dB at 10 kHz @ 3.1V<sub>IN</sub>
- $\leq 1.2 \mu\text{A}$  Quiescent Current when Shut Down
- Fast Turn-On Time: 20  $\mu\text{s}$  (typ.)
- 75 mV typ Dropout with 150 mA Load
- $-40$  to  $+125^\circ\text{C}$  Junction Temperature Range for Operation
- 1.5V, 1.8V, 2.9V and 3.1V

## APPLICATIONS

- CDMA Cellular Handsets
- Wideband CDMA Cellular Handsets
- GSM Cellular Handsets
- Portable Information Appliances

## Typical Application Circuit

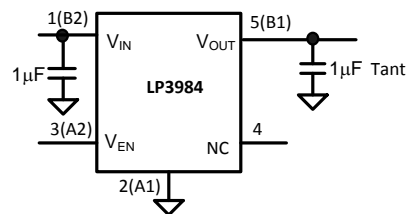

Note: Pin Numbers in parenthesis indicate DSBGA package.

## DESCRIPTION

The LP3984 is designed for portable and wireless applications with demanding performance and space requirements.

The LP3984's performance is optimized for battery powered systems to deliver extremely low dropout voltage and low quiescent current. Regulator ground current increases only slightly in dropout, further prolonging the battery life.

Power supply rejection is better than 60 dB at low frequencies and starts to roll off at 10 kHz. High power supply rejection is maintained down to low input voltage levels common to battery operated circuits.

The device is ideal for mobile phone and similar battery powered wireless applications. It provides up to 150 mA from a 2.5V to 6V input. The LP3984 consumes less than 1.2  $\mu\text{A}$  in disable mode and has fast turn-on time less than 20  $\mu\text{s}$ .

The LP3984 is available in a 4-bump DSBGA and 5-pin SOT-23 packages. Performance is specified for  $-40^\circ\text{C}$  to  $+125^\circ\text{C}$  temperature range and is available in 1.5V, 1.8V, 2.9V and 3.1V output voltages. For other output voltage options from 1.5V to 3.5V, please contact TI sales office.



Please be aware that an important notice concerning availability, standard warranty, and use in critical applications of Texas Instruments semiconductor products and disclaimers thereto appears at the end of this data sheet.

All trademarks are the property of their respective owners.

**Block Diagram**

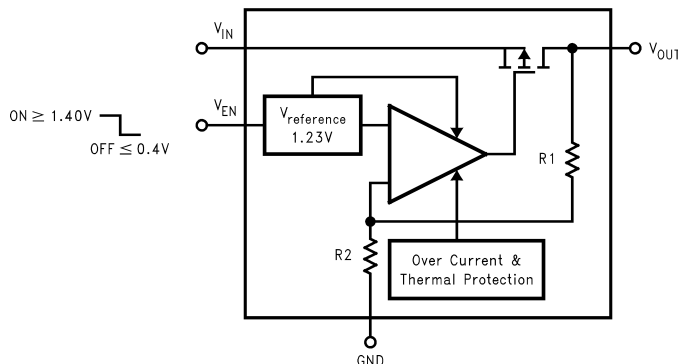

**Pin Descriptions**

| Name             | DSBGA (1) | SOT | Function                        |
|------------------|-----------|-----|---------------------------------|
| V <sub>EN</sub>  | A2        | 3   | Enable Input Logic, Enable High |
| GND              | A1        | 2   | Common Ground                   |
| V <sub>OUT</sub> | B1        | 5   | Output Voltage of the LDO       |
| V <sub>IN</sub>  | B2        | 1   | Input Voltage of the LDO        |
| N.C.             |           | 4   | No Connection                   |

(1) The pin numbering scheme for the DSBGA package was revised in April 2002 to conform to JEDEC standards. Only the pin numbers were revised. No changes to the physical locations of the inputs/outputs were made. For reference purposes, the obsolete numbering scheme had GND as pin 1, V<sub>OUT</sub> as pin 2, V<sub>IN</sub> as pin 3 and V<sub>EN</sub> as pin 4.

**Connection Diagram**

**SOT-23-5 Package**

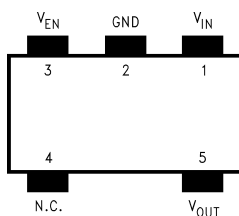

**Figure 1. Top View**  
See Package Number DBV

**DSBGA, 4-Bump Package**

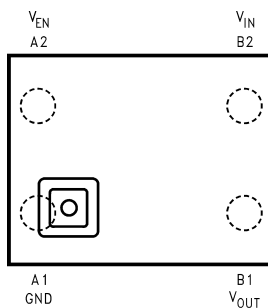

**Figure 2. Top View**  
See Package Number YPB0004



These devices have limited built-in ESD protection. The leads should be shorted together or the device placed in conductive foam during storage or handling to prevent electrostatic damage to the MOS gates.

### ABSOLUTE MAXIMUM RATINGS<sup>(1)(2)(3)</sup>

|  |                  |                                  |
|--|------------------|----------------------------------|
| $V_{IN}, V_{EN}$                         |                  | -0.3 to 6.5V                     |
| $V_{OUT}$                                |                  | -0.3 to $(V_{IN}+0.3) \leq 6.5V$ |
| Junction Temperature                     |                  | 150°C                            |
| Storage Temperature                      |                  | -65°C to +150°C                  |
| Lead Temp.                               |                  | 235°C                            |
| Pad Temp. <sup>(4)</sup>                 |                  | 235°C                            |
| Maximum Power Dissipation <sup>(5)</sup> | SOT-23-5         | 364 mW                           |
|  | DSBGA            | 235 mW                           |
| ESD Rating <sup>(6)</sup>                | Human Body Model | 2kV                              |
|  | Machine Model    | 200V                             |

- (1) Stresses beyond those listed under absolute maximum ratings may cause permanent damage to the device. These are stress ratings only, and functional operation of the device at these or any other conditions beyond those indicated under recommended operating conditions is not implied. Exposure to absolute-maximum-rated conditions for extended periods may affect device reliability.
- (2) All voltages are with respect to the potential at the GND pin.
- (3) If Military/Aerospace specified devices are required, please contact the Texas Instruments Sales Office/ Distributors for availability and specifications.
- (4) Additional information on pad temperature can be found in the TI AN-1112 Application Report ( ).
- (5) The Absolute Maximum power dissipation depends on the ambient temperature and can be calculated using the formula:  $P_D = (T_J - T_A)/\theta_{JA}$ , where  $T_J$  is the junction temperature,  $T_A$  is the ambient temperature, and  $\theta_{JA}$  is the junction-to-ambient thermal resistance. The 364 mW rating for SOT23-5 appearing under Absolute Maximum Ratings results from substituting the Absolute Maximum junction temperature, 150°C, for  $T_J$ , 70°C for  $T_A$ , and 220°C/W for  $\theta_{JA}$ . More power can be dissipated safely at ambient temperatures below 70°C. Less power can be dissipated safely at ambient temperatures above 70°C. The Absolute Maximum power dissipation for SOT23-5 can be increased by 4.5 mW for each degree below 70°C, and it must be derated by 4.5mW for each degree above 70°C.
- (6) The human body model is 100pF discharged through 1.5kΩ resistor into each pin. The machine model is a 200 pF capacitor discharged directly into each pin.

### OPERATING RATINGS<sup>(1)(2)</sup>

|  |                         |                              |
|--|-------------------------|------------------------------|
| $V_{IN}$                                 |                         | 2.5 to 6V                    |
| $V_{EN}$                                 |                         | 0 to $(V_{IN}+0.3V) \leq 6V$ |
| Junction Temperature                     |                         | -40°C to +125°C              |
| Thermal Resistance                       | $\theta_{JA}$ (SOT23-5) | 220°C/W                      |
|  | $\theta_{JA}$ (DSBGA)   | 340°C/W                      |
| Maximum Power Dissipation <sup>(3)</sup> | SOT-23-5                | 250mW                        |
|  | DSBGA                   | 160mW                        |

- (1) Stresses beyond those listed under absolute maximum ratings may cause permanent damage to the device. These are stress ratings only, and functional operation of the device at these or any other conditions beyond those indicated under recommended operating conditions is not implied. Exposure to absolute-maximum-rated conditions for extended periods may affect device reliability.
- (2) All voltages are with respect to the potential at the GND pin.
- (3) Like the Absolute Maximum power dissipation, the maximum power dissipation for operation depends on the ambient temperature. The 250mW rating for SOT23-5 appearing under Operating Ratings results from substituting the maximum junction temperature for operation, 125°C, for  $T_J$ , 70°C for  $T_A$ , and 220°C/W for  $\theta_{JA}$  using the formula:  $P_D = (T_J - T_A)/\theta_{JA}$ . More power can be dissipated at ambient temperatures below 70°C. Less power can be dissipated at ambient temperatures above 70°C. The maximum power dissipation for operation can be increased by 4.5 mW for each degree below 70°C, and it must be derated by 4.5mW for each degree above 70°C.

## ELECTRICAL CHARACTERISTICS

Unless otherwise specified:  $V_{IN} = 2.5V$  for 1.5V and 1.8V options,  $V_{IN} = V_{OUT} + 0.5$  for output options higher than 2.5V,  $C_{IN} = 1 \mu F$ ,  $I_{OUT} = 1mA$ ,  $C_{OUT} = 1 \mu F$ , tantalum. Typical values and limits appearing in standard typeface are for  $T_J = 25^\circ C$ . Limits appearing in **boldface type** apply over the entire junction temperature range for operation,  $-40^\circ C$  to  $+125^\circ C$ . <sup>(1)</sup> <sup>(2)</sup>

| Symbol           | Parameter                              | Conditions  | Typ             | Limit               |                              | Units               |
|------------------|--|---|-----------------|---------------------|------------------------------|---------------------|
|                  |  |   |                 | Min                 | Max                          |                     |
| $\Delta V_{OUT}$ | Output Voltage Tolerance               |   |                 | -1.2<br><b>-2.0</b> | 1.2<br><b>2.0</b>            | % of $V_{OUT(nom)}$ |
|                  | Line Regulation Error                  | $V_{IN} = 2.5V$ to $4.5V$ for 1.5V and 1.8V options<br>$V_{IN} = (V_{OUT} + 0.5V)$ to $4.5V$ for Voltage options higher than 2.5V | 0.05            | <b>-0.15</b>        | <b>0.15</b>                  | %/V                 |
|                  | Load Regulation Error <sup>(3)</sup>   | $I_{OUT} = 1mA$ to $150mA$<br>LP3984IM5 (SOT-23-5)<br>LP3984IBP (DSBGA)   | 0.002<br>0.0009 |                     | <b>0.005</b><br><b>0.002</b> | %/mA                |
| PSRR             | Power Supply Rejection Ratio           | $V_{IN} = V_{OUT(nom)} + 0.2V$ ,<br>$f = 1kHz$ ,<br>$I_{OUT} = 50mA$ , <a href="#">Figure 4</a>                                   | 60              |                     |                              | dB                  |
|                  |  | $V_{IN} = V_{OUT(nom)} + 0.2V$ ,<br>$f = 10kHz$ ,<br>$I_{OUT} = 50mA$ , <a href="#">Figure 4</a>                                  | 40              |                     |                              |                     |
| $I_Q$            | Quiescent Current                      | $V_{EN} = 1.4V$ , $I_{OUT} = 0mA$   | 80              |                     | <b>125</b>                   | $\mu A$             |
|                  |  | $V_{EN} = 1.4V$ , $I_{OUT} = 0$ to $150mA$  | 110             |                     | <b>150</b>                   |                     |
|                  |  | $V_{EN} = 0.4V$   | 0.005           |                     | <b>1.2</b>                   |                     |
|                  | Dropout Voltage <sup>(4)</sup>         | $I_{OUT} = 1mA$   | 0.6             |                     | <b>2.5</b>                   | mV                  |
|                  |  | $I_{OUT} = 50mA$  | 25              |                     | <b>40</b>                    |                     |
|                  |  | $I_{OUT} = 100mA$   | 50              |                     | <b>80</b>                    |                     |
|                  |  | $I_{OUT} = 150mA$   | 75              |                     | <b>120</b>                   |                     |
| $I_{SC}$         | Short Circuit Current Limit            | Output Grounded (Steady State)  | 600             |                     |                              | mA                  |
| $I_{OUT(PK)}$    | Peak Output Current                    | $V_{OUT} \geq V_{OUT(nom)} - 5\%$   | 600             | <b>300</b>          |                              | mA                  |
| $T_{ON}$         | Turn-On Time <sup>(5)</sup>            |   | 20              |                     |                              | $\mu s$             |
| $e_n$            | Output Noise Voltage                   | BW = 10 Hz to 100 kHz,<br>$C_{OUT} = 1\mu F$ tant.  | 90              |                     |                              | $\mu V_{rms}$       |
| $I_{EN}$         | Maximum Input Current at EN            | $V_{EN} = 0.4$ and $V_{IN} = 6.0$   | $\pm 1$         |                     |                              | nA                  |
| $V_{IL}$         | Maximum Low Level Input Voltage at EN  | $V_{IN} = 2.5$ to $6.0V$  |                 |                     | <b>0.4</b>                   | V                   |
| $V_{IH}$         | Minimum High Level Input Voltage at EN | $V_{IN} = 2.5$ to $6.0V$  |                 | <b>1.4</b>          |                              | V                   |
| $C_{OUT}$        | Output Capacitor                       | Capacitance   |                 | <b>1</b>            | <b>22</b>                    | $\mu F$             |
|                  |  | ESR   |                 | <b>2</b>            | <b>10</b>                    | $\Omega$            |
| TSD              | Thermal Shutdown Temperature           |   | 160             |                     |                              | $^\circ C$          |
|                  | Thermal Shutdown Hysteresis            |   | 20              |                     |                              | $^\circ C$          |

- (1) Min and Max Limits are verified by design, test, or statistical analysis. Typical (Typ.) numbers are not verified, but do represent the most likely norm.
- (2) The target output voltage, which is labeled  $V_{OUT(nom)}$ , is the desired voltage option.
- (3) An increase in the load current results in a slight decrease in the output voltage and vice versa.
- (4) Dropout voltage is the input-to-output voltage difference at which the output voltage is 100 mV below its nominal value. This specification does not apply for input voltages below 2.5V.
- (5) Turn-on time is time measured between the enable input just exceeding  $V_{IH}$  and the output voltage just reaching 95% of its nominal value.

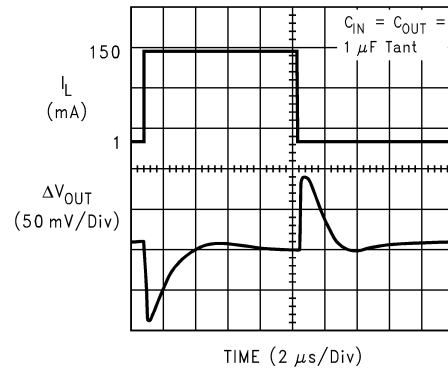

**Figure 3. Line Transient Input Test Signal**

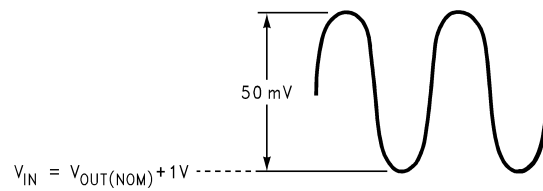

**Figure 4. PSRR Input Test Signal**

### TYPICAL PERFORMANCE CHARACTERISTICS

Unless otherwise specified,  $C_{IN} = C_{OUT} = 1 \mu\text{F}$  Tantalum,  $V_{IN} = 2.5$  for 1.5V and 1.8V options,  $V_{IN} = V_{OUT} + 0.2\text{V}$  for output options higher than 2.5V,  $T_A = 25^\circ\text{C}$ , Enable pin is tied to  $V_{IN}$ .

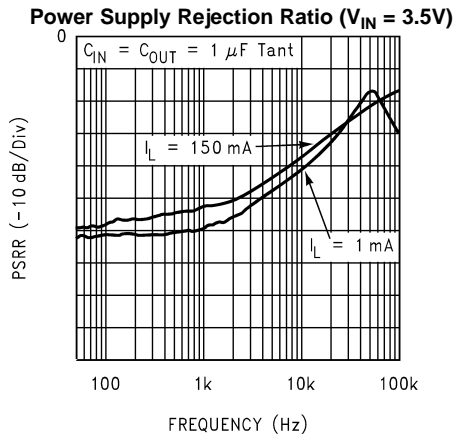

Figure 5.

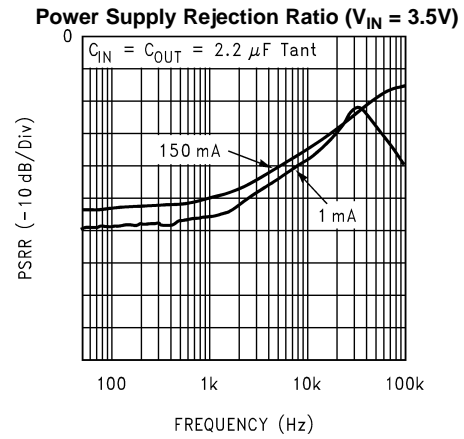

Figure 6.

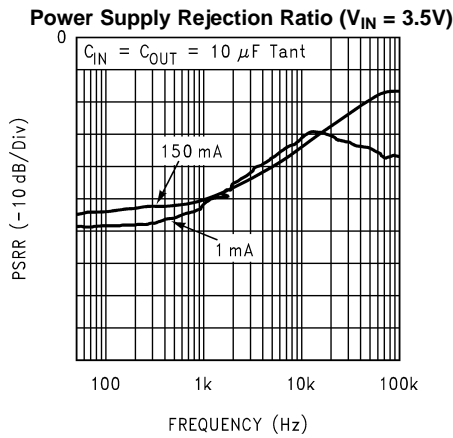

Figure 7.

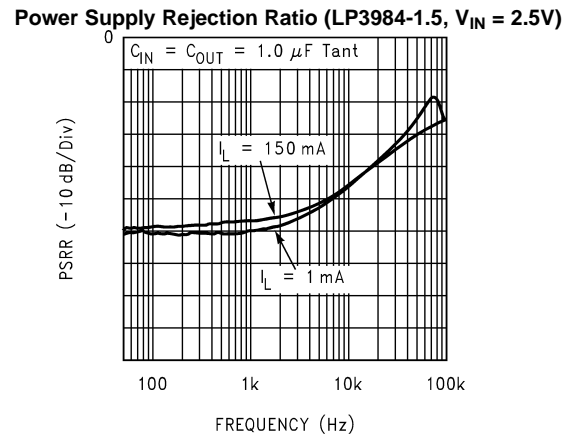

Figure 8.

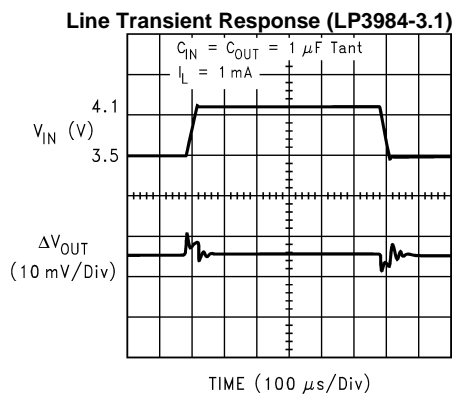

Figure 9.

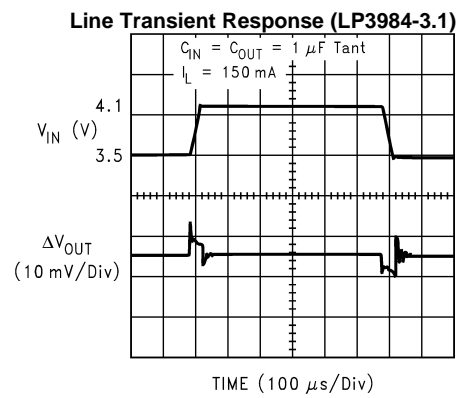
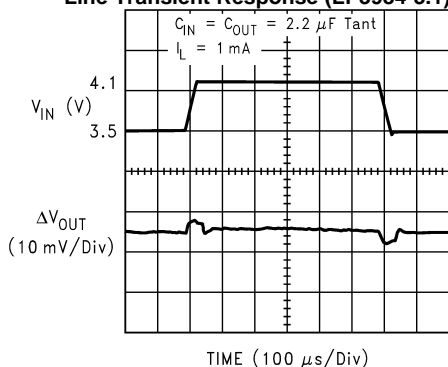

Figure 10.

**TYPICAL PERFORMANCE CHARACTERISTICS (continued)**

Unless otherwise specified,  $C_{IN} = C_{OUT} = 1 \mu\text{F}$  Tantalum,  $V_{IN} = 2.5$  for 1.5V and 1.8V options,  $V_{IN} = V_{OUT} + 0.2\text{V}$  for output options higher than 2.5V,  $T_A = 25^\circ\text{C}$ , Enable pin is tied to  $V_{IN}$ .

**Line Transient Response (LP3984-3.1)**



**Figure 11.**

**Line Transient Response (LP3984-3.1)**

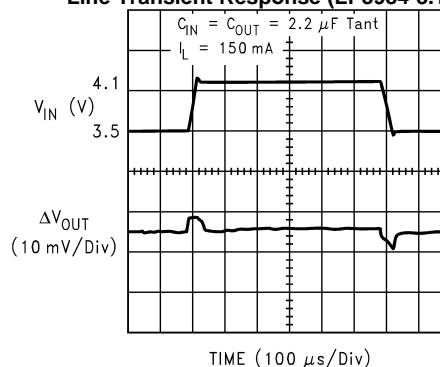

**Figure 12.**

**Line Transient Response (LP3984-3.1)**

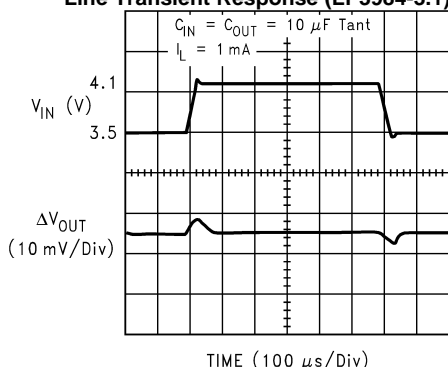

**Figure 13.**

**Line Transient Response (LP3984-3.1)**

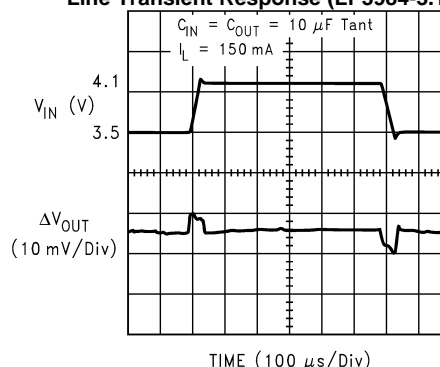

**Figure 14.**

**Start Up Response**

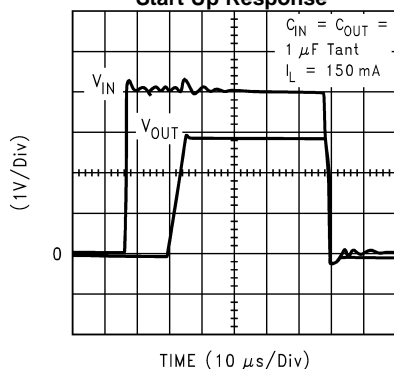

**Figure 15.**

**Start Up Response**

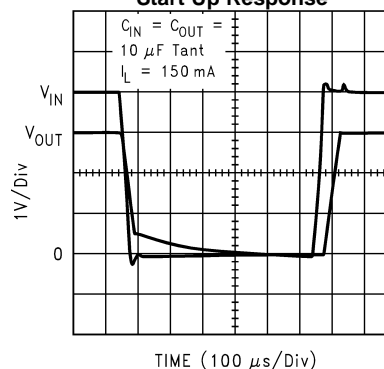

**Figure 16.**

**TYPICAL PERFORMANCE CHARACTERISTICS (continued)**

Unless otherwise specified,  $C_{IN} = C_{OUT} = 1 \mu\text{F}$  Tantalum,  $V_{IN} = 2.5$  for 1.5V and 1.8V options,  $V_{IN} = V_{OUT} + 0.2\text{V}$  for output options higher than 2.5V,  $T_A = 25^\circ\text{C}$ , Enable pin is tied to  $V_{IN}$ .

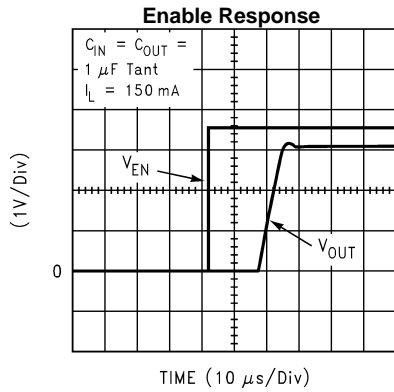

Figure 17.

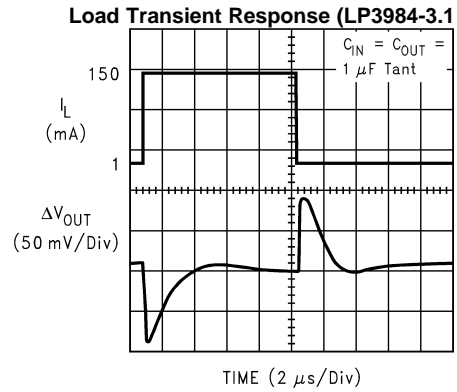

Figure 18.

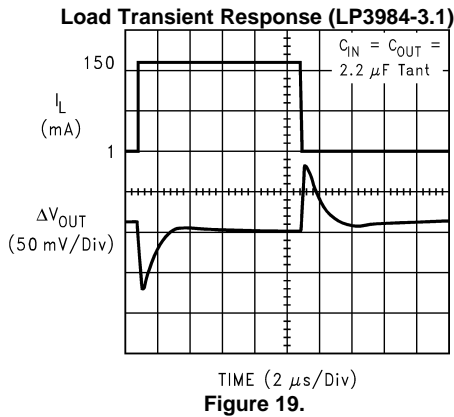

Figure 19.

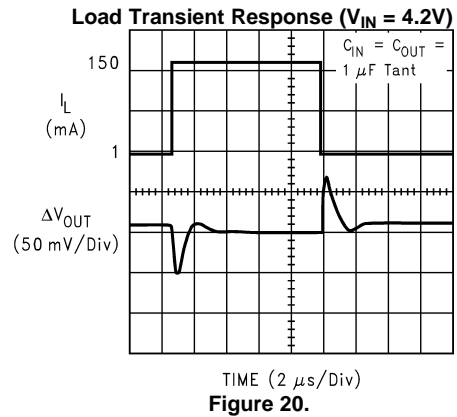

Figure 20.



## APPLICATION HINTS

### External Capacitors

Like any low-dropout regulator, the LP3984 requires external capacitors for regulator stability. The LP3984 is specifically designed for portable applications requiring minimum board space and smallest components. These capacitors must be correctly selected for good performance.

### Input Capacitors

An input capacitance of  $\approx 1 \mu\text{F}$  is required between the LP3984 input pin and ground (the amount of the capacitance may be increased without limit).

This capacitor must be located a distance of not more than 1 cm from the input pin and returned to a clean analog ground. Any good quality ceramic, tantalum, or film capacitor may be used at the input.

**Important:** Tantalum capacitors can suffer catastrophic failures due to surge current when connected to a low-impedance source of power (like a battery or a very large capacitor). If a tantalum capacitor is used at the input, it must be specified by the manufacturer to have a surge current rating sufficient for the application.

There are no requirements for the ESR on the input capacitor, but tolerance and temperature coefficient must be considered when selecting the capacitor to ensure the capacitance will be  $\approx 1 \mu\text{F}$  over the entire operating temperature range.

### Output Capacitor

The LP3984 is designed specifically to work with tantalum output capacitors. A tantalum capacitor in 1 to 22  $\mu\text{F}$  range with 2 $\Omega$  to 10 $\Omega$  ESR range is suitable in the LP3984 application circuit.

It may also be possible to use film capacitors at the output, but these are not as attractive for reasons of size and cost.

The output capacitor must meet the requirement for minimum amount of capacitance and also have an ESR (Equivalent Series Resistance) value which is within a stable range (2 $\Omega$  to 10 $\Omega$ ).

### No-Load Stability

The LP3984 will remain stable and in regulation with no external load. This is specially important in CMOS RAM keep-alive applications.

### On/Off Input Operation

The LP3984 is turned off by pulling the  $V_{\text{EN}}$  pin low, and turned on by pulling it high. If this feature is not used, the  $V_{\text{EN}}$  pin should be tied to  $V_{\text{IN}}$  to keep the regulator output on at all times. To assure proper operation, the signal source used to drive the  $V_{\text{EN}}$  input must be able to swing above and below the specified turn-on/off voltage thresholds listed in the Electrical Characteristics section under  $V_{\text{IL}}$  and  $V_{\text{IH}}$ .

### Fast On-Time

The LP3984 output is turned on after  $V_{\text{ref}}$  voltage reaches its final value (1.23V nominal). To speed up this process, the noise reduction capacitor at the bypass pin is charged with an internal 70  $\mu\text{A}$  current source. The current source is turned off when the bandgap voltage reaches approximately 95% of its final value. The turn-on time is determined by the time constant of the bypass capacitor. The smaller the capacitor value, the shorter the turn-on time, but less noise gets reduced. As a result, turn-on time and noise reduction need to be taken into design consideration when choosing the value of the bypass capacitor.

## DSBGA Mounting

The DSBGA package requires specific mounting techniques which are detailed in the AN-1112 Application Report ([SNVA009](#)). Referring to the section *PCB Layout*; note that the pad style which must be used with the 5-pin package is NSMD (non-solder mask defined) type.

For best results during assembly, alignment ordinals on the PC board may be used to facilitate placement of the DSBGA device.

## DSBGA Light Sensitivity

Exposing the DSBGA device to direct sunlight will cause mis-operation of the device. Light sources such as halogen lamps can affect electrical performance if brought near to the device.

The wavelengths which have most detrimental effect are reds and infra-reds, which means that the fluorescent lighting used inside most buildings has very little effect on performance. A DSBGA test board was brought to within 1 cm of a fluorescent desk lamp and the effect on the regulated output voltage was negligible, showing a deviation of less than 0.1% from nominal.

---

**REVISION HISTORY****Changes from Revision D (May 2013) to Revision E** **Page**

- 
- Changed layout of National Data Sheet to TI format; correct typos ..... 10
- 

**Changes from Revision E (May 2013) to Revision F** **Page**

- 
- Deleted 2.0V option which is obsoleted ..... 1
  - Deleted legacy ordering table ..... 3
-

**PACKAGING INFORMATION**

| Orderable Device    | Status<br>(1) | Package Type | Package Drawing | Pins | Package Qty | Eco Plan<br>(2)         | Lead/Ball Finish<br>(6) | MSL Peak Temp<br>(3) | Op Temp (°C) | Device Marking<br>(4/5) | Samples |
|---------------------|---------------|--------------|-----------------|------|-------------|-------------------------|-------------------------|----------------------|--------------|-------------------------|---------|
| LP3984IMF-1.5       | LIFEBUY       | SOT-23       | DBV             | 5    | 1000        | TBD                     | Call TI                 | Call TI              |              | LEAB                    |         |
| LP3984IMF-1.5/NOPB  | LIFEBUY       | SOT-23       | DBV             | 5    | 1000        | Green (RoHS & no Sb/Br) | CU SN                   | Level-1-260C-UNLIM   |              | LEAB                    |         |
| LP3984IMF-1.8       | LIFEBUY       | SOT-23       | DBV             | 5    | 1000        | TBD                     | Call TI                 | Call TI              |              | LEBB                    |         |
| LP3984IMF-1.8/NOPB  | LIFEBUY       | SOT-23       | DBV             | 5    | 1000        | Green (RoHS & no Sb/Br) | CU SN                   | Level-1-260C-UNLIM   |              | LEBB                    |         |
| LP3984IMF-3.1/NOPB  | LIFEBUY       | SOT-23       | DBV             | 5    | 1000        | Green (RoHS & no Sb/Br) | CU SN                   | Level-1-260C-UNLIM   | -40 to 125   | LEDB                    |         |
| LP3984IMFX-1.8      | NRND          | SOT-23       | DBV             | 5    |             | TBD                     | Call TI                 | Call TI              | -40 to 125   | LEBB                    |         |
| LP3984IMFX-1.8/NOPB | LIFEBUY       | SOT-23       | DBV             | 5    | 3000        | Green (RoHS & no Sb/Br) | CU SN                   | Level-1-260C-UNLIM   | -40 to 125   | LEBB                    |         |
| LP3984ITP-2.9/NOPB  | LIFEBUY       | DSBGA        | YPB             | 4    | 250         | Green (RoHS & no Sb/Br) | SNAGCU                  | Level-1-260C-UNLIM   | -40 to 125   |                         |         |
| LP3984ITPX-1.8/NOPB | LIFEBUY       | DSBGA        | YPB             | 4    | 3000        | Green (RoHS & no Sb/Br) | SNAGCU                  | Level-1-260C-UNLIM   | -40 to 125   |                         |         |

(1) The marketing status values are defined as follows:

**ACTIVE:** Product device recommended for new designs.

**LIFEBUY:** TI has announced that the device will be discontinued, and a lifetime-buy period is in effect.

**NRND:** Not recommended for new designs. Device is in production to support existing customers, but TI does not recommend using this part in a new design.

**PREVIEW:** Device has been announced but is not in production. Samples may or may not be available.

**OBSOLETE:** TI has discontinued the production of the device.

(2) Eco Plan - The planned eco-friendly classification: Pb-Free (RoHS), Pb-Free (RoHS Exempt), or Green (RoHS & no Sb/Br) - please check <http://www.ti.com/productcontent> for the latest availability information and additional product content details.

**TBD:** The Pb-Free/Green conversion plan has not been defined.

**Pb-Free (RoHS):** TI's terms "Lead-Free" or "Pb-Free" mean semiconductor products that are compatible with the current RoHS requirements for all 6 substances, including the requirement that lead not exceed 0.1% by weight in homogeneous materials. Where designed to be soldered at high temperatures, TI Pb-Free products are suitable for use in specified lead-free processes.

**Pb-Free (RoHS Exempt):** This component has a RoHS exemption for either 1) lead-based flip-chip solder bumps used between the die and package, or 2) lead-based die adhesive used between the die and leadframe. The component is otherwise considered Pb-Free (RoHS compatible) as defined above.

**Green (RoHS & no Sb/Br):** TI defines "Green" to mean Pb-Free (RoHS compatible), and free of Bromine (Br) and Antimony (Sb) based flame retardants (Br or Sb do not exceed 0.1% by weight in homogeneous material)

(3) MSL, Peak Temp. - The Moisture Sensitivity Level rating according to the JEDEC industry standard classifications, and peak solder temperature.

(4) There may be additional marking, which relates to the logo, the lot trace code information, or the environmental category on the device.

<sup>(5)</sup> Multiple Device Markings will be inside parentheses. Only one Device Marking contained in parentheses and separated by a "~" will appear on a device. If a line is indented then it is a continuation of the previous line and the two combined represent the entire Device Marking for that device.

<sup>(6)</sup> Lead/Ball Finish - Orderable Devices may have multiple material finish options. Finish options are separated by a vertical ruled line. Lead/Ball Finish values may wrap to two lines if the finish value exceeds the maximum column width.

**Important Information and Disclaimer:** The information provided on this page represents TI's knowledge and belief as of the date that it is provided. TI bases its knowledge and belief on information provided by third parties, and makes no representation or warranty as to the accuracy of such information. Efforts are underway to better integrate information from third parties. TI has taken and continues to take reasonable steps to provide representative and accurate information but may not have conducted destructive testing or chemical analysis on incoming materials and chemicals. TI and TI suppliers consider certain information to be proprietary, and thus CAS numbers and other limited information may not be available for release.

In no event shall TI's liability arising out of such information exceed the total purchase price of the TI part(s) at issue in this document sold by TI to Customer on an annual basis.

## TAPE AND REEL INFORMATION



### QUADRANT ASSIGNMENTS FOR PIN 1 ORIENTATION IN TAPE



\*All dimensions are nominal

| Device              | Package Type | Package Drawing | Pins | SPQ  | Reel Diameter (mm) | Reel Width W1 (mm) | A0 (mm) | B0 (mm) | K0 (mm) | P1 (mm) | W (mm) | Pin1 Quadrant |
|---------------------|--------------|-----------------|------|------|--------------------|--------------------|---------|---------|---------|---------|--------|---------------|
| LP3984IMF-1.5       | SOT-23       | DBV             | 5    | 1000 | 178.0              | 8.4                | 3.2     | 3.2     | 1.4     | 4.0     | 8.0    | Q3            |
| LP3984IMF-1.5/NOPB  | SOT-23       | DBV             | 5    | 1000 | 178.0              | 8.4                | 3.2     | 3.2     | 1.4     | 4.0     | 8.0    | Q3            |
| LP3984IMF-1.8       | SOT-23       | DBV             | 5    | 1000 | 178.0              | 8.4                | 3.2     | 3.2     | 1.4     | 4.0     | 8.0    | Q3            |
| LP3984IMF-1.8/NOPB  | SOT-23       | DBV             | 5    | 1000 | 178.0              | 8.4                | 3.2     | 3.2     | 1.4     | 4.0     | 8.0    | Q3            |
| LP3984IMF-3.1/NOPB  | SOT-23       | DBV             | 5    | 1000 | 178.0              | 8.4                | 3.2     | 3.2     | 1.4     | 4.0     | 8.0    | Q3            |
| LP3984IMFX-1.8/NOPB | SOT-23       | DBV             | 5    | 3000 | 178.0              | 8.4                | 3.2     | 3.2     | 1.4     | 4.0     | 8.0    | Q3            |
| LP3984ITP-2.9/NOPB  | DSBGA        | YPB             | 4    | 250  | 178.0              | 8.4                | 1.02    | 1.09    | 0.66    | 4.0     | 8.0    | Q1            |
| LP3984ITPX-1.8/NOPB | DSBGA        | YPB             | 4    | 3000 | 178.0              | 8.4                | 1.02    | 1.09    | 0.66    | 4.0     | 8.0    | Q1            |

**TAPE AND REEL BOX DIMENSIONS**

\*All dimensions are nominal

| Device              | Package Type | Package Drawing | Pins | SPQ  | Length (mm) | Width (mm) | Height (mm) |
|---------------------|--------------|-----------------|------|------|-------------|------------|-------------|
| LP3984IMF-1.5       | SOT-23       | DBV             | 5    | 1000 | 210.0       | 185.0      | 35.0        |
| LP3984IMF-1.5/NOPB  | SOT-23       | DBV             | 5    | 1000 | 210.0       | 185.0      | 35.0        |
| LP3984IMF-1.8       | SOT-23       | DBV             | 5    | 1000 | 210.0       | 185.0      | 35.0        |
| LP3984IMF-1.8/NOPB  | SOT-23       | DBV             | 5    | 1000 | 210.0       | 185.0      | 35.0        |
| LP3984IMF-3.1/NOPB  | SOT-23       | DBV             | 5    | 1000 | 210.0       | 185.0      | 35.0        |
| LP3984IMFX-1.8/NOPB | SOT-23       | DBV             | 5    | 3000 | 210.0       | 185.0      | 35.0        |
| LP3984ITP-2.9/NOPB  | DSBGA        | YPB             | 4    | 250  | 210.0       | 185.0      | 35.0        |
| LP3984ITPX-1.8/NOPB | DSBGA        | YPB             | 4    | 3000 | 210.0       | 185.0      | 35.0        |

DBV (R-PDSO-G5)

PLASTIC SMALL-OUTLINE PACKAGE



- NOTES:
- A. All linear dimensions are in millimeters.
  - B. This drawing is subject to change without notice.
  - C. Body dimensions do not include mold flash or protrusion. Mold flash and protrusion shall not exceed 0.15 per side.
  - D. Falls within JEDEC MO-178 Variation AA.



DBV (R-PDSO-G5)

PLASTIC SMALL OUTLINE



- NOTES:
- A. All linear dimensions are in millimeters.
  - B. This drawing is subject to change without notice.
  - C. Customers should place a note on the circuit board fabrication drawing not to alter the center solder mask defined pad.
  - D. Publication IPC-7351 is recommended for alternate designs.
  - E. Laser cutting apertures with trapezoidal walls and also rounding corners will offer better paste release. Customers should contact their board assembly site for stencil design recommendations. Example stencil design based on a 50% volumetric metal load solder paste. Refer to IPC-7525 for other stencil recommendations.



# PACKAGE OUTLINE

## YPB0004

### DSBGA - 0.575 mm max height

DIE SIZE BALL GRID ARRAY

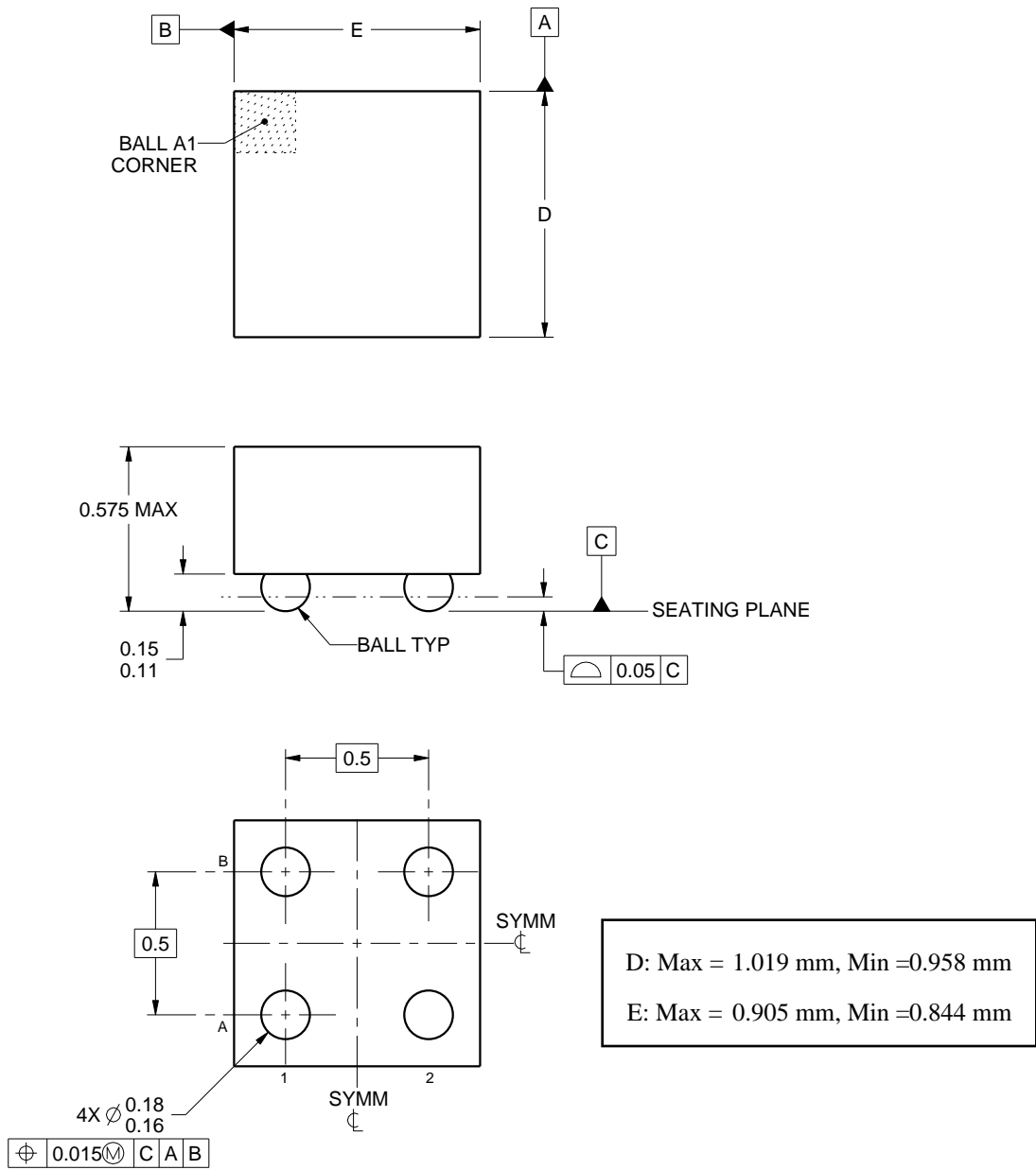

4215097/B 07/2016

#### NOTES:

1. All linear dimensions are in millimeters. Any dimensions in parenthesis are for reference only. Dimensioning and tolerancing per ASME Y14.5M.
2. This drawing is subject to change without notice.

# EXAMPLE BOARD LAYOUT

YPB0004

DSBGA - 0.575 mm max height

DIE SIZE BALL GRID ARRAY

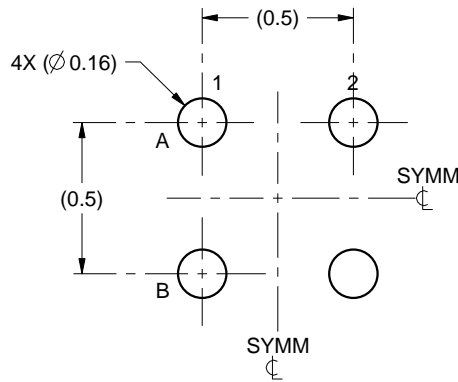

LAND PATTERN EXAMPLE  
SCALE:40X

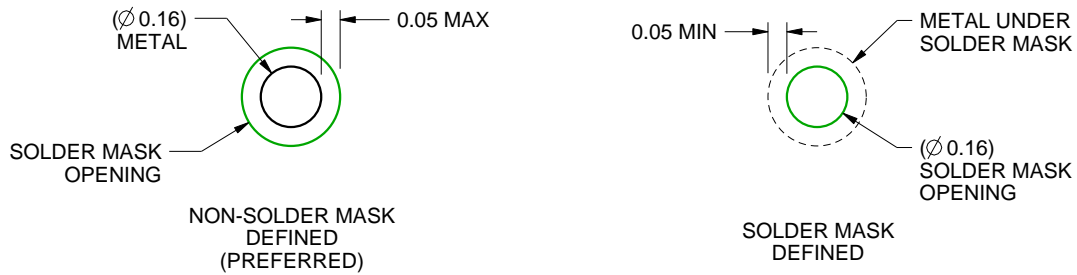

SOLDER MASK DETAILS  
NOT TO SCALE

4215097/B 07/2016

NOTES: (continued)

- Final dimensions may vary due to manufacturing tolerance considerations and also routing constraints. See Texas Instruments Literature No. SNVA009 ([www.ti.com/lit/snva009](http://www.ti.com/lit/snva009)).

# EXAMPLE STENCIL DESIGN

YPB0004

DSBGA - 0.575 mm max height

DIE SIZE BALL GRID ARRAY

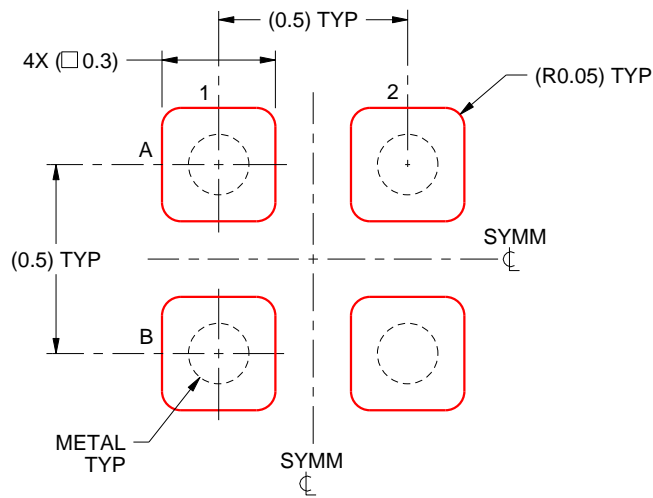

SOLDER PASTE EXAMPLE  
BASED ON 0.125mm THICK STENCIL  
SCALE:50X

4215097/B 07/2016

NOTES: (continued)

4. Laser cutting apertures with trapezoidal walls and rounded corners may offer better paste release.

## IMPORTANT NOTICE FOR TI DESIGN INFORMATION AND RESOURCES

Texas Instruments Incorporated ("TI") technical, application or other design advice, services or information, including, but not limited to, reference designs and materials relating to evaluation modules, (collectively, "TI Resources") are intended to assist designers who are developing applications that incorporate TI products; by downloading, accessing or using any particular TI Resource in any way, you (individually or, if you are acting on behalf of a company, your company) agree to use it solely for this purpose and subject to the terms of this Notice.

TI's provision of TI Resources does not expand or otherwise alter TI's applicable published warranties or warranty disclaimers for TI products, and no additional obligations or liabilities arise from TI providing such TI Resources. TI reserves the right to make corrections, enhancements, improvements and other changes to its TI Resources.

You understand and agree that you remain responsible for using your independent analysis, evaluation and judgment in designing your applications and that you have full and exclusive responsibility to assure the safety of your applications and compliance of your applications (and of all TI products used in or for your applications) with all applicable regulations, laws and other applicable requirements. You represent that, with respect to your applications, you have all the necessary expertise to create and implement safeguards that (1) anticipate dangerous consequences of failures, (2) monitor failures and their consequences, and (3) lessen the likelihood of failures that might cause harm and take appropriate actions. You agree that prior to using or distributing any applications that include TI products, you will thoroughly test such applications and the functionality of such TI products as used in such applications. TI has not conducted any testing other than that specifically described in the published documentation for a particular TI Resource.

You are authorized to use, copy and modify any individual TI Resource only in connection with the development of applications that include the TI product(s) identified in such TI Resource. NO OTHER LICENSE, EXPRESS OR IMPLIED, BY ESTOPPEL OR OTHERWISE TO ANY OTHER TI INTELLECTUAL PROPERTY RIGHT, AND NO LICENSE TO ANY TECHNOLOGY OR INTELLECTUAL PROPERTY RIGHT OF TI OR ANY THIRD PARTY IS GRANTED HEREIN, including but not limited to any patent right, copyright, mask work right, or other intellectual property right relating to any combination, machine, or process in which TI products or services are used. Information regarding or referencing third-party products or services does not constitute a license to use such products or services, or a warranty or endorsement thereof. Use of TI Resources may require a license from a third party under the patents or other intellectual property of the third party, or a license from TI under the patents or other intellectual property of TI.

TI RESOURCES ARE PROVIDED "AS IS" AND WITH ALL FAULTS. TI DISCLAIMS ALL OTHER WARRANTIES OR REPRESENTATIONS, EXPRESS OR IMPLIED, REGARDING TI RESOURCES OR USE THEREOF, INCLUDING BUT NOT LIMITED TO ACCURACY OR COMPLETENESS, TITLE, ANY EPIDEMIC FAILURE WARRANTY AND ANY IMPLIED WARRANTIES OF MERCHANTABILITY, FITNESS FOR A PARTICULAR PURPOSE, AND NON-INFRINGEMENT OF ANY THIRD PARTY INTELLECTUAL PROPERTY RIGHTS.

TI SHALL NOT BE LIABLE FOR AND SHALL NOT DEFEND OR INDEMNIFY YOU AGAINST ANY CLAIM, INCLUDING BUT NOT LIMITED TO ANY INFRINGEMENT CLAIM THAT RELATES TO OR IS BASED ON ANY COMBINATION OF PRODUCTS EVEN IF DESCRIBED IN TI RESOURCES OR OTHERWISE. IN NO EVENT SHALL TI BE LIABLE FOR ANY ACTUAL, DIRECT, SPECIAL, COLLATERAL, INDIRECT, PUNITIVE, INCIDENTAL, CONSEQUENTIAL OR EXEMPLARY DAMAGES IN CONNECTION WITH OR ARISING OUT OF TI RESOURCES OR USE THEREOF, AND REGARDLESS OF WHETHER TI HAS BEEN ADVISED OF THE POSSIBILITY OF SUCH DAMAGES.

You agree to fully indemnify TI and its representatives against any damages, costs, losses, and/or liabilities arising out of your non-compliance with the terms and provisions of this Notice.

This Notice applies to TI Resources. Additional terms apply to the use and purchase of certain types of materials, TI products and services. These include; without limitation, TI's standard terms for semiconductor products (<http://www.ti.com/sc/docs/stdterms.htm>), [evaluation modules](#), and [samples](http://www.ti.com/sc/docs/sampterm.htm) (<http://www.ti.com/sc/docs/sampterm.htm>).

Mailing Address: Texas Instruments, Post Office Box 655303, Dallas, Texas 75265  
Copyright © 2017, Texas Instruments Incorporated