

**OP-27A, OP-27C, OP-27E, OP-27G
OP-37A, OP-37C, OP-37E, OP-37G**
LOW-NOISE, HIGH-SPEED, PRECISION OPERATIONAL AMPLIFIERS

D3176, FEBRUARY 1989

- Direct Replacements for PMI and LTC OP-27 and OP-37 Series

Features of OP-27A, OP-27C, OP-37A, and OP-37C:

- Maximum Equivalent Input Noise Voltage:
3.8 nV/√Hz at 1 kHz
5.5 nV/√Hz at 10 Hz
- Very Low Peak-to-Peak Noise Voltage at 0.1 Hz to 10 Hz . . . 80 nV Typ
- Low Input Offset Voltage . . . 25 μV Max
- High Voltage Amplification . . . 1 V/μV Min

Feature of OP-37 Series:

- Minimum Slew Rate . . . 11 V/μs

description

The OP-27 and OP-37 operational amplifiers combine outstanding noise performance with excellent precision and high-speed specifications. The wideband noise is only 3 nV/√Hz, and with the 1/f noise corner at 2.7 Hz, low noise is maintained for all low-frequency applications.

The outstanding characteristics of the OP-27 and OP-37 make these devices excellent choices for low-noise amplifier applications requiring precision performance and reliability. Additionally, the OP-37 is free of latch-up in high-gain, large-capacitive-feedback configurations.

The OP-27 series is compensated for unity gain. The OP-37 series is decompensated for increased bandwidth and slew rate and is stable down to a gain of 5.

The OP-27A, OP-27C, OP-37A, and OP-37C are characterized for operation over the full military temperature range of -55°C to 125°C. The OP-27E, OP-27G, OP-37E, and OP-37G are characterized for operation from -25°C to 85°C.

JG OR P PACKAGE
(TOP VIEW)

T-79-06-10

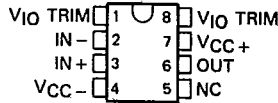

L PACKAGE
(TOP VIEW)

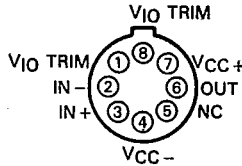

NC—No internal connection

symbol

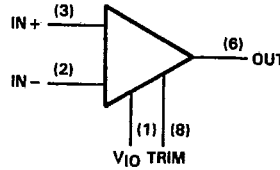

NOTICE

SEE ORDER OF DATA FOR ERRATA INFORMATION

2
Operational Amplifiers

AVAILABLE OPTIONS

TA	VIO MAX AT 25°C	STABLE GAIN	PACKAGE		
			CERAMIC DIP (JG)	METAL CAN (L)	PLASTIC DIP (P)
-25°C to 85°C	25 μV	1	OP27EJG	OP27EL	OP27EP
		5	OP37EJG	OP37EL	OP37EP
	100 μV	1	OP27GJG	OP27GL	OP27GP
		5	OP37GJG	OP37GL	OP37GP
-55°C to 125°C	25 μV	1	OP27AJG	OP27AL	OP27AP
		5	OP37AJG	OP37AL	OP37AP
	100 μV	1	OP27CJG	OP27CL	OP27CP
		5	OP37CJG	OP37CL	OP37CP

PRODUCTION DATA documents contain information current as of publication date. Products conform to specifications per the terms of Texas Instruments standard warranty. Production processing does not necessarily include testing of all parameters.



POST OFFICE BOX 655012 • DALLAS, TEXAS 75265

Copyright © 1989, Texas Instruments Incorporated

**OP-27A, OP-27C, OP-27E, OP-27G
OP-37A, OP-37C, OP-37E, OP-37G
LOW-NOISE, HIGH-SPEED, PRECISION OPERATIONAL AMPLIFIERS**

T-79-06-10

schematic

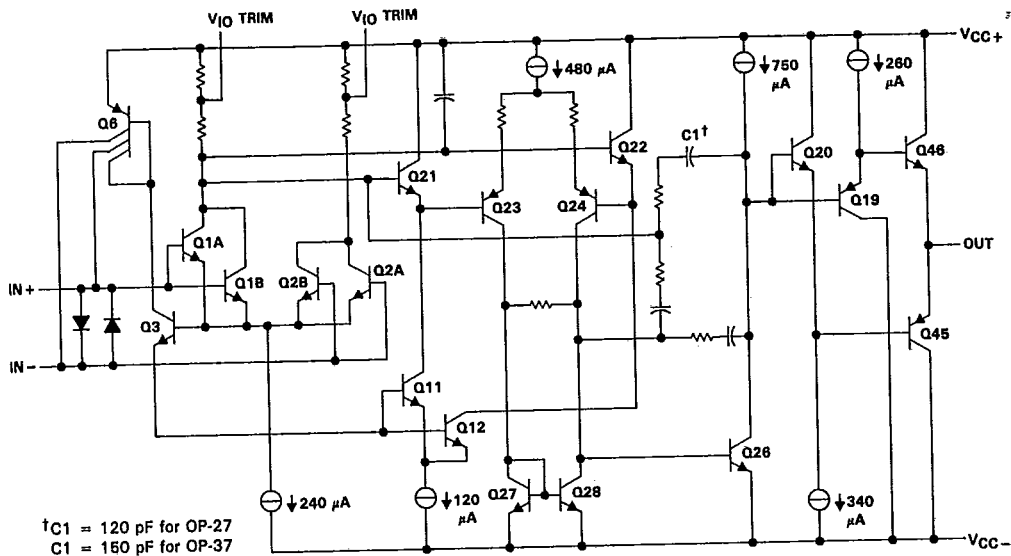

†C1 = 120 pF for OP-27
C1 = 150 pF for OP-37

2 Operational Amplifiers

absolute maximum ratings over operating free-air temperature range (unless otherwise noted)

Supply voltage, VCC+ (see Note 1)	22 V
Supply voltage, VCC- (see Note 1)	-22 V
Input voltage	VCC±
Duration of output short circuit	unlimited
Differential input current (see Note 2)	±25 mA
Continuous power dissipation	see Dissipation Rating Table
Operating free-air temperature range: OP-27A, OP-27C, OP-37A, OP-37C	-55°C to 125°C
OP-27E, OP-27G, OP-37E, OP-37G	-25°C to 85°C
Storage temperature range	-65°C to 150°C
Lead temperature 1,6 mm (1/16 inch) from case for 60 seconds: JG or L package	300°C
Lead temperature 1,6 mm (1/16 inch) from case for 10 seconds: P package	260°C

NOTES: 1. All voltage values are with respect to the midpoint between VCC+ and VCC- unless otherwise noted.
2. The inputs are protected by back-to-back diodes. Current-limiting resistors are not used in order to achieve low noise. Excessive input current will flow if a differential input voltage in excess of approximately ±0.7 V is applied between the inputs unless some limiting resistance is used.

DISSIPATION RATING TABLE

PACKAGE	TA ≤ 25°C POWER RATING	DERATING FACTOR ABOVE TA = 25°C	TA = 85°C POWER RATING	TA = 125°C POWER RATING
JG (OP-27A, OP-27C, OP-37A, OP-37C)	1050 mW	8.4 mW/°C	546 mW	210 mW
JG (OP-27E, OP-27G, OP-37E, OP-37G)	825 mW	6.6 mW/°C	429 mW	N/A
L (OP-27A, OP-27C, OP-37A, OP-37C)	825 mW	6.6 mW/°C	429 mW	165 mW
L (OP-27E, OP-27G, OP-37E, OP-37G)	650 mW	5.2 mW/°C	338 mW	N/A
P	1000 mW	8.0 mW/°C	520 mW	N/A

OP-27A, OP-27C, OP-37A, OP-37C
 LOW-NOISE, HIGH-SPEED, PRECISION OPERATIONAL AMPLIFIERS

T-79-06-10

recommended operating conditions

	OP-27A, OP-37A			OP-27C, OP-37C			UNIT
	MIN	NOM	MAX	MIN	NOM	MAX	
Supply voltage, V_{CC+}	4	15	22	4	15	22	V
Supply voltage, V_{CC-}	-4	-15	-22	-4	-15	-22	V
Common-mode input voltage, V_{ICR}	$V_{CC\pm} = \pm 15$ V, $T_A = 25^\circ\text{C}$			± 11			± 11
	$V_{CC\pm} = \pm 15$ V, $T_A = -55^\circ\text{C}$ to 125°C			± 10.3			± 10.2
Operating free-air temperature, T_A	-55	125		-55	125		$^\circ\text{C}$

electrical characteristics, $V_{CC\pm} = \pm 15$ V (unless otherwise noted)

PARAMETER	TEST CONDITIONS	T_A	OP-27A, OP-37A			OP-27C, OP-37C			UNIT
			MIN	TYP	MAX	MIN	TYP	MAX	
V_{IO} Input offset voltage	$V_O = 0, V_{IC} = 0$ $R_S = 50 \Omega$, See Note 3	25 $^\circ\text{C}$	10			30			μV
		-55 $^\circ\text{C}$ to 125 $^\circ\text{C}$	60			300			
$\propto V_{IO}$ Average temperature coefficient of input offset voltage		-55 $^\circ\text{C}$ to 125 $^\circ\text{C}$	0.2	0.6		0.4	1.8	$\mu\text{V}/^\circ\text{C}$	
Long-term drift of input offset voltage	See Note 4		0.2	1		0.4	2	$\mu\text{V}/\text{mo}$	
I_{IO} Input offset current	$V_O = 0, V_{IC} = 0$	25 $^\circ\text{C}$	7	35		12	75	nA	
		-55 $^\circ\text{C}$ to 125 $^\circ\text{C}$			50		135		
I_{IB} Input bias current	$V_O = 0, V_{IC} = 0$	25 $^\circ\text{C}$	± 10	± 40		± 15	± 80	nA	
		-55 $^\circ\text{C}$ to 125 $^\circ\text{C}$		± 60		± 150			
V_{ICR} Common-mode input voltage range		25 $^\circ\text{C}$	± 11			± 11			V
		-55 $^\circ\text{C}$ to 125 $^\circ\text{C}$	± 10.3			± 10.2			
V_{OM} Peak output voltage swing	$R_L \geq 2 \text{ k}\Omega$	25 $^\circ\text{C}$	$\pm 12 \pm 13.8$			$\pm 11.5 \pm 13.5$			V
			$\pm 10 \pm 11.5$			$\pm 10 \pm 11.5$			
		-55 $^\circ\text{C}$ to 125 $^\circ\text{C}$	± 11.5			± 10.5			
A_{VD} Large-signal differential voltage amplification	$R_L \geq 2 \text{ k}\Omega, V_O = \pm 10$ V $R_L \geq 1 \text{ k}\Omega, V_O = \pm 10$ V $R_L \geq 0.6 \text{ k}\Omega, V_O = \pm 1$ V $V_{CC} = \pm 4$ V	25 $^\circ\text{C}$	1000 1800		700 1500		V/mV		
			800 1500		1500				
			250 700		200 500				
		-55 $^\circ\text{C}$ to 125 $^\circ\text{C}$	600		300				
$r_{i(CM)}$ Common-mode input resistance			3			2			$\text{G}\Omega$
r_o Output resistance	$V_O = 0, I_O = 0$	25 $^\circ\text{C}$	70			70			Ω
CMRR Common-mode rejection ratio	$V_{IC} = \pm 11$ V $V_{IC} = \pm 10$ V	25 $^\circ\text{C}$	114	126		100	120	dB	
		-55 $^\circ\text{C}$ to 125 $^\circ\text{C}$	108			94			
kSVR Supply voltage rejection ratio	$V_{CC\pm} = \pm 4$ V to ± 18 V $V_{CC\pm} = \pm 4.5$ V to ± 18 V	25 $^\circ\text{C}$	100	120		94	118	dB	
		-55 $^\circ\text{C}$ to 125 $^\circ\text{C}$	96			86			

2 Operational Amplifiers

- NOTES: 3. Input offset voltage measurements are performed by automatic test equipment approximately 0.5 seconds after applying power.
 4. Long-term drift of input offset voltage refers to the average trend line of offset voltage versus time over extended periods after the first 30 days of operation. Excluding the initial hour of operation, changes in V_{IO} during the first 30 days are typically 2.5 μV . See Figure 3.

OP-27E, OP-37E, OP-27G, OP-37G
LOW-NOISE, HIGH-SPEED, PRECISION OPERATIONAL AMPLIFIERS

T-79-06-10

recommended operating conditions

	MIN	NOM	MAX	UNIT
Supply voltage, V_{CC+}	4	15	22	V
Supply voltage, V_{CC-}	-4	-15	-22	V
Common-mode input voltage, range	$V_{CC\pm} = \pm 15$ V, $T_A = 25^\circ\text{C}$			± 11 V
	$V_{CC\pm} = \pm 15$ V, $T_A = -55^\circ\text{C}$ to 125°C			± 10.5 V
Operating free-air temperature, T_A	-25		85	$^\circ\text{C}$

electrical characteristics, $V_{CC\pm} = \pm 15$ V (unless otherwise noted)

PARAMETER	TEST CONDITIONS	T_A	OP-27E, OP-37E			OP-27G, OP-37G			UNIT
			MIN	TYP	MAX	MIN	TYP	MAX	
V_{IO} Input offset voltage	$V_O = 0, V_{IC} = 0$ $R_S = 50 \Omega$, See Note 3	25°C		10	25		30	100	μV
		-25°C to 85°C			50			220	
$\propto V_{IO}$ Average temperature coefficient of input offset voltage		-25°C to 85°C		0.2	0.8		0.4	1.8	$\mu\text{V}/^\circ\text{C}$
Long-term drift of input offset voltage	See Note 4			0.2	1		0.4	2	$\mu\text{V}/\text{mo}$
I_{IO} Input offset current	$V_O = 0, V_{IC} = 0$	25°C		7	35		12	75	nA
		-25°C to 85°C			50			135	
I_{IB} Input bias current	$V_O = 0, V_{IC} = 0$	25°C		± 10	± 40		± 15	± 80	nA
		-25°C to 85°C			± 60			± 150	
V_{ICR} Common-mode input voltage range		25°C		± 11			± 11		V
		-25°C to 85°C			± 10.5			± 10.5	
V_{OM} Peak output voltage swing	$R_L \geq 2 \text{ k}\Omega$ $R_L \geq 0.6 \text{ k}\Omega$ $R_L \geq 2 \text{ k}\Omega$	25°C		± 12	± 13.8		± 11.5	± 13.5	V
				± 10	± 11.5		± 10	± 11.5	
		-25°C to 85°C			± 11.7			± 11	
AVD Large-signal differential voltage amplification	$R_L \geq 2 \text{ k}\Omega, V_O = \pm 10 \text{ V}$ $R_L \geq 1 \text{ k}\Omega, V_O = \pm 10 \text{ V}$ $R_L \geq 0.6 \text{ k}\Omega, V_O = \pm 1 \text{ V}$ $V_{CC} = \pm 4 \text{ V}$ $R_L \geq 2 \text{ k}\Omega, V_O = \pm 10 \text{ V}$	25°C		1000	1800		700	1500	V/mV
				800	1500			1500	
				250	700		200	500	
		-25°C to 85°C			750			450	
$r_{i(CM)}$ Common-mode input resistance				3			2	$\text{G}\Omega$	
r_o Output resistance	$V_O = 0, I_O = 0$	25°C		70			70	Ω	
CMRR Common-mode rejection ratio	$V_{IC} = \pm 11 \text{ V}$ $V_{IC} = \pm 10 \text{ V}$	25°C		114	126		100	120	dB
		-25°C to 85°C			110			96	
kSVR Supply voltage rejection ratio	$V_{CC\pm} = \pm 4 \text{ V}$ to $\pm 18 \text{ V}$ $V_{CC\pm} = \pm 4.5 \text{ V}$ to $\pm 18 \text{ V}$	25°C		100	120		94	118	dB
		-25°C to 85°C			97			90	

NOTES: 3. Input offset voltage measurements are performed by automatic test equipment approximately 0.5 seconds after applying power.
 4. Long-term drift of input offset voltage refers to the average trend line of offset voltage versus time over extended periods after the first 30 days of operation. Excluding the initial hour of operation, changes in V_{IO} during the first 30 days are typically 2.5 μV . See Figure 3.

2 Operational Amplifiers

T-79-06-10 OP-27A, OP-27C, OP-27E, OP-27G
 OP-37A, OP-37C, OP-37E, OP-37G
 LOW-NOISE, HIGH-SPEED, PRECISION OPERATIONAL AMPLIFIERS

OP-27 operating characteristics over operating free-air temperature range, $V_{CC\pm} = \pm 15\text{ V}$

PARAMETER	TEST CONDITIONS	OP-27A, OP-27E			OP-27C, OP-27G			UNIT
		MIN	TYP	MAX	MIN	TYP	MAX	
SR Slew rate at unity gain	$A_{VD} \geq 1, R_L \geq 2\text{ k}\Omega$	1.7	2.8		1.7	2.8		$\text{V}/\mu\text{s}$
V_{NPP} Peak-to-peak equivalent input noise voltage	$f = 0.1\text{ Hz to }10\text{ Hz}, R_S = 100\ \Omega$, See Figure 34		0.08	0.18		0.09	0.25	μV
V_n Equivalent input noise voltage	$f = 10\text{ Hz}, R_S = 100\ \Omega$		3.5	5.5		3.8	8	$\text{nV}/\sqrt{\text{Hz}}$
	$f = 30\text{ Hz}, R_S = 100\ \Omega$		3.1	4.5		3.3	5.6	
	$f = 1\text{ kHz}, R_S = 100\ \Omega$		3.0	3.8		3.2	4.5	
I_n Equivalent input noise current	$f = 10\text{ Hz}$, See Figure 35		1.5	4		1.5		$\text{pA}/\sqrt{\text{Hz}}$
	$f = 30\text{ Hz}$, See Figure 35		1.0	2.3		1.0		
	$f = 1\text{ kHz}$, See Figure 35		0.4	0.6		0.4	0.6	
GBW Gain bandwidth product	$f = 100\text{ kHz}$	5	8		5	8		MHz

2

OP-37 operating characteristics over operating free-air temperature range, $V_{CC\pm} = \pm 15\text{ V}$

PARAMETER	TEST CONDITIONS	OP-37A, OP-37E			OP-37C, OP-37G			UNIT
		MIN	TYP	MAX	MIN	TYP	MAX	
SR Slew rate at unity gain	$A_{VD} \geq 5, R_L \geq 2\text{ k}\Omega$	11	17		11	17		$\text{V}/\mu\text{s}$
V_{NPP} Peak-to-peak equivalent input noise voltage	$f = 0.1\text{ Hz to }10\text{ Hz}, R_S = 100\ \Omega$, See Figure 34		0.08	0.18		0.09	0.25	μV
V_n Equivalent input noise voltage	$f = 10\text{ Hz}, R_S = 100\ \Omega$		3.5	5.5		3.8	8	$\text{nV}/\sqrt{\text{Hz}}$
	$f = 30\text{ Hz}, R_S = 100\ \Omega$		3.1	4.5		3.3	5.6	
	$f = 1\text{ kHz}, R_S = 100\ \Omega$		3.0	3.8		3.2	4.5	
I_n Equivalent input noise current	$f = 10\text{ Hz}$, See Figure 35		1.5	4		1.5		$\text{pA}/\sqrt{\text{Hz}}$
	$f = 30\text{ Hz}$, See Figure 35		1.0	2.3		1.0		
	$f = 1\text{ kHz}$, See Figure 35		0.4	0.6		0.4	0.6	
GBW Gain bandwidth product	$f = 10\text{ kHz}$	45	63		45	63		MHz
	$A_V \geq 5, f = 1\text{ MHz}$		40			40		

Operational Amplifiers

OP-27A, OP-27C, OP-27E, OP-27G
 OP-37A, OP-37C, OP-37E, OP-37G
 LOW-NOISE, HIGH-SPEED, PRECISION OPERATIONAL AMPLIFIERS T-79-06-10

TYPICAL CHARACTERISTICS

table of graphs

			FIGURE
V_{IO}	Input offset voltage	vs Temperature	1
ΔV_{IO}	Change in input offset voltage	vs Time after power-on	2
		vs Time (long-term drift)	3
I_{IO}	Input offset current	vs Temperature	4
I_{IB}	Input bias current	vs Temperature	5
V_{ICR}	Common-mode input voltage range	vs Supply voltage	6
V_{OM}	Maximum peak output voltage	vs Load resistance	7
V_{OPP}	Maximum peak-to-peak output voltage	vs Frequency	8, 9
A_{VD}	Differential voltage amplification	vs Supply voltage	10
		vs Load resistance	11
		vs Frequency	12, 13, 14
CMRR	Common-mode rejection ratio	vs Frequency	15
k_{SVR}	Supply voltage rejection ratio	vs Frequency	16
SR	Slew rate	vs Temperature	17
		vs Supply voltage	18
		vs Load resistance	19
ϕ_m	Phase margin	vs Temperature	20, 21
ϕ	Phase shift	vs Frequency	12, 13
		vs Bandwidth	22
V_n	Equivalent input noise voltage	vs Source resistance	23
		vs Supply voltage	24
		vs Temperature	25
		vs Frequency	26
		vs Frequency	27
I_n	Equivalent input noise current	vs Frequency	27
GBW	Gain bandwidth product	vs Temperature	20, 21
I_{OS}	Short-circuit output current	vs Time	28
I_{CC}	Supply current	vs Supply voltage	29
	Pulse response	Small-signal	30, 32
		Large-signal	31, 33

2
Operational Amplifiers

TYPICAL CHARACTERISTICS†

T-79-06-10

INPUT OFFSET VOLTAGE OF REPRESENTATIVE UNIT VS FREE-AIR TEMPERATURE

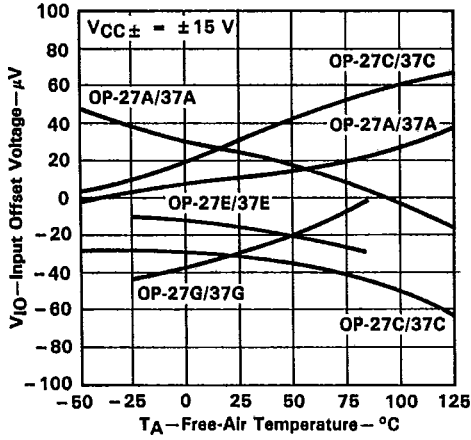

FIGURE 1

WARM-UP CHANGE IN INPUT OFFSET VOLTAGE VS ELAPSED TIME

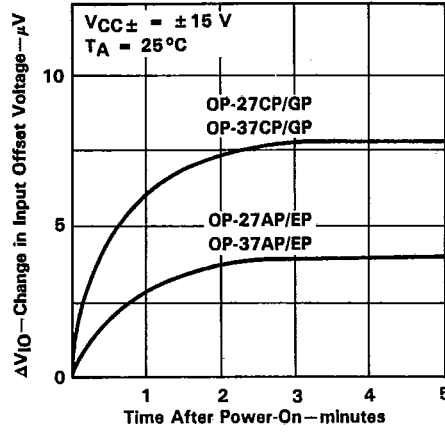

FIGURE 2

LONG-TERM DRIFT OF INPUT OFFSET VOLTAGE OF REPRESENTATIVE UNITS

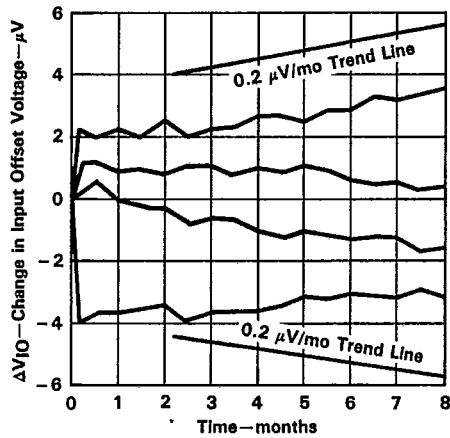

FIGURE 3

2
Operational Amplifiers

†Data for temperatures below -25°C and above 85°C are applicable to the OP-27A, OP-27C, OP-37A, and OP-37C only.

TYPICAL CHARACTERISTICS†

2 Operational Amplifiers

INPUT OFFSET CURRENT
 vs
 FREE-AIR TEMPERATURE

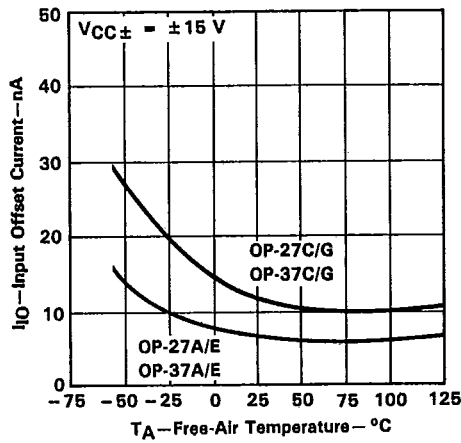

FIGURE 4

INPUT BIAS CURRENT
 vs
 FREE-AIR TEMPERATURE

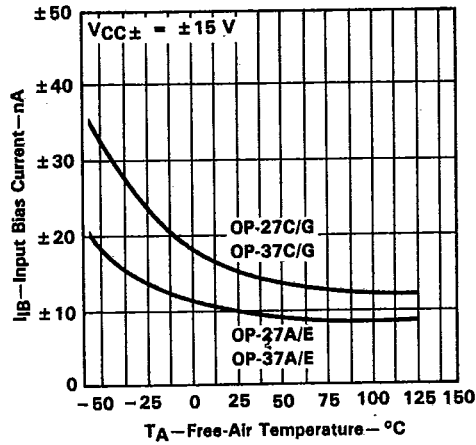

FIGURE 5

COMMON-MODE INPUT VOLTAGE RANGE LIMITS
 vs
 SUPPLY VOLTAGE

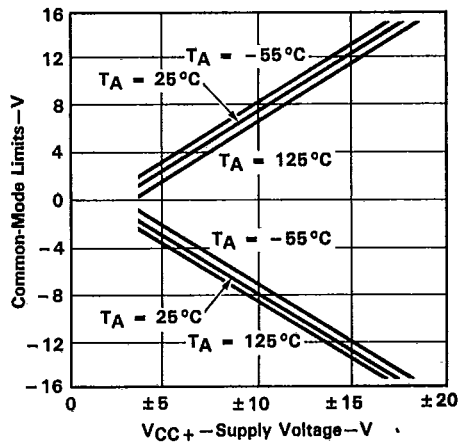

FIGURE 6

MAXIMUM PEAK OUTPUT VOLTAGE
 vs
 LOAD RESISTANCE

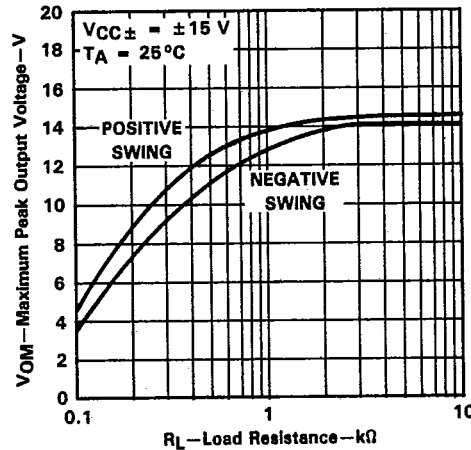

FIGURE 7

†Data for temperatures below -25°C and above 85°C are applicable to the OP-27A, OP-27C, OP-37A, and OP-37C only.

TYPICAL CHARACTERISTICS

T-79-06-10

OP-27
MAXIMUM PEAK-TO-PEAK
OUTPUT VOLTAGE
vs
FREQUENCY

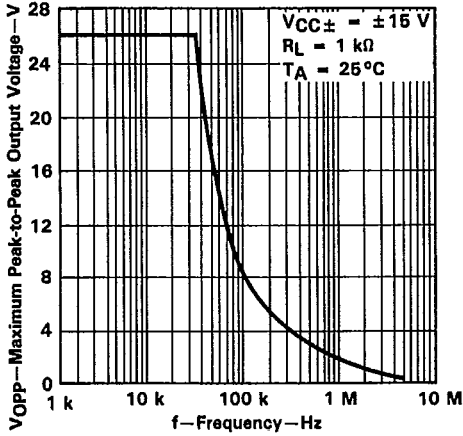

FIGURE 8

OP-37
MAXIMUM PEAK-TO-PEAK
OUTPUT VOLTAGE
vs
FREQUENCY

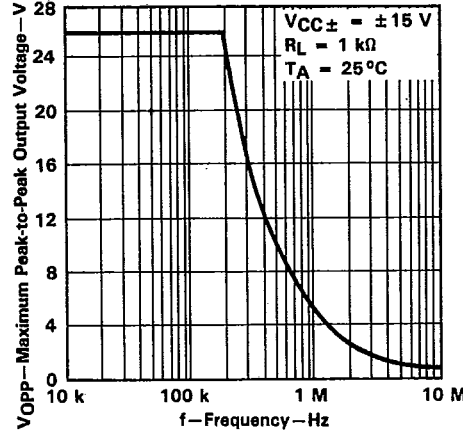

FIGURE 9

2
Operational Amplifiers

OP-27A, OP-27E, OP-37A, OP-37E
LARGE-SIGNAL
DIFFERENTIAL VOLTAGE AMPLIFICATION
vs
TOTAL SUPPLY VOLTAGE

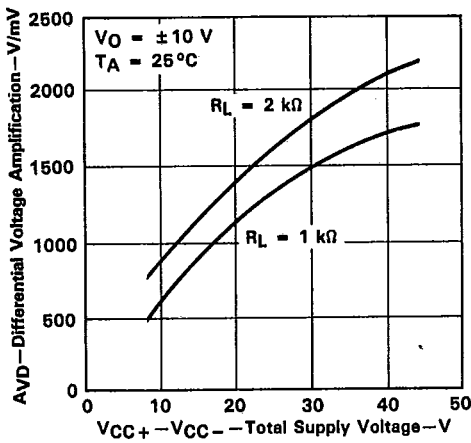

FIGURE 10

OP-27A, OP-27E, OP-37A, OP-37E
LARGE-SIGNAL
DIFFERENTIAL VOLTAGE AMPLIFICATION
vs
LOAD RESISTANCE

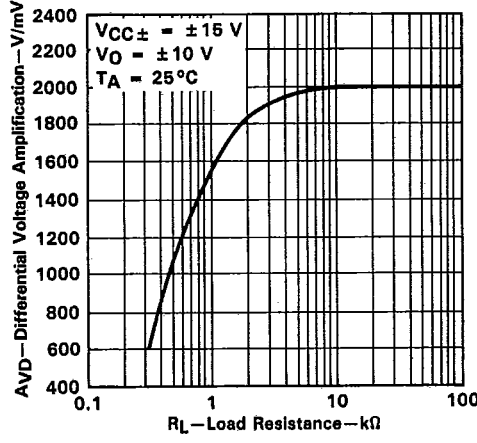

FIGURE 11

TYPICAL CHARACTERISTICS

OP-27
 LARGE-SIGNAL DIFFERENTIAL
 VOLTAGE AMPLIFICATION AND PHASE SHIFT
 vs
 FREQUENCY

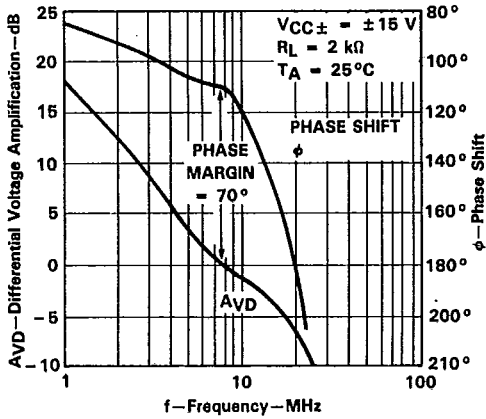

FIGURE 12

OP-37
 LARGE-SIGNAL DIFFERENTIAL
 VOLTAGE AMPLIFICATION AND PHASE SHIFT
 vs
 FREQUENCY

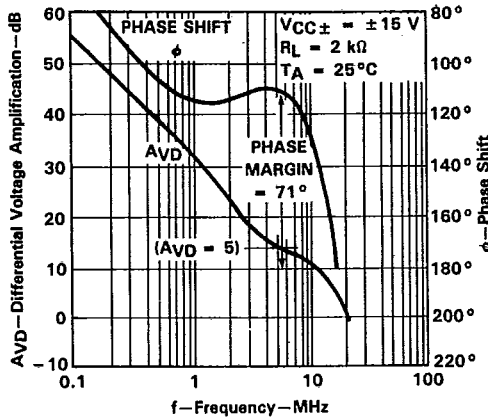

FIGURE 13

OP-27A, OP-27E, OP-37A, OP-37E
 LARGE-SIGNAL
 DIFFERENTIAL VOLTAGE AMPLIFICATION
 vs
 FREQUENCY

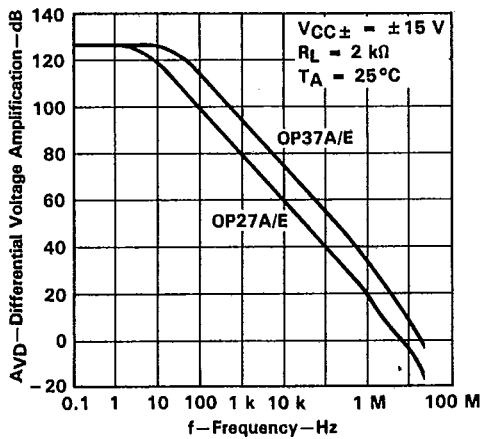

FIGURE 14

OP-27A, OP-27E, OP-37A, OP-37E
 COMMON-MODE REJECTION RATIO
 vs
 FREQUENCY

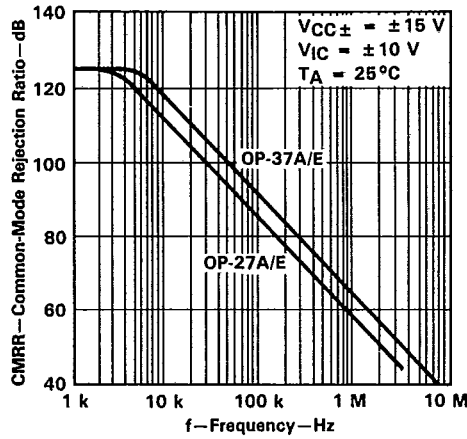

FIGURE 15

TYPICAL CHARACTERISTICS†

T-79-06-10

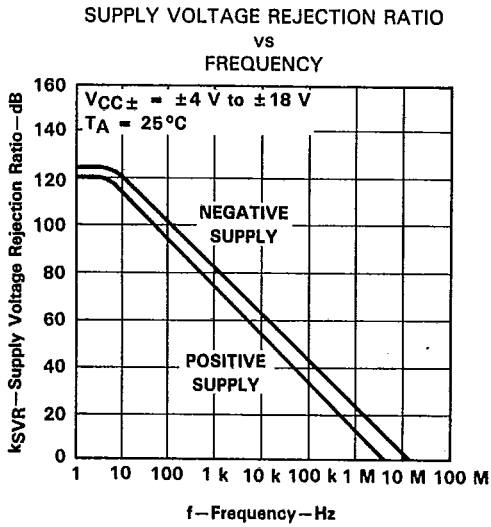

FIGURE 16

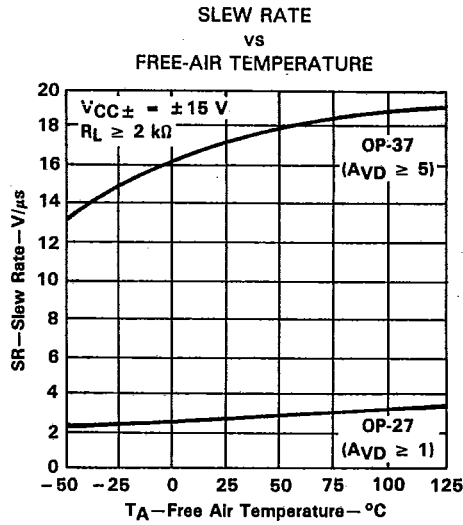

FIGURE 17

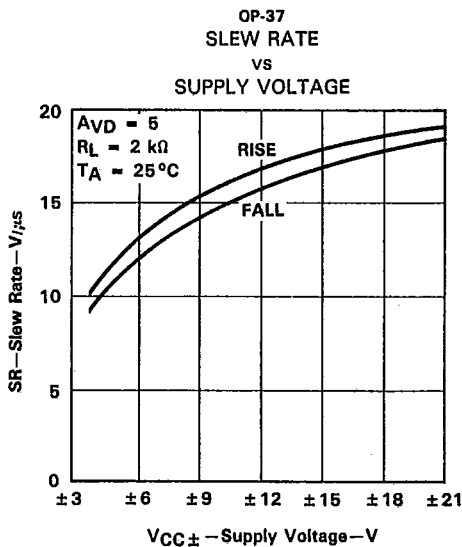

FIGURE 18

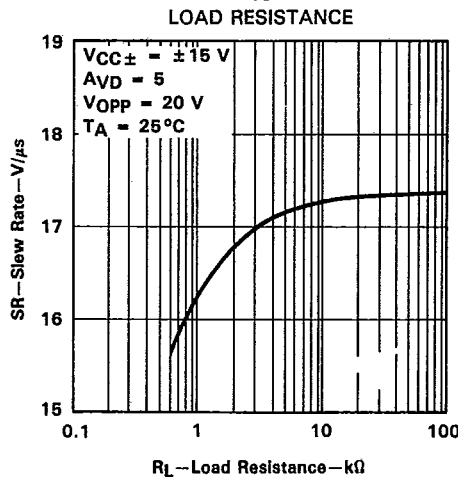

FIGURE 19

2
Operational Amplifiers

†Data for temperatures below -25°C and above 85°C are applicable to the OP-27A, OP-27C, OP-37A, and OP-37C only.

OP-27A, OP-27C, OP-27E, OP-27G
 OP-37A, OP-37C, OP-37E, OP-37G
 LOW-NOISE, HIGH-SPEED, PRECISION OPERATIONAL AMPLIFIERS

T-79-06-10

TYPICAL CHARACTERISTICS†

OP-27
 PHASE MARGIN AND
 GAIN-BANDWIDTH PRODUCT
 VS
 FREE-AIR TEMPERATURE

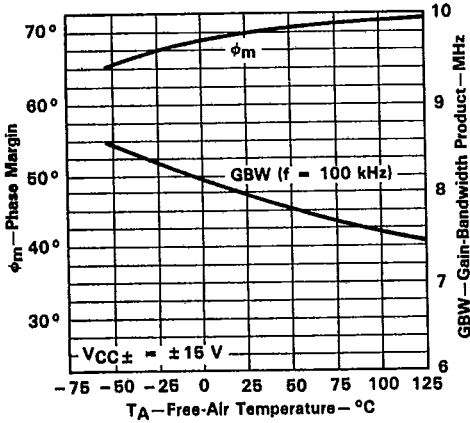

FIGURE 20

EQUIVALENT INPUT NOISE VOLTAGE
 VS
 BANDWIDTH

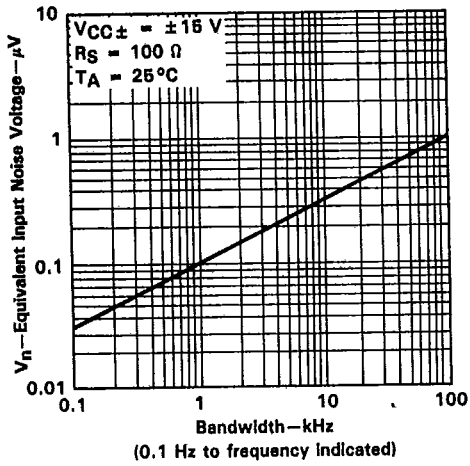

FIGURE 22

OP-37
 PHASE MARGIN AND
 GAIN-BANDWIDTH PRODUCT
 VS
 FREE-AIR TEMPERATURE

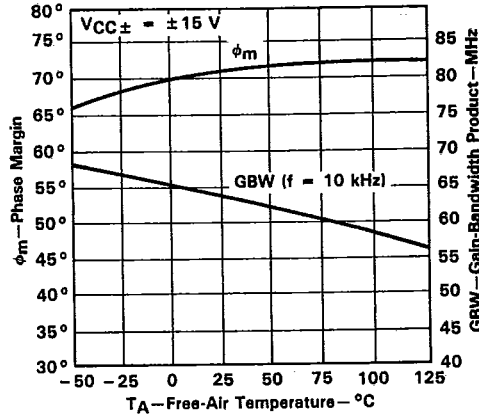

FIGURE 21

TOTAL EQUIVALENT INPUT NOISE VOLTAGE
 VS
 SOURCE RESISTANCE

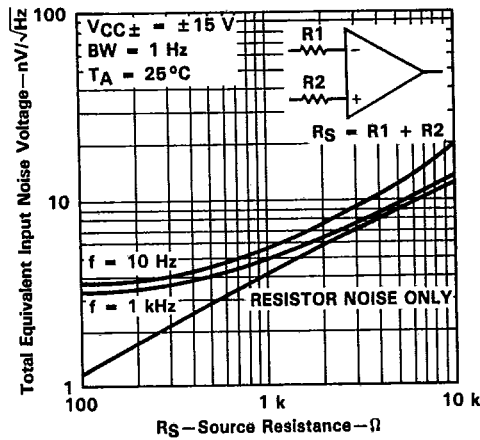

FIGURE 23

†Data for temperatures below -25°C and above 85°C are applicable to the OP-27A, OP-27C, OP-37A, and OP-37C only.

2
 Operational Amplifiers

LOW-NOISE, HIGH-SPEED, PRECISION OPERATIONAL AMPLIFIERS

TYPICAL CHARACTERISTICS†

T-79-06-10

OP-27A, OP-27E, OP-37A, OP-37E
EQUIVALENT INPUT NOISE VOLTAGE
vs
TOTAL SUPPLY VOLTAGE

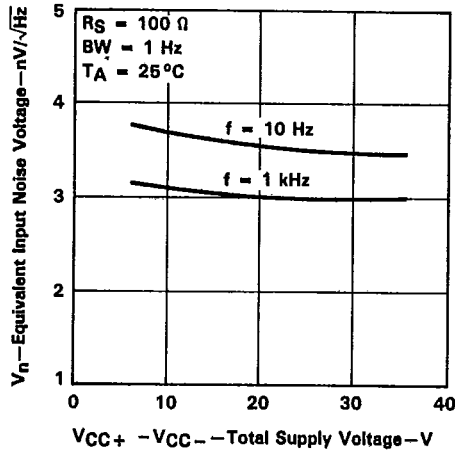

FIGURE 24

OP-27A, OP-27E, OP-37A, OP-37E
EQUIVALENT INPUT NOISE VOLTAGE
vs
FREE-AIR TEMPERATURE

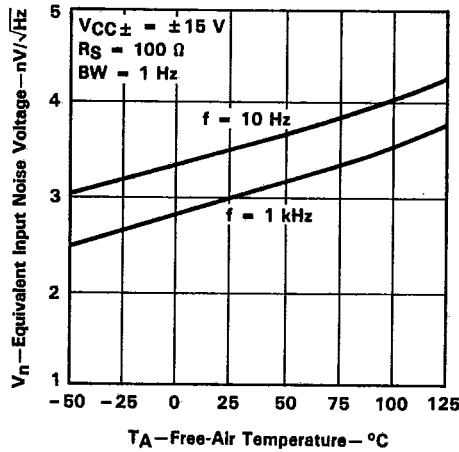

FIGURE 25

OP-27A, OP-27E, OP-37A, OP-37E
EQUIVALENT INPUT NOISE VOLTAGE
vs
FREQUENCY

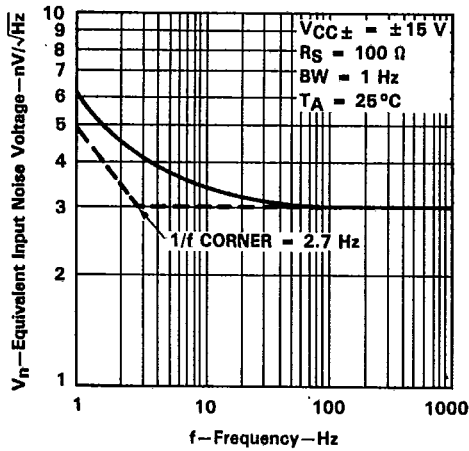

FIGURE 26

EQUIVALENT INPUT NOISE CURRENT
vs
FREQUENCY

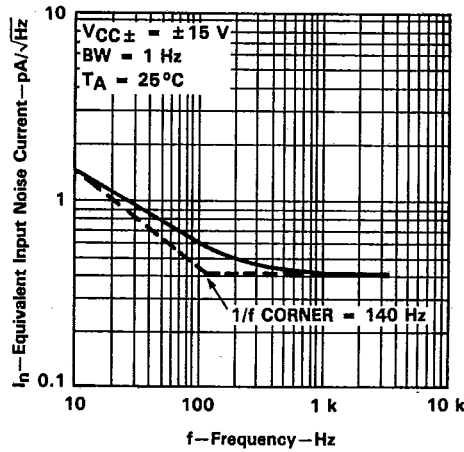

FIGURE 27

†Data for temperatures below -25 °C and above 85 °C are applicable to the OP-27A, OP-27C, OP-37A, and OP-37C only.

2

Operational Amplifiers

TYPICAL CHARACTERISTICS†

SHORT-CIRCUIT OUTPUT CURRENT
 vs
 ELAPSED TIME

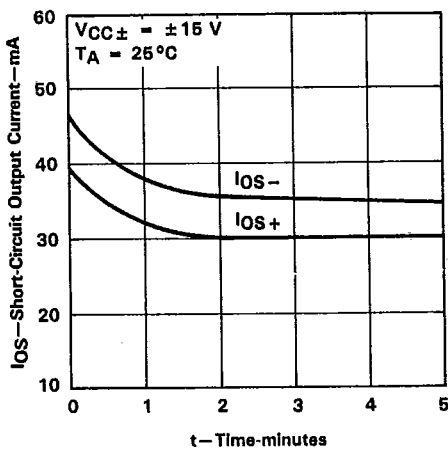

FIGURE 28

SUPPLY CURRENT
 vs
 TOTAL SUPPLY VOLTAGE

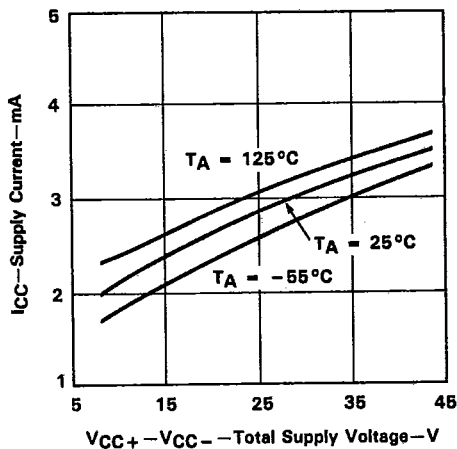

FIGURE 29

OP-27
 VOLTAGE FOLLOWER
 SMALL-SIGNAL
 PULSE RESPONSE

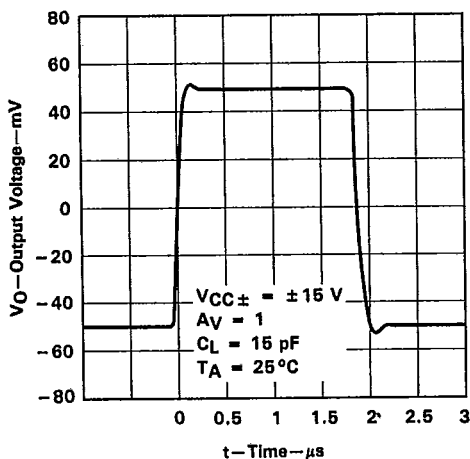

FIGURE 30

OP-27
 VOLTAGE FOLLOWER
 LARGE-SIGNAL
 PULSE RESPONSE

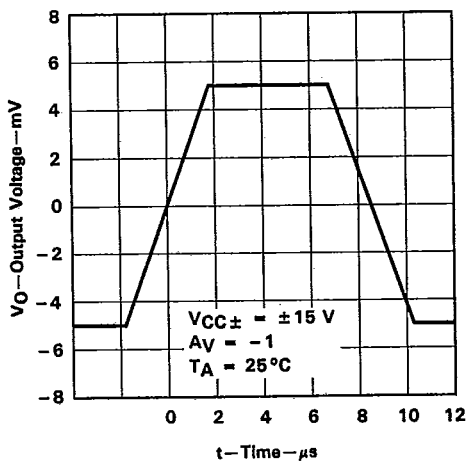

FIGURE 31

†Data for temperatures below -25°C and above 85°C are applicable to the OP-27A, OP-27C, OP-37A, and OP-37C only.

LOW-NOISE, HIGH-SPEED, PRECISION OPERATIONAL AMPLIFIERS

TYPICAL CHARACTERISTICS

T-79-06-10

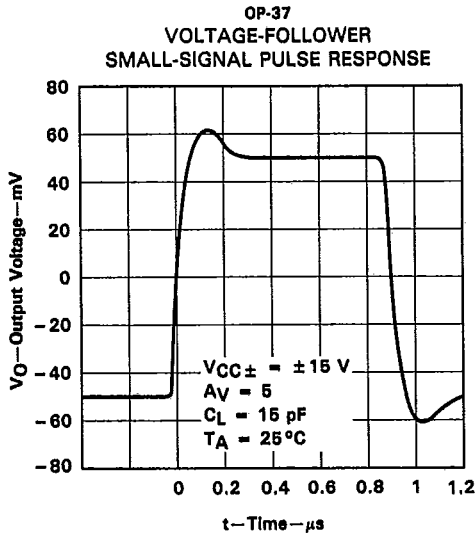

FIGURE 32

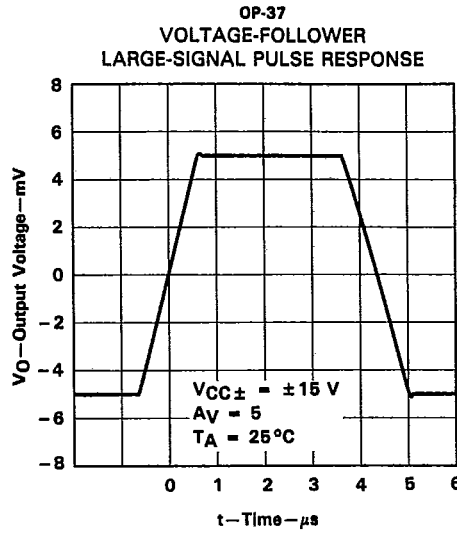

FIGURE 33

2
Operational Amplifiers

TYPICAL APPLICATION DATA

general

The OP-27 and OP-37 series devices may be inserted directly into OP-07, OP-05, μ A725, and SE5534 sockets with or without removing external compensation or nulling components. In addition, the OP-27 and OP-37 may be fitted to μ A741 sockets by removing or modifying external nulling components.

noise testing

Figure 34 shows a test circuit for 0.1-Hz to 10-Hz peak-to-peak noise measurement of the OP-27 and OP-37. The frequency response of this noise tester indicates that the 0.1-Hz corner is defined by only one zero. Because the time limit acts as an additional zero to eliminate noise contributions from the frequency band below 0.1 Hz, the test time to measure 0.1-Hz to 10-Hz noise should not exceed 10 seconds.

TYPICAL APPLICATION DATA

T-79-06-10

When measuring noise on a large number of units, a noise-voltage density test is recommended. A 10-Hz noise-voltage density measurement correlates well with a 0.1-Hz to 10-Hz peak-to-peak noise reading since both results are determined by the white noise and the location of the 1/f corner frequency.

Figure 35 shows a circuit measuring current noise and the formula for calculating current noise.

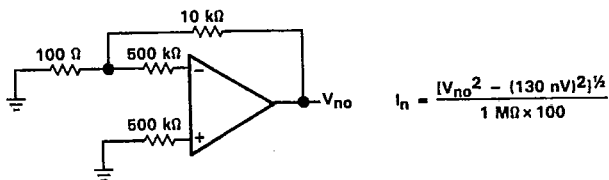

FIGURE 35. CURRENT NOISE TEST CIRCUIT AND FORMULA

offset voltage adjustment

The input offset voltage and temperature coefficient of the OP-27 and OP-37 are permanently trimmed to a low level at wafer testing. However, if further adjustment of V_{IO} is necessary, using a 10-k Ω nulling potentiometer, as shown in Figure 36, does not degrade the temperature coefficient $\propto V_{IO}$. Trimming to a value other than zero creates an $\propto V_{IO}$ of $V_{IO}/300 \mu\text{V}/^\circ\text{C}$. For example, if V_{IO} is adjusted to 300 μV , the change in $\propto V_{IO}$ is 1 $\mu\text{V}/^\circ\text{C}$.

The adjustment range with a 10-k Ω potentiometer is approximately $\pm 2.5 \text{ mV}$. If a smaller adjustment range is needed, the sensitivity and resolution of the nulling can be improved by using a smaller potentiometer in conjunction with fixed resistors. The example in Figure 37 has an approximate null range of $\pm 200 \mu\text{V}$.

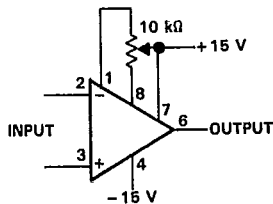

FIGURE 36. STANDARD INPUT OFFSET VOLTAGE ADJUSTMENT

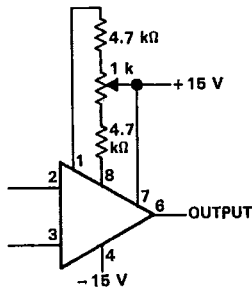

FIGURE 37. INPUT OFFSET VOLTAGE ADJUSTMENT WITH IMPROVED SENSITIVITY

offset voltage and drift

Unless proper care is exercised, thermocouple effects caused by temperature gradients across dissimilar metals at the contacts to the input terminals can exceed the inherent temperature coefficient $\propto V_{IO}$ of the amplifier. Air currents should be minimized, package leads should be short, and the two input leads should be close together and at the same temperature.

The circuit shown in Figure 38 measures offset voltage. This circuit can also be used as the burn-in configuration for the OP-27 and OP-37, with the supply voltage increased to $\pm 20 \text{ V}$, $R_1 = R_3 = 10 \text{ k}\Omega$, $R_2 = 200 \Omega$, and $A_{VP} = 100$.

2 Operational Amplifiers

TYPICAL APPLICATION DATA

noise testing (continued)

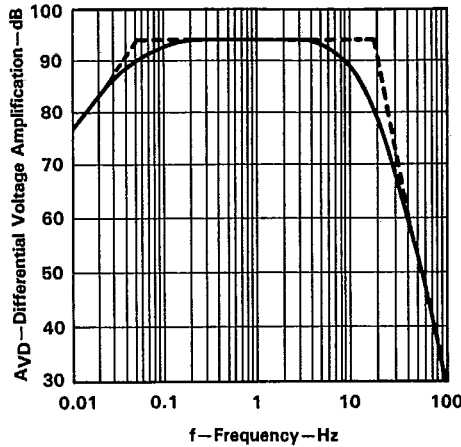

2
Operational Amplifiers

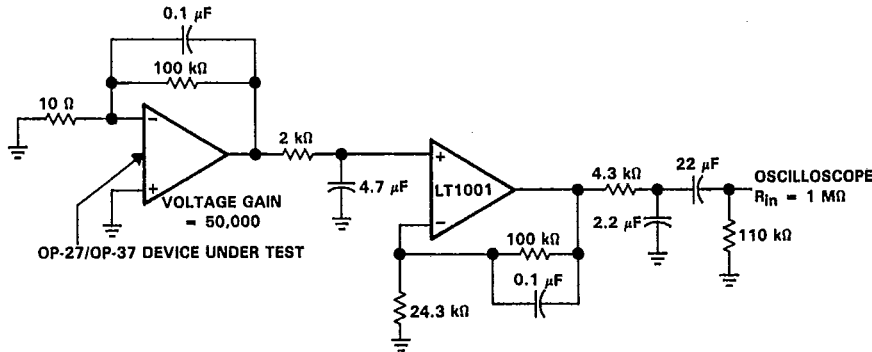

NOTE: All capacitor values are for non-polarized capacitors only.

FIGURE 34. 0.1-Hz TO 10-Hz PEAK-TO-PEAK NOISE TEST CIRCUIT AND FREQUENCY RESPONSE

Measuring the typical 80-nV peak-to-peak noise performance of the OP-27 and OP-37 requires the following special test precautions:

1. The device should be warmed up for at least five minutes. As the operational amplifier warms up, the offset voltage typically changes 4 μ V due to the chip temperature increasing from 10 $^{\circ}$ C to 20 $^{\circ}$ C starting from the moment the power supplies are turned on. In the 10-s measurement interval, these temperature-induced effects can easily exceed tens of nanovolts.
2. For similar reasons, the device should be well shielded from air currents to eliminate the possibility of thermoelectric effects in excess of a few nanovolts, which would invalidate the measurements.
3. Sudden motion in the vicinity of the device should be avoided, as it produces a feedthrough effect that increases observed noise.

TYPICAL APPLICATION DATA

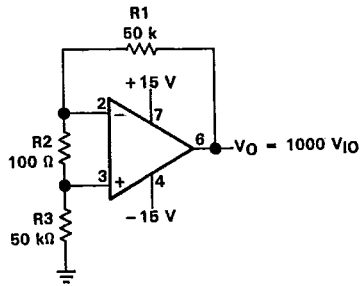

NOTE: Resistors must have low thermoelectric potential.

FIGURE 38. TEST CIRCUIT FOR OFFSET VOLTAGE AND OFFSET VOLTAGE TEMPERATURE COEFFICIENT

unity gain buffer applications

The resulting output waveform when $R_f \leq 100 \Omega$ and the input is driven with a fast large-signal pulse ($> 1 \text{ V}$) is shown in the pulsed-operation diagram in Figure 39.

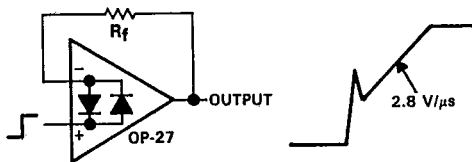
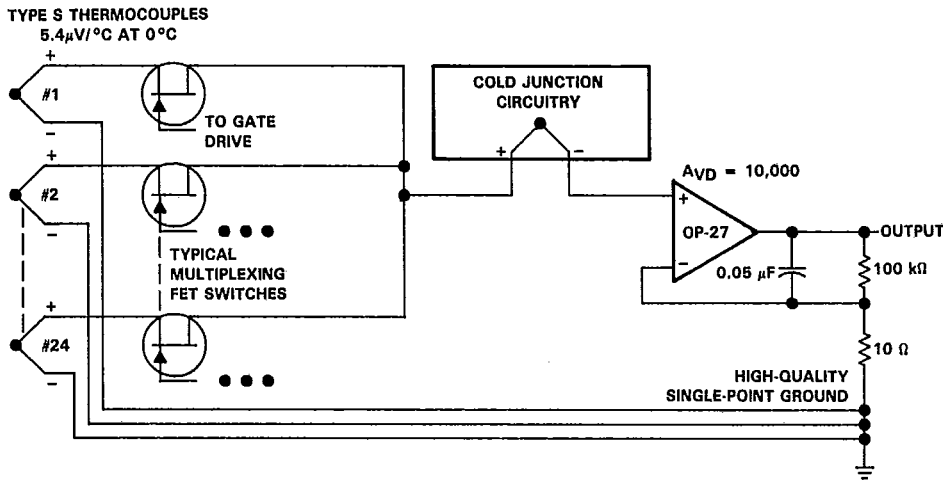
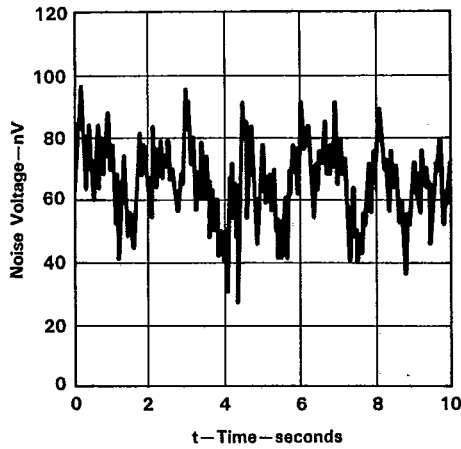

FIGURE 39. PULSED OPERATION

During the initial (fast-feedthrough-like) portion of the output waveform, the input protection diodes effectively short the output to the input, and a current, limited only by the output short-circuit protection, is drawn by the signal generator. When $R_f \geq 500 \Omega$, the output is capable of handling the current requirements (load current $\leq 20 \text{ mA}$ at 10 V), the amplifier stays in its active mode, and a smooth transition occurs. When $R_f > 2 \text{ k}\Omega$, a pole is created with R_f and the amplifier's input capacitance, creating additional phase shift and reducing the phase margin. A small capacitor (20 pF to 50 pF) in parallel with R_f eliminates this problem.

TYPICAL APPLICATION

T-79-06-10



NOTE A: If 24 channels are multiplexed per second, and the output is required to settle to 0.1% accuracy, the amplifier's bandwidth cannot be limited to less than 30 Hz. The peak-to-peak noise contribution of the OP-27 will still be only 0.11 μ V, which is equivalent to an error of only 0.02°C.

FIGURE 40. LOW-NOISE, MULTIPLEXED THERMOCOUPLE AMPLIFIER AND 0.1-Hz TO 10-Hz PEAK-TO-PEAK NOISE VOLTAGE

2
Operational Amplifiers