

- 250-V Phototriac Driver Output
- Gallium-Arsenide-Diode Infrared Source and Optically-Coupled Silicon Triac Driver (Bilateral Switch)
- UL Recognized . . . File Number E65085
- High Isolation . . . 3535 V peak
- Output Driver Designed for 115 Vac
- Standard 6-Pin Plastic DIP

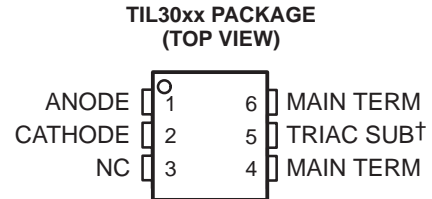

† Do not connect this terminal
NC – No internal connection

typical 115 Vac(rms) applications

- Solenoid/Valve Controls
- Lamp Ballasts
- Interfacing Microprocessors to 115-Vac Peripherals
- Motor Controls
- Incandescent Lamp Dimmers

logic diagram

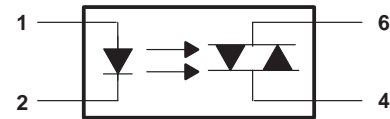

description

Each device consists of a gallium-arsenide infrared-emitting diode optically coupled to a silicon phototriac mounted on a 6-pin lead frame encapsulated within an electrically nonconductive plastic compound. The case withstands soldering temperature with no deformation. Device performance characteristics remain stable when operated in high-humidity conditions.

absolute maximum ratings at 25°C free-air (unless otherwise noted)†

Input-to-output peak voltage, 5 s maximum duration, 60 Hz (see Note 1)	3.535 kV
Input diode reverse voltage	3 V
Input diode forward current, continuous	50 mA
Output repetitive peak off-state voltage	250 V
Output on-state current, total rms value (50-60 Hz, full sine wave): $T_A = 25^\circ$	100 mA
$T_A = 70^\circ$	50 mA
Output driver nonrepetitive peak on-state current ($t_W = 10$ ms, duty cycle = 10%, see Figure 7)	1.2 A
Continuous power dissipation at (or below) 25°C free-air temperature:	
Infrared-emitting diode (see Note 2)	100 mW
Phototriac (see Note 3)	300 mW
Total device (see Note 4)	330 mW
Operating junction temperature range, T_J	-40°C to 100°C
Storage temperature range, T_{stg}	-40°C to 150°C
Lead temperature 1,6 mm (1/16 inch) from case for 10 seconds	260°C

† Stresses beyond those listed under "absolute maximum ratings" may cause permanent damage to the device. These are stress ratings only, and functional operation of the device at these or any other conditions beyond those indicated under "recommended operating conditions" is not implied. Exposure to absolute-maximum-rated conditions for extended periods may affect device reliability.

- NOTES:
1. Input-to-output peak voltage is the internal device dielectric breakdown rating.
 2. Derate linearly to 100°C free-air temperature at the rate of 1.33 mW/°C.
 3. Derate linearly to 100°C free-air temperature at the rate of 4 mW/°C.
 4. Derate linearly to 100°C free-air temperature at the rate of 4.4 mW/°C.

TIL3009, TIL3010, TIL3011, TIL3012 OPTOCOUPLEDERS/OPTOISOLATORS

SOES027A – DECEMBER 1987 – REVISED APRIL 1998

electrical characteristics 25°C free-air temperature range (unless otherwise noted)

PARAMETER		TEST CONDITIONS	MIN	TYP	MAX	UNIT
I_R	Static reverse current	$V_R = 3\text{ V}$		0.05	100	μA
V_F	Static forward voltage	$I_F = 10\text{ mA}$		1.2	1.5	V
I_{DRM}	Repetitive off-state current, either direction	$V_{DRM} = 250\text{ V}$, See Note 5		10	100	nA
dv/dt	Critical rate of rise of off-state voltage	See Figure 1		12		V/ μs
dv/dt(c)	Critical rate of rise of commutating voltage	$I_O = 15\text{ mA}$, See Figure 1		0.15		V/ μs
I_{FT}	Input trigger current either direction	Output supply voltage = 3 V	TIL3009	15	30	mA
			TIL3010	8	15	
			TIL3011	5	10	
			TIL3012		5	
V_{TM}	Peak on-state voltage, either direction	$I_{TM} = 100\text{ mA}$		1.8	3	V
I_H	Holding current, either direction			100		μA

NOTE 5: Test voltage must be applied within dv/dt rating.

PARAMETER MEASUREMENT INFORMATION

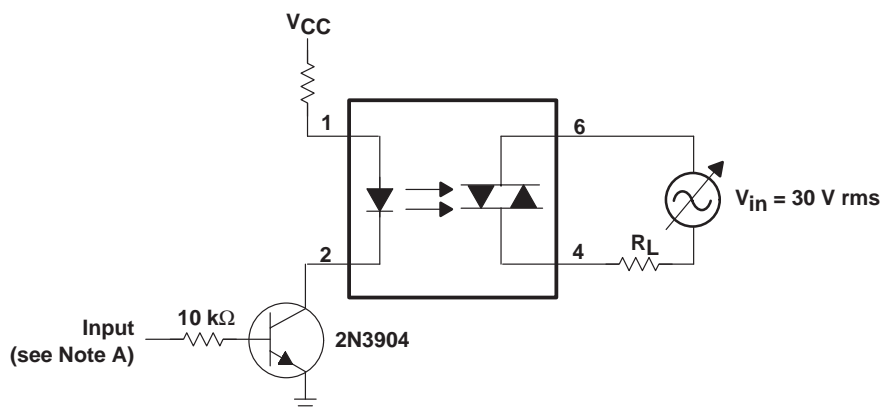

NOTE A. The critical rate of rise of off-state voltage, dv/dt, is measured with the input set at 0 volts. The frequency of V_{in} is increased until the phototriac turns on. This frequency is then used to calculate the dv/dt according to the following formula:

$$dv/dt = 2\sqrt{2}\pi f V_{in}$$

The critical rate of rise of commutating voltage, dv/dt(c), is measured by applying occasional 5-volt pulses to the input and increasing the frequency of V_{in} until the phototriac remains on (latches) after the input pulse has ceased. With no further input pulses, the frequency of V_{in} is then gradually decreased until the phototriac turns off. The frequency at which turn-off occurs can then be used to calculate the dv/dt(c) according to the formula shown above.

Figure 1. Critical Rate of Rise Test Circuit

TYPICAL CHARACTERISTICS

EMITTING DIODE TRIGGER CURRENT (NORMALIZED)
vs
FREE-AIR TEMPERATURE

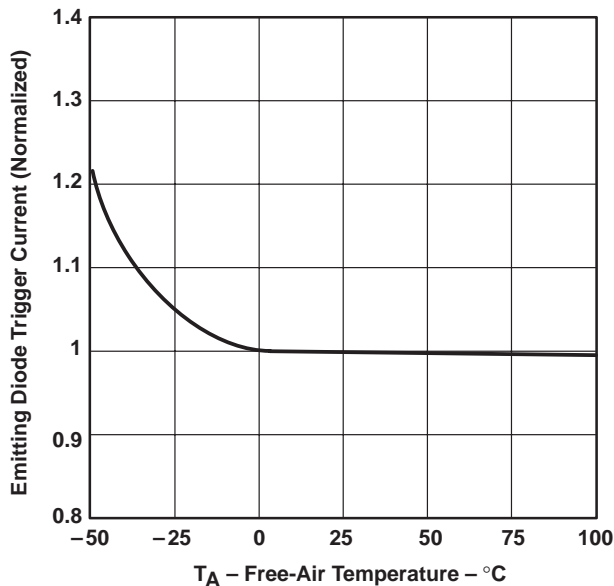

Figure 2

ON-STATE CHARACTERISTICS

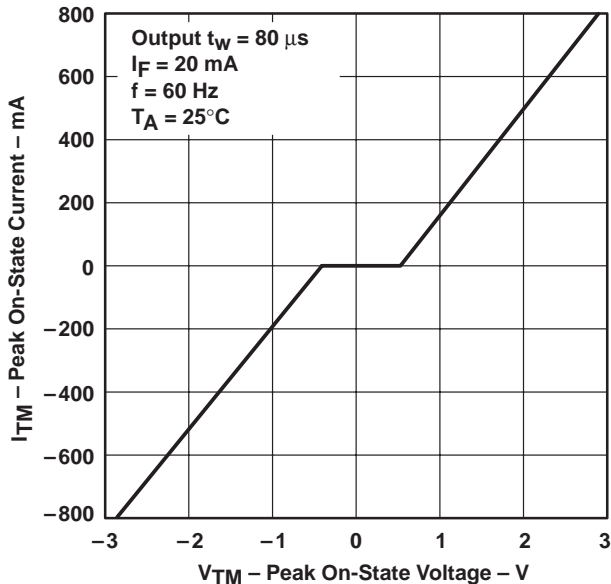

Figure 3

CRITICAL RATE OF RISE OF OUTPUT VOLTAGE
OFF-STATE dv/dt AND COMMUTATING dv/dt(c)
vs
LOAD RESISTANCE

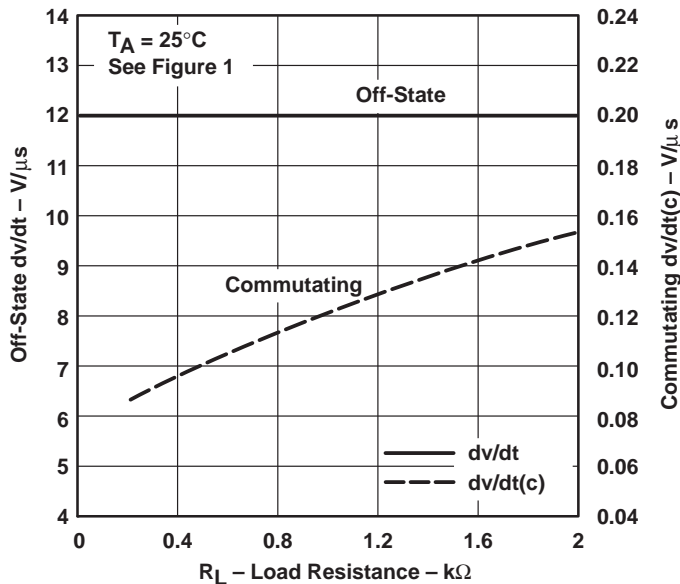

Figure 4

TYPICAL CHARACTERISTICS

OFF-STATE dv/dt AND COMMUTATING dv/dt
vs
FREE-AIR TEMPERATURE

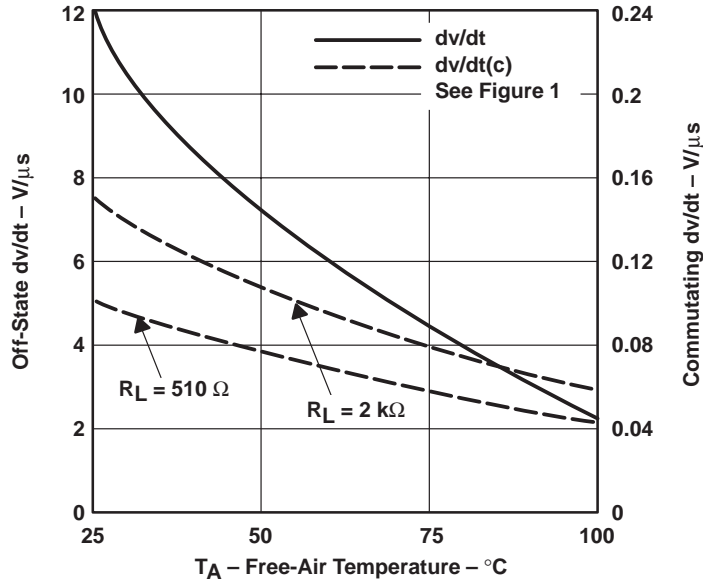

Figure 5

RMS APPLIED VOLTAGE
(FOR $dv/dt(c) = 0.15 V/\mu s$)
vs
FREQUENCY

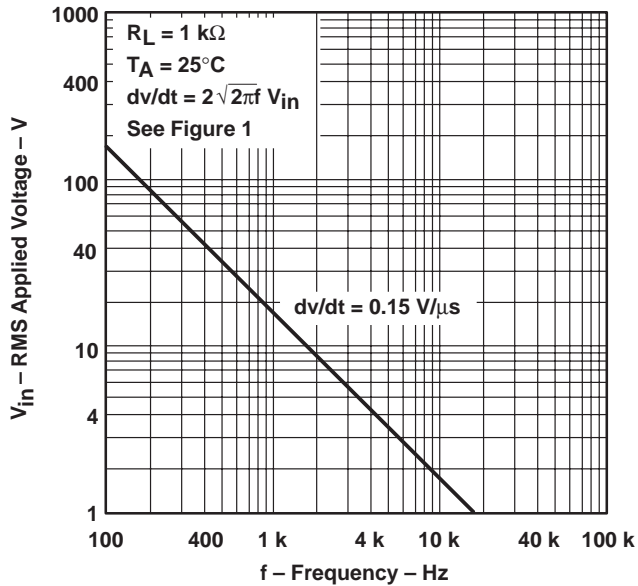

Figure 6

NONREPETITIVE PEAK ON-STATE CURRENT
vs
PULSE DURATION

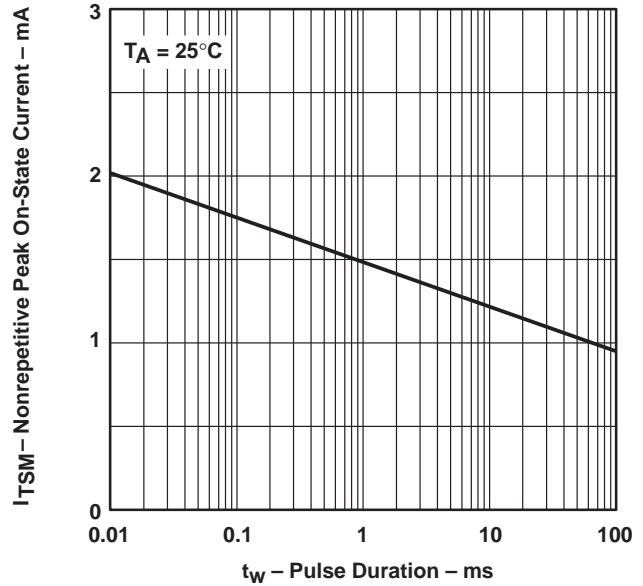

Figure 7

APPLICATION INFORMATION

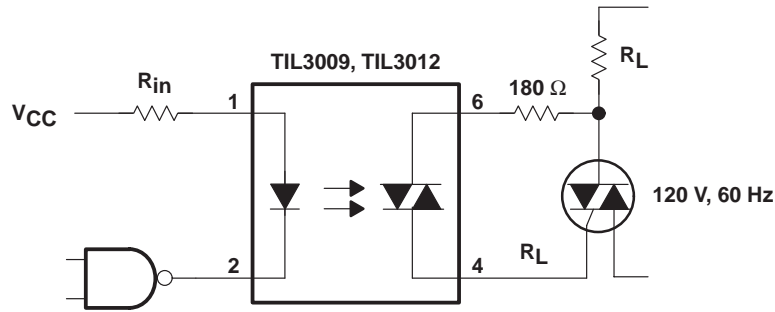

Figure 8. Resistive Load

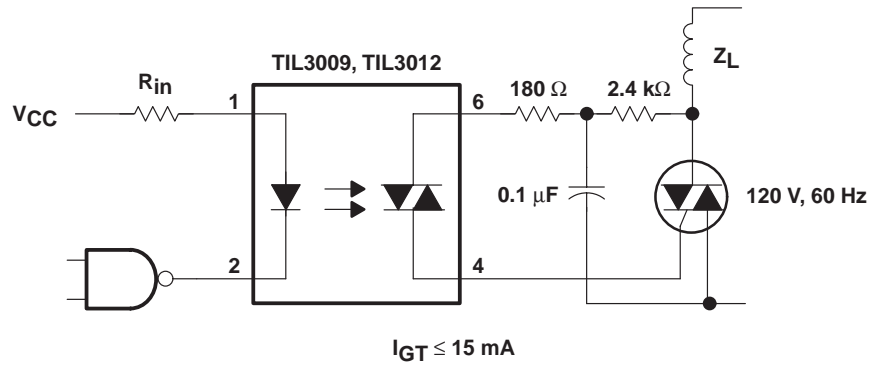

Figure 9. Inductive Load With Sensitive-Gate Triac

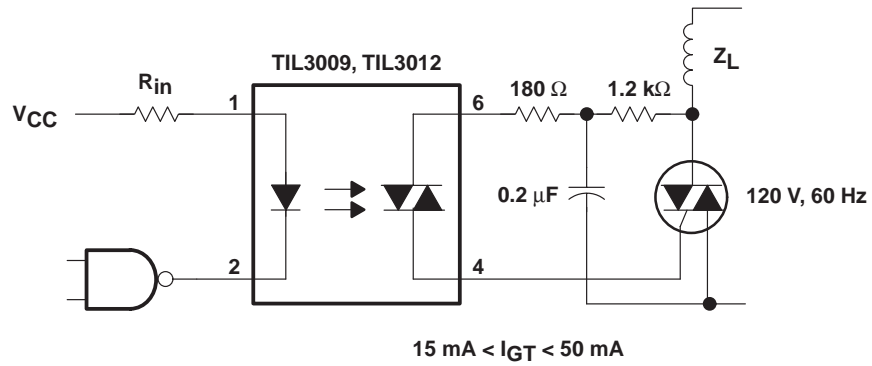
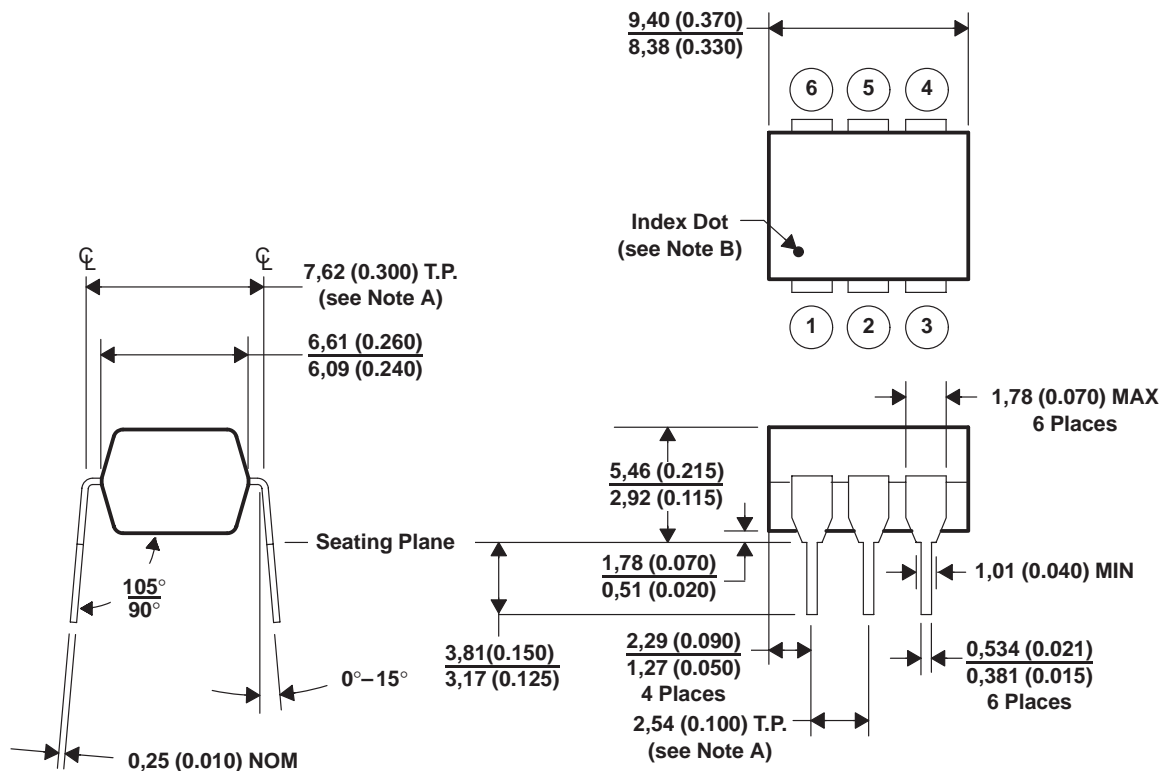

Figure 10. Inductive Load With Nonsensitive-Gate Triac

MECHANICAL INFORMATION



- NOTES: A. Leads are within 0,13 mm (0.005 inch) radius of true position (T.P.) with maximum material condition and unit installed.
 B. Pin 1 identified by index dot.
 C. The dimensions given fall within JEDEC MO-001 AM dimensions.
 D. All linear dimensions are given in millimeters and parenthetically given in inches.

Figure 11. Packaging Specifications

IMPORTANT NOTICE

Texas Instruments and its subsidiaries (TI) reserve the right to make changes to their products or to discontinue any product or service without notice, and advise customers to obtain the latest version of relevant information to verify, before placing orders, that information being relied on is current and complete. All products are sold subject to the terms and conditions of sale supplied at the time of order acknowledgement, including those pertaining to warranty, patent infringement, and limitation of liability.

TI warrants performance of its semiconductor products to the specifications applicable at the time of sale in accordance with TI's standard warranty. Testing and other quality control techniques are utilized to the extent TI deems necessary to support this warranty. Specific testing of all parameters of each device is not necessarily performed, except those mandated by government requirements.

CERTAIN APPLICATIONS USING SEMICONDUCTOR PRODUCTS MAY INVOLVE POTENTIAL RISKS OF DEATH, PERSONAL INJURY, OR SEVERE PROPERTY OR ENVIRONMENTAL DAMAGE ("CRITICAL APPLICATIONS"). TI SEMICONDUCTOR PRODUCTS ARE NOT DESIGNED, AUTHORIZED, OR WARRANTED TO BE SUITABLE FOR USE IN LIFE-SUPPORT DEVICES OR SYSTEMS OR OTHER CRITICAL APPLICATIONS. INCLUSION OF TI PRODUCTS IN SUCH APPLICATIONS IS UNDERSTOOD TO BE FULLY AT THE CUSTOMER'S RISK.

In order to minimize risks associated with the customer's applications, adequate design and operating safeguards must be provided by the customer to minimize inherent or procedural hazards.

TI assumes no liability for applications assistance or customer product design. TI does not warrant or represent that any license, either express or implied, is granted under any patent right, copyright, mask work right, or other intellectual property right of TI covering or relating to any combination, machine, or process in which such semiconductor products or services might be or are used. TI's publication of information regarding any third party's products or services does not constitute TI's approval, warranty or endorsement thereof.