

AT78L05TI

3-Terminal Positive Voltage Regulator

Features

- ◆ Input voltage: up to 30V
- ◆ Output: 5V
- ◆ Output current up to 100 mA, internal thermal overload protection and short-circuit limiting.

Marking: 78L05

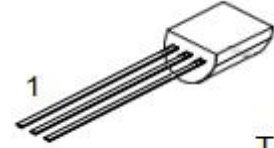

TO-92

1. OUT 2. GND 3. IN

Maximum Ratings

Ratings at $T_A = 25^\circ\text{C}$ ambient temperature unless otherwise specified.

Parameter	Symbols	Value	Units
Input Voltage	V_I	30	V
Output Current	I_O	100	mA
Junction Temperature	T_J	125	$^\circ\text{C}$
Operating Temperature	T_{OPR}	-40~125	$^\circ\text{C}$
Storage Temperature Range	T_{STG}	-40~150	$^\circ\text{C}$

Electrical Characteristics

($V_I=10\text{V}$, $I_O=40\text{mA}$, $0 < T_J < 125^\circ\text{C}$, $C_1=0.33\mu\text{F}$, $C_0=0.1\mu\text{F}$, unless otherwise specified)

Parameter	Symbol	Test Conditions	Min.	Typ.	Max.	Unit
Output Voltage	V_O	$T_J=25^\circ\text{C}$	4.8	5.0	5.2	V
		$I_O=1\text{mA}$ to 40mA, $V_I=7\text{V}$ to 20V	4.75	---	5.25	V
		$I_O=1\text{mA}$ to 70mA	4.75	---	5.25	V
Line Regulation	ΔV_O	$V_I=7\text{V}$ to 20V, $T_J=25^\circ\text{C}$	---	10	150	mV
		$V_I=8\text{V}$ to 20V, $T_J=25^\circ\text{C}$	---	5	100	mV
Load Regulation	ΔV_O	$I_O=1\text{mA}$ to 100mA, $T_J=25^\circ\text{C}$	---	15	60	mV
		$I_O=1\text{mA}$ to 40mA, $T_J=25^\circ\text{C}$	---	10	30	mV
Ripple Rejection	RR	$V_I=8\text{V}$ to 18V, $f=120\text{Hz}$, $T_J=25^\circ\text{C}$	40	49	---	dB
Quiescent Current	I_Q	$T_J=25^\circ\text{C}$	---	2.0	5.5	mA
Quiescent Current Change	ΔI_Q	$V_I=8\text{V}$ to 20V	---	---	1.5	mA
		$I_O=1\text{mA}$ to 40mA	---	---	0.1	mA
Output Noise Voltage	V_N	$10\text{Hz} \leq f \leq 100\text{KHz}$, $T_J=25^\circ\text{C}$	---	40	---	μV
Temperature coefficient of V_O	$\Delta V_O / \Delta T$	$I_O=5\text{mA}$		0.65		$\text{mV}/^\circ\text{C}$
Dropout Voltage	V_d			1.7		V

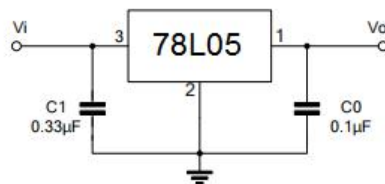

Typical Application

AT78L05TI

3-Terminal Voltage Regulator

Typical Characteristic Curves

Fig.1 78L05 Output Voltage vs Junction Temperature

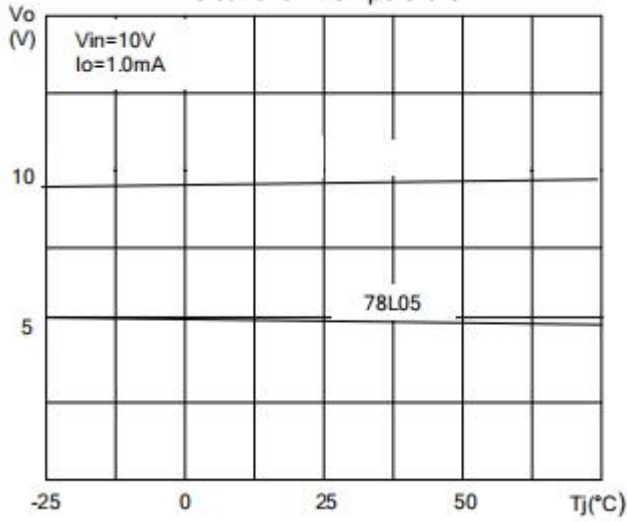

Fig.2 78L05 Quiescent Current vs Output Current

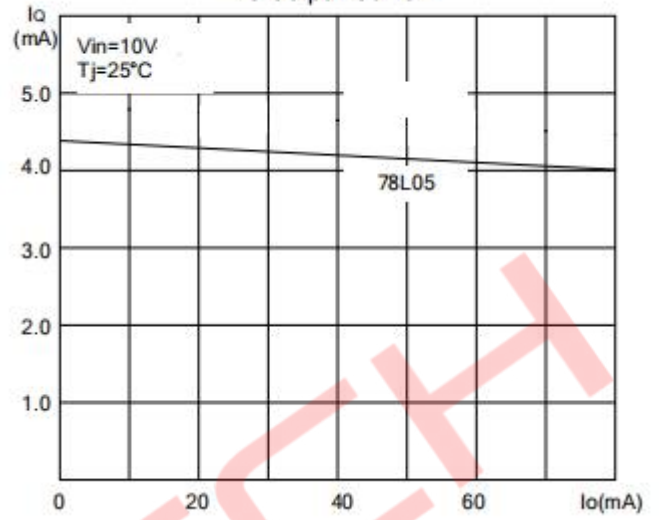

Fig.3 78L05 Quiescent Current vs Input

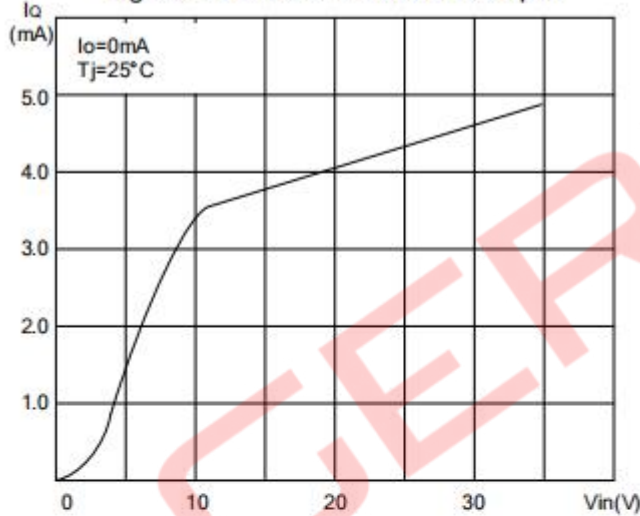

Fig.4 78L05 Thermal Shutdown

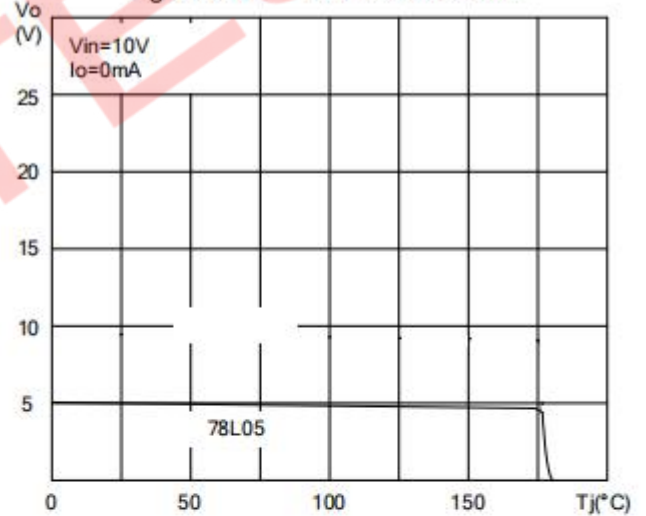

Fig.5 78L05 Output Characteristics

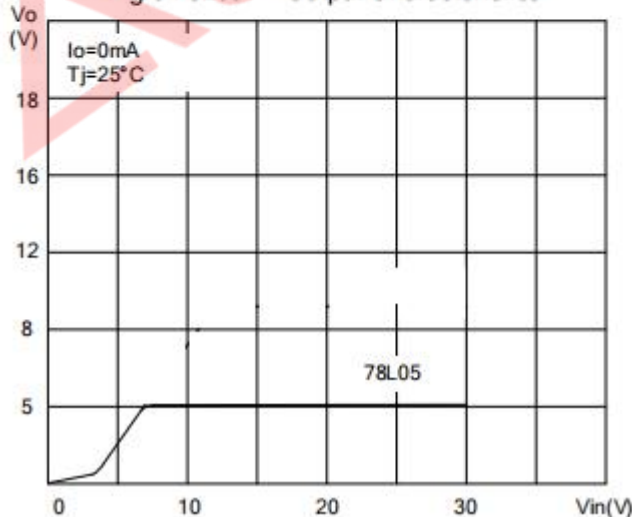
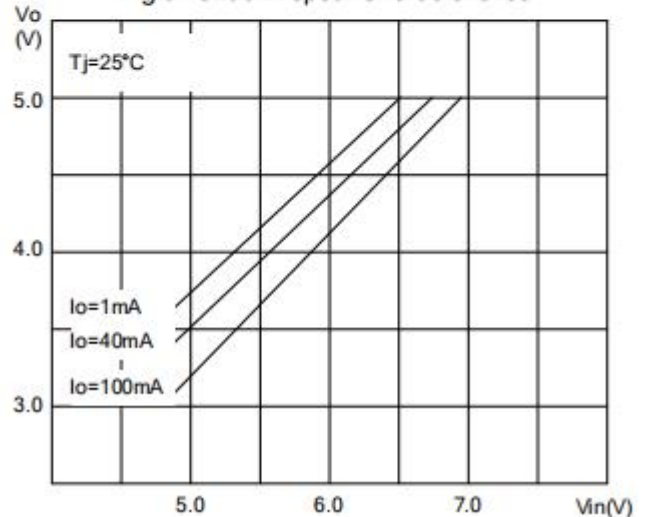

Fig.6 78L05 Dropout Characteristics



AT78L05TI

3-Terminal Voltage Regulator

Package Outline

TO-92

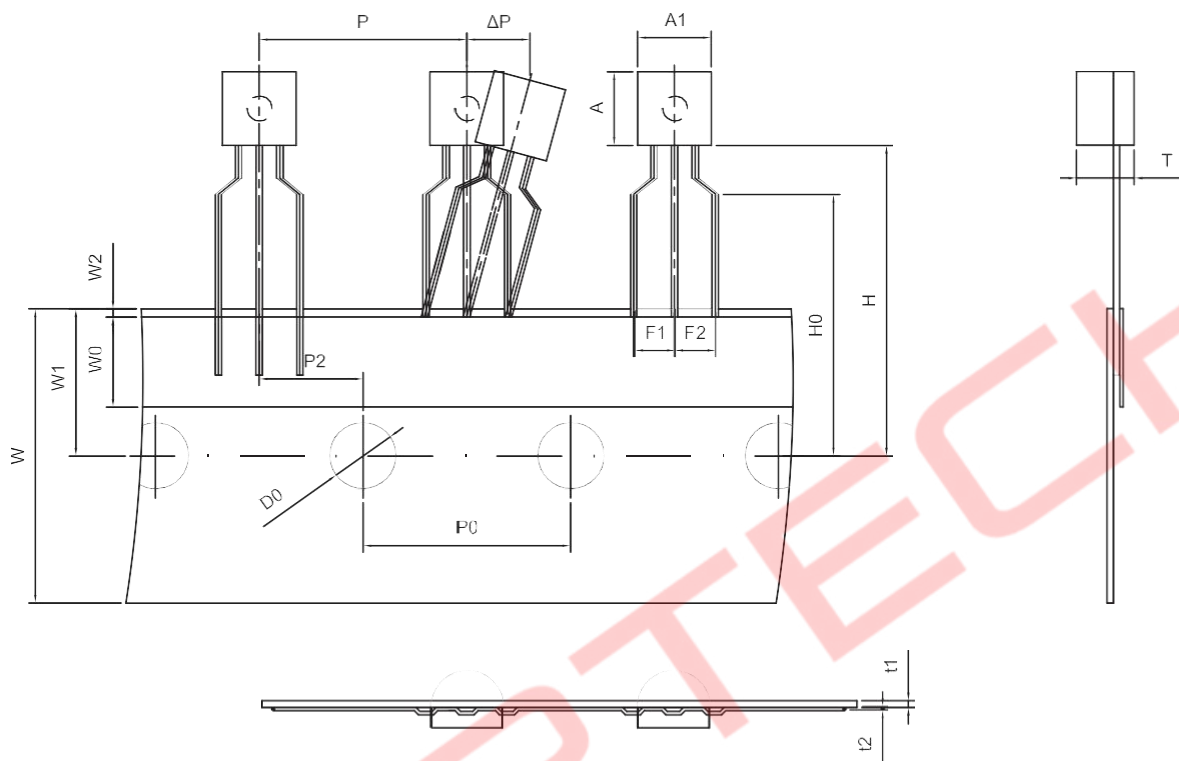

Dimensions are in millimeter

A1	A	T	P	P0	P2	F1	F2	W
4.5	4.5	3.5	12.7	12.7	6.35	2.5	2.5	18.0
W0	W1	W2	H	H0	D0	t1	t2	ΔP
6.0	9.0	1.0 MAX.	19.0	16.0	4.0	0.4	0.2	0