

National Semiconductor is now part of
Texas Instruments.

Search <http://www.ti.com/> for the latest technical
information and details on our current products and services.

DS2003/DS9667/DS2004 High Current/Voltage Darlington Drivers

General Description

The DS2003/DS9667/DS2004 are comprised of seven high voltage, high current NPN Darlington transistor pairs. All units feature common emitter, open collector outputs. To maximize their effectiveness, these units contain suppression diodes for inductive loads and appropriate emitter base resistors for leakage.

The DS2003/DS9667 has a series base resistor to each Darlington pair, thus allowing operation directly with TTL or CMOS operating at supply voltages of 5.0V.

The DS2004 has an appropriate input resistor to allow direct operation from CMOS or PMOS outputs operating from supply voltages of 6.0V to 15V.

The DS2003/DS9667/DS2004 offer solutions to a great many interface needs, including solenoids, relays, lamps, small motors, and LEDs. Applications requiring sink currents beyond the capability of a single output may be accommodated by paralleling the outputs.

Features

- Seven high gain Darlington pairs
- High output voltage ($V_{CE} = 50V$)
- High output current ($I_C = 350\text{ mA}$)
- TTL, PMOS, CMOS compatible
- Suppression diodes for inductive loads
- Extended temperature range

Connection Diagram

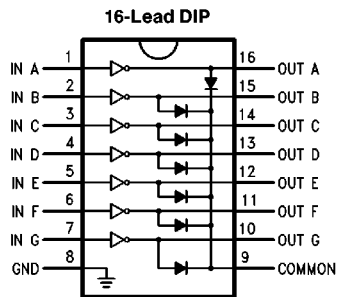

Top View

TL/F/9647-1

Order Numbers

	J Package Number J16A	N Package Number N16E	M Package Number M16A
DS2003 DS9667	DS2003MJ DS2003TJ DS2003CJ DS9667MJ DS9667TJ DS9667CJ	DS2003TN DS2003CN DS9667TN DS9667CN	DS2003TM DS2003CM
DS2004	DS2004MJ DS2004TJ DS2004CJ	DS2004TN DS2004CN	DS2004TM DS2004CM

Absolute Maximum Ratings (Note 1)

If Military/Aerospace specified devices are required, please contact the National Semiconductor Sales Office/Distributors for availability and specifications.

Storage Temperature Range	
Ceramic DIP	-65°C to +175°C
Molded DIP	-65°C to +150°C
Operating Temperature Range	
DS2003M/DS9667M	-55°C to +125°C
DS2004M	-55°C to +125°C
DS2003T/DS9667T	-40°C to +105°C
DS2004T	-40°C to +105°C
DS2003C/DS9667C	0°C to +85°C
DS2004C	0°C to +85°C

Lead Temperature	
Ceramic DIP (Soldering, 60 seconds)	300°C
Molded DIP (Soldering, 10 seconds)	265°C
Maximum Power Dissipation* at 25°C	
Cavity Package	2016 mW
Molded Package	1838 mW
S.O. Package	926 mW
*Derate cavity package 16.13 mW/°C above 25°C; derate molded DIP package 14.7 mW/°C above 25°C. Derate S.O. package 7.4 mW/°C.	
Input Voltage	30V
Output Voltage	55V
Emitter-Base Voltage	6.0V
Continuous Collector Current	500 mA
Continuous Base Current	25 mA

Electrical Characteristics $T_A = 25^\circ\text{C}$, unless otherwise specified (Note 2)

Symbol	Parameter	Conditions	Min	Typ	Max	Units
I_{CEX}	Output Leakage Current	$T_A = 25^\circ\text{C}, V_{CE} = 50\text{V}$ (Figure 1a)			20	μA
		$T_A = 85^\circ\text{C}, V_{CE} = 50\text{V}$ (Figure 1a) for Commercial Grade			100	
		$T_A = 25^\circ\text{C}, V_{CE} = 50\text{V}, V_I = 1.0\text{V}$ (Figure 1b) DS2004			500	
$V_{CE(Sat)}$	Collector-Emitter Saturation Voltage	$I_C = 350\text{ mA}, I_B = 500\ \mu\text{A}$ (Figure 2) (Note 3)		1.25	1.6	V
		$I_C = 200\text{ mA}, I_B = 350\ \mu\text{A}$ (Figure 2)		1.1	1.3	
		$I_C = 100\text{ mA}, I_B = 250\ \mu\text{A}$ (Figure 2)		0.9	1.1	
$I_{I(ON)}$	Input Current	$V_I = 3.85\text{V}$ (Figure 3) DS2003/DS9667		0.93	1.35	mA
		$V_I = 5.0\text{V}$ (Figure 3) DS2004		0.35	0.5	
		$V_I = 12\text{V}$ (Figure 3)		1.0	1.45	
$I_{I(OFF)}$	Input Current (Note 4)	$T_A = 85^\circ\text{C}$ for Commercial $I_C = 500\ \mu\text{A}$ (Figure 4)	50	100		μA
$V_{I(ON)}$	Input Voltage (Note 5)	$V_{CE} = 2.0\text{V}, I_C = 200\text{ mA}$ (Figure 5) DS2003/DS9667			2.4	V
		$V_{CE} = 2.0\text{V}, I_C = 250\text{ mA}$ (Figure 5)			2.7	
		$V_{CE} = 2.0\text{V}, I_C = 300\text{ mA}$ (Figure 5)			3.0	
		$V_{CE} = 2.0\text{V}, I_C = 125\text{ mA}$ (Figure 5) DS2004			5.0	
		$V_{CE} = 2.0\text{V}, I_C = 200\text{ mA}$ (Figure 5)			6.0	
		$V_{CE} = 2.0\text{V}, I_C = 275\text{ mA}$ (Figure 5)			7.0	
		$V_{CE} = 2.0\text{V}, I_C = 350\text{ mA}$ (Figure 5)			8.0	
C_I	Input Capacitance			15	30	pF
t_{PLH}	Turn-On Delay	$0.5 V_I$ to $0.5 V_O$			1.0	μs
t_{PHL}	Turn-Off Delay	$0.5 V_I$ to $0.5 V_O$			1.0	μs
I_R	Clamp Diode Leakage Current	$V_R = 50\text{V}$ (Figure 6)	$T_A = 25^\circ\text{C}$		50	μA
			$T_A = 85^\circ\text{C}$		100	μA
V_F	Clamp Diode Forward Voltage	$I_F = 350\text{ mA}$ (Figure 7)		1.7	2.0	V

Note 1: "Absolute Maximum Ratings" are those values beyond which the safety of the device cannot be guaranteed. They are not meant to imply that the devices should be operated at these limits. The tables of "Electrical Characteristics" provide conditions for actual device operation.

Note 2: All limits apply to the complete Darlington series except as specified for a single device type.

Note 3: Under normal operating conditions these units will sustain 350 mA per output with $V_{CE(Sat)} = 1.6\text{V}$ at 70°C with a pulse width of 20 ms and a duty cycle of 30%.

Note 4: The $I_{I(OFF)}$ current limit guaranteed against partial turn-on of the output.

Note 5: The $V_{I(ON)}$ voltage limit guarantees a minimum output sink current per the specified test conditions.

Typical Performance Characteristics

Collector Current vs Saturation Voltage

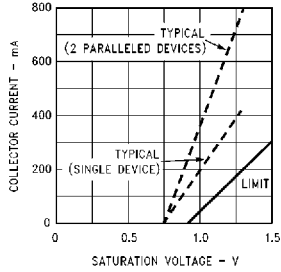

Collector Current vs Input Current

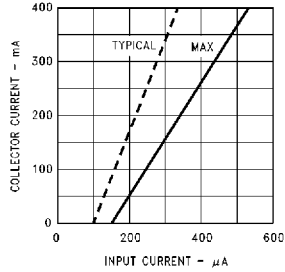

**DS2003/DS9667
Input Current vs Input Voltage**

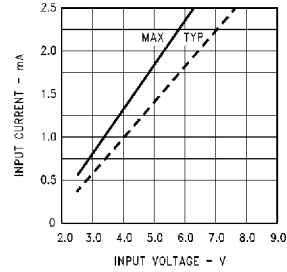

**DS2004
Input Current vs Input Voltage**

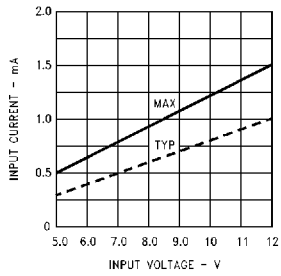

Peak Collector Current vs Duty Cycle and Number of Outputs (Molded Package)

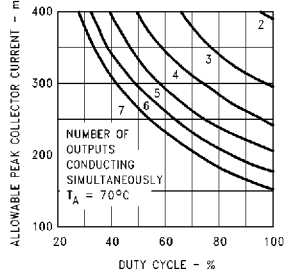

Peak Collector Current vs Duty Cycle and Number of Outputs (Ceramic Package)

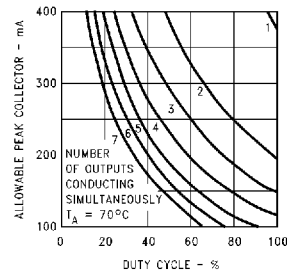

TL/F/9647-6

Equivalent Circuits

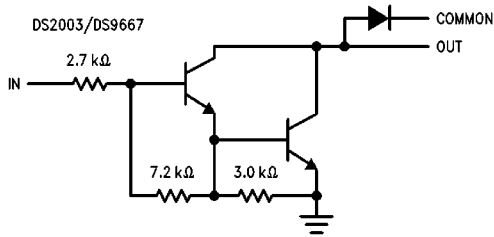

TL/F/9647-3

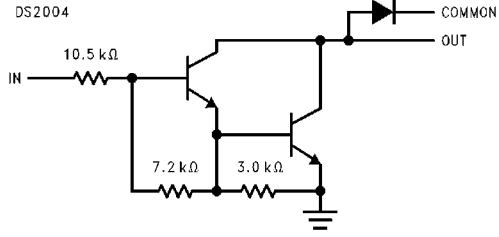

TL/F/9647-5

Test Circuits

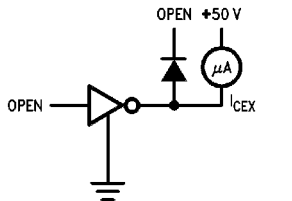

TL/F/9647-7

FIGURE 1a

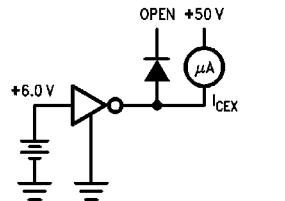

TL/F/9647-8

FIGURE 1b

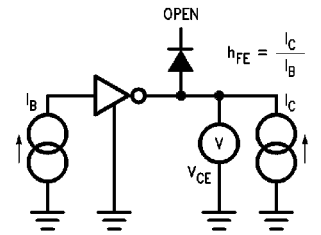

TL/F/9647-9

FIGURE 2

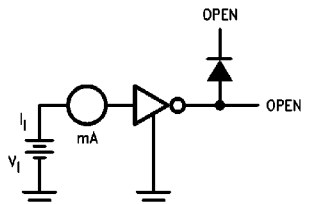

TL/F/9647-10

FIGURE 3

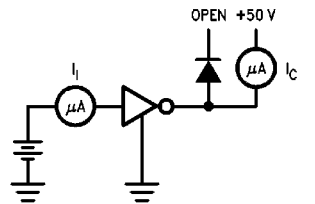

TL/F/9647-11

FIGURE 4

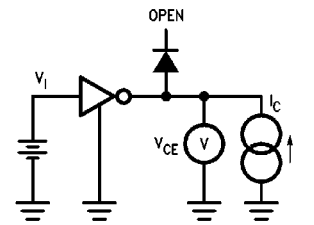

TL/F/9647-12

FIGURE 5

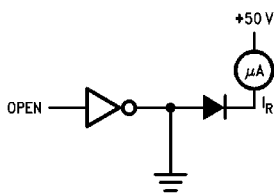

TL/F/9647-13

FIGURE 6

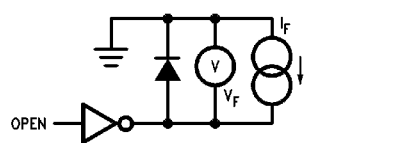

TL/F/9647-14

FIGURE 7

Typical Applications

Buffer for Higher Current Loads

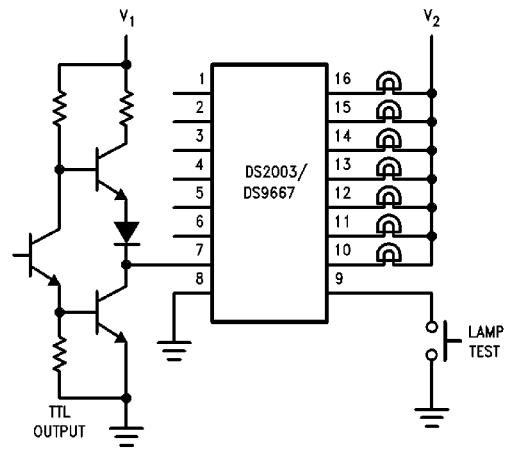

TL/F/9647-16

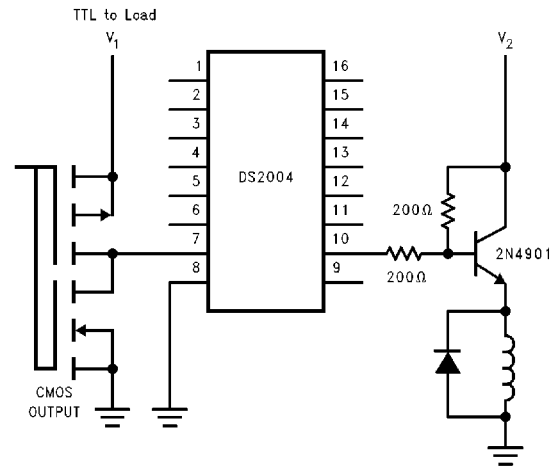

TL/F/9647-17

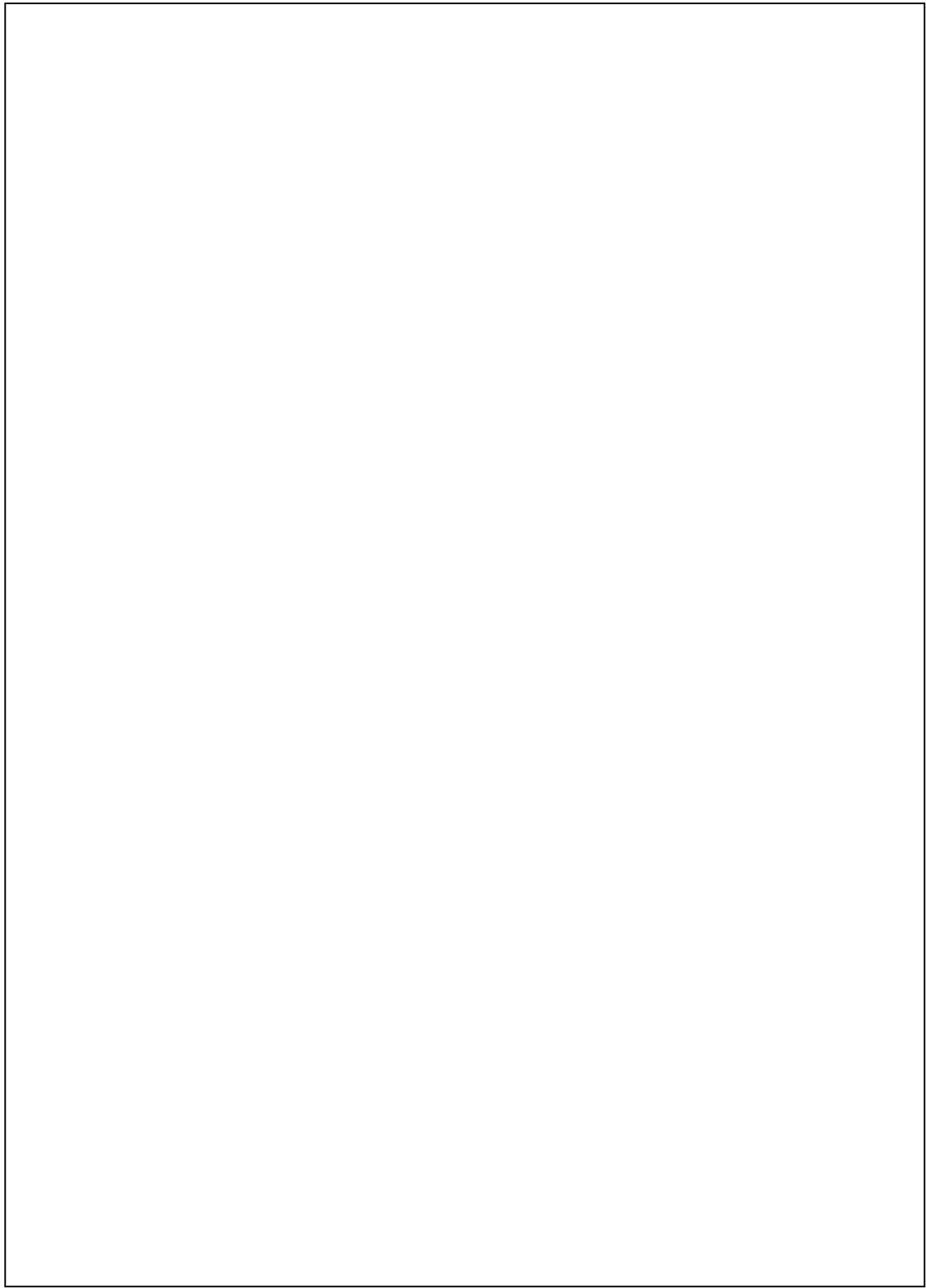

Physical Dimensions inches (millimeters) unless otherwise noted

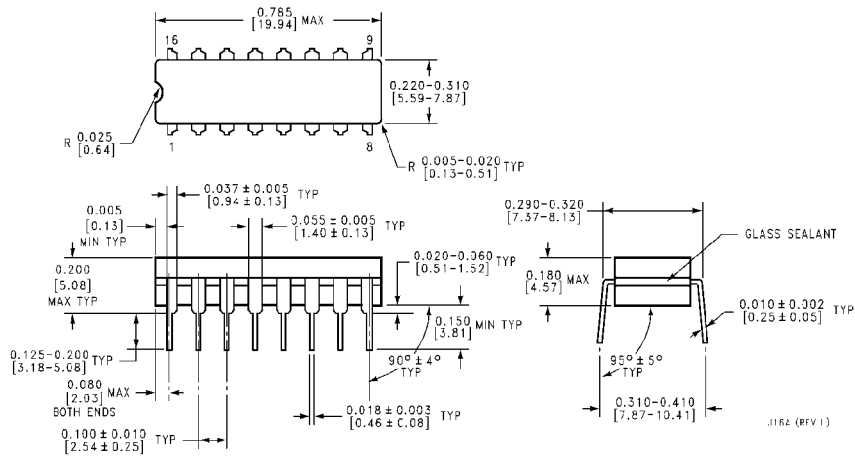

Ceramic Dual-In-Line Package (J)
Order Number DS2003CJ, DS9667CJ, DS2003MJ, D9667MJ,
DS2003TJ, DS9667TJ, DS2004CJ, DS2004MJ or DS2004TJ
NS Package Number J16A

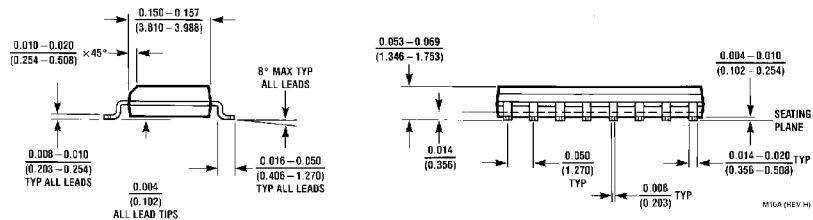
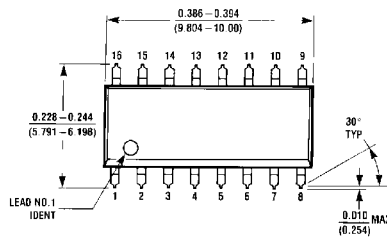

Surface Mount Package (M)
Order Number DS2003CM, DS9667CM, DS2003TM, DS9667TM, DS2004CM or DS2004TM
NS Package Number M16A

Physical Dimensions inches (millimeters) unless otherwise noted (Continued)

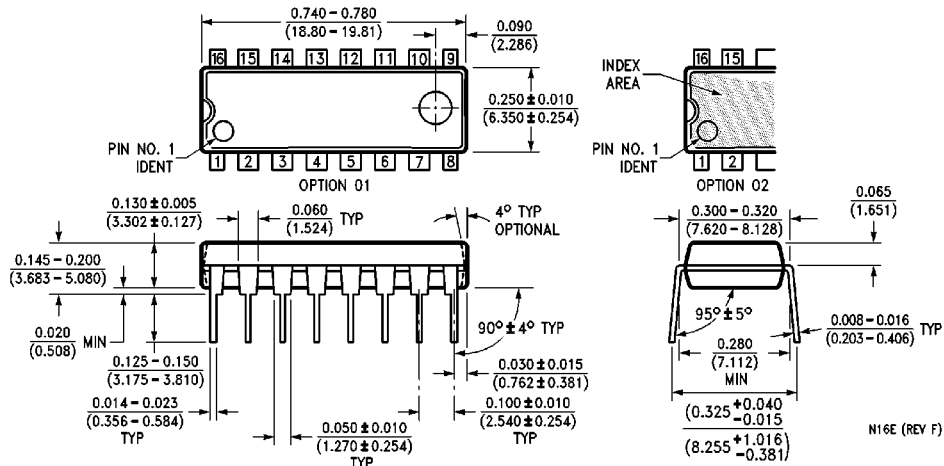

Molded Dual-In-Line Package (N)

Order Number DS2003CN, DS9667CN, DS2003TN, DS9667TN, DS2004CN or DS2004TN
NS Package Number N16E

LIFE SUPPORT POLICY

NATIONAL'S PRODUCTS ARE NOT AUTHORIZED FOR USE AS CRITICAL COMPONENTS IN LIFE SUPPORT DEVICES OR SYSTEMS WITHOUT THE EXPRESS WRITTEN APPROVAL OF THE PRESIDENT OF NATIONAL SEMICONDUCTOR CORPORATION. As used herein:

1. Life support devices or systems are devices or systems which, (a) are intended for surgical implant into the body, or (b) support or sustain life, and whose failure to perform, when properly used in accordance with instructions for use provided in the labeling, can be reasonably expected to result in a significant injury to the user.
2. A critical component is any component of a life support device or system whose failure to perform can be reasonably expected to cause the failure of the life support device or system, or to affect its safety or effectiveness.



National Semiconductor Corporation
1111 West Bardin Road
Arlington, TX 76017
Tel: 1(800) 272-9959
Fax: 1(800) 737-7018

<http://www.national.com>

National Semiconductor Europe
Fax: +49 (0) 180-530 85 86
Email: europe.support@nsc.com
Deutsch Tel: +49 (0) 180-530 85 85
English Tel: +49 (0) 180-532 78 32
Français Tel: +49 (0) 180-532 93 58
Italiano Tel: +49 (0) 180-534 16 80

National Semiconductor Hong Kong Ltd.
13th Floor, Straight Block,
Ocean Centre, 5 Canton Rd.
Tsimshatsui, Kowloon
Hong Kong
Tel: (852) 2737-1600
Fax: (852) 2736-9960

National Semiconductor Japan Ltd.
Tel: 81-043-299-2308
Fax: 81-043-299-2408

National does not assume any responsibility for use of any circuitry described, no circuit patent licenses are implied and National reserves the right at any time without notice to change said circuitry and specifications.