

# LM3311 Step-Up PWM DC/DC Converter with Integrated LDO, Op-Amp, and Gate Pulse Modulation Switch

Check for Samples: [LM3311](#)

## FEATURES

- **Boost Converter with a 2A, 0.18Ω Switch**
- **Boost Output Voltage Adjustable up to 20V**
- **Operating Voltage Range of 2.5V to 7V**
- **660kHz/1.28MHz Pin Selectable Switching Frequency**
- **Adjustable Soft-Start Function**
- **Input Undervoltage Protection**
- **Over Temperature Protection**
- **Adjustable Low Dropout Linear Regulator (LDO)**
- **Integrated Op-Amp**
- **Integrated Gate Pulse Modulation (GPM) Switch**
- **24-Lead WQFN Package**

## APPLICATIONS

- **TFT Bias Supplies**
- **Portable Applications**

## DESCRIPTION

The LM3311 is a step-up DC/DC converter integrated with an LDO, an Operational Amplifier, and a gate pulse modulation switch. The boost (step-up) converter is used to generate an adjustable output voltage and features a low  $R_{\text{DS(on)}}$  internal switch for maximum efficiency. The operating frequency is selectable between 660kHz and 1.28MHz allowing for the use of small external components. An external soft-start pin enables the user to tailor the soft-start time to a specific application and limit the inrush current. The LDO also has an adjustable output voltage and is stable using ceramic output capacitors. The Op-Amp is capable of sourcing/sinking 135mA of current (typical) for the standard version and 200mA (typical) for the HIOP version. The gate pulse modulation switch can operate with a VGH voltage of 5V to 30V. The LM3311 is available in a low profile 24-lead WQFN package.



Please be aware that an important notice concerning availability, standard warranty, and use in critical applications of Texas Instruments semiconductor products and disclaimers thereto appears at the end of this data sheet.

All trademarks are the property of their respective owners.

Typical Application Circuit

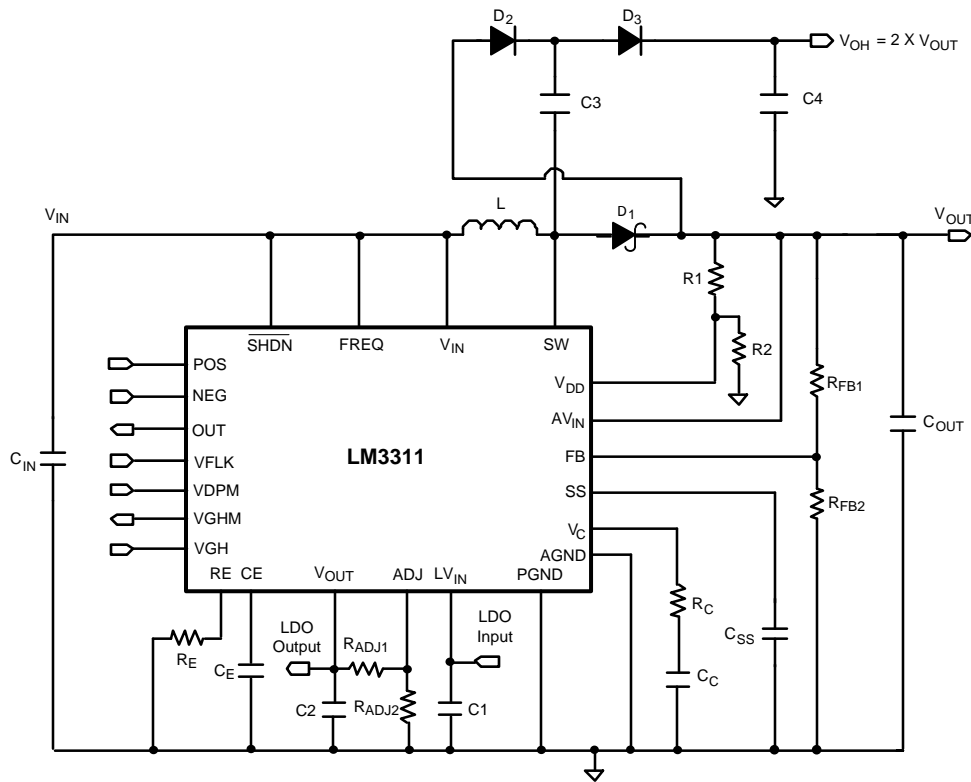

Connection Diagram

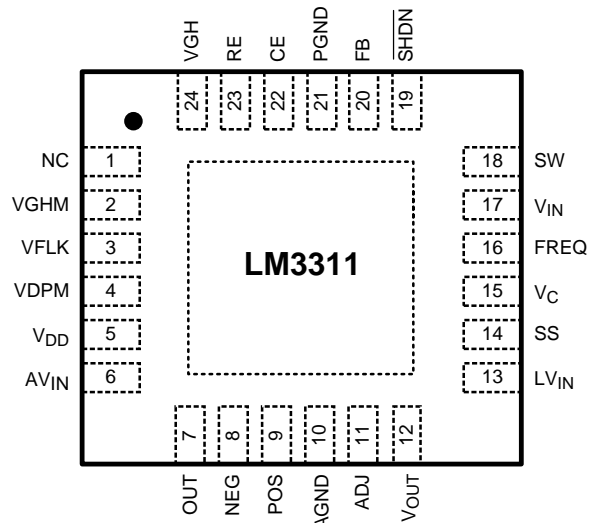

Figure 1. 24-Lead WQFN (Top View)  
See RTW0024A Package  
 $\theta_{JA}=37^{\circ}\text{C/W}$

Pin Descriptions

Pin	Name	Function
1	NC	Not internally connected.

**Pin Descriptions (continued)**

Pin	Name	Function
2	VGHM	Output of GPM circuit. This output directly drives the supply for the gate driver circuits.
3	VFLK	Determines when the TFT LCD is on or off. This is controlled by the timing controller in the LCD module.
4	VDPM	VDPM pin is the enable signal for the GPM block. Pulling this pin high enables the GPM while pulling this pin low disables it. VDPM is used for timing sequence control.
5	V <sub>DD</sub>	Reference input for gate pulse modulation (GPM) circuit. The voltage at V <sub>DD</sub> is used to set the lower VGHM voltage. If the GPM function is not used connect V <sub>DD</sub> to V <sub>IN</sub> .
6	AV <sub>IN</sub>	Op-Amp analog power input.
7	OUT	Output of the Op-Amp.
8	NEG	Negative input terminal of the Op-Amp.
9	POS	Positive input terminal of the Op-Amp.
10	AGND	Analog ground for the step-up regulator, LDO, and Op-Amp. Connect directly to DAP and PGND beneath the device.
11	ADJ	LDO output voltage feedback input.
12	V <sub>OUT</sub>	LDO regulator output.
13	LV <sub>IN</sub>	LDO power input.
14	SS	Boost converter soft start pin.
15	V <sub>C</sub>	Boost compensation network connection. Connected to the output of the voltage error amplifier.
16	FREQ	Switching frequency select input. Connect this pin to V <sub>IN</sub> for 1.28MHz operation and AGND for 660kHz operation.
17	V <sub>IN</sub>	Boost converter and GPM power input.
18	SW	Boost power switch input. Switch connected between SW pin and PGND pin.
19	$\overline{\text{SHDN}}$	Shutdown pin. Active low, pulling this pin low will disable the LM3311.
20	FB	Boost output voltage feedback input.
21	PGND	Power Ground. Source connection of the step-up regulator NMOS switch and ground for the GPM circuit. Connect AGND and PGND directly to the DAP beneath the device.
22	CE	Connect capacitor from this pin to AGND.
23	RE	Connect a resistor between RE and PGND.
24	VGH	GPM power supply input. VGH range is 5V to 30V.
DAP		Die Attach Pad. Internally connected to GND. Connect AGND and PGND pins directly to this pad beneath the device.

Block Diagrams

Boost Converter

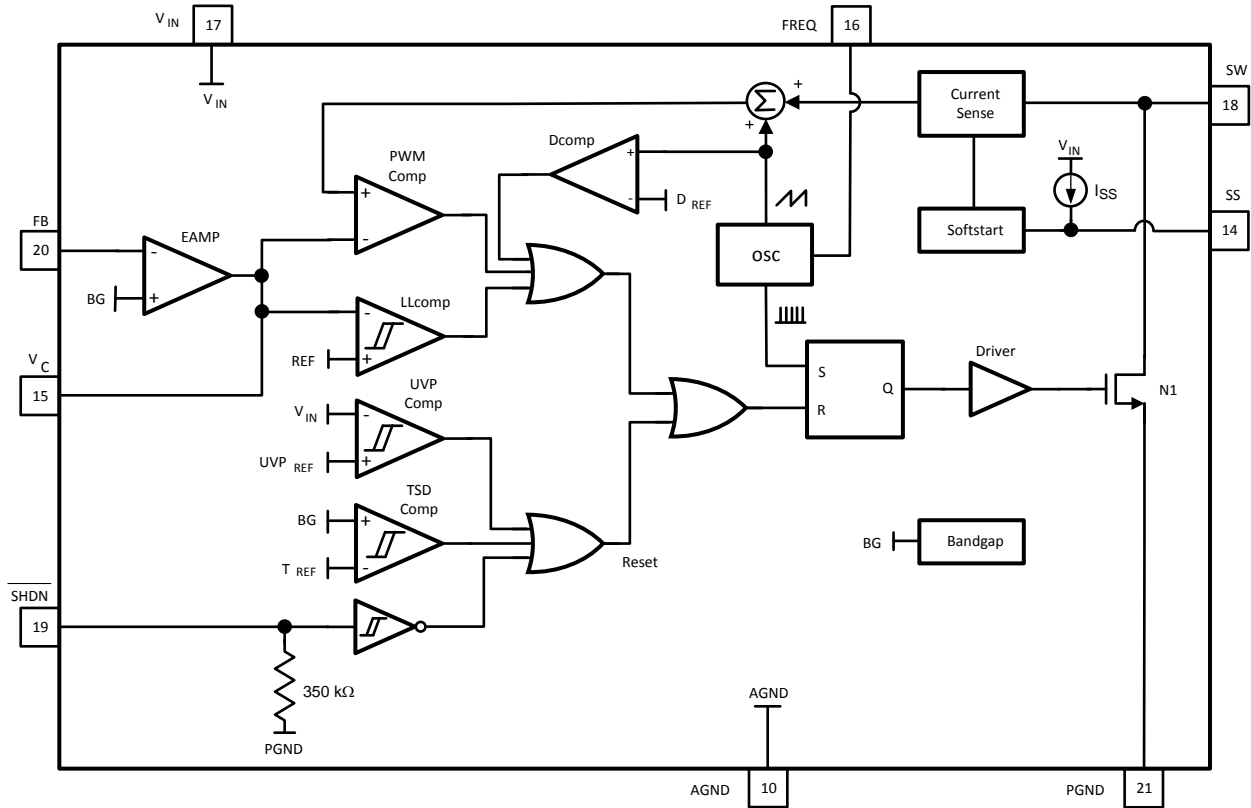

Figure 2.

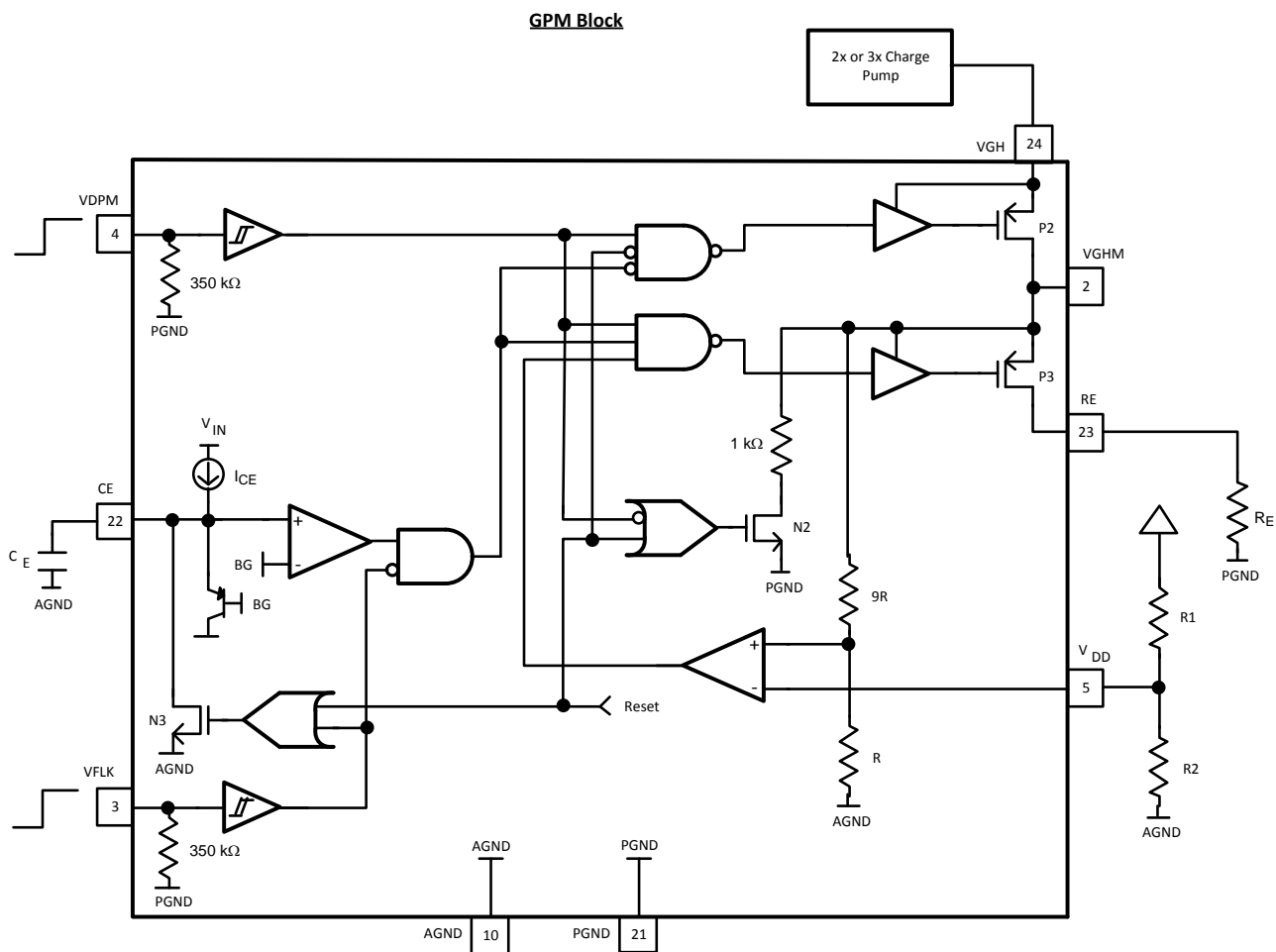

Figure 3.

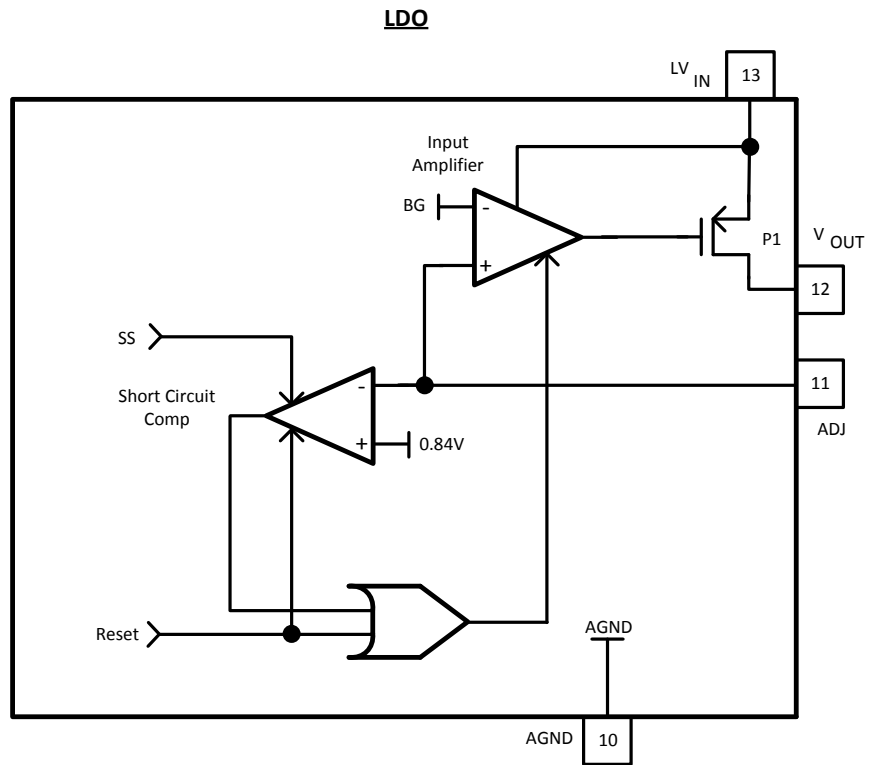

Figure 4.

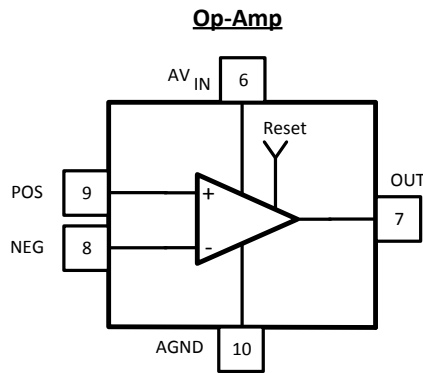

Figure 5.



These devices have limited built-in ESD protection. The leads should be shorted together or the device placed in conductive foam during storage or handling to prevent electrostatic damage to the MOS gates.

**Absolute Maximum Ratings** <sup>(1)(2)</sup>

V <sub>IN</sub>	7.5V
SW Voltage	21V
FB Voltage	V <sub>IN</sub>
V <sub>C</sub> Voltage <sup>(3)</sup>	1.265V ± 0.3V
$\overline{\text{SHDN}}$ Voltage	7.5V
FREQ	V <sub>IN</sub>
AV <sub>IN</sub>	14.5V
Amplifier Inputs/Output	Rail-to-Rail
LV <sub>IN</sub>	7.5V
ADJ Voltage	LV <sub>IN</sub>
V <sub>OUT</sub>	LV <sub>IN</sub>
VGH Voltage	31V
VGHM Voltage	VGH
VFLK, VDPM, V <sub>DD</sub> Voltage	7.5V
CE Voltage <sup>(3)</sup>	1.265 + 0.3V
RE Voltage	VGH
Maximum Junction Temperature	150°C
Power Dissipation <sup>(4)</sup>	Internally Limited
Lead Temperature	300°C
Vapor Phase (60 sec.)	215°C
Infrared (15 sec.)	220°C
ESD Susceptibility <sup>(5)</sup>	
Human Body Model	2kV

- (1) Absolute maximum ratings are limits beyond which damage to the device may occur. Operating Ratings are conditions for which the device is intended to be functional, but device parameter specifications may not be ensured. For ensured specifications and test conditions, see the Electrical Characteristics.
- (2) If Military/Aerospace specified devices are required, please contact the Texas Instruments Sales Office/ Distributors for availability and specifications.
- (3) Under normal operation the V<sub>C</sub> and CE pins may go to voltages above this value. The maximum rating is for the possibility of a voltage being applied to the pin, however the V<sub>C</sub> and CE pins should never have a voltage directly applied to them.
- (4) The maximum allowable power dissipation is a function of the maximum junction temperature, T<sub>J</sub>(MAX), the junction-to-ambient thermal resistance,  $\theta_{JA}$ , and the ambient temperature, T<sub>A</sub>. See the Electrical Characteristics table for the thermal resistance of various layouts. The maximum allowable power dissipation at any ambient temperature is calculated using: P<sub>D</sub> (MAX) = (T<sub>J</sub>(MAX) – T<sub>A</sub>)/ $\theta_{JA}$ . Exceeding the maximum allowable power dissipation will cause excessive die temperature, and the regulator will go into thermal shutdown.
- (5) The human body model is a 100pF capacitor discharged through a 1.5k $\Omega$  resistor into each pin per JEDEC standard JESD22-A114.

**Operating Conditions**

Operating Junction Temperature Range <sup>(1)</sup>	–40°C to +125°C
Storage Temperature	–65°C to +150°C
Supply Voltage	2.5V to 7V
Maximum SW Voltage	20V
VGH Voltage Range	5V to 30V
Op-Amp Supply, AV <sub>IN</sub>	4V to 14V
LDO Supply, LV <sub>IN</sub>	2.5V to 7V

- (1) All limits specified at room temperature (standard typeface) and at temperature extremes (bold typeface). All room temperature limits are 100% production tested. All limits at temperature extremes are specified via correlation using standard Statistical Quality Control (SQC) methods. All limits are used to calculate Average Outgoing Quality Level (AOQL).

## Electrical Characteristics

Specifications in standard type face are for  $T_J = 25^\circ\text{C}$  and those with **boldface type** apply over the full **Operating Temperature Range** ( $T_J = -40^\circ\text{C}$  to  $+125^\circ\text{C}$ ). Unless otherwise specified,  $V_{IN} = LV_{IN} = 2.5\text{V}$  and  $I_L = 0\text{A}$ .

Symbol	Parameter	Conditions	Min (1)	Typ (2)	Max (1)	Units	
$I_Q$	Quiescent Current	FB = 2V (Not Switching)		690	<b>1100</b>	$\mu\text{A}$	
		$V_{\overline{\text{SHDN}}} = 0\text{V}$		0.04	0.5 <b>8.5</b>		
		660kHz Switching			2.1	<b>2.8</b>	mA
		1.28MHz Switching			3.1	<b>4.0</b>	
$V_{\text{FB}}$	Feedback Voltage		<b>1.231</b>	1.263	<b>1.287</b>	V	
$\%V_{\text{FB}}/\Delta V_{\text{IN}}$	Feedback Voltage Line Regulation	$2.5\text{V} \leq V_{\text{IN}} \leq 7\text{V}$	<b>-0.26</b>	0.089	<b>0.42</b>	%/V	
$I_{\text{CL}}$	Switch Current Limit (3)	(4)	<b>2.0</b>	2.6		A	
$I_{\text{B}}$	FB Pin Bias Current (5)			27	<b>160</b>	nA	
$I_{\text{SS}}$	SS Pin Current		<b>8.5</b>	11	<b>13.5</b>	$\mu\text{A}$	
$V_{\text{SS}}$	SS Pin Voltage		<b>1.20</b>	1.24	<b>1.28</b>	V	
$V_{\text{IN}}$	Input Voltage Range		<b>2.5</b>		<b>7</b>	V	
$g_m$	Error Amp Transconductance	$\Delta I = 5\mu\text{A}$	<b>26</b>	74	<b>133</b>	$\mu\text{mho}$	
$A_V$	Error Amp Voltage Gain			69		V/V	
$D_{\text{MAX}}$	Maximum Duty Cycle	$f_S = 660\text{kHz}$	<b>80</b>	91		%	
		$f_S = 1.28\text{MHz}$	<b>80</b>	89			
$f_S$	Switching Frequency	FREQ = Ground	<b>440</b>	660	<b>760</b>	kHz	
		FREQ = $V_{\text{IN}}$	<b>1.0</b>	1.28	<b>1.5</b>	MHz	
$I_{\overline{\text{SHDN}}}$	Shutdown Pin Current	$V_{\overline{\text{SHDN}}} = 2.5\text{V}$		8	<b>13.5</b>	$\mu\text{A}$	
		$V_{\overline{\text{SHDN}}} = 0.3\text{V}$		1	<b>2</b>		
$I_L$	Switch Leakage Current	$V_{\text{SW}} = 20\text{V}$		0.03	<b>5</b>	$\mu\text{A}$	
$R_{\text{DS(on)}}$	Switch $R_{\text{DS(on)}}$	$I_{\text{SW}} = 500\text{mA}$		0.18	<b>0.35</b>	$\Omega$	
$T_{\text{HSHDN}}$	$\overline{\text{SHDN}}$ Threshold	Output High, $V_{\text{IN}} = 2.5\text{V}$ to $7\text{V}$	<b>1.4</b>			V	
		Output Low, $V_{\text{IN}} = 2.5\text{V}$ to $7\text{V}$			<b>0.4</b>		
UVP	Undervoltage Protection Threshold	On Threshold (Switch On)	<b>2.5</b>	2.4		V	
		Off Threshold (Switch Off)		2.3	<b>2.1</b>		
$I_{\text{FREQ}}$	FREQ Pin Current	FREQ = $V_{\text{IN}} = 2.5\text{V}$		2.7	<b>13.5</b>	$\mu\text{A}$	
<b>Operational Amplifier</b>							
$V_{\text{OS}}$	Input Offset Voltage	Buffer configuration, $V_{\text{O}} = AV_{\text{IN}}/2$ , no load		5.7	<b>15</b>	mV	
		Buffer configuration, $V_{\text{O}} = AV_{\text{IN}}/2$ , no load (HIOP version)		5.7	<b>16</b>		
$I_{\text{B}}$	Input Bias Current (POS Pin)	Buffer configuration, $V_{\text{O}} = AV_{\text{IN}}/2$ , no load (5)		200	<b>550</b>	nA	
$V_{\text{OUT}}$ Swing		Buffer, $R_L = 2\text{k}\Omega$ , $V_{\text{O}}$ min.		0.001	<b>0.03</b>	V	
		Buffer, $R_L = 2\text{k}\Omega$ , $V_{\text{O}}$ max.	<b>7.9</b>	7.97			
$AV_{\text{IN}}$	Supply Voltage		<b>4</b>		<b>14</b>	V	
$I_{\text{S+}}$	Supply Current	Buffer, $V_{\text{O}} = AV_{\text{IN}}/2$ , No Load		1.5	<b>7.8</b>	mA	
		Buffer, $V_{\text{O}} = AV_{\text{IN}}/2$ , No Load (HIOP version)		2.5	<b>9</b>		

(1) All limits specified at room temperature (standard typeface) and at temperature extremes (bold typeface). All room temperature limits are 100% production tested. All limits at temperature extremes are specified via correlation using standard Statistical Quality Control (SQC) methods. All limits are used to calculate Average Outgoing Quality Level (AOQL).

(2) Typical numbers are at  $25^\circ\text{C}$  and represent the most likely norm.

(3) Duty cycle affects current limit due to ramp generator.

(4) Current limit at 0% duty cycle. See [Typical Performance Characteristics](#) section for Switch Current Limit vs.  $V_{\text{IN}}$

(5) Bias current flows into pin.



## Electrical Characteristics (continued)

Specifications in standard type face are for  $T_J = 25^\circ\text{C}$  and those with **boldface type** apply over the full **Operating Temperature Range** ( $T_J = -40^\circ\text{C}$  to  $+125^\circ\text{C}$ ). Unless otherwise specified,  $V_{IN} = LV_{IN} = 2.5\text{V}$  and  $I_L = 0\text{A}$ .

Symbol	Parameter	Conditions	Min (1)	Typ (2)	Max (1)	Units
$I_{OUT}$	Output Current	Source	<b>90</b>	138	<b>195</b>	mA
		Sink	<b>105</b>	135	<b>175</b>	
		Source (HIOP version)	<b>140</b>	215	<b>270</b>	
		Sink (HIOP version)	<b>175</b>	205	<b>260</b>	
SR	Slew Rate	$C_L = 10\text{pF}$ (6)		50		V/ $\mu\text{s}$
GBW	Gain Bandwidth	-3dB, $C_L = 100\text{pF}$		3.3		MHz
<b>Gate Pulse Modulation</b>						
VFLK	VFLK Voltage Levels	Rising edge threshold			<b>1.4</b>	V
		Falling edge threshold	<b>0.4</b>			
VDPM	VDPM Voltage Levels	Rising edge threshold			<b>1.4</b>	V
		Falling edge threshold	<b>0.4</b>			
$V_{DD(TH)}$	$V_{DD}$ Threshold	VGHM = 30V	<b>2.8</b>	3	<b>3.3</b>	V
		VGHM = 5V	<b>0.4</b>	0.5	<b>0.7</b>	
$I_{VFLK}$	VFLK Current	VFLK = 1.5V		4.8	<b>11</b>	$\mu\text{A}$
		VFLK = 0.3V		1.1	<b>2.5</b>	
$I_{VDPM}$	VDPM Current	VDPM = 1.5V		4.8	<b>11</b>	$\mu\text{A}$
		VDPM = 0.3V		1.1	<b>2.5</b>	
$I_{VGH}$	VGH Bias Current	VGH = 30V, VFLK High		59	<b>300</b>	$\mu\text{A}$
		VGH = 30V, VFLK Low		11	<b>35.5</b>	
$R_{VGH-VGHM}$	VGH to VGHM Resistance	20mA Current, VGH = 30V		14	<b>28.5</b>	$\Omega$
$R_{VGHM-RE}$	VGHM to RE Resistance	20mA Current, VGH = VGHM = 30V		27	<b>55</b>	
$R_{VGHM(OFF)}$	VGH Resistance	VDPM is Low, VGHM = 2V		1.2	<b>1.7</b>	k $\Omega$
$I_{CE}$	CE Current	CE = 0V	<b>40</b>	57	<b>71</b>	$\mu\text{A}$
$V_{CE(TH)}$	CE Voltage Threshold		<b>1.16</b>	1.22	<b>1.30</b>	V
<b>Low Dropout Linear Regulator (LDO)</b>						
$LV_{IN}$	Input Voltage Range		<b>2.5</b>		<b>7</b>	V
$V_{ADJ}$	ADJ Pin Voltage	$LV_{IN} = 3\text{V}$ and $7\text{V}$	<b>1.197</b>	1.263	<b>1.289</b>	V
$I_{ADJ}$	ADJ Pin Current (7)			28	<b>380</b>	nA
$\%V_{ADJ}/\Delta V_{IN}$	ADJ Voltage Line Regulation	$LV_{IN} = 3\text{V}$ to $7\text{V}$ , $LDO_{OUT} = 2.8\text{V}$ , no load	<b>-2.6</b>	0.032	<b>1.4</b>	%
$\%V_{ADJ}/\Delta I_L$	$LDO_{OUT}$ Load Regulation	$I_{OUT} = 10\text{mA}$ to $300\text{mA}$ , $LV_{IN} = 3.3\text{V}$ , $LDO_{OUT} = 2.8\text{V}$	<b>-11.6</b>	2.931	<b>8</b>	%
$I_{QL}$	$LV_{IN}$ Quiescent Current	Device enabled		290	<b>425</b>	$\mu\text{A}$
		Device shut down			<b>10.5</b>	
$V_{DO}$	Dropout Voltage	350mA load, $LDO_{OUT} = 2.8\text{V}$	<b>218</b>	409	<b>674</b>	mV
$V_{ADJ(LOW)}$	$V_{ADJ}$ Short Circuit Disable Threshold	$LV_{IN} = 3.3\text{V}$		0.85	<b>0.9</b>	V

(6) Input signal is overdriven to force the output to swing rail to rail.

(7) Bias current flows into pin.

Typical Performance Characteristics

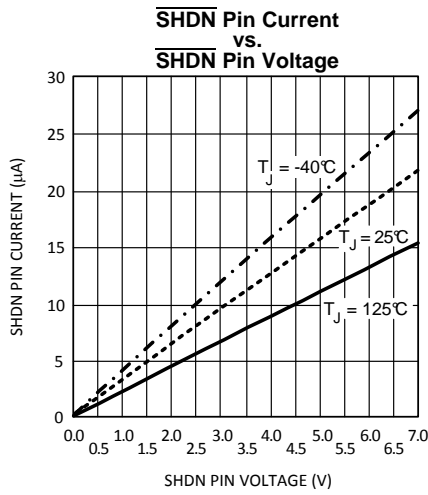

Figure 6.

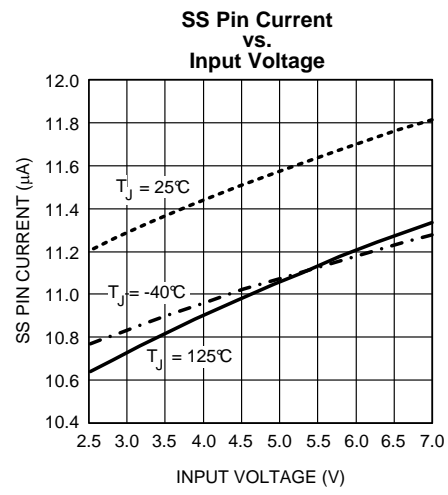

Figure 7.

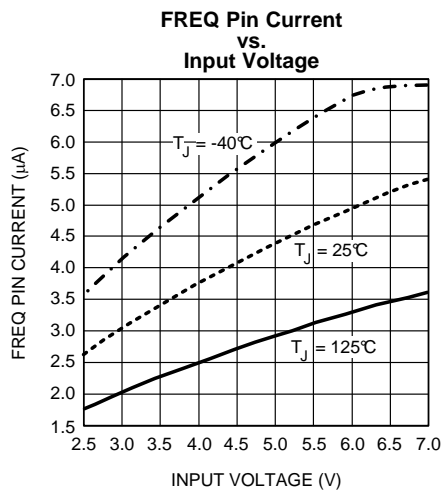

Figure 8.

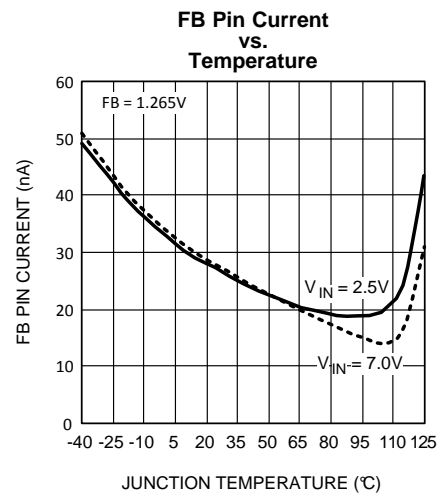

Figure 9.

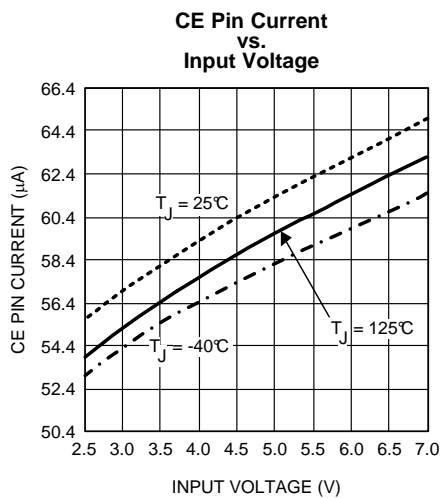

Figure 10.

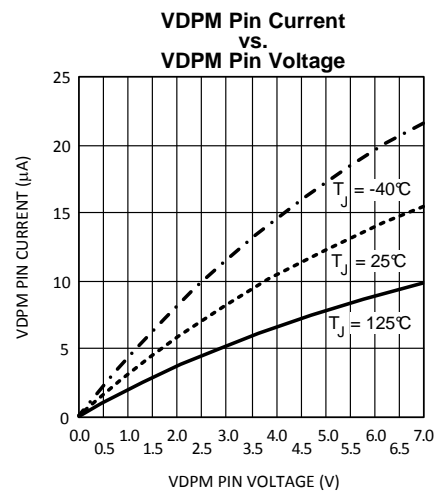

Figure 11.

**Typical Performance Characteristics (continued)**

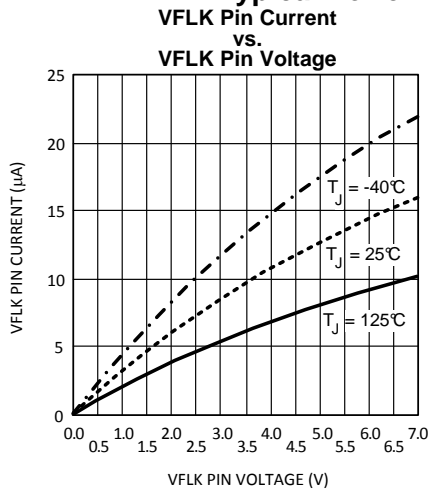

Figure 12.

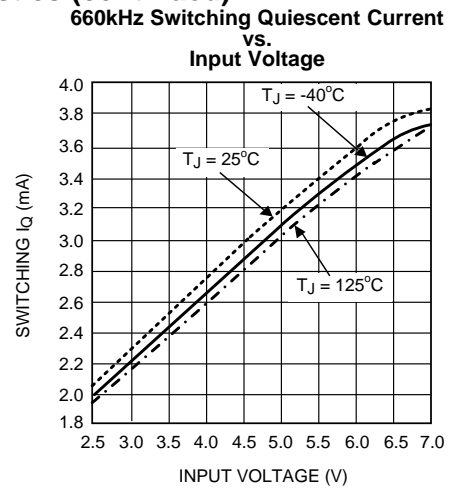

Figure 13.

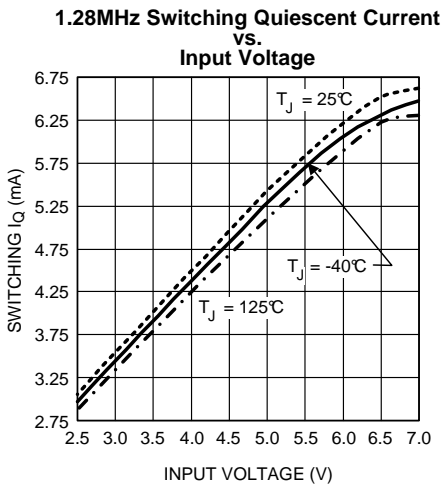

Figure 14.

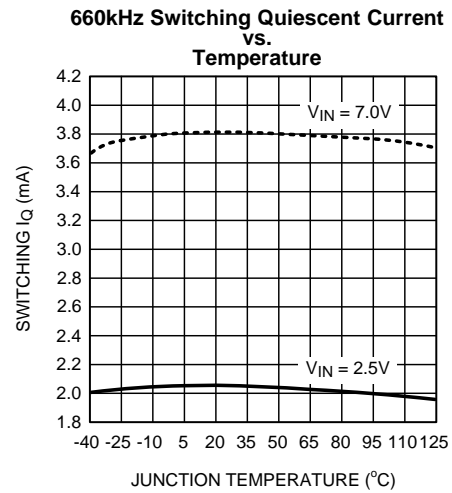

Figure 15.

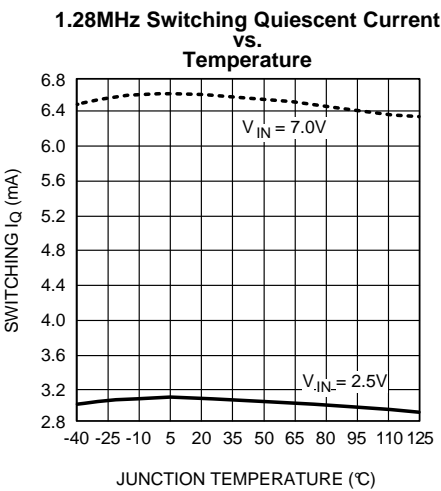

Figure 16.

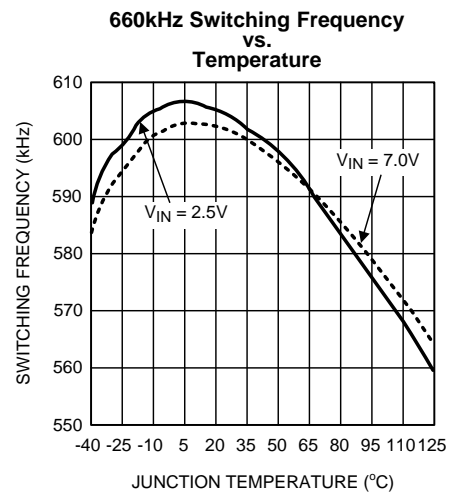

Figure 17.

Typical Performance Characteristics (continued)

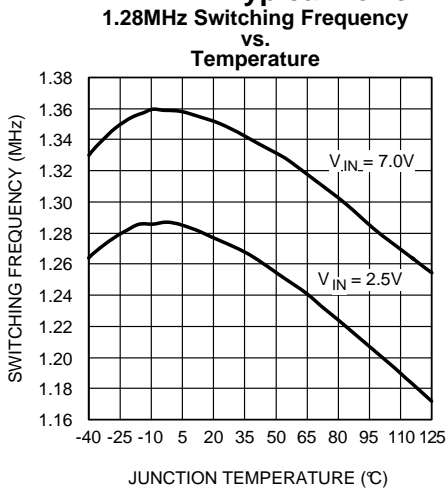

Figure 18.

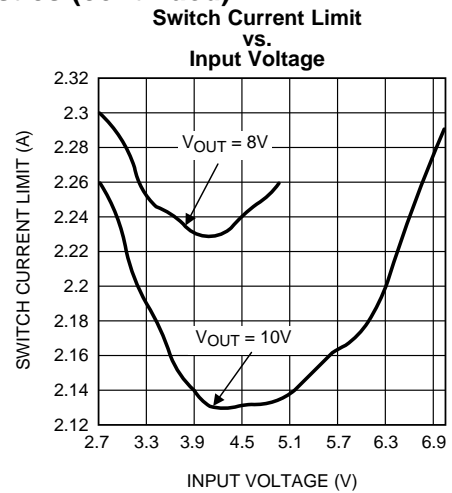

Figure 19.

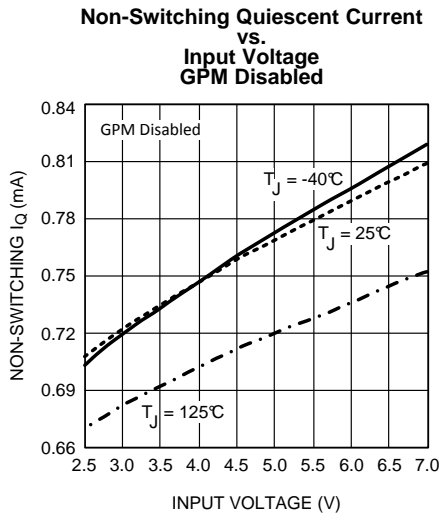

Figure 20.

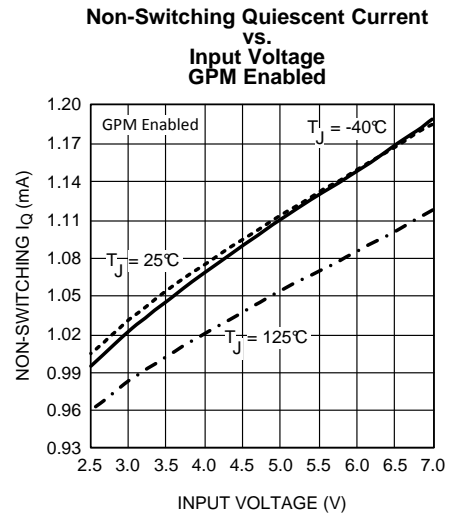

Figure 21.

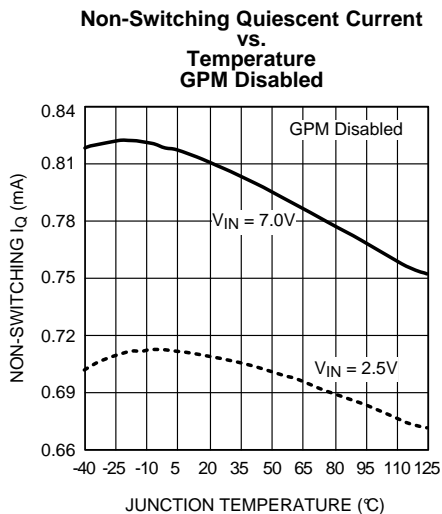

Figure 22.

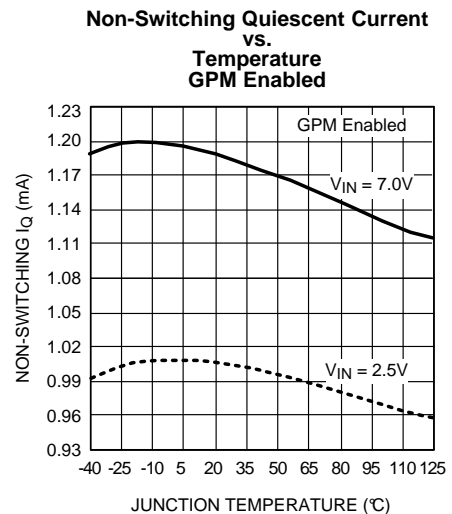

Figure 23.

Typical Performance Characteristics (continued)

Power NMOS  $R_{DS(on)}$  vs. Input Voltage

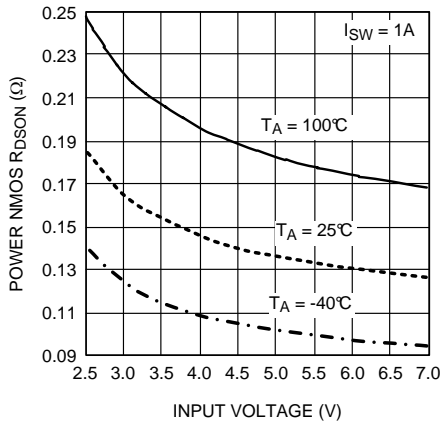

Figure 24.

660kHz Max. Duty Cycle vs. Input Voltage

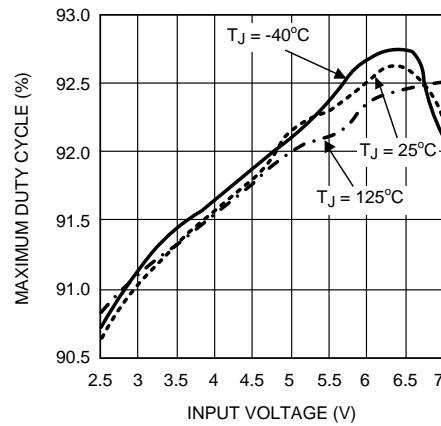

Figure 25.

1.28MHz Max. Duty Cycle vs. Input Voltage

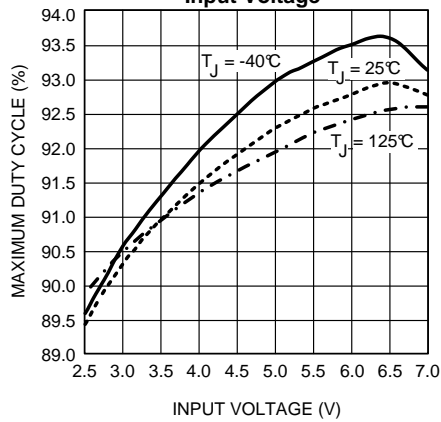

Figure 26.

660kHz Max. Duty Cycle vs. Temperature

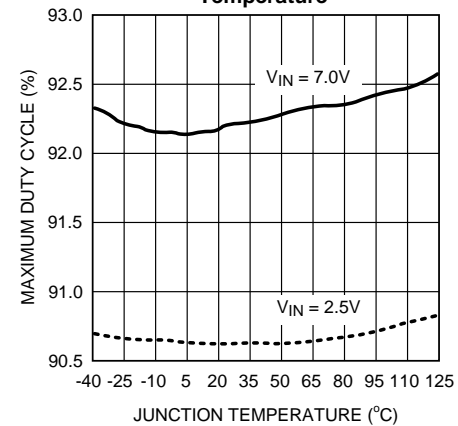

Figure 27.

1.28MHz Max. Duty Cycle vs. Temperature

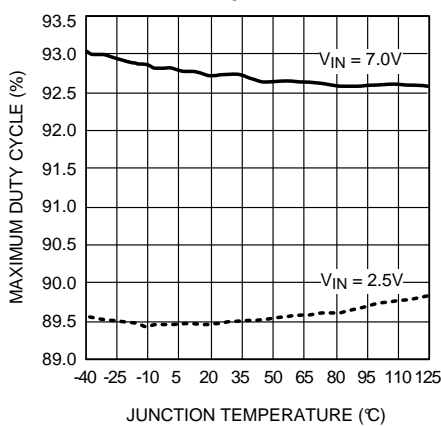

Figure 28.

1.28MHz Application Efficiency

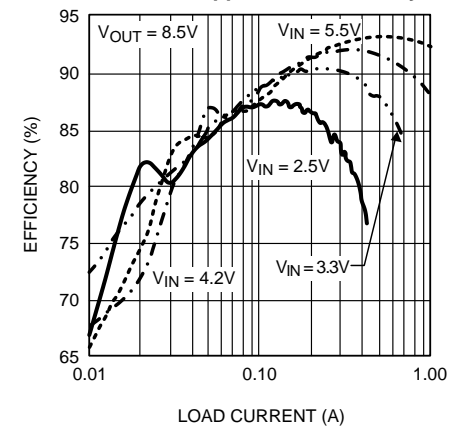

Figure 29.

Typical Performance Characteristics (continued)

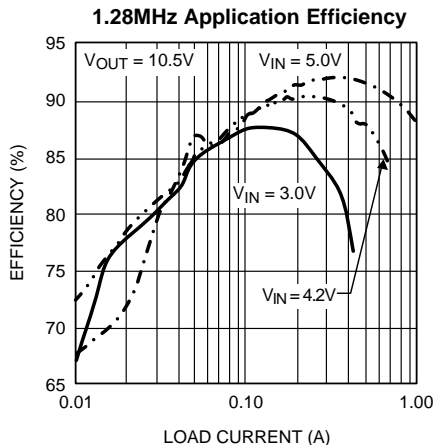

Figure 30.

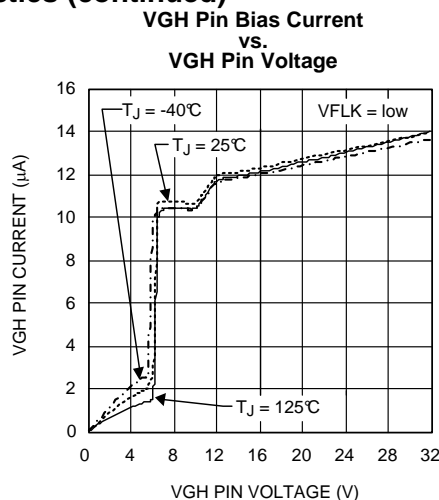

Figure 31.

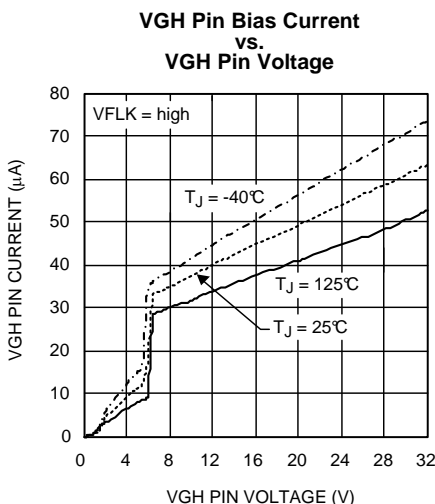

Figure 32.

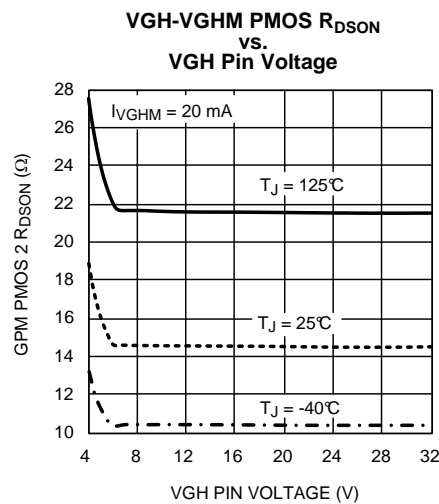

Figure 33.

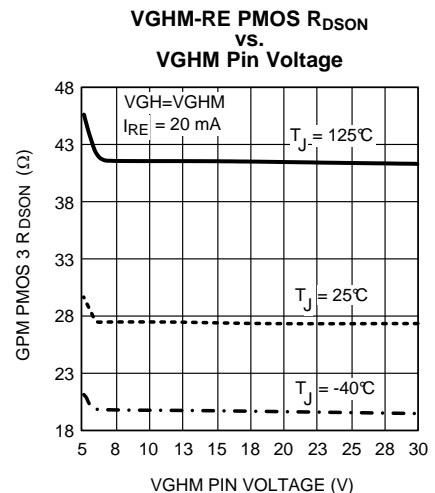

Figure 34.

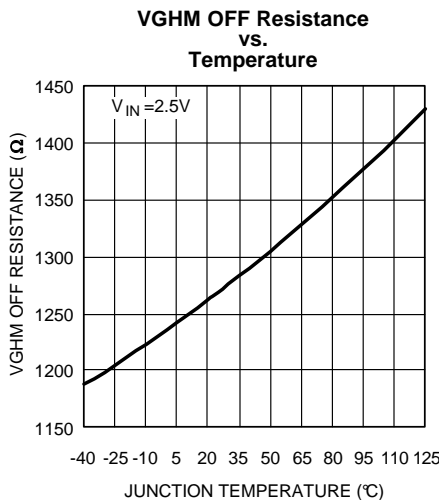

Figure 35.

Typical Performance Characteristics (continued)

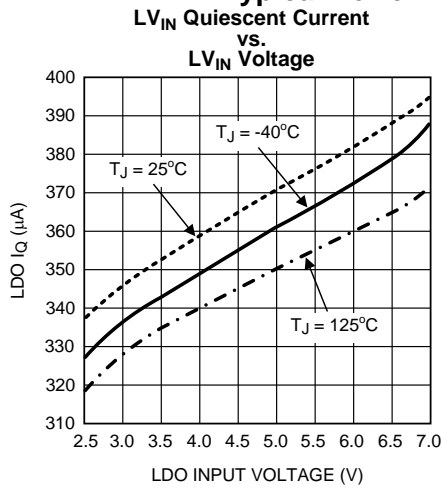

Figure 36.

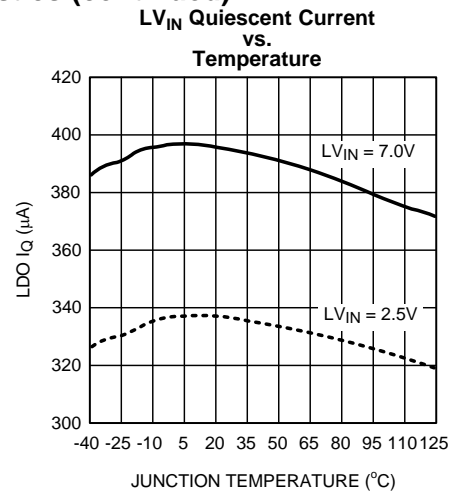

Figure 37.

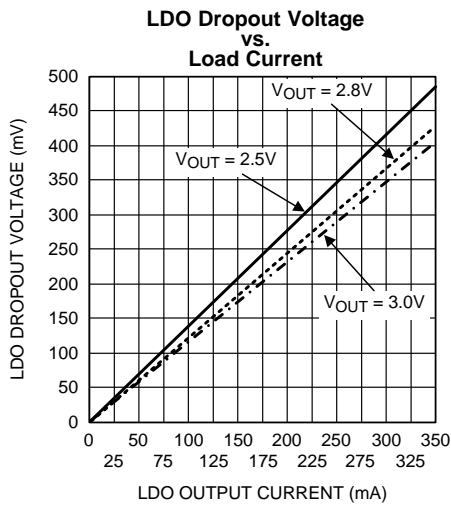

Figure 38.

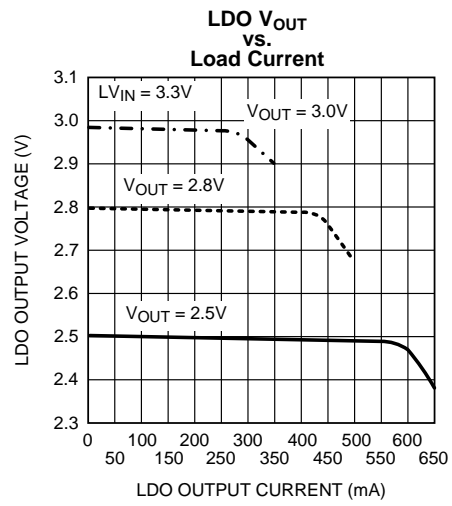

Figure 39.

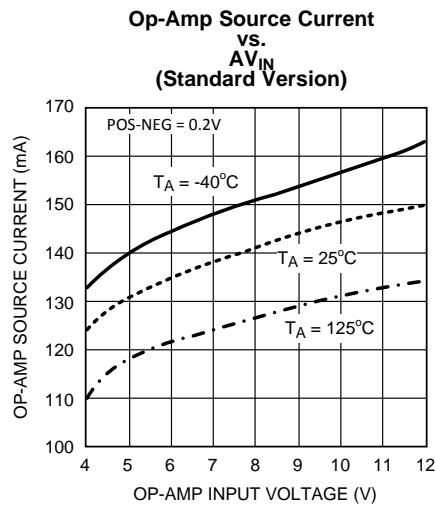

Figure 40.

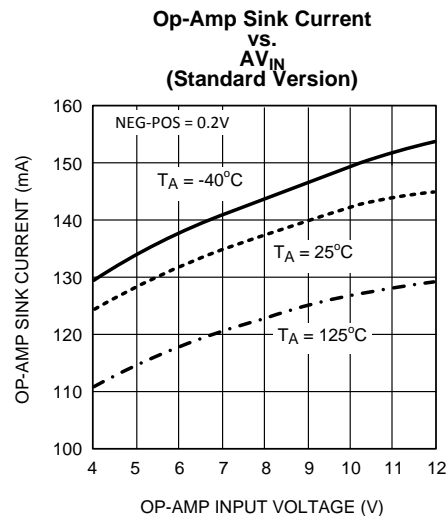

Figure 41.

**Typical Performance Characteristics (continued)**

**Op-Amp Quiescent Current vs.  $AV_{IN}$  (Standard Version)**

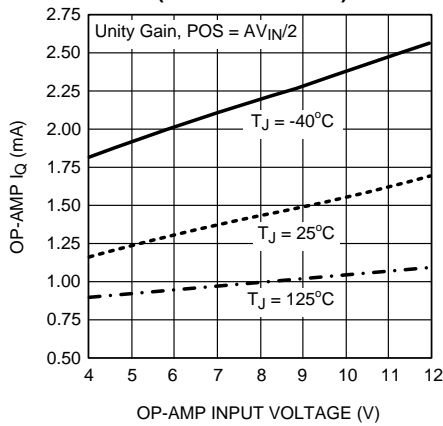

Figure 42.

**Op-Amp Offset Voltage vs.  $AV_{IN}$  (Standard Version, No Load)**

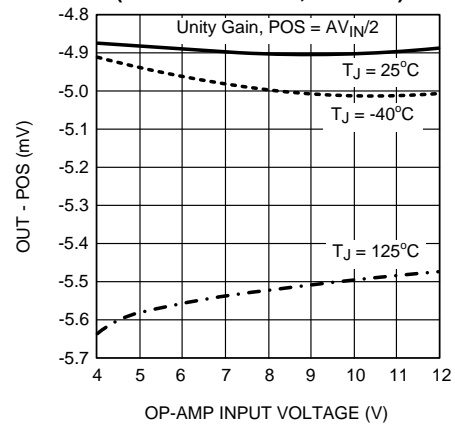

Figure 43.

**Op-Amp Offset Voltage vs. Load Current (Standard Version)**

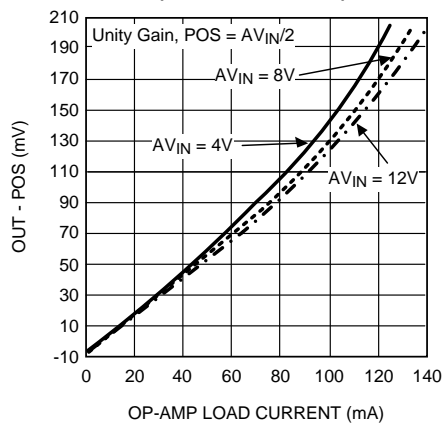

Figure 44.

**1.28MHz, 8.5V Application Boost Load Step**



$V_{OUT} = 8.5V$ ,  $V_{IN} = 3.3V$ ,  $C_{OUT} = 20\mu F$   
 1)  $V_{OUT}$ , 200mV/div, AC  
 3)  $I_{LOAD}$ , 200mA/div, DC  
 $T = 200\mu s/div$

Figure 45.

**1.28MHz, 8.5V Application Boost Startup Waveform**

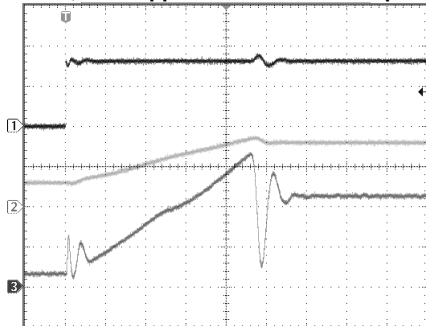

$V_{OUT} = 8.5V$ ,  $V_{IN} = 3.3V$ ,  $C_{OUT} = 20\mu F$ ,  $R_{LOAD} = 20\Omega$ ,  $C_{SS} = 10nF$   
 1)  $V_{SHDN}$ , 2V/div, DC  
 2)  $V_{OUT}$ , 5V/div, DC  
 3)  $I_{IN}$ , 500mA/div, DC  
 $T = 200\mu s/div$

Figure 46.

**1.28MHz, 8.5V Application Boost Startup Waveform**

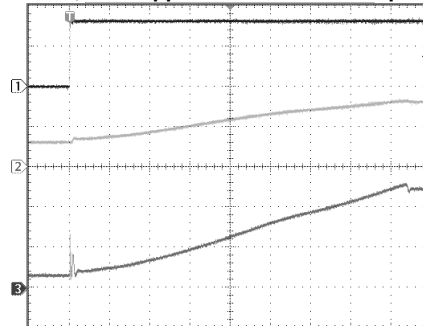

$V_{OUT} = 8.5V$ ,  $V_{IN} = 3.3V$ ,  $C_{OUT} = 20\mu F$ ,  $R_{LOAD} = 20\Omega$ ,  $C_{SS} = 100nF$   
 1)  $V_{SHDN}$ , 2V/div, DC  
 2)  $V_{OUT}$ , 5V/div, DC  
 3)  $I_{IN}$ , 500mA/div, DC  
 $T = 1ms/div$

Figure 47.



**Typical Performance Characteristics (continued)**

**1.28MHz, 8.5V Application Boost Startup Waveform**

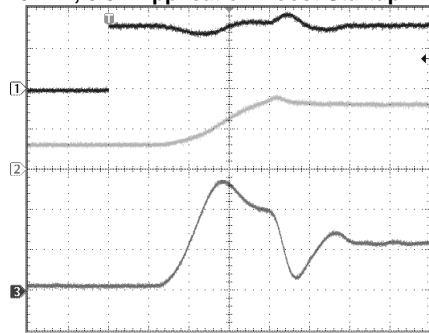

$V_{OUT} = 8.5V$ ,  $V_{IN} = 3.3V$ ,  $C_{OUT} = 20\mu F$ ,  $R_{LOAD} = 20\Omega$ ,  $C_{SS} = \text{open}$   
 1)  $V_{SHDN}$ , 2V/div, DC  
 2)  $V_{OUT}$ , 5V/div, DC  
 3)  $I_{IN}$ , 1A/div, DC  
 T = 40 $\mu s$ /div

**Figure 48.**

**LDO Load Transient Waveform**

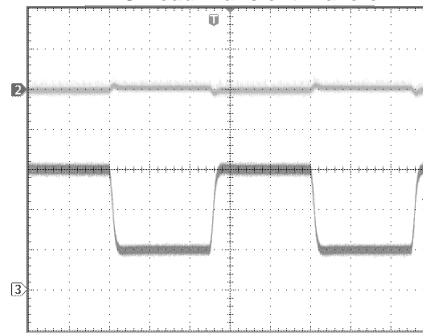

$LDO_{OUT} = 2.5V$ ,  $LV_{IN} = 5V$ ,  $C_{OUT} = 2.2\mu F$   
 2)  $LDO_{OUT}$ , 100mV/div, AC  
 3)  $I_{LOAD}$ , 100mA/div, DC  
 T = 200 $\mu s$ /div

**Figure 49.**

**LDO Startup Waveform (LV\_IN Fast Rising Edge)**

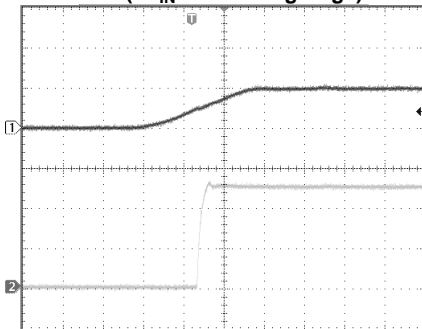

$LDO_{OUT} = 2.5V$ ,  $LV_{IN} = 5V$ ,  $C_{OUT} = 2.2\mu F$ ,  $I_{LOAD} = 300mA$   
 1)  $LV_{IN}$ , 5V/div, DC  
 2)  $LDO_{OUT}$ , 1V/div, DC  
 T = 100 $\mu s$ /div

**Figure 50.**

**LDO Startup Waveform (LV\_IN Slow Rising Edge)**

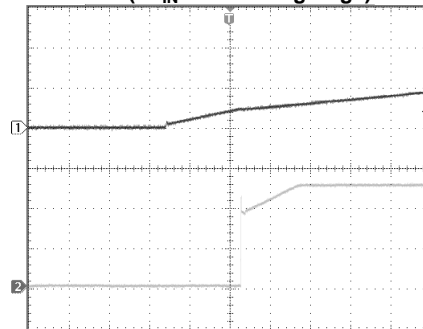

$LDO_{OUT} = 2.5V$ ,  $LV_{IN} = 5V$ ,  $C_{OUT} = 2.2\mu F$ ,  $I_{LOAD} = 300mA$   
 1)  $LV_{IN}$ , 5V/div, DC  
 2)  $LDO_{OUT}$ , 1V/div, DC  
 T = 4ms/div

**Figure 51.**

**GPM Transient Waveforms**

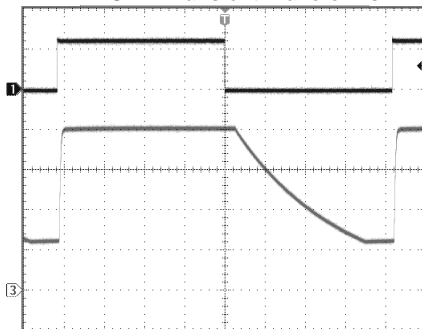

$V_{GH} = 20V$ ,  $V_{DPM} = 3.3V$ ,  $C_{VGHM} = 4.7nF$ ,  $R_E = 2.4k\Omega$ ,  $C_E = 33pF$ ,  
 $R_1 = 13k\Omega$ ,  $R_2 = 1.2k\Omega$ , VFLK at 50% duty cycle and 30kHz  
 1) VFLK, 2V/div, DC  
 3) VGHM, 5V/div, DC  
 T = 4 $\mu s$ /div

**Figure 52.**

**GPM Transient Waveforms**

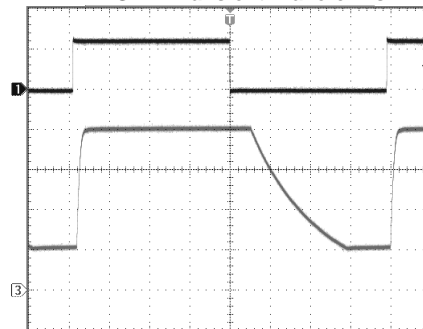

$V_{GH} = 20V$ ,  $V_{DPM} = 3.3V$ ,  $C_{VGHM} = 4.7nF$ ,  $R_E = 750\Omega$ ,  $C_E = 33pF$ ,  
 $R_1 = 13k\Omega$ ,  $R_2 = 1.2k\Omega$ , VFLK at 50% duty cycle and 64kHz  
 1) VFLK, 2V/div, DC  
 3) VGHM, 5V/div, DC  
 T = 2 $\mu s$ /div

**Figure 53.**

## Typical Performance Characteristics (continued)

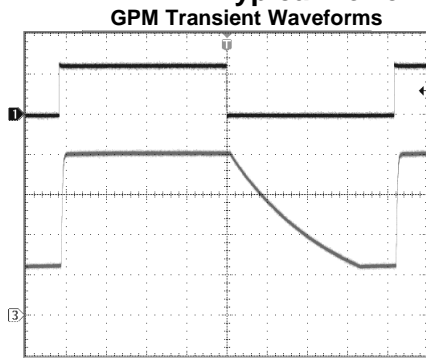

VGH = 20V, VDPM = 3.3V,  $C_{VGHM} = 4.7\text{nF}$ ,  $R_E = 2.4\text{k}\Omega$ ,  $C_E = \text{open}$ ,  
 $R_1 = 13\text{k}\Omega$ ,  $R_2 = 1.2\text{k}\Omega$ , VFLK at 50% duty cycle and 30kHz

1) VFLK, 2V/div, DC  
 3) VGHM, 5V/div, DC  
 $T = 4\mu\text{s/div}$

**Figure 54.**

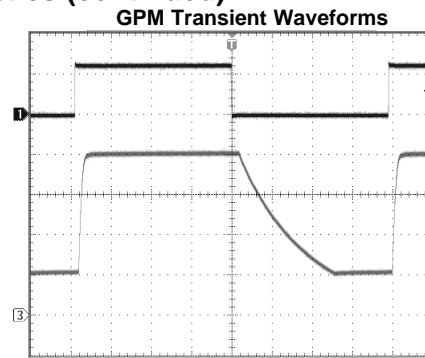

VGH = 20V, VDPM = 3.3V,  $C_{VGHM} = 4.7\text{nF}$ ,  $R_E = 750\Omega$ ,  $C_E = \text{open}$ ,  
 $R_1 = 13\text{k}\Omega$ ,  $R_2 = 1.2\text{k}\Omega$ , VFLK at 50% duty cycle and 64kHz

1) VFLK, 2V/div, DC  
 3) VGHM, 5V/div, DC  
 $T = 2\mu\text{s/div}$

**Figure 55.**

OPERATION

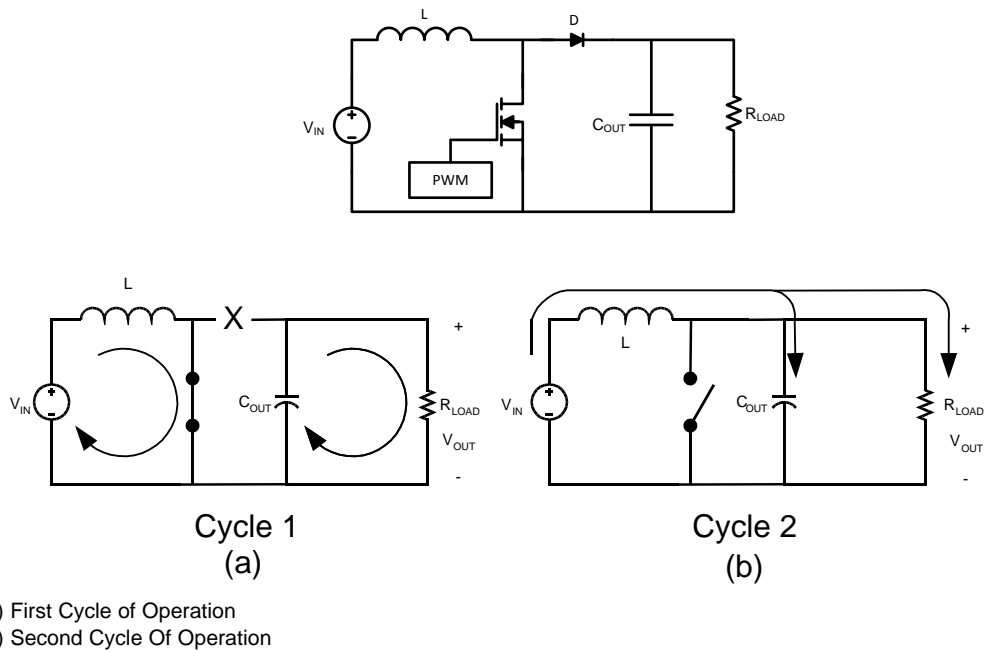

Figure 56. Simplified Boost Converter Diagram

CONTINUOUS CONDUCTION MODE

The LM3311 contains a current-mode, PWM boost regulator. A boost regulator steps the input voltage up to a higher output voltage. In continuous conduction mode (when the inductor current never reaches zero at steady state), the boost regulator operates in two cycles.

In the first cycle of operation, shown in Figure 56 (a), the transistor is closed and the diode is reverse biased. Energy is collected in the inductor and the load current is supplied by C<sub>OUT</sub>.

The second cycle is shown in Figure 56 (b). During this cycle, the transistor is open and the diode is forward biased. The energy stored in the inductor is transferred to the load and output capacitor.

The ratio of these two cycles determines the output voltage. The output voltage is defined approximately as:

$$V_{OUT} = \frac{V_{IN}}{1-D}, D' = (1-D) = \frac{V_{IN}}{V_{OUT}}$$

where

- D is the duty cycle of the switch
  - D and D' will be required for design calculations
- (1)

SETTING THE OUTPUT VOLTAGE (BOOST CONVERTER AND LDO)

The output voltage is set using the feedback pin and a resistor divider connected to the output as shown in the Typical Application Circuit. The feedback pin voltage is 1.263V for both the boost regulator and the LDO, so the ratio of the feedback resistors sets the output voltage according to the following equations:

$$R_{FB1} = R_{FB2} \times \frac{V_{OUT} - 1.263}{1.263} \Omega \text{ (Boost)}$$

(2)

$$R_{ADJ1} = R_{ADJ2} \times \frac{LDO \text{ out} - 1.263}{1.263} \Omega \text{ (LDO)}$$

(3)

## SOFT-START CAPACITOR

The LM3311 has a soft-start pin that can be used to limit the inductor inrush current on start-up. The external SS pin is used to tailor the soft-start for a specific application (see the [LINEAR REGULATOR \(LDO\)](#) section for the minimum value of  $C_{SS}$ ). When used, a current source charges the external soft-start capacitor  $C_{SS}$  until it reaches its typical clamp voltage,  $V_{SS}$ . The soft-start time can be estimated as:

$$T_{SS} = C_{SS} * V_{SS} / I_{SS} \quad (4)$$

## THERMAL SHUTDOWN

The LM3311 includes thermal shutdown. If the die temperature reaches 145°C the device will shut down until it cools to a safe temperature at which point the device will resume operation. If the adverse condition that is heating the device is not removed (ambient temperature too high, short circuit conditions, etc...) the device will continue to cycle on and off to keep the die temperature below 145°C. The thermal shutdown has approximately 20°C of hysteresis. When in thermal shutdown the boost regulator, LDO, Op-Amp, and GPM blocks will all be disabled.

## INPUT UNDER-VOLTAGE PROTECTION

The LM3311 includes input under-voltage protection (UVP). The purpose of the UVP is to protect the device both during start-up and during normal operation from trying to operate with insufficient input voltage. During start-up using a ramping input voltage the UVP circuitry ensures that the device does not begin switching until the input voltage reaches the UVP On threshold. If the input voltage is present and the shutdown pin is pulled high the UVP circuitry will prevent the device from switching if the input voltage present is lower than the UVP On threshold. During normal operation the UVP circuitry will disable the device if the input voltage falls below the UVP Off threshold for any reason. In this case the device will not turn back on until the UVP On threshold voltage is exceeded.

## LINEAR REGULATOR (LDO)

The LM3311 includes a Low Dropout Linear Regulator. The LDO is designed to operate with ceramic input and output capacitors with values as low as 2.2µF. The efficiency of the LDO is approximately the output voltage divided by the input voltage. When using higher input voltages special care should be taken to not dissipate too much power and cause excessive heating of the die. The power dissipated in the LDO section is approximately:

$$P_{D(LDO)} = (V_{IN} - V_{OUT}) * I_{OUT} \quad (5)$$

The LDO has an output undervoltage lockout feature. This feature is to ensure the LDO will shut itself down in the event of an output overload or short condition. When the output is overloaded the output voltage will fall causing the ADJ voltage to fall. When the ADJ voltage falls to  $V_{ADJ(LOW)}$  the LDO will shut off. In this event the SHDN pin or the input UVP must be cycled to turn the LDO back on.

The LDO output undervoltage lockout is controlled by the SS voltage. The LDO startup time must be less than the following:

$$T_S = C_{SS} * 0.5V / I_{SS} \quad (6)$$

When SS is less than 0.5V the output undervoltage lockout is disabled and allows the LDO to start up. When SS is greater than 0.5V the undervoltage lockout is active. If the LDO feedback voltage is not greater than  $V_{ADJ(LOW)}$  when SS reaches 0.5V the LDO may enter an undervoltage lockout condition. In most cases  $C_{SS} = 10nF$  or greater is sufficient. If a supply other than that used to power  $V_{IN}$  is used to power  $LV_{IN}$  care must be taken to apply the input voltage to  $LV_{IN}$  prior to applying voltage to  $V_{IN}$ .

## OPERATIONAL AMPLIFIER

### Compensation:

The architecture used for the amplifier in the LM3311 requires external compensation on the output. Depending on the equivalent resistive and capacitive distributed load of the TFT-LCD panel, external components at the amplifier outputs may or may not be necessary. If the capacitance presented by the load is equal to or greater than an equivalent distributive load of 50Ω in series with 4.7nF no external components are needed as the TFT-LCD panel will act as compensation itself. Distributed resistive and capacitive loads enhance stability and increase performance of the amplifiers. If the capacitance and resistance presented by the load is less than 50Ω in series with 4.7nF, external components will be required as the load itself will not ensure stability. No external

compensation in this case will lead to oscillation of the amplifier and an increase in power consumption. A good choice for compensation in this case is to add a 50Ω in series with a 4.7nF capacitor from the output of the amplifier to ground. This allows for driving zero to infinite capacitance loads with no oscillations, minimal overshoot, and a higher slew rate than using a single large capacitor. The high phase margin created by the external compensation will ensure stability and good performance for all conditions.

#### Layout and Filtering considerations:

When the power supply for the amplifier ( $AV_{IN}$ ) is connected to the output of the switching regulator, the output ripple of the regulator will produce ripple at the output of the amplifiers. This can be minimized by directly bypassing the  $AV_{IN}$  pin to ground with a low ESR ceramic capacitor. For best noise reduction a resistor on the order of 5Ω to 20Ω from the supply being used to the  $AV_{IN}$  pin will create an RC filter and give you a cleaner supply to the amplifier. The bypass capacitor should be placed as close to the  $AV_{IN}$  pin as possible and connected directly to the AGND plane.

For best noise immunity all bias and feedback resistors should be in the low kΩ range due to the high input impedance of the amplifier. It is good practice to use a small capacitance at the high impedance input terminals as well to reduce noise susceptibility. All resistors and capacitors should be placed as close to the input pins as possible.

Special care should also be taken in routing of the PCB traces. All traces should be as short and direct as possible. The output pin trace must never be routed near any trace going to the positive input. If this happens cross talk from the output trace to the positive input trace will cause the circuit to oscillate.

The op-amp is not a three terminal device it has 5 terminals: positive voltage power pin, AGND, positive input, negative input, and the output. The op-amp "routes" current from the power pin and AGND to the output pin. So in effect an opamp has not two inputs but four, all of which must be kept noise free relative to the external circuits which are being driven by the op-amp. The current from the power pins goes through the output pin and into the load and feedback loop. The current exiting the load and feedback loops then must have a return path back to the op-amp power supply pins. Ideally this return path must follow the same path as the output pin trace to the load. Any deviation that makes the loop area larger between the output current path and the return current path adds to the probability of noise pick up.

### GATE PULSE MODULATION

The Gate Pulse Modulation (GPM) block is designed to provide a modulated voltage to the gate driver circuitry of a TFT LCD display. Operation is best understood by referring to the GPM block diagram in the [Block Diagrams](#) section, the drawing in [Figure 57](#) and the transient waveforms in [Figure 58](#) and [Figure 59](#).

There are two control signals in the GPM block, VDPM and VFLK. VDPM is the enable pin for the GPM block. If VDPM is high, the GPM block is active and will respond to the VFLK drive signal from the timing controller. However, if VDPM is low, the GPM block will be disabled and both PMOS switches P2 and P3 will be turned off. The VGHM node will be discharged through a 1kΩ resistor and the NMOS switch N2.

When VDPM is high, typical waveforms for the GPM block can be seen in [Figure 57](#). The pin VGH is typically driven by a 2x or 3x charge pump. In most cases, the 2x or 3x charge pump is a discrete solution driven from the SW pin and the output of the boost switching regulator. When VFLK is high, the PMOS switch P2 is turned on and the PMOS switch P3 is turned off. With P2 on, the VGHM pin is pulled to the same voltage applied to the VGH pin. This provides a high gate drive voltage,  $VGH_{MAX}$ , and can source current to the gate drive circuitry. When VFLK is high, NMOS switch N3 is on which discharges the capacitor CE.

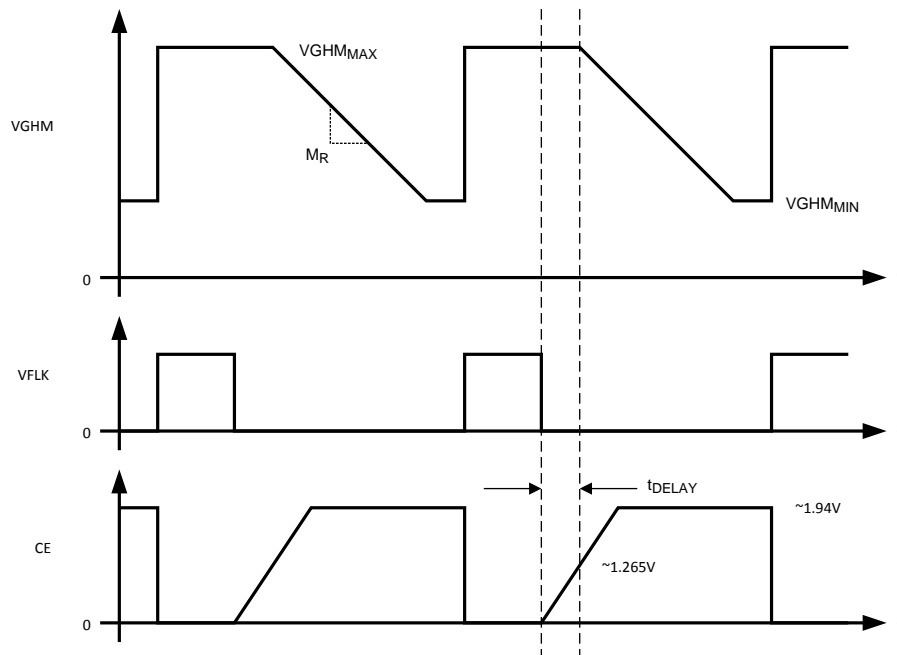

Figure 57.

When VFLK is low, the NMOS switch N3 is turned off which allows current to charge the  $C_E$  capacitor. This creates a delay,  $t_{DELAY}$ , given by the following equations:

$$t_{DELAY} \approx 1.265V(C_E + 15pF)/I_{CE} \quad (7)$$

When the voltage on CE reaches about 1.265V and the VFLK signal is low, the PMOS switch P2 will turn off and the PMOS switch P3 will turn on connecting resistor R3 to the VGHM pin through P3. This will discharge the voltage at VGHM at some rate determined by R3 creating a slope,  $M_R$ , as shown in Figure 57. The VGHM pin is no longer a current source, it is now sinking current from the gate drive circuitry.

As VGHM is discharged through R3, the comparator connected to the pin  $V_{DD}$  monitors the VGHM voltage. PMOS switch P3 will turn off when the following is true:

$$VGHM_{MIN} \approx 10V_X R2 / (R1 + R2)$$

where

- $V_X$  is some voltage connected to the resistor divider on pin  $V_{DD}$  (8)

$V_X$  is typically connected to the output of the boost switching regulator. When PMOS switch P3 turns off, VGHM will be high impedance until the VFLK pin is high again.

Figure 58 and Figure 59 give typical transient waveforms for the GPM block. Waveform (1) is the VGHM pin, (2) is the VFLK and (3) is the VDPM. The output of the boost switching regulator is operating at 8.5V and there is a 3x discrete charge pump (~23.5V) supplying the VGH pin. In Figure 58 and Figure 59, the VGHM pin is driving a purely capacitive load, 4.7nF. The value of resistor R1 is 15kohm, R2 is 1.1k $\Omega$  and R3 is 750 $\Omega$ . In both transient plots, there is no  $C_E$  delay capacitor.

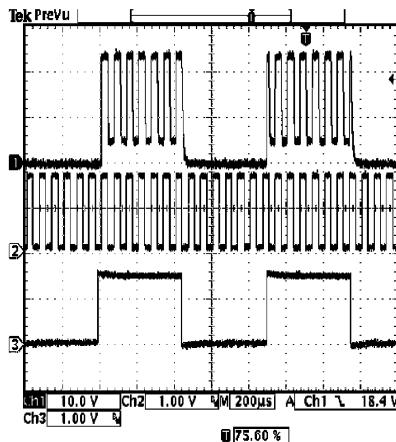

Figure 58. Waveform

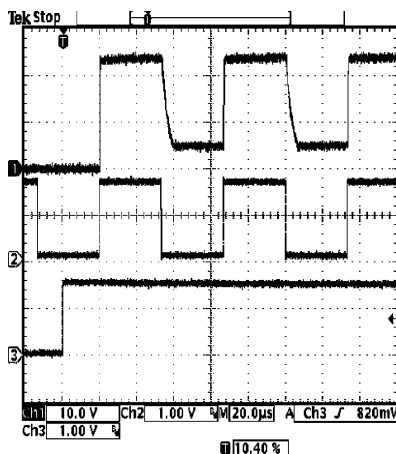
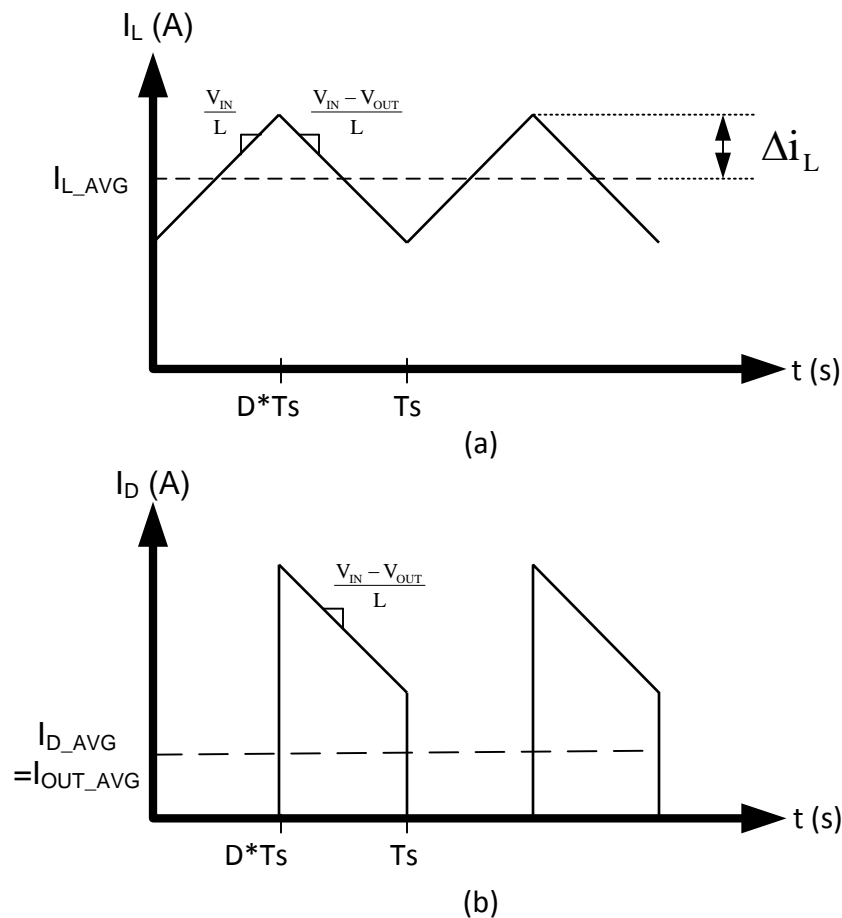

Figure 59. Waveform

In the GPM block diagram, a signal called “Reset” is shown. This signal is generated from the  $V_{IN}$  under-voltage lockout, thermal shutdown, or the  $\overline{SHDN}$  pin. If the  $V_{IN}$  supply voltage drops below 2.3V, typically, then the GPM block will be disabled and the VGHM pin will discharge through NMOS switch N2 and the 1k $\Omega$  resistor. This applies also if the junction temperature of the device exceeds 145°C or if the  $\overline{SHDN}$  signal is low. As shown in the [Block Diagrams](#), both VDPM and VFLK have internal 350k $\Omega$  pull down resistors. This puts both VDPM and VFLK in normally “off” states. Typical VDPM and VFLK pin currents can be found in the [Typical Performance Characteristics](#) section.

## INTRODUCTION TO COMPENSATION (BOOST CONVERTER)



(a) Inductor current  
(b) Diode current

**Figure 60.**

The LM3311 is a current mode PWM boost converter. The signal flow of this control scheme has two feedback loops, one that senses switch current and one that senses output voltage.

To keep a current programmed control converter stable above duty cycles of 50%, the inductor must meet certain criteria. The inductor, along with input and output voltage, will determine the slope of the current through the inductor (see [Figure 60](#) (a)). If the slope of the inductor current is too great, the circuit will be unstable above duty cycles of 50%. A 10 $\mu$ H inductor is recommended for most 660 kHz applications, while a 4.7 $\mu$ H inductor may be used for most 1.28 MHz applications. If the duty cycle is approaching the maximum of 85%, it may be necessary to increase the inductance by as much as 2X. See [INDUCTOR AND DIODE SELECTION](#) for more detailed inductor sizing.

The LM3311 provides a compensation pin ( $V_C$ ) to customize the voltage loop feedback. It is recommended that a series combination of  $R_C$  and  $C_C$  be used for the compensation network, as shown in the [Typical Application Circuit](#). For any given application, there exists a unique combination of  $R_C$  and  $C_C$  that will optimize the performance of the LM3311 circuit in terms of its transient response. The series combination of  $R_C$  and  $C_C$  introduces a pole-zero pair according to the following equations:



$$f_{zC} = \frac{1}{2\pi R_C C_C} \text{ Hz} \quad (9)$$

$$f_{pC} = \frac{1}{2\pi(R_C + R_O)C_C} \text{ Hz}$$

where

- $R_O$  is the output impedance of the error amplifier, approximately 900k $\Omega$  (10)

For most applications, performance can be optimized by choosing values within the range  $5k\Omega \leq R_C \leq 100k\Omega$  ( $R_C$  can be higher values if  $C_{C2}$  is used, see [HIGH OUTPUT CAPACITOR ESR COMPENSATION](#)) and  $68pF \leq C_C \leq 4.7nF$ . Refer to the [Application Information](#) section for recommended values for specific circuits and conditions. Refer to the [COMPENSATION](#) section for other design requirement.

## COMPENSATION

This section will present a general design procedure to help insure a stable and operational circuit. The designs in this datasheet are optimized for particular requirements. If different conversions are required, some of the components may need to be changed to ensure stability. Below is a set of general guidelines in designing a stable circuit for continuous conduction operation, in most all cases this will provide for stability during discontinuous operation as well. The power components and their effects will be determined first, then the compensation components will be chosen to produce stability.

## INDUCTOR AND DIODE SELECTION

Although the inductor sizes mentioned earlier are fine for most applications, a more exact value can be calculated. To ensure stability at duty cycles above 50%, the inductor must have some minimum value determined by the minimum input voltage and the maximum output voltage. This equation is:

$$L > \frac{V_{IN} R_{DS(ON)}}{0.144 f_s} \left[ \frac{D}{D'} - 1 \right] \text{ (in H)}$$

where

- $f_s$  is the switching frequency
- $D$  is the duty cycle
- $R_{DS(ON)}$  is the ON resistance of the internal power switch (11)

This equation is only good for duty cycles greater than 50% ( $D > 0.5$ ), for duty cycles less than 50% the recommended values may be used. The value given by this equation is the inductance necessary to suppress sub-harmonic oscillations. In some cases the value given by this equation may be too small for a given application. In this case the average inductor current and the inductor current ripple must be considered.

The corresponding inductor current ripple, average inductor current, and peak inductor current as shown in [Figure 60 \(a\)](#) is given by:

$$\Delta i_L = \frac{V_{IN} D}{2L f_s} \text{ (in Amps)} \quad (12)$$

$$i_{L(AVE)} \approx \frac{I_{OUT}}{\eta D'} \quad (13)$$

$$i_{L(PEAK)} \approx i_{L(AVE)} + \Delta i_L \quad (14)$$

Continuous conduction mode occurs when  $\Delta i_L$  is less than the average inductor current and discontinuous conduction mode occurs when  $\Delta i_L$  is greater than the average inductor current. Care must be taken to make sure that the switch will not reach its current limit during normal operation. The inductor must also be sized accordingly. It should have a saturation current rating higher than the peak inductor current expected. The output voltage ripple is also affected by the total ripple current.

The output diode for a boost regulator must be chosen correctly depending on the output voltage and the output current. The typical current waveform for the diode in continuous conduction mode is shown in [Figure 60](#) (b). The diode must be rated for a reverse voltage equal to or greater than the output voltage used. The average current rating must be greater than the maximum load current expected, and the peak current rating must be greater than the peak inductor current. During short circuit testing, or if short circuit conditions are possible in the application, the diode current rating must exceed the switch current limit. Using Schottky diodes with lower forward voltage drop will decrease power dissipation and increase efficiency.

## DC GAIN AND OPEN-LOOP GAIN

Since the control stage of the converter forms a complete feedback loop with the power components, it forms a closed-loop system that must be stabilized to avoid positive feedback and instability. A value for open-loop DC gain will be required, from which you can calculate, or place, poles and zeros to determine the crossover frequency and the phase margin. A high phase margin (greater than 45°) is desired for the best stability and transient response. For the purpose of stabilizing the LM3311, choosing a crossover point well below where the right half plane zero is located will ensure sufficient phase margin.

To ensure a bandwidth of ½ or less of the frequency of the RHP zero, calculate the open-loop DC gain,  $A_{DC}$ . After this value is known, you can calculate the crossover visually by placing a -20dB/decade slope at each pole, and a +20dB/decade slope for each zero. The point at which the gain plot crosses unity gain, or 0dB, is the crossover frequency. If the crossover frequency is less than ½ the RHP zero, the phase margin should be high enough for stability. The phase margin can also be improved by adding  $C_{C2}$  as discussed later in this section. The equation for  $A_{DC}$  is given below with additional equations required for the calculation:

$$A_{DC(DB)} = 20 \log_{10} \left( \left( \frac{R_{FB2}}{R_{FB1} + R_{FB2}} \right) \frac{g_m R_o D'}{R_{DSON}} \left\{ \left[ \frac{\omega C L_{eff}}{R_L} \right] / R_L \right\} \right) \text{ (in dB)}$$

where

- $R_L$  is the minimum load resistance
- $g_m$  is the error amplifier transconductance found in the [Electrical Characteristics](#) table (15)

$$\omega_C \cong \frac{2f_s}{nD'} \text{ (in rad/s)} \quad (16)$$

$$L_{eff} = \frac{L}{(D')^2} \quad (17)$$

$$n = 1 + \frac{2mc}{m1} \text{ (no unit)} \quad (18)$$

$$mc \cong 0.072f_s \text{ (in V/s)} \quad (19)$$

$$m1 \cong \frac{V_{IN} R_{DSON}}{L} \text{ (in V/s)}$$

- $V_{IN}$  is the minimum input voltage
- $R_{DSON}$  is the value chosen from the graph "NMOS  $R_{DSON}$  vs. Input Voltage" in the [Typical Performance Characteristics](#) (20)

## INPUT AND OUTPUT CAPACITOR SELECTION

The switching action of a boost regulator causes a triangular voltage waveform at the input. A capacitor is required to reduce the input ripple and noise for proper operation of the regulator. The size used is dependant on the application and board layout. If the regulator will be loaded uniformly, with very little load changes, and at lower current outputs, the input capacitor size can often be reduced. The size can also be reduced if the input of the regulator is very close to the source output. The size will generally need to be larger for applications where the regulator is supplying nearly the maximum rated output or if large load steps are expected. A minimum value of 10µF should be used for the less stressful conditions while a 22µF to 47µF capacitor may be required for higher power and dynamic loads. Larger values and/or lower ESR may be needed if the application requires very low ripple on the input source voltage.

The choice of output capacitors is also somewhat arbitrary and depends on the design requirements for output voltage ripple. It is recommended that low ESR (Equivalent Series Resistance, denoted  $R_{ESR}$ ) capacitors be used such as ceramic, polymer electrolytic, or low ESR tantalum. Higher ESR capacitors may be used but will require more compensation which will be explained later on in the section. The ESR is also important because it determines the peak to peak output voltage ripple according to the approximate equation:

$$\Delta V_{OUT} \approx 2\Delta I_L R_{ESR} \text{ (in Volts)} \quad (21)$$

A minimum value of 10 $\mu$ F is recommended and may be increased to a larger value. After choosing the output capacitor you can determine a pole-zero pair introduced into the control loop by the following equations:

$$f_{P1} = \frac{1}{2\pi(R_{ESR} + R_L)C_{OUT}} \text{ (in Hz)}$$

where

- $R_L$  is the minimum load resistance corresponding to the maximum load current (22)

$$f_{Z1} = \frac{1}{2\pi R_{ESR} C_{OUT}} \text{ (in Hz)} \quad (23)$$

The zero created by the ESR of the output capacitor is generally very high frequency if the ESR is small. If low ESR capacitors are used it can be neglected. If higher ESR capacitors are used see the [HIGH OUTPUT CAPACITOR ESR COMPENSATION](#) section. Some suitable capacitor vendors include Vishay, Taiyo-Yuden, and TDK.

## RIGHT HALF PLANE ZERO

A current mode control boost regulator has an inherent right half plane zero (RHP zero). This zero has the effect of a zero in the gain plot, causing an imposed +20dB/decade on the rolloff, but has the effect of a pole in the phase, subtracting another 90° in the phase plot. This can cause undesirable effects if the control loop is influenced by this zero. To ensure the RHP zero does not cause instability issues, the control loop should be designed to have a bandwidth of less than ½ the frequency of the RHP zero. This zero occurs at a frequency of:

$$RHPzero = \frac{V_{OUT}(D')^2}{2\pi I_{LOAD} L} \text{ (in Hz)}$$

where

- $I_{LOAD}$  is the maximum load current (24)

## SELECTING THE COMPENSATION COMPONENTS

The first step in selecting the compensation components  $R_C$  and  $C_C$  is to set a dominant low frequency pole in the control loop. Simply choose values for  $R_C$  and  $C_C$  within the ranges given in the [Introduction to Compensation](#) section to set this pole in the area of 10Hz to 500Hz. The frequency of the pole created is determined by the equation:

$$f_{PC} = \frac{1}{2\pi(R_C + R_O)C_C} \text{ (in Hz)}$$

where

- $R_O$  is the output impedance of the error amplifier, approximately 900k $\Omega$  (25)

Since  $R_C$  is generally much less than  $R_O$ , it does not have much effect on the above equation and can be neglected until a value is chosen to set the zero  $f_{ZC}$ .  $f_{ZC}$  is created to cancel out the pole created by the output capacitor,  $f_{P1}$ . The output capacitor pole will shift with different load currents as shown by the equation, so setting the zero is not exact. Determine the range of  $f_{P1}$  over the expected loads and then set the zero  $f_{ZC}$  to a point approximately in the middle. The frequency of this zero is determined by:

$$f_{ZC} = \frac{1}{2\pi C_C R_C} \text{ (in Hz)} \quad (26)$$

Now  $R_C$  can be chosen with the selected value for  $C_C$ . Check to make sure that the pole  $f_{PC}$  is still in the 10Hz to 500Hz range, change each value slightly if needed to ensure both component values are in the recommended range.

## HIGH OUTPUT CAPACITOR ESR COMPENSATION

When using an output capacitor with a high ESR value, or just to improve the overall phase margin of the control loop, another pole may be introduced to cancel the zero created by the ESR. This is accomplished by adding another capacitor,  $C_{C2}$ , directly from the compensation pin  $V_C$  to ground, in parallel with the series combination of  $R_C$  and  $C_C$ . The pole should be placed at the same frequency as  $f_{Z1}$ , the ESR zero. The equation for this pole follows:

$$f_{PC2} = \frac{1}{2\pi C_{C2}(R_C // R_O)} \text{ (in Hz)} \quad (27)$$

To ensure this equation is valid, and that  $C_{C2}$  can be used without negatively impacting the effects of  $R_C$  and  $C_C$ ,  $f_{PC2}$  must be greater than  $10f_{ZC}$ .

## CHECKING THE DESIGN

With all the poles and zeros calculated the crossover frequency can be checked as described in the section [DC GAIN AND OPEN-LOOP GAIN](#). The compensation values can be changed a little more to optimize performance if desired. This is best done in the lab on a bench, checking the load step response with different values until the ringing and overshoot on the output voltage at the edge of the load steps is minimal. This should produce a stable, high performance circuit. For improved transient response, higher values of  $R_C$  should be chosen. This will improve the overall bandwidth which makes the regulator respond more quickly to transients. If more detail is required, or the most optimum performance is desired, refer to a more in depth discussion of compensating current mode DC/DC switching regulators.

## POWER DISSIPATION

The output power of the LM3311 is limited by its maximum power dissipation. The maximum power dissipation is determined by the formula

$$P_D = (T_{jmax} - T_A) / \theta_{JA}$$

where

- $T_{jmax}$  is the maximum specified junction temperature (125°C)
- $T_A$  is the ambient temperature
- $\theta_{JA}$  is the thermal resistance of the package

(28)

## LAYOUT CONSIDERATIONS

The input bypass capacitor  $C_{IN}$ , as shown in the [Typical Application Circuit](#), must be placed close to the IC. This will reduce copper trace resistance which effects input voltage ripple of the IC. For additional input voltage filtering, a 100nF bypass capacitor can be placed in parallel with  $C_{IN}$ , close to the  $V_{IN}$  pin, to shunt any high frequency noise to ground. The output capacitor,  $C_{OUT}$ , should also be placed close to the IC. Any copper trace connections for the  $C_{OUT}$  capacitor can increase the series resistance, which directly effects output voltage ripple. The feedback network, resistors  $R_{FB1}$  and  $R_{FB2}$ , should be kept close to the FB pin, and away from the inductor, to minimize copper trace connections that can inject noise into the system.  $R_E$  and  $C_E$  should also be close to the RE and CE pins to minimize noise in the GPM circuitry. Trace connections made to the inductor and schottky diode should be minimized to reduce power dissipation and increase overall efficiency. For more detail on switching power supply layout considerations see Application Note AN-1149: *Layout Guidelines for Switching Power Supplies (SNVA021)*.

The input capacitor, output capacitor, and feedback resistors for the LDO should be placed as close to the device as possible to minimize noise and increase stability. Keep the feedback traces short and connect  $R_{ADJ2}$  directly to AGND close to the device.

For Op-Amp layout please refer to the [OPERATIONAL AMPLIFIER](#) section.

[Figure 61](#), [Figure 62](#), and [Figure 63](#) in the [Application Information](#) section following show the schematic and an example of a good layout as used in the LM3310/11 evaluation board.

Application Information

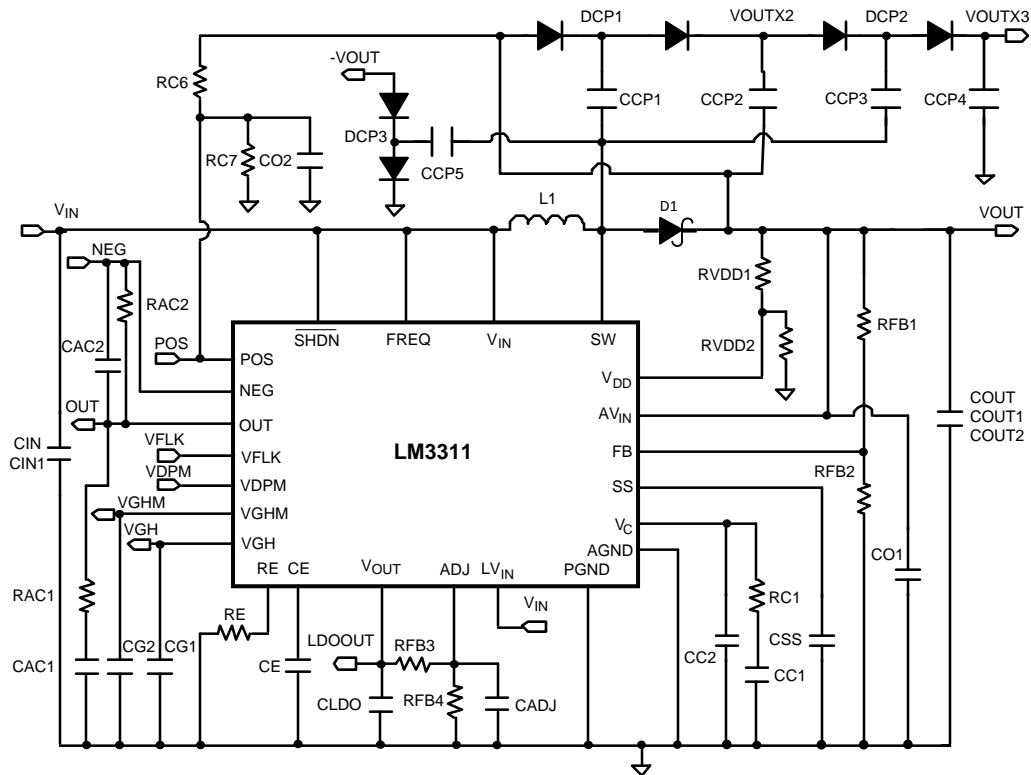

Figure 61. Evaluation Board Schematic

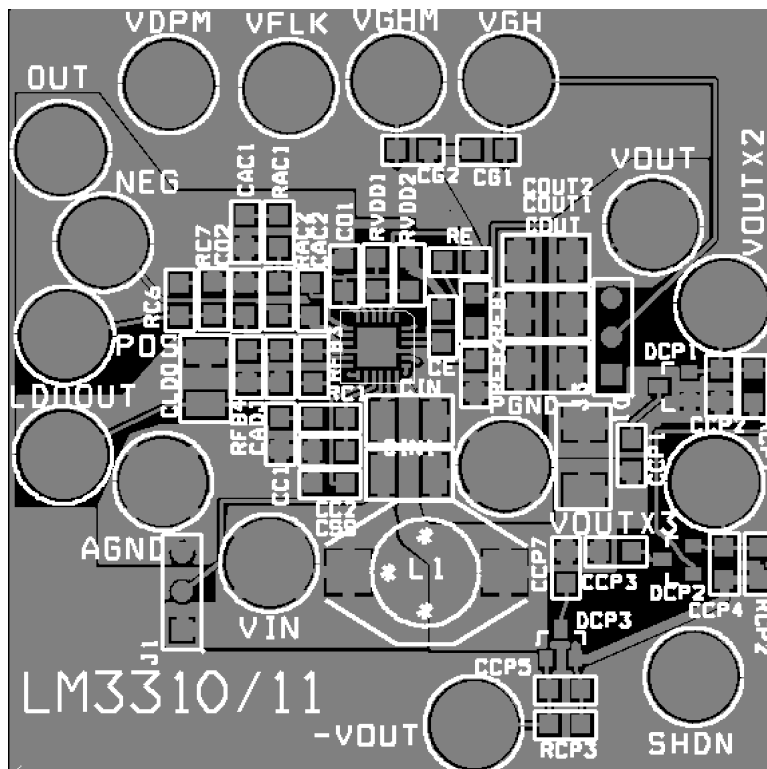

Figure 62. Evaluation Board Layout (top layer)





## REVISION HISTORY

Changes from Revision F (April 2013) to Revision G	Page
• Changed layout of National Data Sheet to TI format .....	<a href="#">31</a>



**PACKAGING INFORMATION**

Orderable Device	Status (1)	Package Type	Package Drawing	Pins	Package Qty	Eco Plan (2)	Lead/Ball Finish	MSL Peak Temp (3)	Op Temp (°C)	Device Marking (4/5)	Samples
LM3311SQ-HIOP	ACTIVE	WQFN	RTW	24		TBD	Call TI	Call TI		L3311HP	<a href="#">Samples</a>
LM3311SQ-HIOP/NOPB	ACTIVE	WQFN	RTW	24	1000	Green (RoHS & no Sb/Br)	CU SN	Level-1-260C-UNLIM		L3311HP	<a href="#">Samples</a>
LM3311SQX	ACTIVE	WQFN	RTW	24		TBD	Call TI	Call TI	-40 to 125	L3311SQ	<a href="#">Samples</a>
LM3311SQX-HIOP	ACTIVE	WQFN	RTW	24		TBD	Call TI	Call TI	-40 to 125	L3311HP	<a href="#">Samples</a>
LM3311SQX-HIOP/NOPB	ACTIVE	WQFN	RTW	24	4500	Green (RoHS & no Sb/Br)	CU SN	Level-1-260C-UNLIM	-40 to 125	L3311HP	<a href="#">Samples</a>
LM3311SQX/NOPB	ACTIVE	WQFN	RTW	24	4500	Green (RoHS & no Sb/Br)	CU SN	Level-1-260C-UNLIM	-40 to 125	L3311SQ	<a href="#">Samples</a>

(1) The marketing status values are defined as follows:

**ACTIVE:** Product device recommended for new designs.

**LIFEBUY:** TI has announced that the device will be discontinued, and a lifetime-buy period is in effect.

**NRND:** Not recommended for new designs. Device is in production to support existing customers, but TI does not recommend using this part in a new design.

**PREVIEW:** Device has been announced but is not in production. Samples may or may not be available.

**OBSOLETE:** TI has discontinued the production of the device.

(2) Eco Plan - The planned eco-friendly classification: Pb-Free (RoHS), Pb-Free (RoHS Exempt), or Green (RoHS & no Sb/Br) - please check <http://www.ti.com/productcontent> for the latest availability information and additional product content details.

**TBD:** The Pb-Free/Green conversion plan has not been defined.

**Pb-Free (RoHS):** TI's terms "Lead-Free" or "Pb-Free" mean semiconductor products that are compatible with the current RoHS requirements for all 6 substances, including the requirement that lead not exceed 0.1% by weight in homogeneous materials. Where designed to be soldered at high temperatures, TI Pb-Free products are suitable for use in specified lead-free processes.

**Pb-Free (RoHS Exempt):** This component has a RoHS exemption for either 1) lead-based flip-chip solder bumps used between the die and package, or 2) lead-based die adhesive used between the die and leadframe. The component is otherwise considered Pb-Free (RoHS compatible) as defined above.

**Green (RoHS & no Sb/Br):** TI defines "Green" to mean Pb-Free (RoHS compatible), and free of Bromine (Br) and Antimony (Sb) based flame retardants (Br or Sb do not exceed 0.1% by weight in homogeneous material)

(3) MSL, Peak Temp. -- The Moisture Sensitivity Level rating according to the JEDEC industry standard classifications, and peak solder temperature.

(4) There may be additional marking, which relates to the logo, the lot trace code information, or the environmental category on the device.

(5) Multiple Device Markings will be inside parentheses. Only one Device Marking contained in parentheses and separated by a "~" will appear on a device. If a line is indented then it is a continuation of the previous line and the two combined represent the entire Device Marking for that device.

**Important Information and Disclaimer:** The information provided on this page represents TI's knowledge and belief as of the date that it is provided. TI bases its knowledge and belief on information provided by third parties, and makes no representation or warranty as to the accuracy of such information. Efforts are underway to better integrate information from third parties. TI has taken and continues to take reasonable steps to provide representative and accurate information but may not have conducted destructive testing or chemical analysis on incoming materials and chemicals. TI and TI suppliers consider certain information to be proprietary, and thus CAS numbers and other limited information may not be available for release.

In no event shall TI's liability arising out of such information exceed the total purchase price of the TI part(s) at issue in this document sold by TI to Customer on an annual basis.

**TAPE AND REEL INFORMATION**

**QUADRANT ASSIGNMENTS FOR PIN 1 ORIENTATION IN TAPE**

\*All dimensions are nominal

Device	Package Type	Package Drawing	Pins	SPQ	Reel Diameter (mm)	Reel Width W1 (mm)	A0 (mm)	B0 (mm)	K0 (mm)	P1 (mm)	W (mm)	Pin1 Quadrant
LM3311SQ-HIOP/NOPB	WQFN	RTW	24	1000	178.0	12.4	4.3	4.3	1.3	8.0	12.0	Q1
LM3311SQX-HIOP/NOPB	WQFN	RTW	24	4500	330.0	12.4	4.3	4.3	1.3	8.0	12.0	Q1
LM3311SQX/NOPB	WQFN	RTW	24	4500	330.0	12.4	4.3	4.3	1.3	8.0	12.0	Q1

**TAPE AND REEL BOX DIMENSIONS**



\*All dimensions are nominal

Device	Package Type	Package Drawing	Pins	SPQ	Length (mm)	Width (mm)	Height (mm)
LM3311SQ-HIOP/NOPB	WQFN	RTW	24	1000	203.0	190.0	41.0
LM3311SQX-HIOP/NOPB	WQFN	RTW	24	4500	367.0	367.0	35.0
LM3311SQX/NOPB	WQFN	RTW	24	4500	367.0	367.0	35.0

RTW0024A

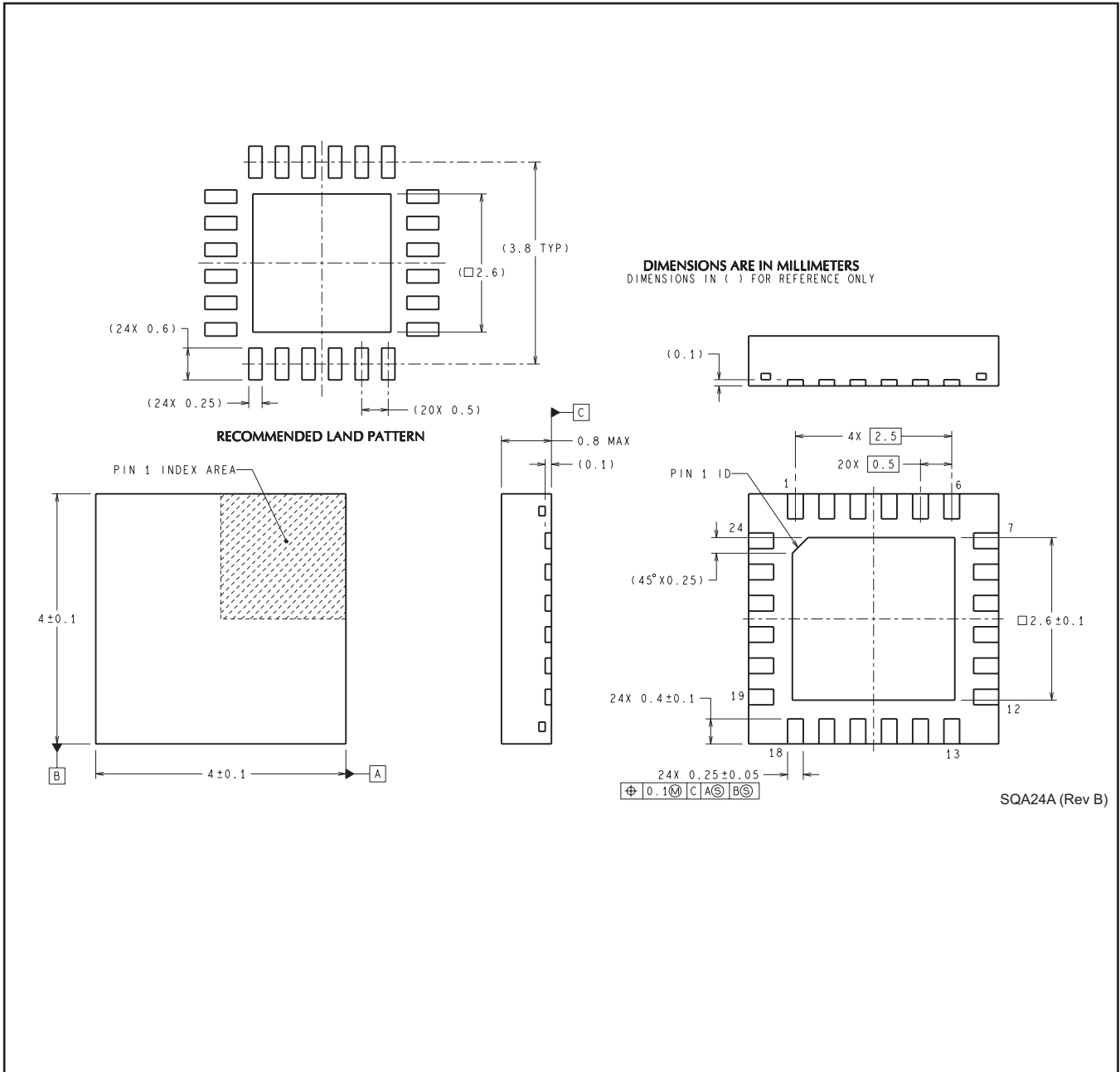

## IMPORTANT NOTICE

Texas Instruments Incorporated and its subsidiaries (TI) reserve the right to make corrections, enhancements, improvements and other changes to its semiconductor products and services per JESD46, latest issue, and to discontinue any product or service per JESD48, latest issue. Buyers should obtain the latest relevant information before placing orders and should verify that such information is current and complete. All semiconductor products (also referred to herein as "components") are sold subject to TI's terms and conditions of sale supplied at the time of order acknowledgment.

TI warrants performance of its components to the specifications applicable at the time of sale, in accordance with the warranty in TI's terms and conditions of sale of semiconductor products. Testing and other quality control techniques are used to the extent TI deems necessary to support this warranty. Except where mandated by applicable law, testing of all parameters of each component is not necessarily performed.

TI assumes no liability for applications assistance or the design of Buyers' products. Buyers are responsible for their products and applications using TI components. To minimize the risks associated with Buyers' products and applications, Buyers should provide adequate design and operating safeguards.

TI does not warrant or represent that any license, either express or implied, is granted under any patent right, copyright, mask work right, or other intellectual property right relating to any combination, machine, or process in which TI components or services are used. Information published by TI regarding third-party products or services does not constitute a license to use such products or services or a warranty or endorsement thereof. Use of such information may require a license from a third party under the patents or other intellectual property of the third party, or a license from TI under the patents or other intellectual property of TI.

Reproduction of significant portions of TI information in TI data books or data sheets is permissible only if reproduction is without alteration and is accompanied by all associated warranties, conditions, limitations, and notices. TI is not responsible or liable for such altered documentation. Information of third parties may be subject to additional restrictions.

Resale of TI components or services with statements different from or beyond the parameters stated by TI for that component or service voids all express and any implied warranties for the associated TI component or service and is an unfair and deceptive business practice. TI is not responsible or liable for any such statements.

Buyer acknowledges and agrees that it is solely responsible for compliance with all legal, regulatory and safety-related requirements concerning its products, and any use of TI components in its applications, notwithstanding any applications-related information or support that may be provided by TI. Buyer represents and agrees that it has all the necessary expertise to create and implement safeguards which anticipate dangerous consequences of failures, monitor failures and their consequences, lessen the likelihood of failures that might cause harm and take appropriate remedial actions. Buyer will fully indemnify TI and its representatives against any damages arising out of the use of any TI components in safety-critical applications.

In some cases, TI components may be promoted specifically to facilitate safety-related applications. With such components, TI's goal is to help enable customers to design and create their own end-product solutions that meet applicable functional safety standards and requirements. Nonetheless, such components are subject to these terms.

No TI components are authorized for use in FDA Class III (or similar life-critical medical equipment) unless authorized officers of the parties have executed a special agreement specifically governing such use.

Only those TI components which TI has specifically designated as military grade or "enhanced plastic" are designed and intended for use in military/aerospace applications or environments. Buyer acknowledges and agrees that any military or aerospace use of TI components which have **not** been so designated is solely at the Buyer's risk, and that Buyer is solely responsible for compliance with all legal and regulatory requirements in connection with such use.

TI has specifically designated certain components as meeting ISO/TS16949 requirements, mainly for automotive use. In any case of use of non-designated products, TI will not be responsible for any failure to meet ISO/TS16949.

### Products

Audio	<a href="http://www.ti.com/audio">www.ti.com/audio</a>
Amplifiers	<a href="http://amplifier.ti.com">amplifier.ti.com</a>
Data Converters	<a href="http://dataconverter.ti.com">dataconverter.ti.com</a>
DLP® Products	<a href="http://www.dlp.com">www.dlp.com</a>
DSP	<a href="http://dsp.ti.com">dsp.ti.com</a>
Clocks and Timers	<a href="http://www.ti.com/clocks">www.ti.com/clocks</a>
Interface	<a href="http://interface.ti.com">interface.ti.com</a>
Logic	<a href="http://logic.ti.com">logic.ti.com</a>
Power Mgmt	<a href="http://power.ti.com">power.ti.com</a>
Microcontrollers	<a href="http://microcontroller.ti.com">microcontroller.ti.com</a>
RFID	<a href="http://www.ti-rfid.com">www.ti-rfid.com</a>
OMAP Applications Processors	<a href="http://www.ti.com/omap">www.ti.com/omap</a>
Wireless Connectivity	<a href="http://www.ti.com/wirelessconnectivity">www.ti.com/wirelessconnectivity</a>

### Applications

Automotive and Transportation	<a href="http://www.ti.com/automotive">www.ti.com/automotive</a>
Communications and Telecom	<a href="http://www.ti.com/communications">www.ti.com/communications</a>
Computers and Peripherals	<a href="http://www.ti.com/computers">www.ti.com/computers</a>
Consumer Electronics	<a href="http://www.ti.com/consumer-apps">www.ti.com/consumer-apps</a>
Energy and Lighting	<a href="http://www.ti.com/energy">www.ti.com/energy</a>
Industrial	<a href="http://www.ti.com/industrial">www.ti.com/industrial</a>
Medical	<a href="http://www.ti.com/medical">www.ti.com/medical</a>
Security	<a href="http://www.ti.com/security">www.ti.com/security</a>
Space, Avionics and Defense	<a href="http://www.ti.com/space-avionics-defense">www.ti.com/space-avionics-defense</a>
Video and Imaging	<a href="http://www.ti.com/video">www.ti.com/video</a>

### TI E2E Community

[e2e.ti.com](http://e2e.ti.com)