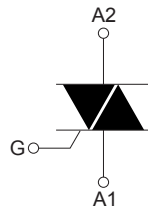


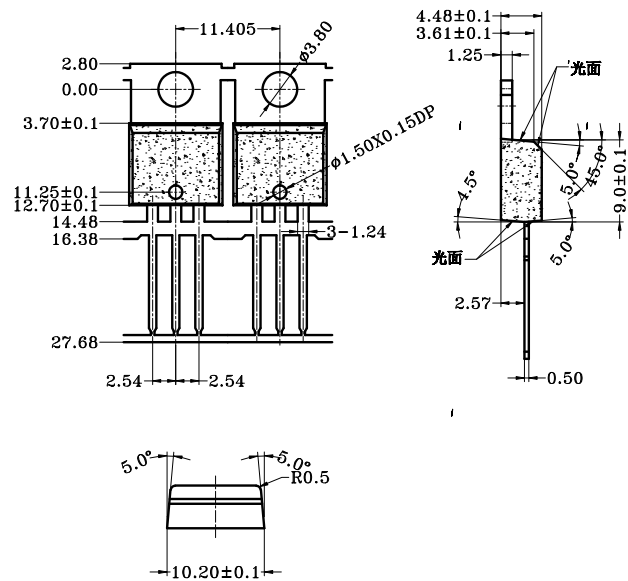
### Features

- Medium current Triac
- Low thermal resistance with clip bonding
- Low thermal resistance insulation ceramic for insulated BTA
- High commutation (4Q) or very high commutation (3Q, Snubberless™) capability

BTA series UL1557 certified (file ref: 81734)  
 Packages are RoHS (2002/95/EC) compliant  
 insulated tab (BTA series, rated at 2500 V<sub>RMS</sub>)



TO-220



## MAXIMUM RATINGS AND ELECTRICAL CHARACTERISTICS

### ELECTRICAL CHARACTERISTICS (T<sub>j</sub> = 25°C, unless otherwise specified)

Symbol	Parameter	Value	Unit
I <sub>T(RMS)</sub>	RMS on-state current (full sine wave)	TO-220AB, D <sup>2</sup> PAK T <sub>c</sub> = 105 °C	12 A
		TO-220AB Ins. T <sub>c</sub> = 90 °C	
I <sub>TSM</sub>	Non repetitive surge peak on-state current (full cycle, T <sub>j</sub> initial = 25 °C)	f = 50 Hz t = 20 ms	120 A
		f = 60 Hz t <sub>p</sub> = 16.7 ms	
i <sup>2</sup> t	i <sup>2</sup> t value for fusing	t <sub>p</sub> = 10 ms	78 A <sup>2</sup> s
di/dt	Critical rate of rise of on-state current I <sub>G</sub> = 2 x I <sub>GT</sub> , tr ≤ 100 ns	f = 120 Hz T <sub>j</sub> = 125 °C	50 A/μs
V <sub>DSM</sub> /V <sub>RSM</sub>	Non repetitive surge peak off-state voltage	t <sub>p</sub> = 10 ms T <sub>j</sub> = 25 °C	V <sub>DRM</sub> / V <sub>RRM</sub> + 100 V
I <sub>GM</sub>	Peak gate current	t <sub>p</sub> = 20 μs T <sub>j</sub> = 125 °C	4 A
P <sub>G(AV)</sub>	Average gate power dissipation	T <sub>j</sub> = 125 °C	1 W
T <sub>stg</sub>	Storage junction temperature range		-40 to +150 °C
T <sub>j</sub>	Operating junction temperature range		-40 to +125 °C

# BTA12, BTB12, T1205 T1210, T1235, T1250

## Electrical characteristics ( $T_j = 25\text{ }^\circ\text{C}$ , unless otherwise specified) - standard (4 quadrants)

Symbol	Parameter	Quadrant		Value		Unit
				C	B	
$I_{GT}^{(1)}$	$V_D = 12\text{ V}, R_L = 30\ \Omega$	I - II - III	Max.	25	50	mA
		IV		50	100	
$V_{GT}$		All	Max.	1.3		V
$V_{GD}$	$V_D = V_{DRM}, R_L = 33\text{ k}\Omega, T_j = 125\text{ }^\circ\text{C}$	All	Min.	0.2		V
$I_H^{(2)}$	$I_T = 500\text{ mA}$	I - II - III	Max.	25	50	mA
$I_L$	$I_G = 1.2\ I_{GT}$	I - III - IV	Max.	40	50	mA
		II		80	100	
$dV/dt^{(2)}$	$V_D = 67\% V_{DRM}$ gate open, $T_j = 125\text{ }^\circ\text{C}$		Min.	200	400	V/ $\mu\text{s}$
$(dV/dt)_C^{(2)}$	$(dI/dt)_C = 5.3\text{ A/ms}, T_j = 125\text{ }^\circ\text{C}$		Min.	5	10	V/ $\mu\text{s}$

1. Minimum  $I_{GT}$  is guaranteed at 5 % of  $I_{GT}$  max.
2. For both polarities of A2 referenced to A1

## Electrical characteristics ( $T_j = 25\text{ }^\circ\text{C}$ , unless otherwise specified) - Snubberless and logic level (3 quadrants)

Symbol	Parameter	Quadrant		T1205	T1210	T1235	T1250	Unit
				BTB12-TW BTA12-TW	BTB12-SW BTA12-SW	BTB12-CW BTA12-CW	BTB12-BW BTA12-BW	
$I_{GT}^{(1)}$	$V_D = 12\text{ V}, R_L = 30\ \Omega$	I - II - III	Max.	5	10	35	50	mA
			Max.	1.3				
$V_{GT}$		I - II - III	Max.	1.3				V
$V_{GD}$	$V_D = V_{DRM}, R_L = 3.3\text{ k}\Omega, T_j = 125\text{ }^\circ\text{C}$	I - II - III	Min.	0.2				V
$I_H^{(2)}$	$I_T = 100\text{ mA}$	I - II - III	Max.	10	15	35	50	mA
$I_L^{(2)}$	$I_G = 1.2 \times I_{GT}$	I - III	Max.	10	25	50	70	mA
		II	Max.	15	30	60	80	
$dV/dt^{(2)}$	$V_D = 67\% V_{DRM}$ , gate open, $T_j = 125\text{ }^\circ\text{C}$		Max.	20	40	500	1000	V/ $\mu\text{s}$
$(dI/dt)_C^{(2)}$	$(dV/dt)_C = 0.1\text{ V}/\mu\text{s}, T_j = 125\text{ }^\circ\text{C}$		Min.	3.5	6.5			A/ms
	$(dV/dt)_C = 10\text{ V}/\mu\text{s}, T_j = 125\text{ }^\circ\text{C}$		Min.	1.0	2.9			
	Without snubber, $T_j = 125\text{ }^\circ\text{C}$		Min.			6.5	12	

1. Minimum  $I_{GT}$  is guaranteed at 5 % of  $I_{GT}$  max.
2. For both polarities of A2 referenced to A1

# BTA12, BTB12, T1205 T1210, T1235, T1250

## Static electrical characteristics

Symbol	Test conditions			Value	Unit
$V_{TM}^{(1)}$	$I_{TM} = 17\text{ A}$ , $t_p = 380\ \mu\text{s}$	$T_j = 25\ ^\circ\text{C}$	Max.	1.55	V
$V_{TO}^{(1)}$	threshold on-state voltage	$T_j = 125\ ^\circ\text{C}$	Max.	0.85	V
$R_D^{(1)}$	Dynamic resistance	$T_j = 125\ ^\circ\text{C}$	Max.	35	m $\Omega$
$I_{DRM}$ $I_{RRM}$	$V_{DRM} = V_{RRM}$	$T_j = 25\ ^\circ\text{C}$	Max.	5	$\mu\text{A}$
		$T_j = 125\ ^\circ\text{C}$	Max.	1	mA

1. For both polarities of A2 referenced to A1

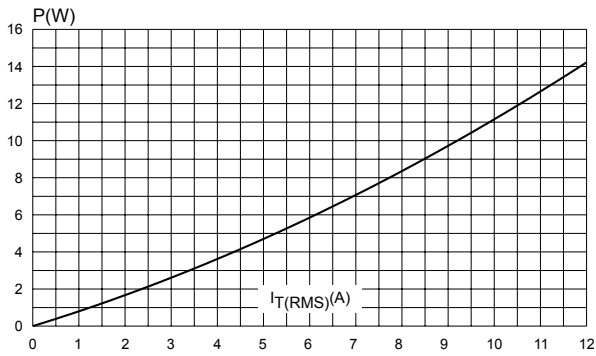
## Thermal resistance

Symbol	Parameter			Value	Unit	
$R_{th(j-c)}$	Max. junction to case thermal resistance (AC)		D <sup>2</sup> PAK / TO-220AB	Max.	1.4	$^\circ\text{C/W}$
			TO-220AB insulated	Max.	2.3	
$R_{th(j-a)}$	Junction to ambient	$S = 2\ \text{cm}^2$ <sup>(1)</sup>	D <sup>2</sup> PAK	Typ.	45	$^\circ\text{C/W}$
	Junction to ambient		TO-220AB / TO-220AB insulated	Typ.	60	

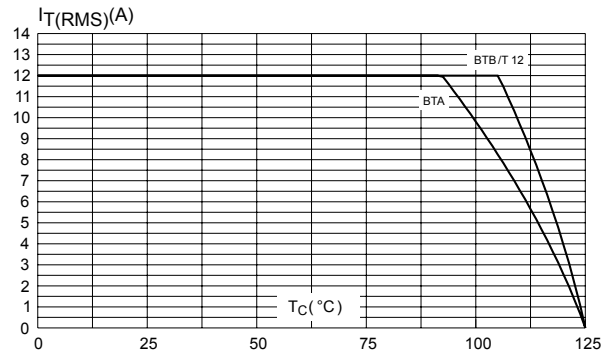
1.  $S$  = Copper surface under tab.

## RATING AND CHARACTERISTIC CURVES (BTA12,BTB12,T1205,T1210,T1235,T1250)

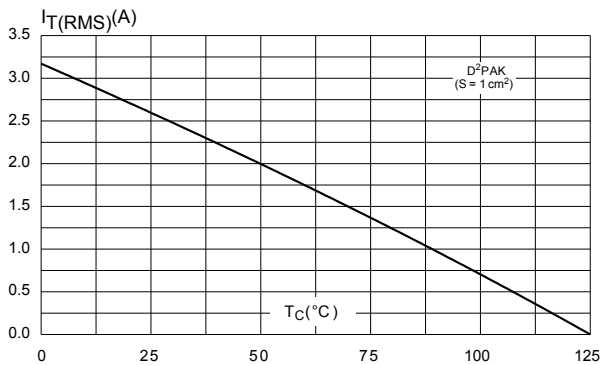
**Figure 1. Maximum power dissipation versus on-state RMS current (full cycle)**



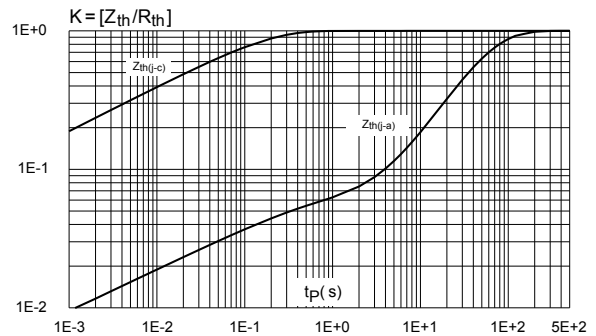
**Figure 2. RMS on-state current versus case temperature (full cycle)**



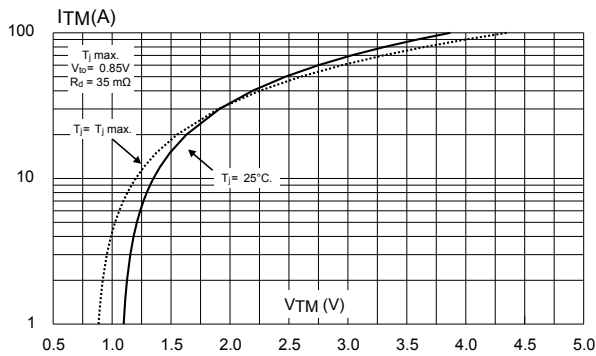
**Figure 3. RMS on-state current versus ambient temperature (printed circuit board FR4, copper thickness: 35 μm) (full cycle)**



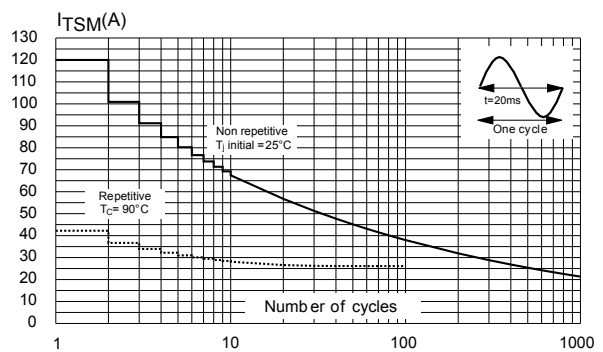
**Figure 4. Relative variation of thermal impedance versus pulse duration**



**Figure 5. On-state characteristics (maximum values)**

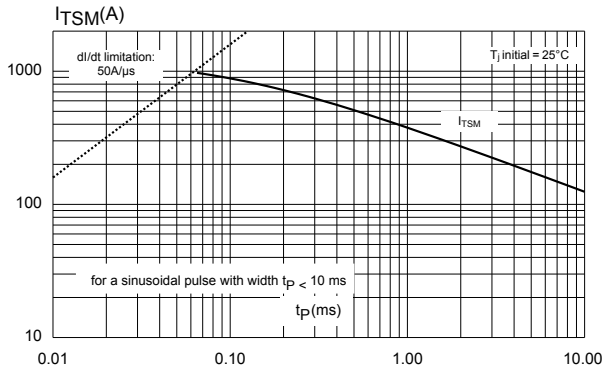


**Figure 6. Surge peak on-state current versus number of cycles**

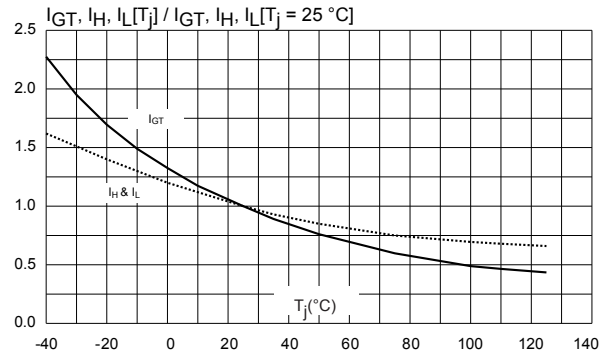


## RATING AND CHARACTERISTIC CURVES (BTA12,BTB12,T1205,T1210,T1235,T1250)

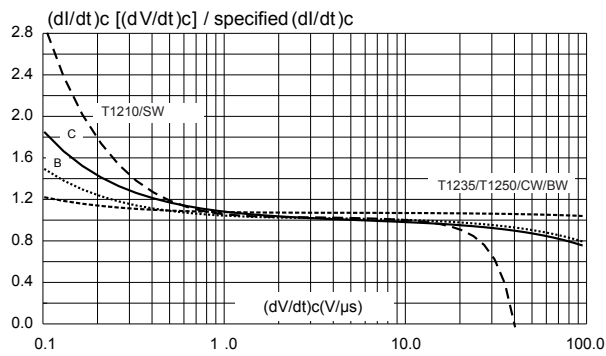
**Figure 7. Non repetitive surge peak on-state current for a sinusoidal pulse**



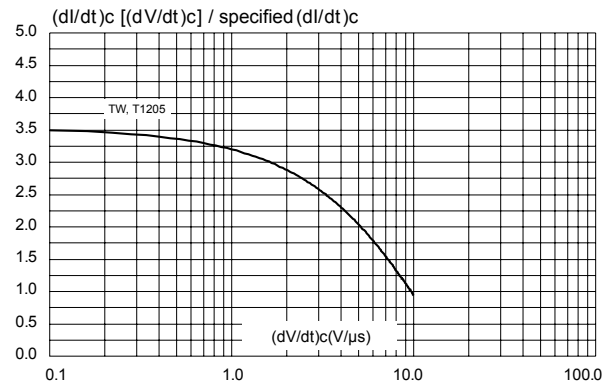
**Figure 8. Relative variation of gate trigger current holding current and latching current versus junction temperature (typical values)**



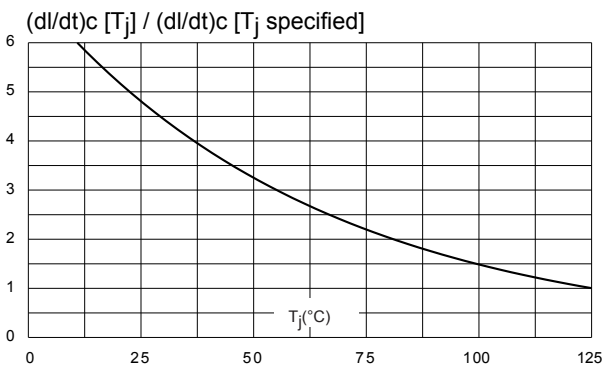
**Figure 9. Relative variation of critical rate of decrease of main current versus (dV/dt)c (typical values)**



**Figure 10. Relative variation of critical rate of decrease of main current versus (dV/dt)c (typical values)(TW)**



**Figure 11. Relative variation of critical rate of decrease of main current versus junction temperature**



**Figure 12. D<sup>2</sup>PAK thermal resistance junction to ambient versus copper surface under tab**

