

78L12

Three-terminal positive voltage regulator

Features:

- Maximum Output current I_o : 0.1A
- Output voltage V_o : 12V
- Continuous total dissipation
 P_D : 0.6W ($T_a = 25^\circ\text{C}$)

Marking: 78L12

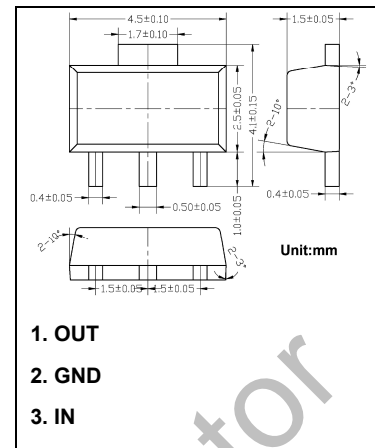

Absolute Maximum Ratings (Operating temperature range applies unless otherwise specified)

Symbol	Parameter	Value	Unit
V_i	Input Voltage	30	V
T_{OPR}	Operating Junction Temperature Range	-25 to +150	$^\circ\text{C}$
T_{STG}	Storage Temperature Range	-55 to +150	$^\circ\text{C}$

Electrical Characteristics at Specified Virtual Junction Temperature

($V_i=19\text{V}$, $I_o=40\text{mA}$, $C_i=0.33\mu\text{F}$, $C_o=0.1\mu\text{F}$, unless otherwise specified)

Symbol	Parameter	Test conditions	Min	Typ	Max	Unit	
V_o	Output Voltage	25°C	11.5	12	12.5	V	
		$14\text{V} \leq V_i \leq 27\text{V}$, $I_o=1\text{mA}-40\text{mA}$	$0-125^\circ\text{C}$	11.4	12	12.6	V
				11.4	12	12.6	V
ΔV_o	Load Regulation	$I_o=1\text{mA}-100\text{mA}$, 25°C		22	100	mV	
		$I_o=1\text{mA}-40\text{mA}$, 25°C		13	50	mV	
ΔV_o	Line Regulation	$14\text{V} \leq V_i \leq 27\text{V}$, 25°C		55	250	mV	
		$16\text{V} \leq V_i \leq 27\text{V}$, 25°C		49	200	mV	
I_q	Quiescent Current	25°C		4.3	6.5	mA	
ΔI_q	Quiescent Current Change	$16\text{V} \leq V_i \leq 27\text{V}$, $0-125^\circ\text{C}$			1.5	mA	
		$1\text{mA} \leq I_o \leq 40\text{mA}$, $0-125^\circ\text{C}$			0.1	mA	
V_N	Output Noise Voltage	$f=10\text{Hz to }100\text{KHz}$, 25°C		70		μV	
RR	Ripple Rejection	$f=120\text{Hz}$, $15\text{V} \leq V_i \leq 25\text{V}$, $0-125^\circ\text{C}$	37	42		dB	
V_d	Dropout Voltage	25°C		1.7		V	

Typical Application

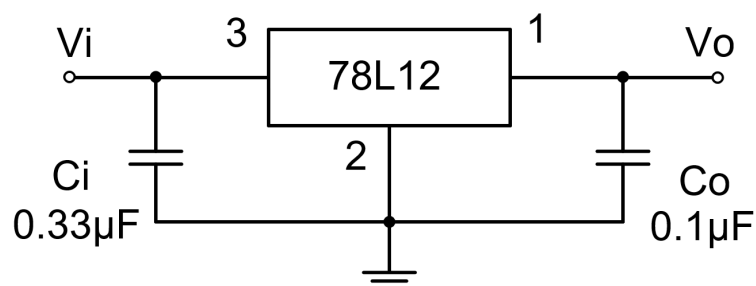

Note: Bypass capacitors are recommended for optimum stability and transient response and should be located as close as Possible to the regulators.

Typical Characteristics

Output Characteristics

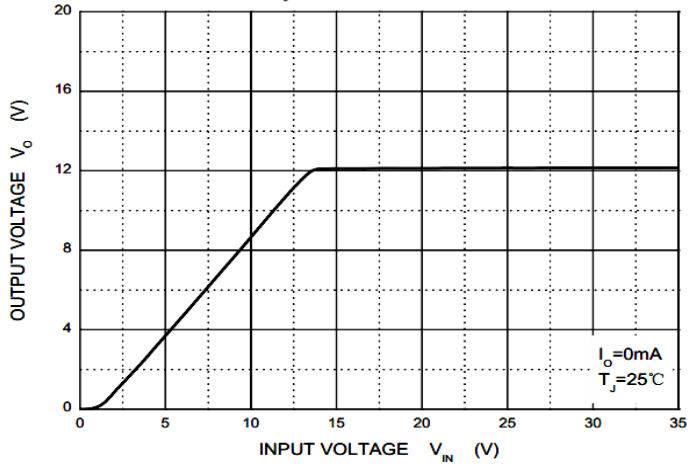

Dropout Characteristics

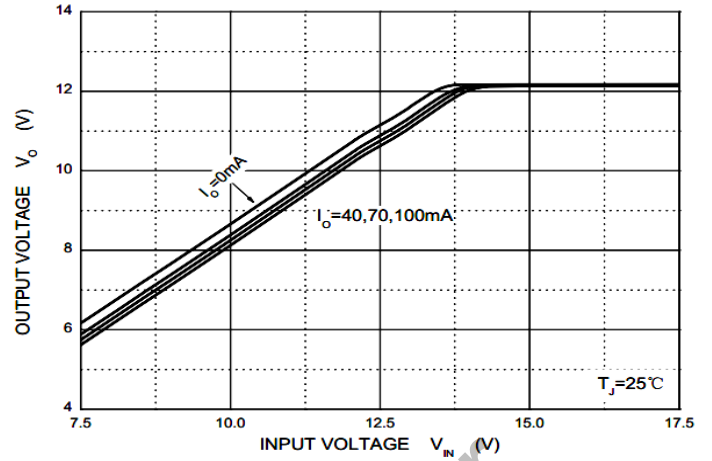

Quiescent Current

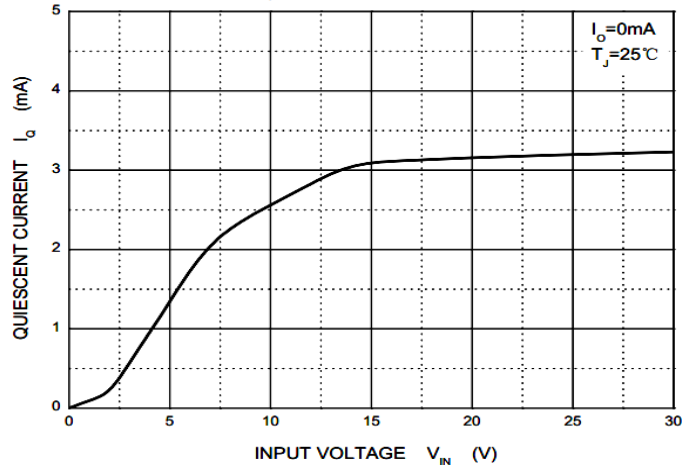

Quiescent Current vs Output Current

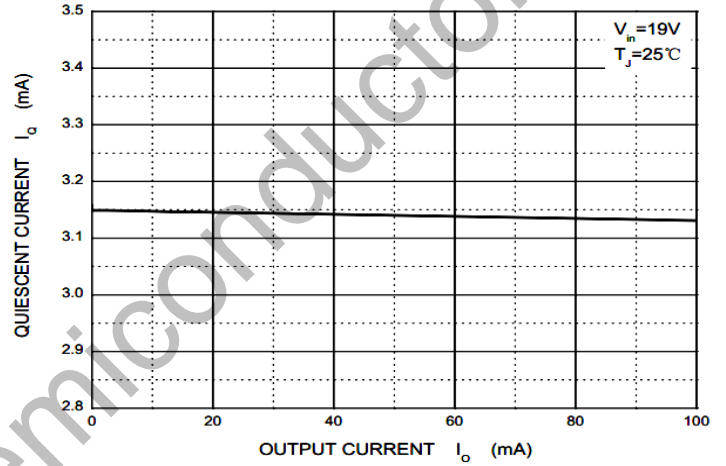

Output Voltage vs Ambient Temperature

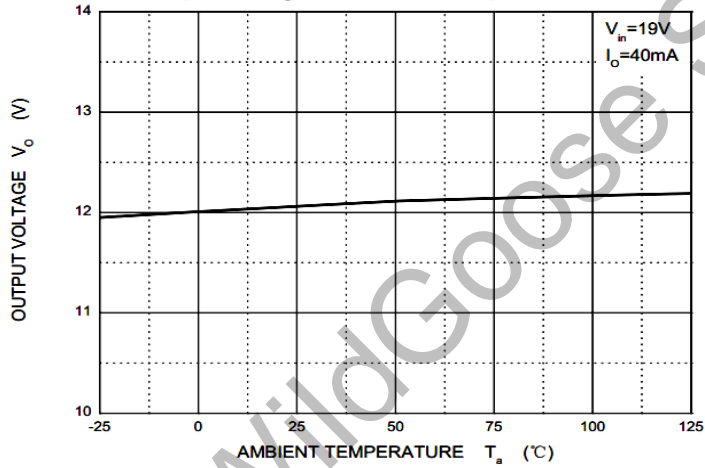

Current Cut-off Grid Voltage

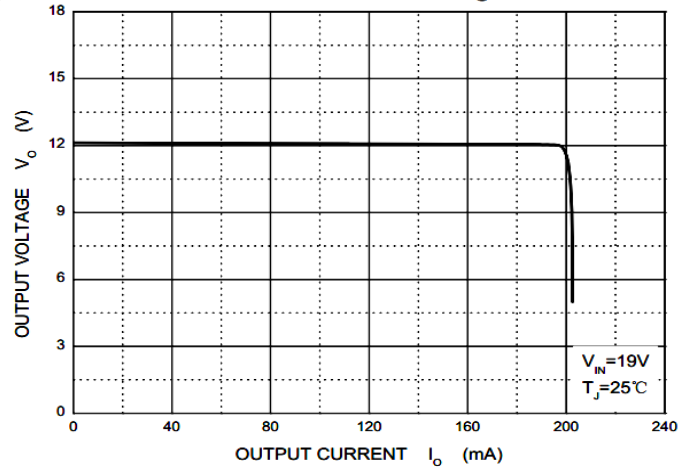

Power Derating Curve

