

■ Features

- High isolation 3750 VRMS
- AC input with transistor output
- Operating temperature range - 55 °C to 100 °C
- RoHS & REACH Compliance
- Halogen free
- MSL class 1

■ Applications

- Switch mode power supplies
- Programmable controllers
- Household appliances
- Office equipment

■ Description

The MP3H4 series combine two AlGaAs infrared emitting diode as the emitter which is optically coupled to a silicon planar Phototransistor detector in a plastic SSOP4 Package. With the robust coplanar double mold structure, MP3H4 series provide the most stable isolation feature.

■ Schematic

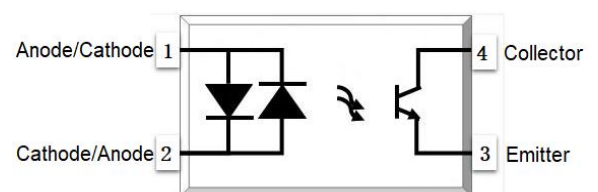



MP3H4 Series
SSOP4, AC Input, Photo Transistor Coupler

ABSOLUTE MAXIMUM RATINGS				
PARAMETER	SYMBOL	VALUE	UNIT	NOTE
INPUT				
Forward Current	I_F	±60	mA	
Peak Forward Current	I_{FP}	±1	A	1
Input Power Dissipation	P_i	100	mW	
OUTPUT				
Collector - Emitter Voltage	V_{CEO}	80	V	
Emitter - Collector Voltage	V_{ECO}	6	V	
Collector Current	I_c	50	mA	
Output Power Dissipation	P_o	150	mW	
COMMON				
Total Power Dissipation	P_{tot}	200	mW	
Isolation Voltage	V_{iso}	3750	V _{rms}	2
Operating Temperature	T_{opr}	-55~110	°C	
Storage Temperature	T_{stg}	-55~125	°C	
Soldering Temperature	T_{sol}	260	°C	

Note 1. AC For 1 Minute, R.H. = 40 ~ 60%

Note 2. For 10 seconds



MP3H4 Series
SSOP4, AC Input, Photo Transistor Coupler

ELECTRICAL OPTICAL CHARACTERISTICS at Ta=25°C							
PARAMETER	SYMBOL	MIN	TYP.	MAX.	UNIT	TEST CONDITION	NOTE
INPUT							
Forward Voltage	V _F	-	-	1.4	V	IF=10mA	
Input Capacitance	C _{in}	-	10	-	pF	V=0, f=1kHz	
OUTPUT							
Collector Dark Current	I _{CEO}	-	-	100	nA	VCE=20V, IF=0	
Collector-Emitter Breakdown Voltage	BV _{CEO}	80	-	-	V	IC=0.1mA, IF=0	
Emitter-Collector Breakdown Voltage	BV _{ECO}	6	-	-	V	IE=0.1mA, IF=0	
TRANSFER CHARACTERISTICS							
Current Transfer Ratio	MP3H4	20	-	400	%	IF=1mA, VCE=5V	
	MP3H4A	50	-	150			
	MP3H4B	80	-	400			
CTR Symmetry		0.7	-	1.3		IF=±1mA, VCE=5V	
Collector-Emitter Saturation Voltage	V _{CE(sat)}	-	0.07	0.2	V	IF=20mA, IC=1mA	
Isolation Resistance	R _{ISO}	10 ¹²	10 ¹⁴	-	Ω	DC500V, 40 ~ 60% R.H.	
Floating Capacitance	C _{IO}	-	0.4	1	pF	V=0, f=1MHz	
Response Time (Rise)	t _r	-	-	18	μs	VCE=2V, IC=2mA	3
Response Time (Fall)	t _f	-	-	18	μs	RL=100Ω	3

Note 3. Fig.12&13

Note 4. Fig.14

CHARACTERISTIC CURVES

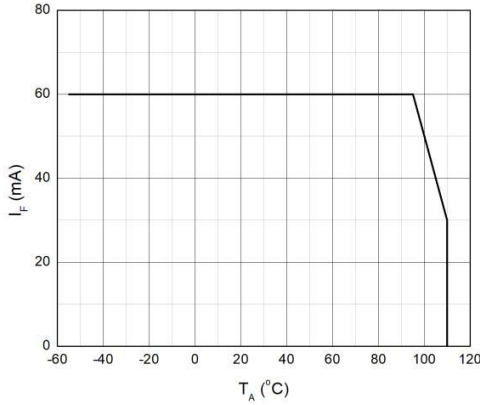

Fig.1 Forward Current vs. Ambient Temperature

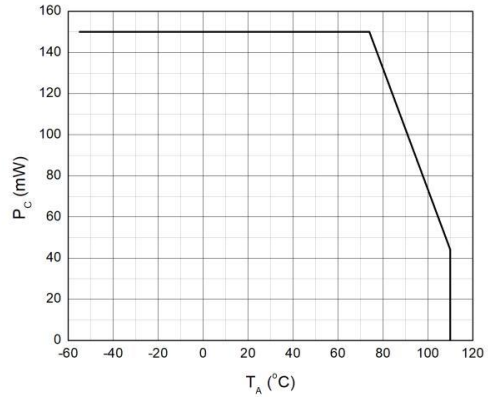

Fig.2 On-state Terminal Current vs. Ambient Temperature

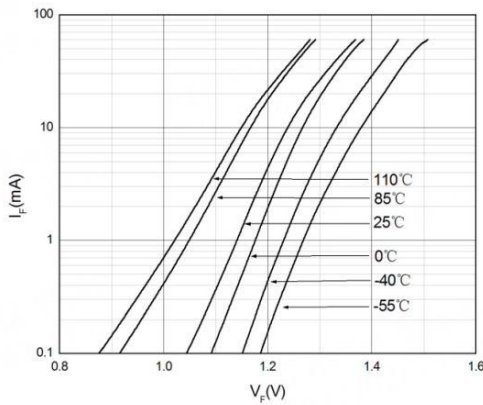

Fig.3 Forward Current vs. Forward Voltage

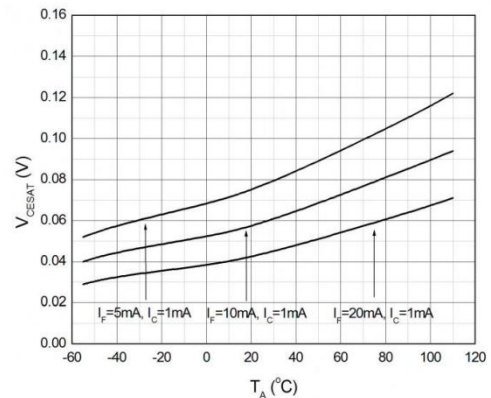

Fig.4 Off-state Terminal Current vs. Ambient Temperature

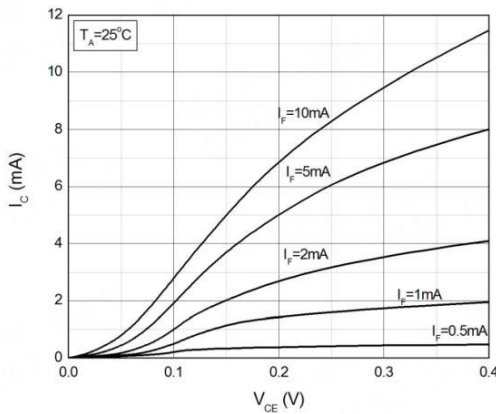

Fig.5 Collector Current vs. Collector-emitter Voltage

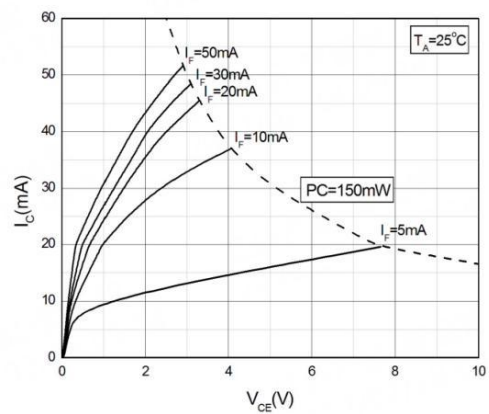

Fig.6 Collector Current vs. Collector-emitter Voltage

CHARACTERISTIC CURVES

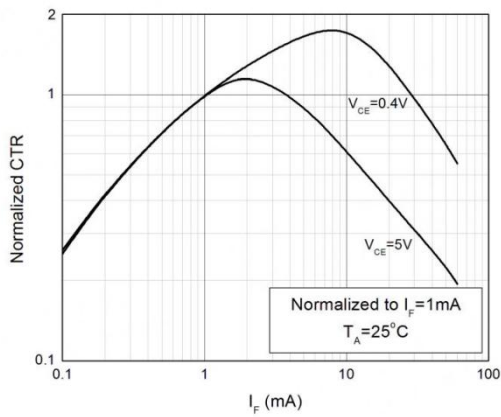

Fig.7 Collector Dark Current vs. Ambient

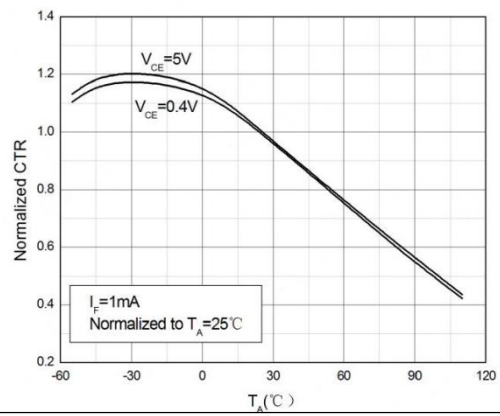

Fig.8 Switching Time vs. Load Resistance

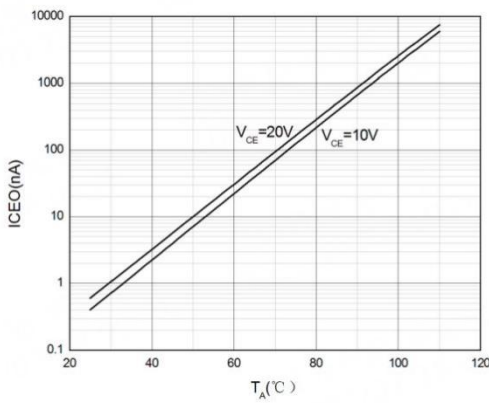

Fig.9 On-state Terminal Voltage vs. On-state Terminal Current

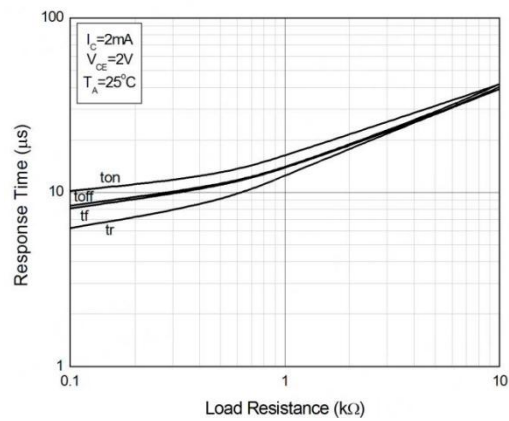

Fig.10 Holding Current vs. Ambient Temperature

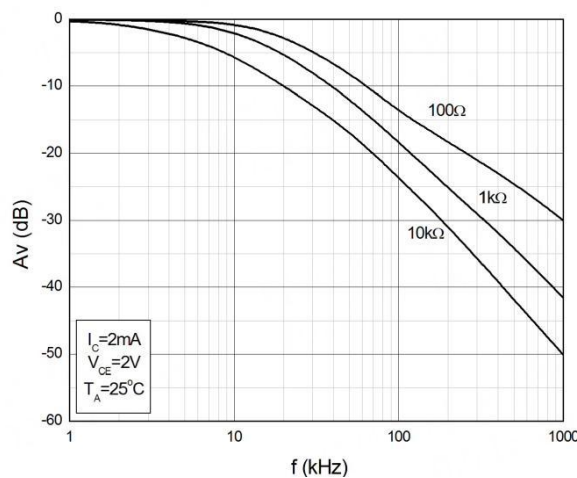

Fig.11 Frequency Respons

TEST CIRCUITS

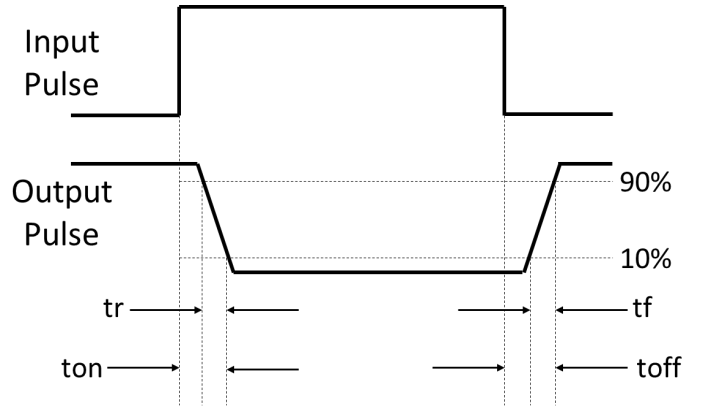
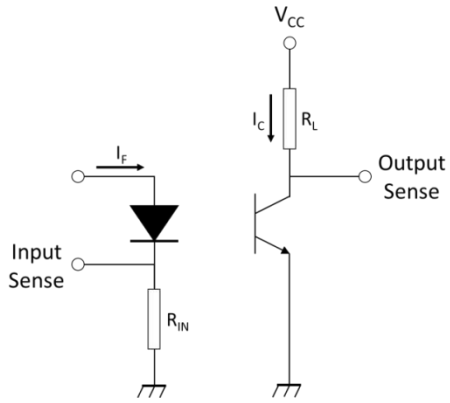

Fig.12 Test Circuits of Response Time

Fig.13 Curves of Response Time

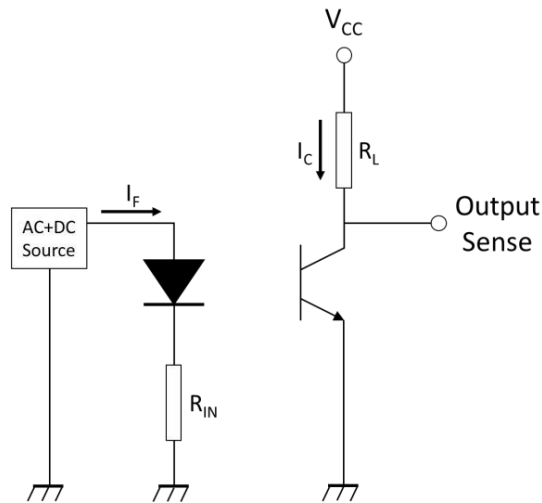
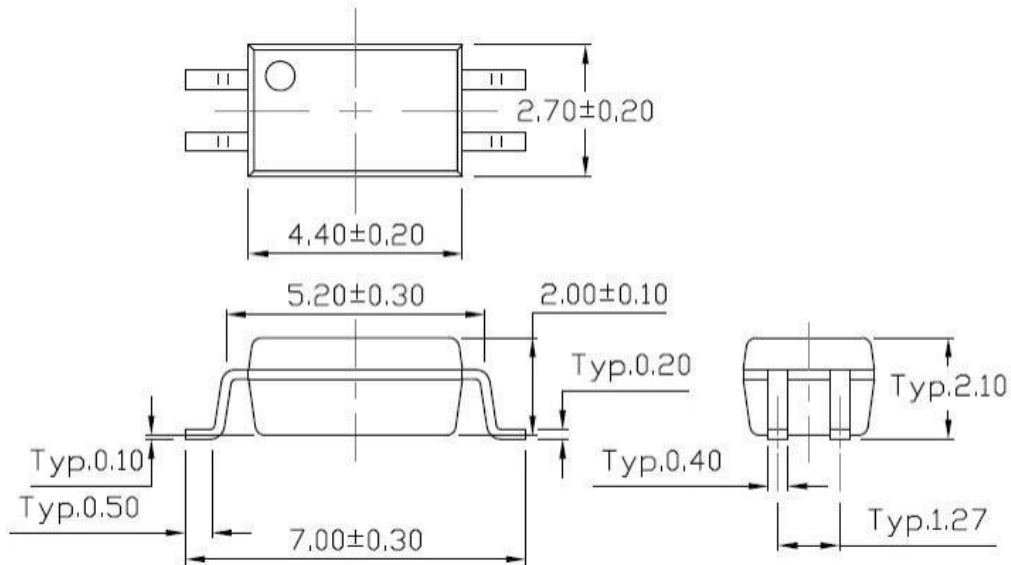
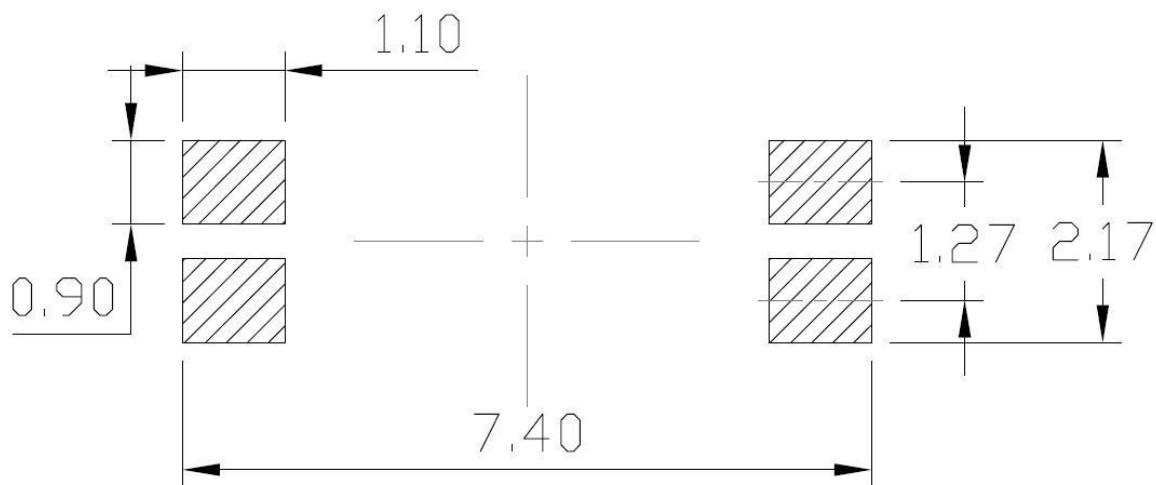

Fig.14 Test Circuits of Frequency Response

PACKAGE DIMENSIONS (Dimensions in mm unless otherwise stated)



Recommended Solder Mask (Dimensions in mm unless otherwise stated)



CARRIER TAPE SPECIFICATIONS (Dimensions in mm unless otherwise stated)

Option T1

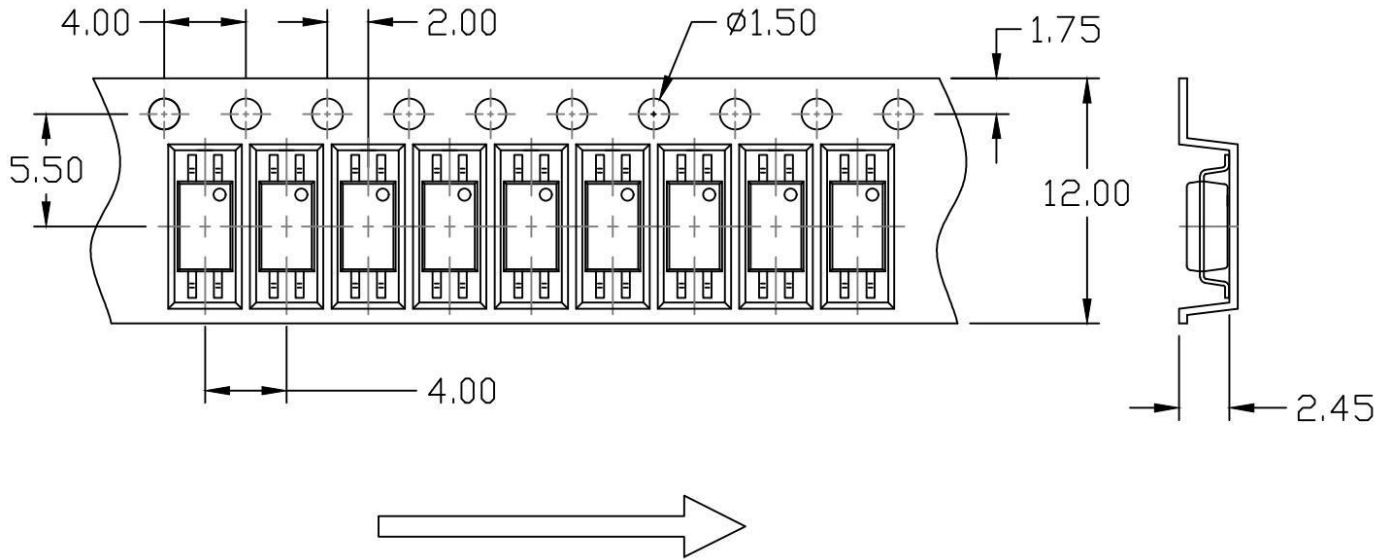

Option T2

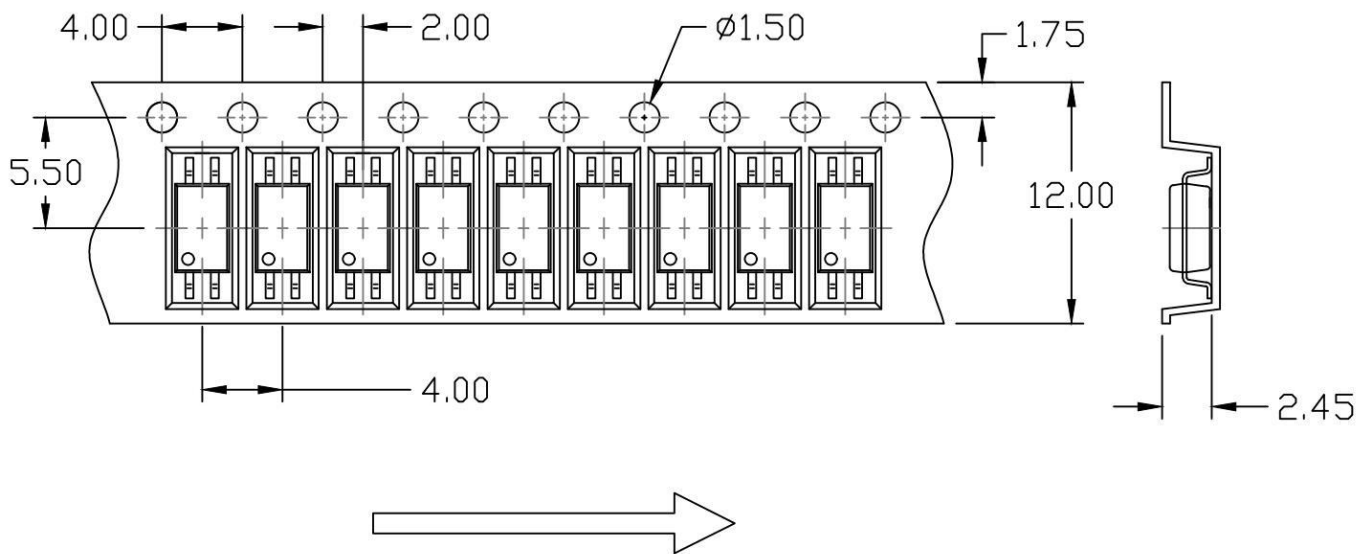

ORDERING AND MARKING INFORMATION

MARKING INFORMATION

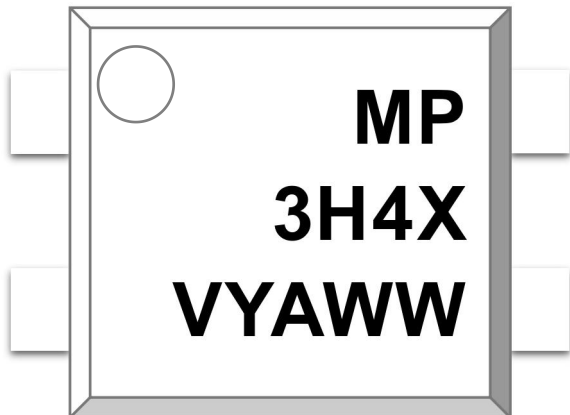

MP :Company Abbr.
3H4 :Part Number
X :CTR Rank
V :VDE Option
Y :Fiscal Year
A :Manufacturing Code
WW :Work Week

ORDERING INFORMATION

MP3H4X(Z)-GV

MP – Company Abbr.
 3H4 – Part Number
 X – CTR Rank (A/B or None)
 Z – Tape and Reel Option (T1/T2)
 G – Material Option (G: Green, None: Non-Green)
 V – VDE Option (V or None)

PACKING QUANTITY

Option	Quantity	Quantity – Inner box	Quantity – Outer box
T1	3000 Units/Reel	3 Reels/Inner box	5 Inner box/Outer box = 45k Units
T2	3000 Units/Reel	3 Reels/Inner box	5 Inner box/Outer box = 45k Units

REFLOW INFORMATION

REFLOW PROFILE

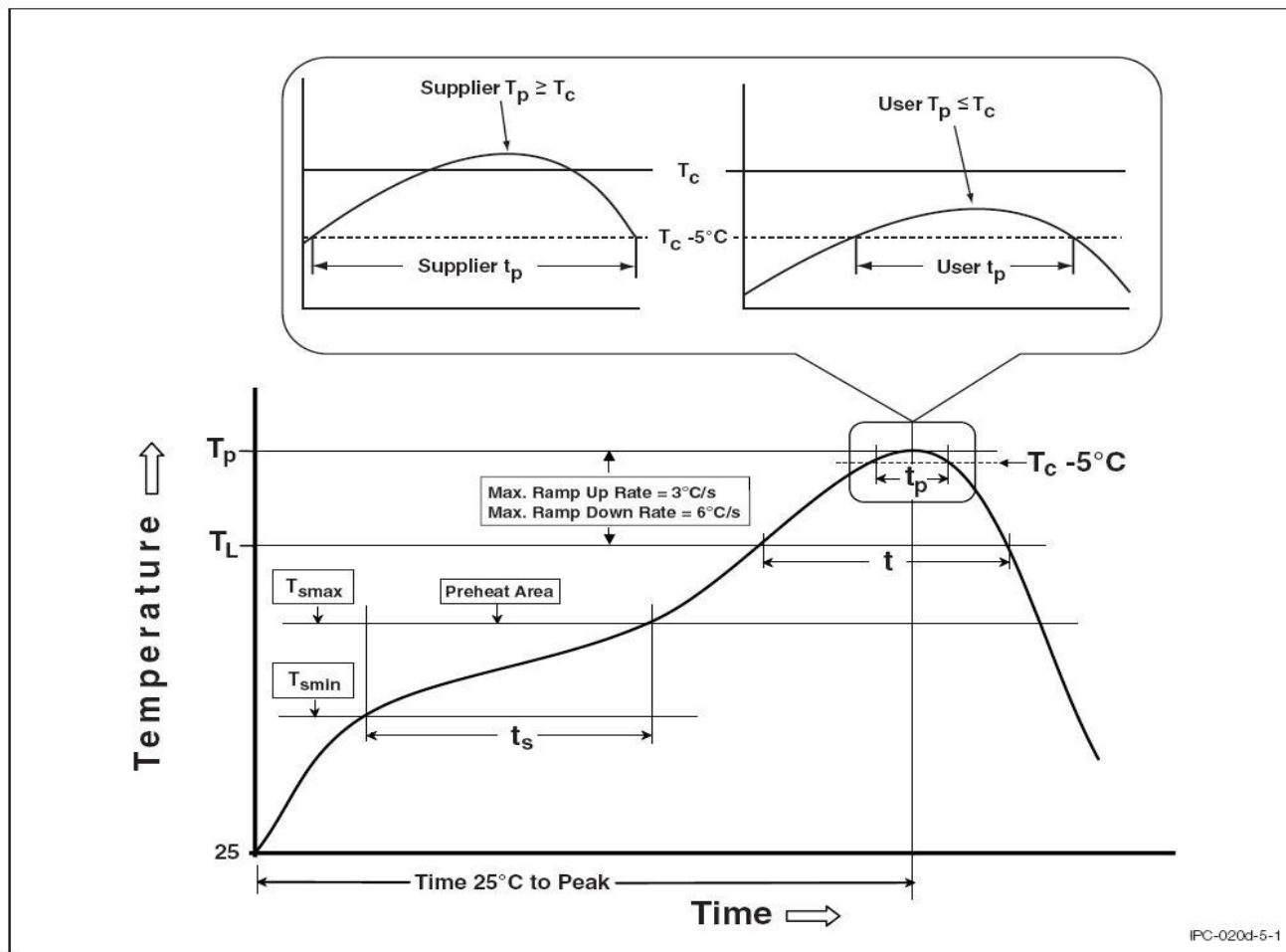

Profile Feature	Sn-Pb Assembly Profile	Pb-Free Assembly Profile
Temperature Min. (TsmIn)	100	150°C
Temperature Max. (Tsmax)	150	200°C
Time (ts) from (TsmIn to Tsmax)	60-120 seconds	60-120 seconds
Ramp-up Rate (tL to tP)	3°C/second max.	3°C/second max.
Liquidous Temperature (TL)	183°C	217°C
Time (tL) Maintained Above (TL)	60 – 150 seconds	60 – 150 seconds
Peak Body Package Temperature	235°C +0°C / -5°C	260°C +0°C / -5°C
Time (tP) within 5°C of 260°C	20 seconds	30 seconds
Ramp-down Rate (TP to TL)	6°C/second max	6°C/second max
Time 25°C to Peak Temperature	6 minutes max.	8 minutes max.



DISCLAIMER

- Our company is continually improving the quality, reliability, function and design. Our company reserves the right to make changes without further notices.
- The characteristic curves shown in this datasheet are representing typical performance which are not guaranteed.
- This product is not intended to be used for military, aircraft, automotive, medical, life sustaining or lifesaving applications or any other application which can result in human injury or death.
- Immerge unit's body in solder paste is not recommended.
- Discoloration might be occurred on the package surface after soldering, reflow or long-time use. It neither impacts the performance nor reliability.

■ **Revision History**

Version	Date	Subjects (major changes since last revision)
0.1	2023-07-05	Datasheet Complete
0.2	2023-08-09	Datasheet Upgrade