

2 3 4 5 6 7 8

NOTES:

1. MATERIALS:

HOUSING: LCP, UL 94V-0.
 CONTACT: BRASS C2680.
 LATCH: STAINLESS STEEL SUS301.

2. FINISH:

1) CONTACT: UNDERPLATED NICKEL 50~150u",
 PLATING ON SOLDER AREA: SEE TABLE
 GOLD PLATING ON CONTACT AREA: SEE TABLE
 2) LATCH: UNDERPLATED NICKEL 50~150u", MATTE TIN 80u" MIN.
 3. ELECTRICAL PERFORMANCE

TABLE:

NO.	PART NO.	COLOR	DESCRIPTION
1	ADDR0110-P001A	BLACK	GOLD G/F ON CONTACT AREA MATTE TIN ON SOLDER AREA

LCR INITIAL 50mΩ MAX PER CONTACT.
 FINAL ALLCR=20mΩ MAX

4. MECHANICAL PERFORMANCE,
 MATING & UNMATING FORCE: 6.1 Kgf MAX.

5. I.R REFLOW:

THE PEAK TEMPERATURE ON THE BOARD SHALL BE
 MAINTAINED FOR 10 SECONDS AT 260±5°C.

6. DC: XXXXXX

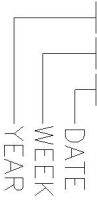

7. ROHS COMPLIANT.
 HF COMPLIANT.

GENERAL TOLERANCES UNLESS SPECIFIED		PART NO.		深圳市连欣科技有限公司	
X ± 0.35	X ° ± 3°	ADDR0110-P001A		TITLE	
XX ± 0.25	X ° ± 2°	APPROVED BY		SODDR4 9.2H 260 PIN STD TYPE	
.XXX ± 0.15	.XX ° ± 1°	Barney		DWG NO.	
CUSTOMER DRAWING		CHECKED BY		AP-ADDR0110	
Vilo		DRAWN BY		XU	
SIZE	UNITS	DRAWN BY			
A4	MM [INCH]	XU			

2 3 4 5 6 7 8

A B C D E F A B C D E F

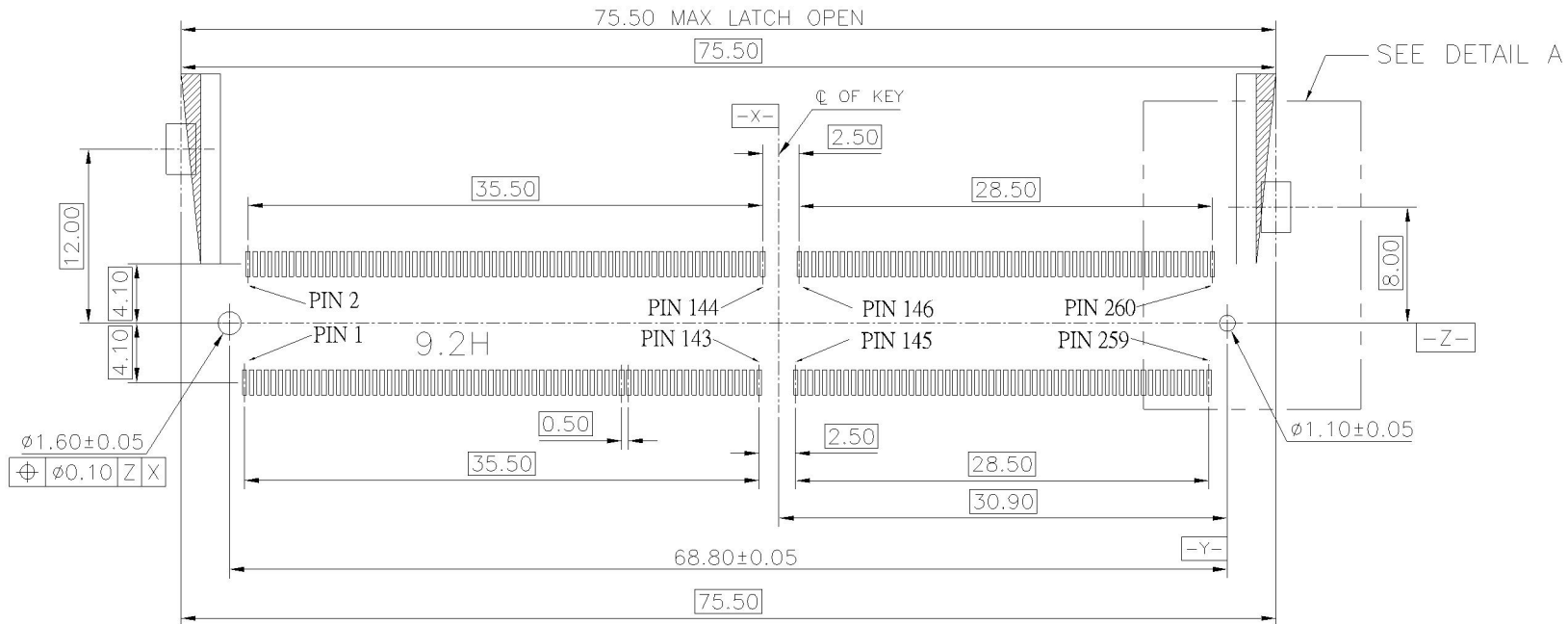

SCALE 2:1

TOP VIEW
RECOMMEND PCB LAYOUT (STANDARD)
THE TOLERANCES UNLESS SPECIFIED IS $\pm 0.05\text{MM}$

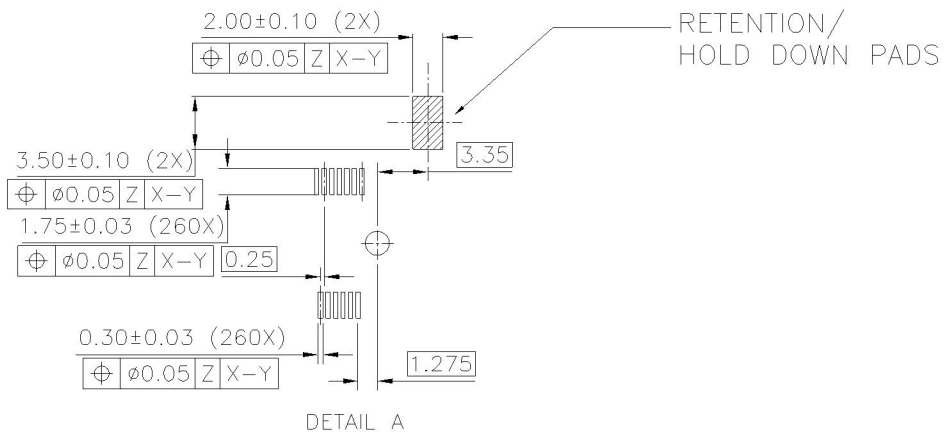

GENERAL TOLERANCES UNLESS SPECIFIED		PART NO.		深圳市连欣科技有限公司	
$X \pm 0.35$	$X^\circ \pm 3^\circ$	ADDR0110-P001A		TITLE	
$.XX \pm 0.25$	$X^\circ \pm 2^\circ$	APPROVED BY		SODDR4 9.2H 260 PIN STD TYPE	
$.XXX \pm 0.15$	$.XX^\circ \pm 1^\circ$	Barney		DWG NO.	
CUSTOMER DRAWING		CHECKED BY		AP-ADDR0110	
		Vito			
SIZE	UNITS	DRAWN BY			
A4	MM[INCH]	XU			
					
				SHEET	SCALE
				3 / 5	1 : 1
				REV	
				K	

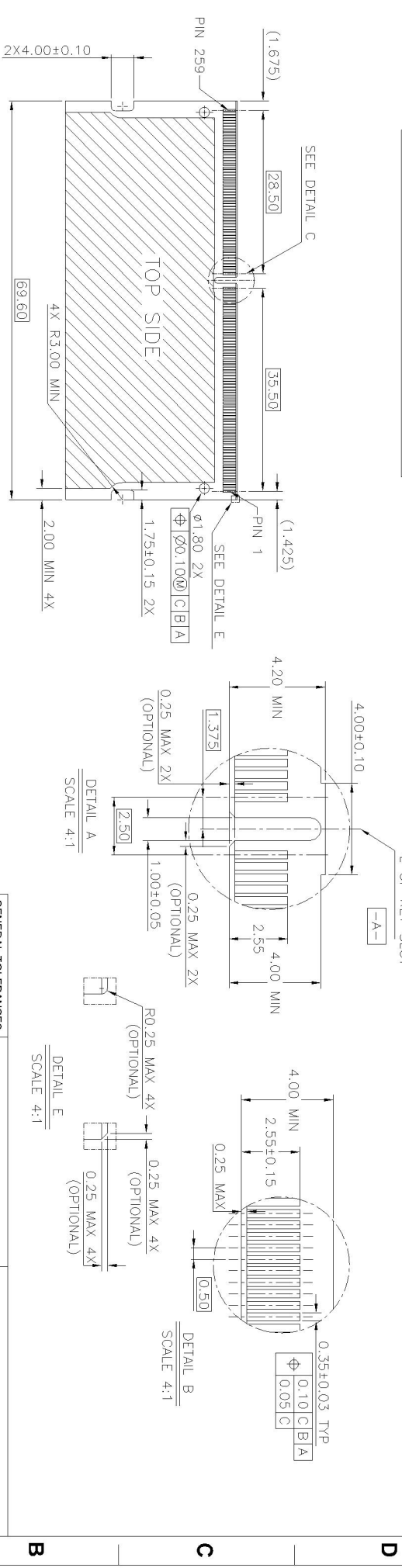
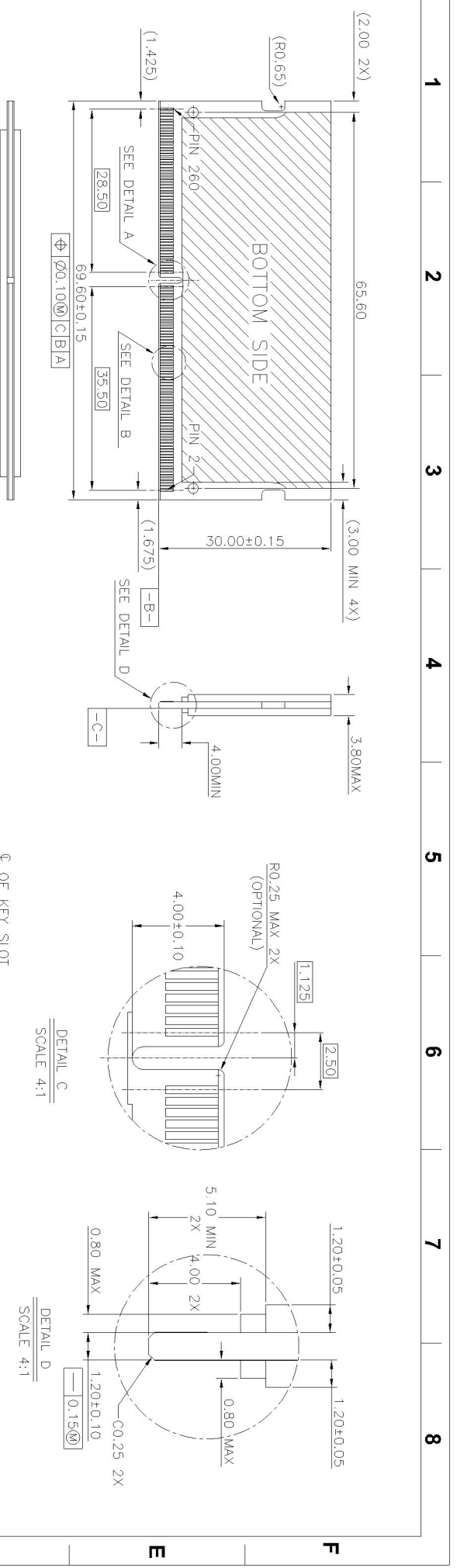

- NOTES:
1. TOLERANCE ON ALL DIMENSIONS ± 0.15 UNLESS OTHERWISE SPECIFIED;
 2. PCB THICKNESS APPLIES ACROSS TABS AND INCLUDES PLATING AND/OR METALIZATION;
 3. FINISH OF PAD: Au PLATING 30u" min OVER Ni PLATING 80u" min;
 4. NO BURR;
 5. CHAMFER 0.25mm max. X 45° IF EXIST.

GENERAL TOLERANCES UNLESS SPECIFIED		PART NO.		深圳市连欣科技有限公司	
X ± 0.35	X° ± 3°	ADDR0110-P001A			
.XX ± 0.25	.X° ± 2°	APPROVED BY		Barney	
XXX ± 0.15	XX° ± 1°	CHECKED BY		Vito	
CUSTOMER DRAWING		DRAWN BY		XU	
SIZE	UNITS	DWG NO.		AP-ADDR0110	
A4	MM [INCH]	SHEET		4 / 5	
		SCALE		1 : 1	
		REV		K	

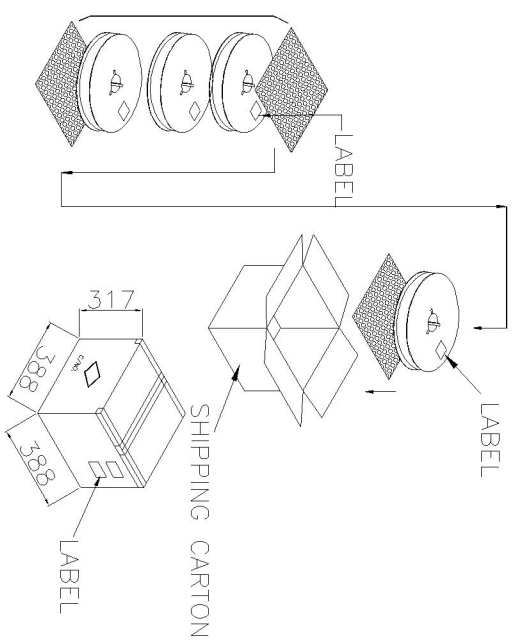
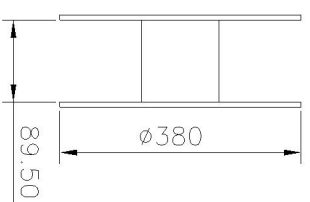
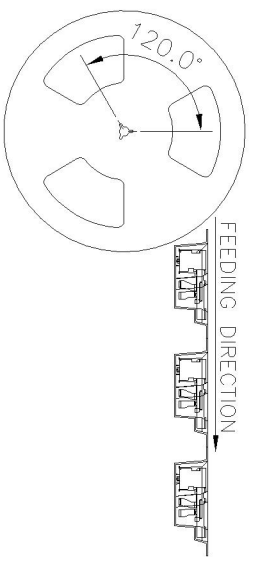
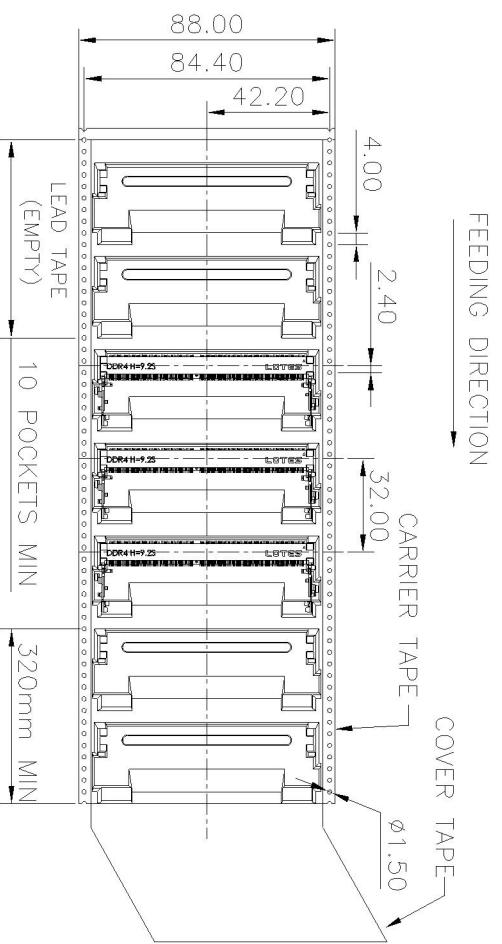

- NOTES:
- MATERIAL :
 - CARRY TAPE: PS
 - COVER TAPE: PET
 - SHIPPING CARTON: CORRUGATED FIBER
 - DIMENSION :
 - REEL: W=88.0, $\phi A=380$
 - SHIPPING CARTON: L=388, W=388, H=317 (INNER)
 - QUANTITY :
 - PRIMARY PACKING: 220 PCS/REEL
 - SECONDARY PACKING: 3 REELS/CARTON(660PCS)
 - PEELING RESISTANCE: 20gf~120gf.
 - PEELING SPEED: 300mm/minutes.

GENERAL TOLERANCES UNLESS SPECIFIED		PART NO.	深圳市连欣科技有限公司	
X ± 0.35	X ° ± 3°	ADDR0110-P001A		
.XX ± 0.25	.X ° ± 2°	APPROVED BY		
XXX ± 0.15	XX ° ± 1°	Barney		
CUSTOMER DRAWING		CHECKED BY	DWG NO.	
		V/10	AP-ADDR0110	
SIZE	UNITS	DRAWN BY		
A4	MM	XU		
			SHEET	SCALE
			5 / 5	N/A
				REV
				K

A 1 2 3 4 5 6 7 8

B

C

D

E

F