

* ROHS COMPLIANT

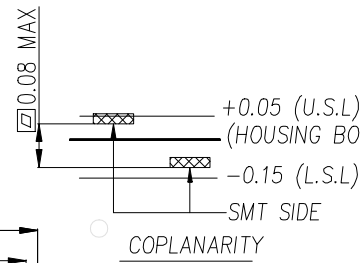

NOTES:

1. MATERIAL: SEE TABLE2. SPECIALITY:
 - 1.1 Rated current:1.0A
 - 1.2 Rated voltage: 30V
 - 1.3 Contact Resistance:50mΩ MAX
 - 1.4 Insulation Resistance:1000mΩ MIN 500V DC
 - 1.5 Dielectric withstanding voltage: 500V DC.
 - 1.6 Solder ability: 250℃±5℃, 10s±0.5s.
 - 1.7 Durability: 3000 Cycles Min.Contact Resistance50mΩMax
 - 1.8 Mating and Unmating force
 - Insertion Force 10N Max
 - Withdrawal Fore 0.5N min~10N Max
 - 1.9 Noraml Force: 30~100g(Noraml card)
 - Noraml working stroke: 0.3mm Min(Noraml card)
 - 2.0 Operating condition: Temperature-40℃~+85℃, Humidity 80% R.H MAX
2. PACKAGE: TAPE REEL PACKAGE, 1300PCS/REEL

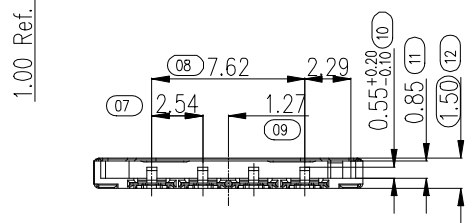
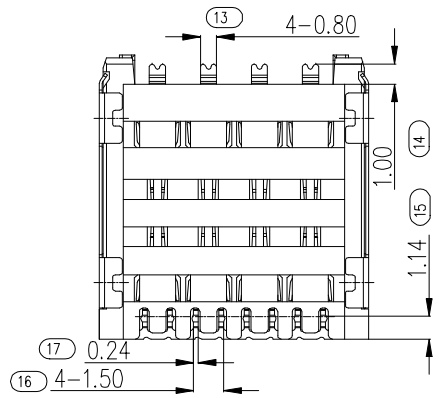
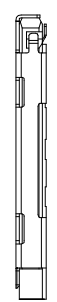
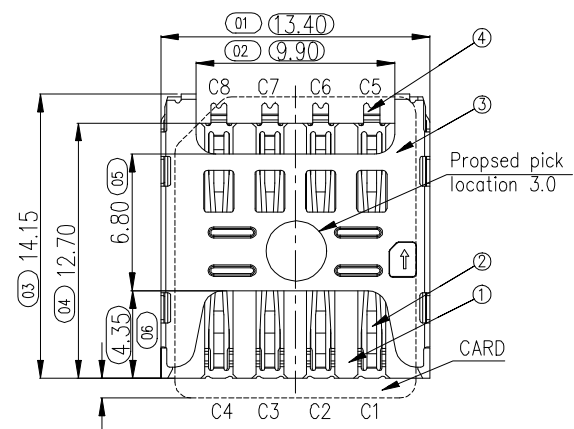
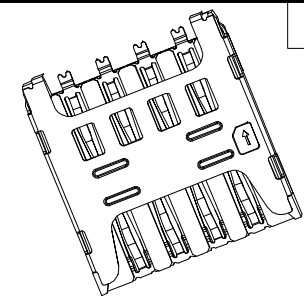
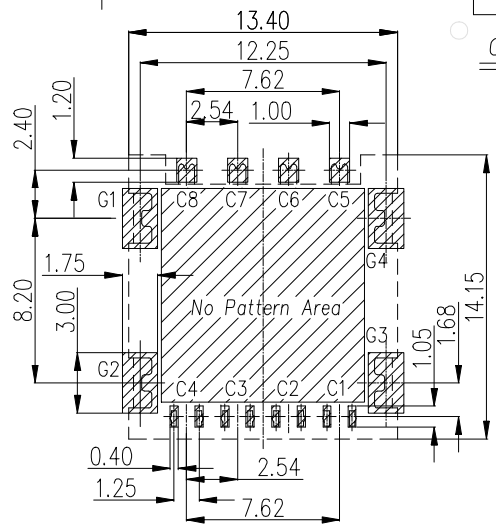
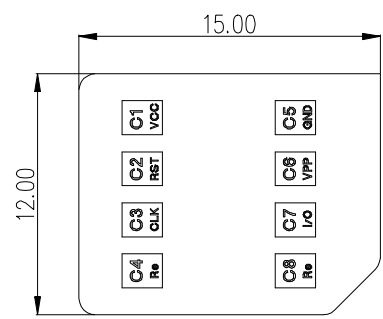

RECOMMENDED PCB LAYOUT(TOLERANCE ±0.05)
RECOMMENDED MATAL MASK T=0.12MM

连欣科技 Lian Xin Technology		<h1>深圳市连欣科技有限公司</h1>	
DIMENSIONS INIT: mm		PRODUCT NO. : XDSM-0815-2601	CHECK: AG DATE: 2014/01/15
UNLESS OTHERWISE SPECIFIABLE		DRAWING NO. : LXSM-6150008-015	APPROVED: JEFF DATE: 2014/01/15
DIMENSION TOLERANCE X.X: ± 0.38 X.XX: ± 0.25 X.XXX: ± 0.10 ANGULAR: ± 1°		SCALE: NA	DWG ID: P D REV.: A PAGE: 1 of 1

REVISION NO.	ECR NO.	DESCRIPTION	MARK	DATE
1				
2				
3				